

Integra

AV Receiver

DTM-5.3

Instruction Manual

Thank you for purchasing the Integra AV Receiver. Please read this manual thoroughly before making connections and plugging in the unit. Following the instructions in this manual will enable you to obtain optimum performance and listening enjoyment from your new AV Receiver. Please retain this manual for future reference.

Contents

Before using

Important Safeguards.....	2
Precautions	3
Features.....	4
Supplied accessories	4

Facilities and connections

Remote controller description	5
Front panel description.....	6
Rear panel description	8
Connecting components	10
Connecting speakers	12
Connecting antennas	13
Connecting the remote zone (Zone 2)	14
Operating components not reached by the remote controller signals (IR IN/OUT)	15
Connecting the power.....	16
Installing the remote controller batteries	17

Setup and operation

Basic operations	18
Receiving stations	20
Entering station names	23
Recording a source	24
Using Tape 2 Monitor	26
Enjoying music in the remote zone ...	27

Remote controller

Using the remote controller.....	28
Controlling other components	29

Appendix

Troubleshooting guide	31
Specifications	back cover page

WARNING:

TO REDUCE THE RISK OF FIRE OR ELECTRIC SHOCK, DO NOT EXPOSE THIS APPLIANCE TO RAIN OR MOISTURE.

CAUTION:

TO REDUCE THE RISK OF ELECTRIC SHOCK, DO NOT REMOVE COVER (OR BACK). NO USER-SERVICEABLE PARTS INSIDE. REFER SERVICING TO QUALIFIED SERVICE PERSONNEL.



WARNING
RISK OF ELECTRIC SHOCK
DO NOT OPEN

AVIS
RISQUE DE CHOC ELECTRIQUE
NE PAS OUVRIR



The lightning flash with arrowhead symbol, within an equilateral triangle, is intended to alert the user to the presence of uninsulated "dangerous voltage" within the product's enclosure that may be of sufficient magnitude to constitute a risk of electric shock to persons.



The exclamation point within an equilateral triangle is intended to alert the user to the presence of important operating and maintenance (servicing) instructions in the literature accompanying the appliance.

Important Safeguards

- 1. Read Instructions** – All the safety and operating instructions should be read before the appliance is operated.
- 2. Retain Instructions** – The safety and operating instructions should be retained for future reference.
- 3. Heed Warnings** – All warnings on the appliance and in the operating instructions should be adhered to.
- 4. Follow Instructions** – All operating and usage instructions should be followed.
- 5. Cleaning** – Unplug the appliance from the wall outlet before cleaning. The appliance should be cleaned only as recommended by the manufacturer.
- 6. Attachments** – Attachments not recommended by the manufacturer may create hazards. Use only recommended attachments.
- 7. Water and Moisture** – Do not use the appliance near water –for example, near a bath tub, wash bowl, kitchen sink, or laundry tub; in a wet basement; or near a swimming pool; and the like.
- 8. Accessories** – Do not place the appliance on an unstable cart, stand, tripod, bracket, or table. The appliance may fall, causing serious injury to a child or adult, and serious damage to the appliance. Use only with a cart, stand, tripod, bracket, or table recommended by the manufacturer, or sold with the appliance. Any mounting of the appliance should follow the manufacturer's instructions, and should use a mounting accessory recommended by the manufacturer.
- 9. An appliance and cart combination should be moved with care.** Quick stops, excessive force, and uneven surfaces may cause the appliance and cart combination to overturn.
- 10. Ventilation** – Slots and openings in the cabinet are provided for ventilation and to ensure reliable operation of the appliance and to protect it from overheating, and these openings must not be blocked or covered. The openings should never be blocked by placing the appliance on a bed, sofa, rug, or other similar surface. The appliance should not be placed in a built-in installation such as a bookcase or rack unless proper ventilation is provided. There should be free space of at least 20 cm (8 in.) and an opening behind the appliance.
- 11. Power Sources** – The appliance should be operated only from the type of power source indicated on the marking label. If you are not sure of the type of power supply to your home, consult your appliance dealer or local power company.
- 12. Grounding or Polarization** – The appliance may be equipped with a polarized alternating current line plug (a plug having one blade wider than the other). This plug will fit into the power outlet only one way. This is a safety feature. If you are unable to insert the plug fully into the outlet, try reversing the plug. If the plug should still fail to fit, contact your electrician to replace your obsolete outlet. Do not defeat the safety purpose of the polarized plug.
- 13. Power-Cord Protection** – Power-supply cords should be routed so that they are not likely to be walked on or pinched by items placed upon or against them, paying particular attention to cords at plugs, convenience receptacles, and the point at which they exit from the appliance.
- 14. Outdoor Antenna Grounding** – If an outside antenna or cable system is connected to the appliance, be sure the antenna or cable system is grounded so as to provide some protection against voltage surges and built-up static charges. Article 810 of the National Electrical Code, ANSI/NFPA 70, provides information with regard to proper grounding of the mast and supporting structure, grounding of the lead-in wire to an antenna-discharge unit, size of grounding conductors, location of antenna-discharge unit, connection to grounding electrodes, and requirements for the grounding electrode. See Figure 1.
- 15. Lightning** – For added protection for the appliance during a lightning storm, or when it is left unattended and unused for long periods of time, unplug it from the wall outlet and disconnect the antenna or cable system. This will prevent damage to the appliance due to lightning and power-line surges.
- 16. Power Lines** – An outside antenna system should not be located in the vicinity of overhead power lines or other electric light or power circuits, or where it can fall into such power lines or circuits. When installing an outside antenna system, extreme care should be taken to keep from touching such power lines or circuits as contact with them might be fatal.
- 17. Overloading** – Do not overload wall outlets, extension cords, or integral convenience receptacles as this can result in a risk of fire or electric shock.
- 18. Object and Liquid Entry** – Never push objects of any kind into the appliance through openings as they may touch dangerous voltage points or short-out parts that could result in a fire or electric shock. Never spill liquid of any kind on the appliance.
- 19. Servicing** – Do not attempt to service the appliance yourself as opening or removing covers may expose you to dangerous voltage or other hazards. Refer all servicing to qualified service personnel.
- 20. Damage Requiring Service** – Unplug the appliance from the wall outlet and refer servicing to qualified service personnel under the following conditions:
 - When the power-supply cord or plug is damaged
 - If liquid has been spilled, or objects have fallen into the appliance
 - If the appliance has been exposed to rain or water
 - If the appliance does not operate normally by following the operating instructions. Adjust only those controls that are covered by the operating instructions as an improper adjustment of other controls may result in damage and will often require extensive work by a qualified technician to restore the appliance to its normal operation.
 - If the appliance has been dropped or damaged in any way, and
 - When the appliance exhibits a distinct change in performance – this indicates a need for service.

PORTABLE CART WARNING



S3125A

21. **Replacement Parts** – When replacement parts are required, be sure the service technician has used replacement parts specified by the manufacturer or that have the same characteristics as the original part. Unauthorized substitutions may result in fire, electric shock, or other hazards.
22. **Safety Check** – Upon completion of any service or repairs to the appliance, ask the service technician to perform safety checks to determine that the appliance is in proper operating condition.
23. **Wall or Ceiling Mounting** – The appliance should be mounted to a wall or ceiling only as recommended by the manufacturer.
24. **Heat** – The appliance should be situated away from heat sources such as radiators, heat registers, stoves, or other appliances (including amplifiers) that produce heat.
25. **Liquid Hazards** – The appliance shall not be exposed to dripping or splashing and no objects filled with liquids, such as vases shall be placed on the appliance.

FIGURE 1:
EXAMPLE OF ANTENNA GROUNDING AS PER NATIONAL ELECTRICAL CODE, ANSI/NFPA 70

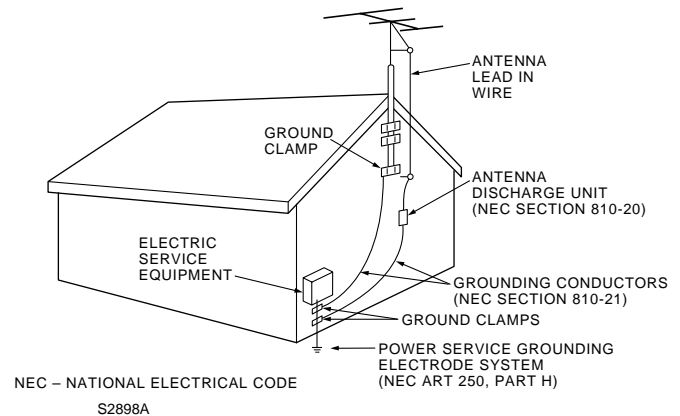

Precautions

1. Recording Copyright

Recording of copyrighted material for other than personal use is illegal without permission of the copyright holder.

2. AC Fuse

The fuse is located inside the chassis and is not user-serviceable. If power does not come on, contact your Integra/Onkyo authorized service station.

3. Care

From time to time you should wipe the front and rear panels and the cabinet with a soft cloth. For heavier dirt, dampen a soft cloth in a weak solution of mild detergent and water, wring it out dry, and wipe off the dirt. Following this, dry immediately with a clean cloth. Do not use rough material, thinners, alcohol or other chemical solvents or cloths since these could damage the finish or remove the panel lettering.

4. Power

WARNING

BEFORE PLUGGING IN THE UNIT FOR THE FIRST TIME, READ THE FOLLOWING SECTION CAREFULLY.

The voltage of the available power supply differs according to country or region. Be sure that the power supply voltage of the area in which this unit will be used meets the required voltage (e.g., AC 120 V, 60 Hz) written on the rear panel.

Setting the Standby/On button to standby does not shut off the power completely. The power cord should be removed from the AC outlet when the unit is not used for a prolonged period of time.

For U.S. model

Note to CATV system installer:

This reminder is provided to call the CATV system installer's attention to Section 820-40 of the NEC which provides guidelines for proper grounding and, in particular, specifies that the cable ground shall be connected to the grounding system of the building, as close to the point of cable entry as practical.

FCC Information for User

CAUTION:

The user changes or modifications not expressly approved by the party responsible for compliance could void the user's authority to operate the equipment.

NOTE:

This equipment has been tested and found to comply with the limits for a Class B digital device, pursuant to Part 15 of the FCC Rules. These limits are designed to provide reasonable protection against harmful interference in a residential installation. This equipment generates, uses and can radiate radio frequency energy and, if not installed and used in accordance with the instructions, may cause harmful interference to radio communications. However, there is no guarantee that interference will not occur in a particular installation. If this equipment does cause harmful interference to radio or television reception, which can be determined by turning the equipment off and on, the user is encouraged to try to correct the interference by one or more of the following measures:

- Reorient or relocate the receiving antenna.
- Increase the separation between the equipment and receiver.
- Connect the equipment into an outlet on a circuit different from that to which the receiver is connected.
- Consult the dealer or an experienced radio/TV technician for help.

For Canadian model

For models having a power cord with a polarized plug:

CAUTION: TO PREVENT ELECTRIC SHOCK, MATCH WIDE BLADE OF PLUG TO WIDE SLOT, THEN FULLY INSERT.

NOTE: THIS CLASS B DIGITAL APPARATUS COMPLIES WITH CANADIAN ICES-003.

Modèle pour les Canadien

Sur les modèles dont la fiche est polarisée:

ATTENTION: POUR ÉVITER LES CHOCS ÉLECTRIQUES, INTRODUIRE LA LAME LA PLUS LARGE DE LA FICHE DANS LA BORNE CORRESPONDANTE DE LA PRISE ET POUSSER JUSQU'AU FOND.

REMARQUE: CET APPAREIL NUMÉRIQUE DE LA CLASSE B EST CONFORME À LA NORME NMB-003 DU CANADA.

Features

- **Power output**
100 watts per channel, min RMS, at 8 ohms, both channels driven from 20 Hz to 20 kHz, with no more than 0.08% THD
- **Discrete output stage circuits for true high-current, low-impedance drive**
- **Costly, high-quality parts such as large power transistors, an oversized isolated transformer and heavy-duty extruded heat sink make it possible to accurately and effortlessly drive 4-ohm speakers (rare for a receiver)**
- **A-BUS Ready**
- **4 Audio and 2 AV inputs**
- **A-B Speaker selector and outputs**
- **Video and cassette tape dubbing capability**
- **Direct tone control**
- **40 FM/AM random presets**
- **Preset scan tuning**
- **Direct access tuning**
- **Motor-driven, precision volume control**
- **Headphone jack**
- **Audio mute, sleep timer (via remote)**
- **Battery-free rotary volume knob**
- **New non-resonant feet**
- **New slip-free rotary volume knob**
- **RI Compatible remote control**

Memory Preservation

This unit does not require memory preservation batteries. A built-in memory power back-up system preserves the contents of the memory during power failures and even when the unit is unplugged. The unit must be plugged in order to charge the back-up system.

The memory preservation period after the unit has been unplugged varies depending on climate and placement of the unit. On the average, memory contents are protected over a period of a few weeks after the last time the unit has been unplugged. This period is shorter when the unit is exposed to a highly humid climate.

Supplied accessories

Check that the following accessories are supplied with the DTM-5.3.

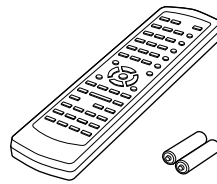

Remote controller RC-477S (1)
Batteries (AA, R6 or UM-3) (2)

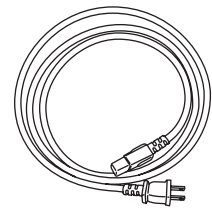

Power cord (1)

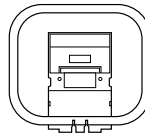

AM loop antenna (1)



FM indoor antenna (1)

Remote controller description

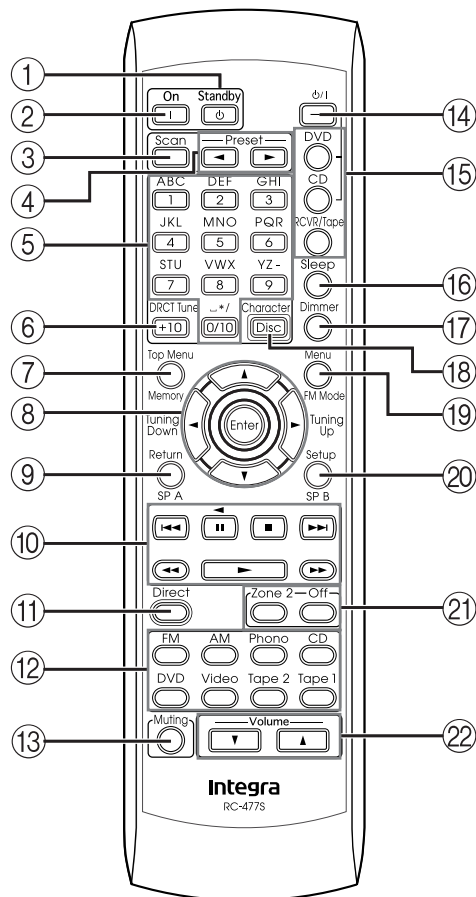

Note: When you use the buttons that apply to specific mode (i.e., DVD mode, RCVR/Tape mode, or CD mode), you must press the corresponding mode button first.

- ① **Standby (⏻) button**
This button sets the unit to Standby mode.
- ② **On (|) button**
This button turns on the power to the unit.
- ③ **Scan button**
Press this button to scan the preset channels.
- ④ **◀ Preset ▶ buttons**
These buttons enable you to select an FM/AM preset channel.
- ⑤ **Number (1–9, 0/10) buttons**
When using RCVR/Tape mode, use these buttons to program and select the radio presets.
When using CD or DVD mode, use these buttons to select tracks and chapters.
Alphabetic letters/symbols buttons (RCVR/Tape mode)
Use these buttons to name the preset channels using characters.
- ⑥ **DRCT Tune (Direct Tuning) button (RCVR/Tape mode)**
Use this button to set the frequency. After pressing this button, use the number buttons to input the frequency.
+10 button (CD or DVD mode)
This button is used as a numeric key to control the Integra/Onkyo CD or DVD player connected by using the **RI** terminals.
- ⑦ **Top Menu button (DVD mode)**
Press this button to display the top menu screen of a DVD.
Memory button (RCVR/Tape mode)
This button enables you to program or erase preset FM/AM stations.
- ⑧ **◀ / ▶ / ▲ / ▼ / Enter buttons (DVD mode)**
Use these cursor buttons to move the cursor to select an item on the display, and press the Enter button to confirm the setting.

- ⑨ **Return button (DVD mode)**
Press this button while the setup screen is displayed to go back to the previous item.
SP A button (RCVR/Tape mode)
This button switches Speaker A On or Off.
- ⑩ **Tape, CD, DVD operation buttons**
These buttons enable you to control other Integra/Onkyo products connected to the DTM-5.3 via **RI** connection.
- ⑪ **Direct button**
This button enables the function that makes the input source sound much closer to the original sound source.
- ⑫ **Input Selector buttons**
These buttons enable you to select input sources.
- ⑬ **Muting button**
This button temporarily lowers the sound volume.
- ⑭ **⏻ / | (Power) button (CD or DVD mode)**
This button switches between On and Standby mode of a DVD or CD player connected to the DTM-5.3 via the **RI** connection.
- ⑮ **Receiver/Tape, CD, DVD mode selection buttons**
These buttons enable you to select a device you wish to control from the DTM-5.3 remote controller.
- ⑯ **Sleep button**
This button sets the sleep time. If the Sleep function is set, the power to the unit will be turned off automatically after the specified time.
- ⑰ **Dimmer button**
This button sets the brightness of the display on the front panel of the unit to “Normal,” “Dark,” or “Darker.”
- ⑱ **Character button (RCVR/Tape mode)**
Press this button to name the radio stations programmed in the preset memory using characters.
Disc button (CD or DVD mode)
Use this button to select a disc to play on a connected CD or DVD changer.
- ⑲ **Menu button (DVD mode)**
Press this button to display the menu screen.
FM Mode button (RCVR/Tape mode)
Use this button to set Stereo Mode to Mono if the FM stereo radio signal being received is frequently interrupted or contains lots of noise. Pressing the button each time will toggle between AUTO and MONO for STEREO MODE.
- ⑳ **Setup button (DVD mode)**
Press this button to display or quit a setup screen.
SP B button (RCVR/Tape mode)
This button switches Speaker B On or Off.
- ㉑ **Zone 2, Off buttons**
These buttons enable you to select the source for Zone 2. To turn off the Zone 2 output, press the Off button.
- ㉒ **▼ Volume ▲ buttons**
These buttons adjust the volume level.

Front panel description

This section identifies and explains the controls and displays on the front panel of the DTM-5.3.

Front panel

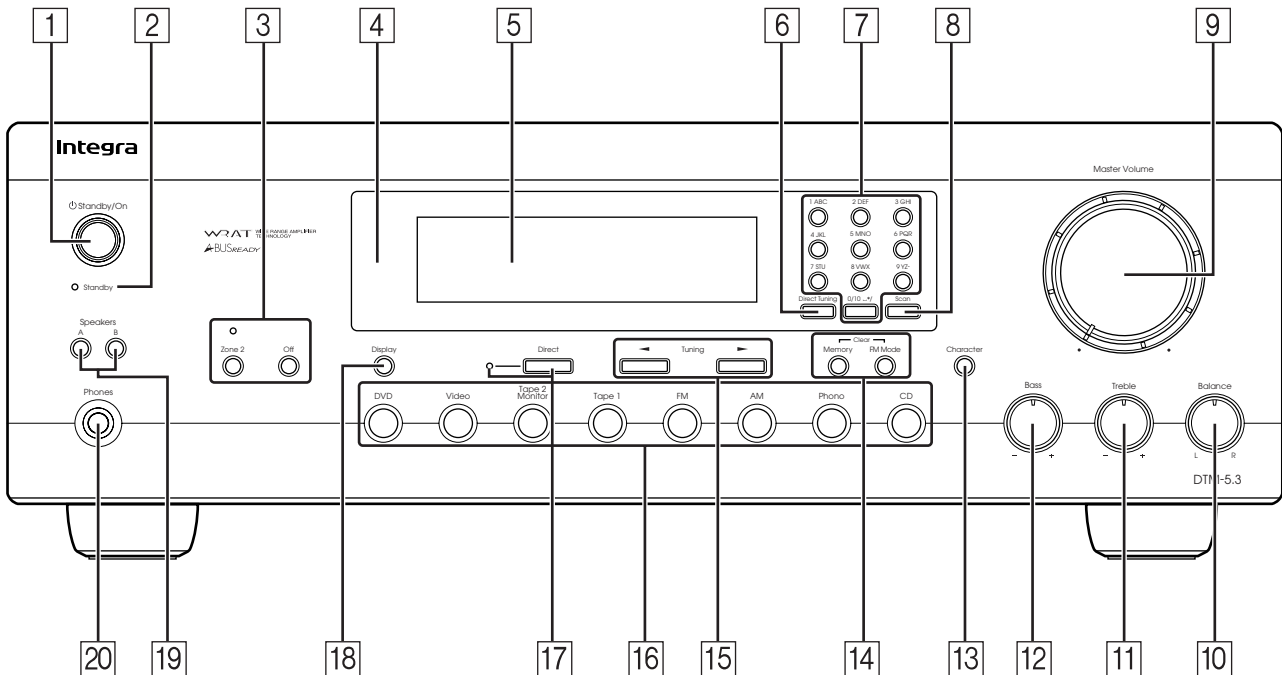

Display

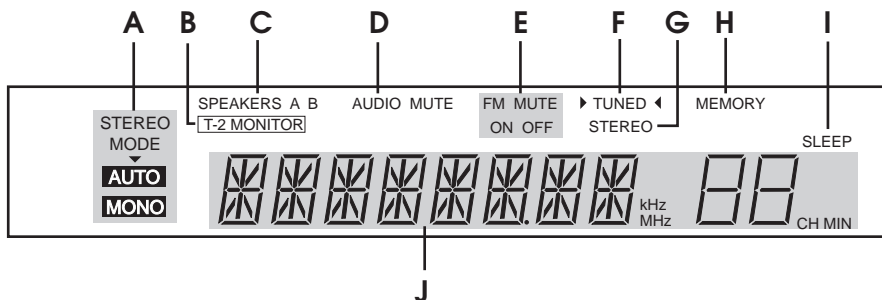

1 Standby/On button

Press this button to turn on the power to the DTM-5.3. The display indicators light up. Press the button again to set the unit in Standby mode, in which the display indicators turn off and no control on the unit is available.

If the main room device is in Standby mode, you can adjust the zone 2 room.

2 Standby indicator

This indicator lights up in Standby mode and when the unit receives a signal from the remote controller.

3 Zone 2 button and indicator, Off button

This button enables you to enjoy music in another room (Zone 2). When you press the Zone 2 button, the currently-selected playback source for Zone 2 appears on the display. If "Z2 SRC" appears, the source for Zone 2 is the same as the currently-selected playback source. To change the source for Zone 2, press the Zone 2 button, then press an input selector button within five seconds. The Zone 2 indicator lights up. To select "Z2 SRC" for Zone 2, press the Zone 2 button twice. To turn off the Zone 2 output, press the Off button. The Zone 2 indicator turns off.

4 Remote control sensor

5 Display

A. STEREO MODE, AUTO, MONO indicator

Pressing the FM Mode button each time toggles between AUTO and MONO indicators.

B. T-2 MONITOR indicator

This indicator lights up when you press the Tape 2 Monitor button, which enables you to monitor the audio signal during recording to a three-head cassette tape deck connected to the TAPE 2 jack.

C. SPEAKERS A B indicator

This indicates which speaker system you are currently using.

D. AUDIO MUTE indicator

This indicator flashes while you are using the Mute function.

E. FM MUTE ON OFF indicator

Pressing the FM Mode button each time toggles between ON and OFF.

Front panel description

F. **TUNED** indicator

This indicator lights up when the unit receives a radio station signal.

G. **STEREO** indicator

The indicator lights up when the unit receives an FM stereo radio station signal.

H. **MEMORY** indicator

The indicator lights up when you press the Memory button to program a radio station.

I. **SLEEP** indicator

This indicator lights up while the Sleep function is active.

J. **Multi function display indicator**

This display indicates the input source, frequency, preset number, and preset name.

6 **Direct Tuning button**

Use this button to set the frequency. After pressing this button, use the number buttons to input the frequency.

7 **Number (1–9, 0/10) buttons**

Use these buttons to program preset channels or select radio stations.

Alphabetic letters/symbols buttons

Use these buttons to name the preset channels using characters.

8 **Scan button**

Press this button to scan the preset channels.

9 **Master Volume dial**

This dial adjusts the volume level.

10 **Balance dial**

In general, set this dial to the center (12 o'clock) position. Adjust the dial accordingly if the left and right volume levels are not balanced, depending on the speaker position or listening position. Turn the dial clockwise to pan the stereo position to the right, and turn it counterclockwise to pan to the left.

11 **Treble dial**

This dial adjusts the high range of the left and right speakers. Turning the dial to the right from the center position will emphasize the high range, and turning it to the left will attenuate the high range.

12 **Bass dial**

This dial adjusts the low range of the left and right speakers. Turning the dial to the right from the center position will emphasize the low range, and turning it to the left will attenuate the low range.

13 **Character button**

Press this button to name the radio stations programmed in the preset memory using characters.

14 **Memory, FM Mode buttons**

Memory

Memory button enables you to program or erase preset FM/AM stations.

FM Mode

Use FM Mode button to set Stereo Mode to Mono if the FM stereo radio signal being received is frequently interrupted or contains lots of noise. Pressing the button each time will toggle between AUTO and MONO for STEREO MODE.

Clear

To erase the programmed stations, hold down the Memory button, then press the FM MODE button.

15 **Tuning buttons**

Use these buttons to change the tuner frequency. The tuner frequency is displayed in the front display. It can be changed in 100 kHz increments for FM and 10 kHz increments for AM.

When FM is selected, you can hold down one of the tuning buttons and then release it to activate the auto-search feature. It will search for a station in the direction of the button you pressed and stop when it tunes one in.

16 **Input selector buttons**

These buttons enable you to select input sources.

To select input sources for the Zone 2 device, first press the Zone 2 button, then press an Input selector button.

17 **Direct button and indicator**

This button enables the function that makes the input source sound much closer to the original sound source. When you press this button, the indicator lights up, and the input source signal bypasses the Bass and Treble control circuits. In this way, the audio sounds more real and true to the original source.

To cancel this function, press this button again.

18 **Display button**

This button switches the display indication between the frequency value and the channel name if the FM and AM preset channels have been named.

19 **Speakers A, B buttons**

These buttons turn speaker systems A and B On and Off.

20 **Phones**

Connect a stereo headphone set to this standard stereo jack. Audio signals to the left and right speakers will be output to the headphones.

Rear panel description

This section identifies and explains how to use the terminals found on the rear of the DTM-5.3. Before connecting your audio and video components, be sure to read this section carefully and then proceed to the explanations on how to connect each individual component (see page 10).

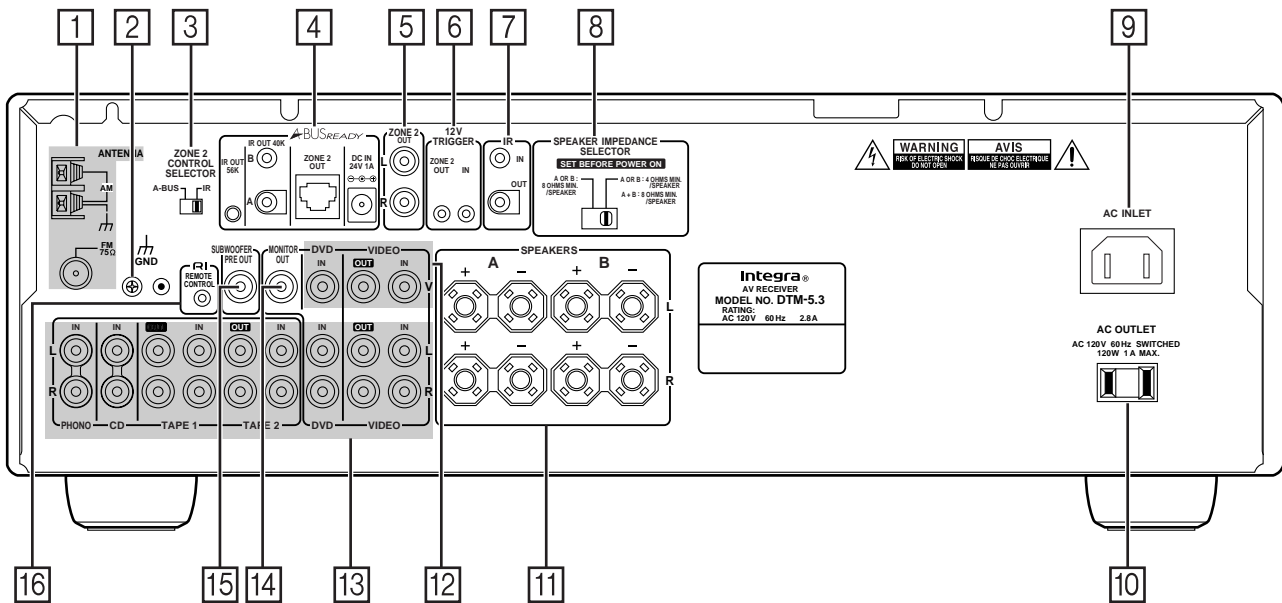

1 ANTENNA
These connectors enable you to connect the FM indoor antenna and AM loop antenna supplied with the DTM-5.3.

2 GND
Use this GND terminal to connect the ground (or earth) wire if a turntable is connected. Refer to "Connecting components" on page 10.

3 ZONE 2 CONTROL SELECTOR
This switch enables you to select whether the Zone 2 function is controlled from the A-BUS system or from the IR system. Sliding the switch to the left will select A-BUS system control, and sliding it to the right will select IR system control.

4 A-BUS READY
A-BUS is a simple, efficient, elegant audio distribution system. The wiring installation time is significantly reduced as only a single CAT-5 wire is run to each location. A-BUS is easy to use, reliable, affordable, and most of all, far better sounding than conventional auto former based volume controls.

ZONE 2 OUT: Use a CAT-5 (eight conductor twisted) cable to connect directly from the receiver's A-BUS RJ45 Hub to an A-BUS keypad. A-BUS outputs enable connection of up to four A-BUS keypads.

Warning:
DO NOT connect ZONE 2 OUT to any computer or network connections (i.e., Ethernet). It will damage the computer or network components since 24-volt power runs on this cable to power the amplifier stages of the amplifier module.

IR OUT: Another feature of the A-BUS system is the ability to control source equipment in a room other than where the A-BUS module is installed. If you wish to control another source from the receiver at the A-BUS keypad by remote control, connect the A-BUS or another brand IR emitter on the receiver's 40 K terminal. Then place the emitter on the remote receiver on the front panel.

Typically, the emitter will work when you connect with a 40 K connector. If it does not work, try a 56 K connector.

DC INPUT: Connect the A-BUS power supply. Do not use any other AC Adapter on this connector as it may cause severe damage to the receiver.

Note:
Don't insert an A-BUS connector while Zone 2 or DTM5.3 is on.

5 ZONE 2 OUT
Connect the device that will be used in the remote zone (Zone 2). For more information on making the connections, refer to "Connecting the remote zone (Zone 2)" on page 14.

6 12V TRIGGER ZONE 2 OUT, IN terminal
These terminals are provided so that you can use the DTM-5.3 to control another externally-connected device. Connect the component to this 1/8-inch mini-jack terminal. When the set input source is selected, the device will turn on. Set the 12V TRIGGER terminal using the Zone 2 mode. When the DTM-5.3 is in Zone 2 mode, this terminal outputs at 12 V/100 mA.



7 IR IN/OUT
If the DTM-5.3 is located inside a rack or cabinet that will not allow infrared beams to reach the IR sensor, you will need to connect a remote sensor to IR IN input to be able to use the remote controller. Then install the remote sensor in an unblocked location at which you can easily point the remote controller. Using a mini-jack connector, connect the IR emitter to the IR OUT terminal on the DTM-5.3 and then place the IR emitter on the remote sensor of the component or facing it. Refer to "Operating components not reached by the remote controller signals (IR IN/OUT)" on page 15.

8 SPEAKER IMPEDANCE SELECTOR
The DTM-5.3 provides two speaker system connections (SPEAKER A and SPEAKER B). Set the SPEAKER IMPEDANCE SELECTOR according to the impedance of speakers to be connected.

Warning:
Do not plug in the power cord during speaker system connection and operation of the SPEAKER IMPEDANCE SELECTOR.

Rear panel description

Depending on the impedance of the speakers used, set the **SPEAKER IMPEDANCE SELECTOR** on the rear panel as shown in the table.

Usable speaker impedance	Selector position
A or B speaker 4 ohms or higher/speaker	
A and B speakers 8 ohms or higher/speaker	
A or B speaker 8 ohms or higher/speaker	

9 AC INLET

Plug the supplied power cord into this **AC INLET** and then into the power outlet on the wall.

- Do not use a power cord other than the one supplied with the DTM-5.3. The power cord supplied is designed for use with the DTM-5.3 and should not be used with any other device.
- Never disconnect the power cord from the DTM-5.3 while the other end is plugged into a wall outlet. Doing so may cause an electric shock. Always connect by plugging into the wall outlet last and disconnect by unplugging from the wall outlet first.

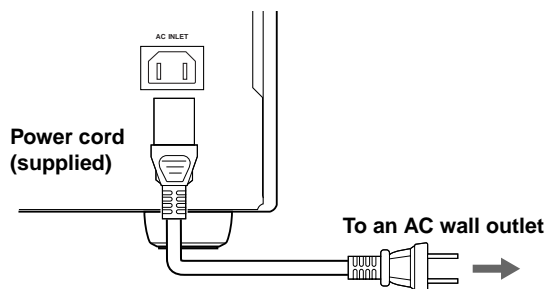

10 AC OUTLET

The DTM-5.3 is supplied with AC mains outlet for connecting the power cords from other devices so that their power is supplied through the DTM-5.3. By doing this, you can use the Standby/On button on the DTM-5.3 to turn on and off the connected devices as well.

Caution:

Make sure that the capacity of the other components connected to this unit does not exceed the 120 watts.

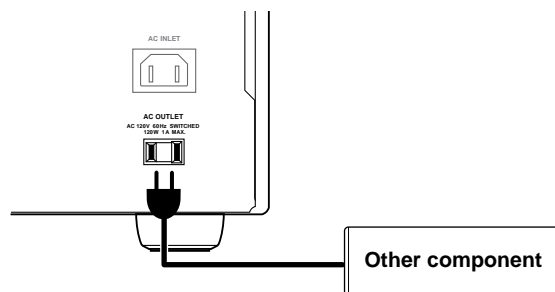

11 SPEAKERS terminals

Connect the left and right speakers here.

12 VIDEO IN/OUT

The DTM-5.3 provides two video inputs and one video output. Connect a DVD player, VCR, or other video player to the input and connect a VCR or other video recorder to the output.

13 AUDIO IN/OUT

There are 6 audio inputs and 3 audio outputs for use with analog signals. The audio inputs and outputs require RCA type connectors.

- When connecting a VCR or other video component, make sure you connect the audio and video leads together (i.e., both to VIDEO).
- The PHONO jacks are designed for use with turntables that use moving magnet cartridges.

14 MONITOR OUT

This output enables you to connect to a television monitor.

15 SUB WOOFER PRE OUT

This terminal enables you to connect to an active subwoofer.

Note: The subwoofer can only operate when speaker system A is turned on.

16 RI REMOTE CONTROL

The **RI** terminal on the DTM-5.3 enables you to connect to other Integra/Onkyo components equipped with the same **RI** terminal. When a component is **RI**-connected, you can point the remote controller supplied with the DTM-5.3 at the sensor on the DTM-5.3 and operate that component without having to switch remote controllers.

In addition, by connecting components to the **RI** terminal, you can also perform the system operations given below.

Power on/ready function

When the DTM-5.3 is in Standby mode, if an **RI**-connected component is turned on, then the DTM-5.3 also turns on and the input source selected at the DTM-5.3 automatically switches to that component.

If the power cord for an **RI**-connected component is connected to the **AC OUTLET** on the DTM-5.3, or if the DTM-5.3 is turned on, this function will not work.

Direct change function

When the play button is pressed on an **RI**-connected component, the input source selected at the DTM-5.3 automatically changes to that component.

Power off function

When the DTM-5.3 is placed in Standby mode, all **RI**-connected components are also automatically placed in Standby mode.

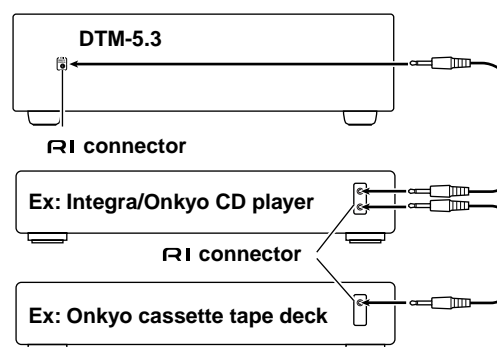

To connect components using the **RI** terminal, simply connect a remote control cable from this **RI** terminal to the **RI** terminal of the other component. An **RI** remote control cable with a 1/8-inch (3.5mm) miniature two-conductor plug comes with every cassette tape deck, compact disc player, MD recorder, and DVD player that has an **RI** terminal.

- When performing operations with **RI**-connected components using the **RI** system, do not use the remote zone (Zone 2).
- For remote control operation, the audio connection cables must also be connected.
- If a component has two **RI** terminals, you can use either one to connect to the DTM-5.3. The other one can be used to daisy chain to another component.

Connecting components

This section explains how to connect the main components to the DTM-5.3 in the standard manner.

- Be sure to always refer to the instruction manual that came with the component that you are connecting.
- Do not plug in the power cord until all connections have been made.
- For input jacks, red connectors (marked R) are used for the right channel, white connectors (marked L) are used for the left channel, and yellow connectors (marked VIDEO) are used for video connection.
- Insert all plugs and connectors securely. Improper connections can result in noise, poor performance, or damage to the equipment.

- Do not bind audio connection cables with power cords and speaker cables. Doing so may adversely effect the sound quality.

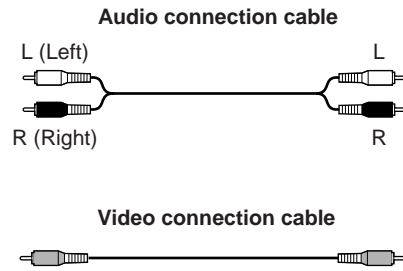
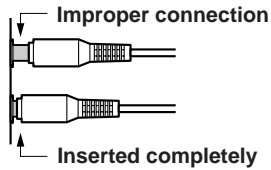

Example of audio equipment connection

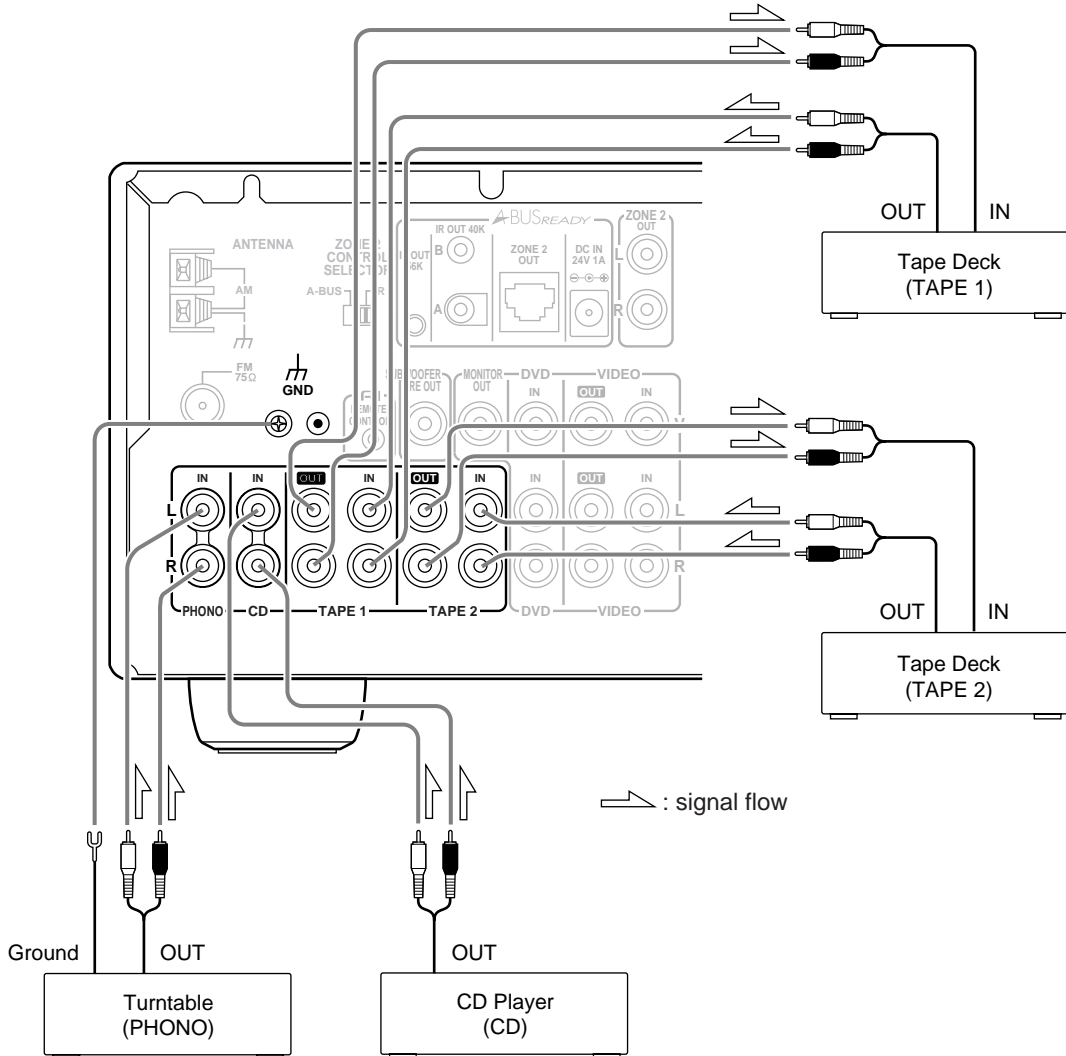

Connecting components

Example of video equipment connections

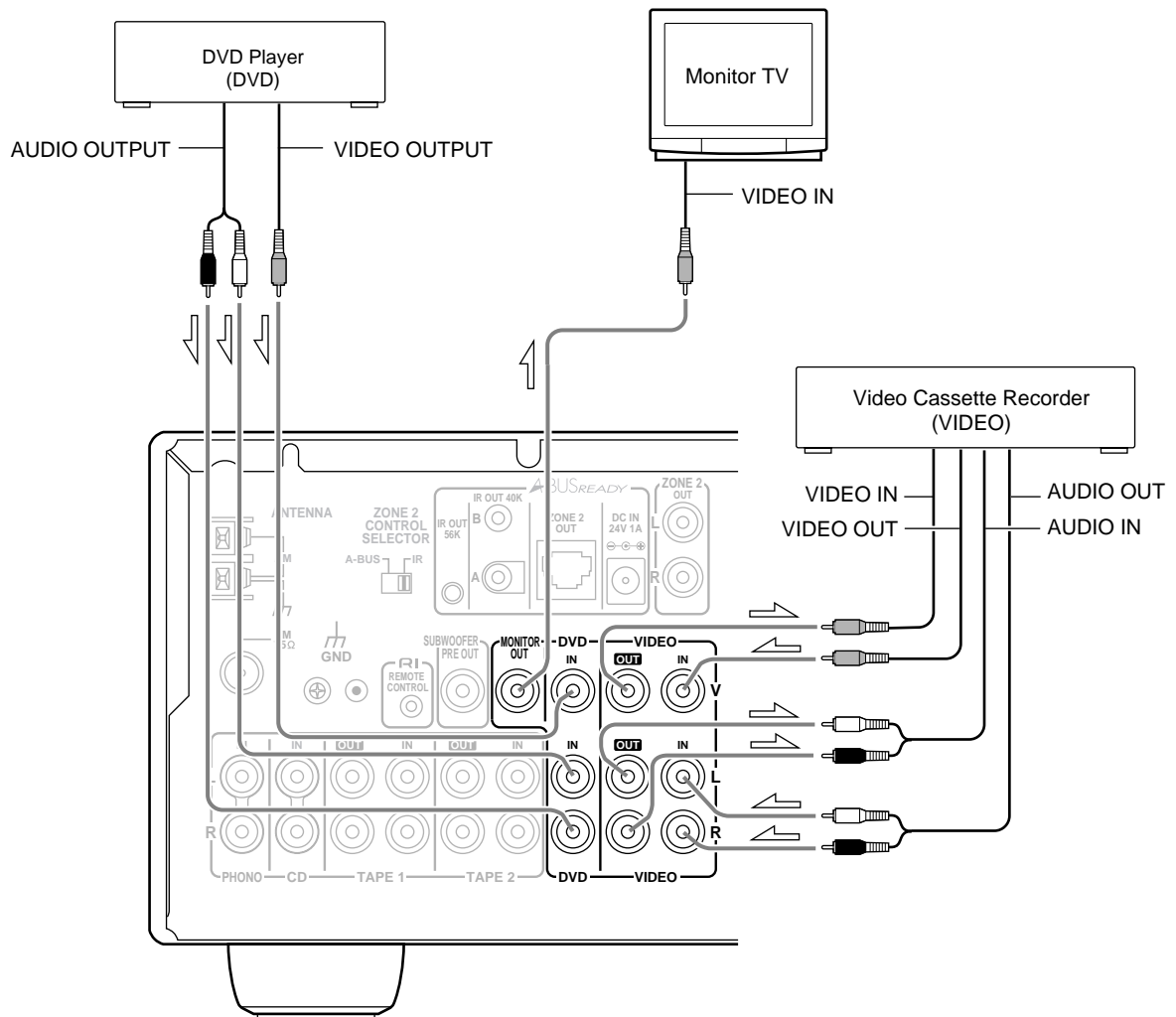

If there should be interference between the TV and this unit, place this unit as far from the TV as possible.
We do not recommend the use of a common TV/FM antenna. (Refer to "Connecting antennas" on page 13.)

Connecting speakers

Connecting the speaker

You can connect two separate pairs of speaker systems. Please connect each speaker according to the illustration, observing the correct connections for R, L, + and -.

Check the speaker impedance, then set the SPEAKER IMPEDANCE SELECTOR switch accordingly. Refer to pages 8 and 9 for details.

Notes:

- Do not use unnecessarily long or extremely thin speaker leads. If the DC resistance of the speaker leads is too high, the damping factor will decrease, adversely affecting the sound quality.
- When you are using only one speaker or when you wish to listen to monaural (mono) sound, a single speaker should never be connected in parallel to both the right and left-channel terminals simultaneously.

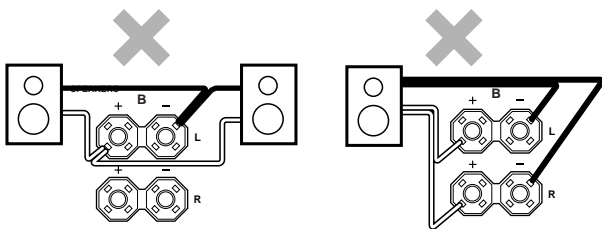

- To prevent damage to circuitry, never short-circuit the positive (+) and negative (-) speaker wire.
- Be sure to connect the positive and negative cables for the speakers properly. If they are connected to the wrong terminal, the left and right signals will be reversed and the audio will sound unnatural.
- Do not connect more than one speaker cable to one speaker terminal. Doing so may damage the DTM-5.3.

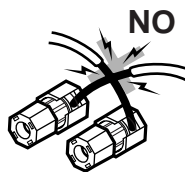

Connecting the speaker cable

- Strip away 5/8 inch (15 mm) of wire insulation.
- Twist wire ends very tight.
- Unscrew.
- Insert wire.
- Screw.

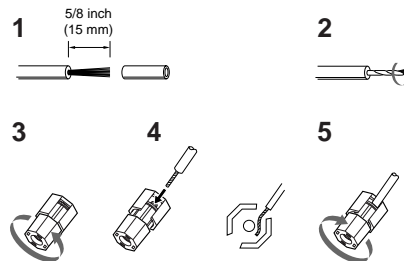

Connecting a subwoofer

Use the SUBWOOFER PRE OUT jack to connect a subwoofer with a built-in power amplifier. If your subwoofer does not have a built-in amplifier, connect an amplifier to the PRE OUT SUBWOOFER jack and the subwoofer to the amplifier.

Note:

The SUBWOOFER PRE OUT can only operate when speaker system A is turned on.

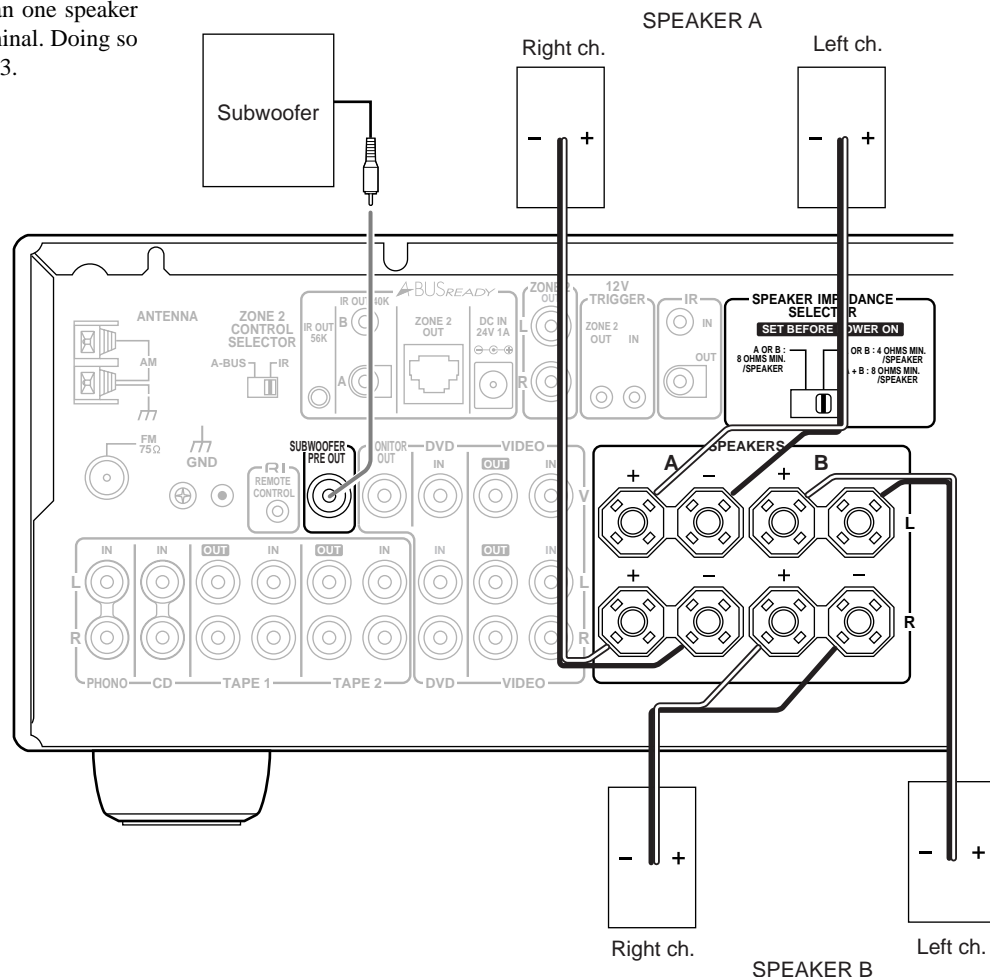

Connecting antennas

To use the tuner of the DTM-5.3, it is necessary to prepare the supplied FM and AM antennas.

- Adjustment and placement of the FM and AM antennas for better reception is best performed while listening to a station broadcast.
- If better reception cannot be obtained, then placement of an outside antenna is recommended.

Assembling the AM loop antenna

Assemble the loop antenna as shown in the illustration.

- Refer to "Connecting the AM loop antenna" below for details on connecting the loop antenna.

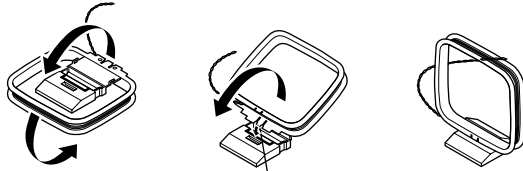

Insert into the hole.

Connecting the AM antenna cable

1. Push the lever.
2. Insert the wire into the hole.
3. Release the lever.

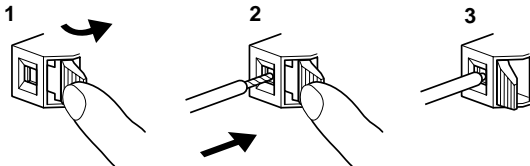

Connecting the included antennas

Connecting the FM indoor antenna:

The FM indoor antenna is for indoor use only. During use, extend the antenna and move it in various directions until the clearest signal is received. Fix it with push pins or similar implements in the position that will cause the least amount of distortion.

If the reception is not very clear with the attached FM indoor antenna, the use of an outdoor antenna is recommended.

Connecting the AM loop antenna:

The AM loop antenna is for indoor use only. Set it in the direction and position in which you receive the clearest sound. Locate it as far away as possible from the DTM-5.3, televisions, speaker cables, and power cords.

When reception is not satisfactory with the attached AM loop antenna alone, connection of an outdoor antenna is recommended.

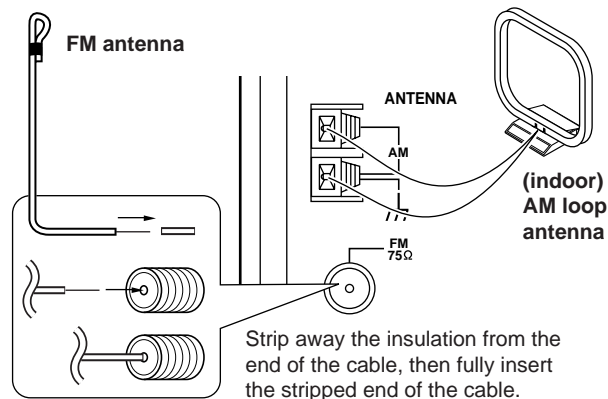

Hint:

Either of the split ends of the AM antenna can be connected to either terminal. Unlike speaker cabling, there is no polarity for AM broadcast signals.

Connecting an FM outdoor antenna

Please make sure that you follow these guidelines:

- Keep the antenna away from noise sources (neon signs, busy roads, etc.).
- It is dangerous to locate the antenna close to power lines. Keep it well away from power lines, transformers, etc.
- To avoid the risk of lightning and electrical shock, grounding is necessary. Follow item 14 of the "Important Safeguards" on page 2 when you install the outdoor antenna.

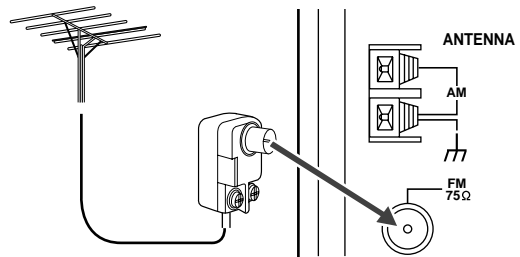

Connecting an AM outdoor antenna

An outdoor antenna will be more effective if it is stretched horizontally above a window or outside.

- Do not remove the AM loop antenna.
- To avoid the risk of lightning and electrical shock, grounding is necessary. Follow item 14 of the "Important Safeguards" on page 2 when you install the outdoor antenna.

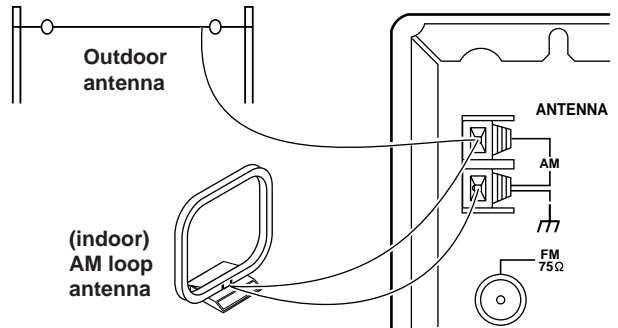

Directional linkage

Do not use the same antenna for both FM and TV (or VCR) reception since the FM and TV (or VCR) signals can interfere with each other. If you must use a common FM/TV (or VCR) antenna, use a directional linkage type splitter.

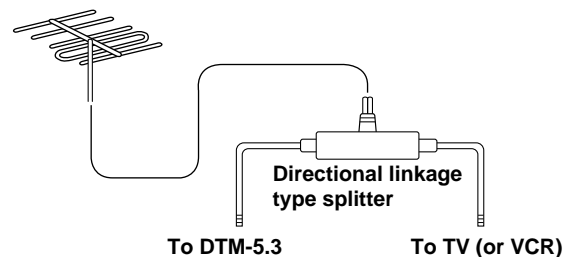

Connecting the remote zone (Zone 2)

The DTM-5.3 allows you to connect an additional set of speakers and place them in a different room or an area separated for listening to music. This other room or area is referred to as the remote zone (Zone 2), while the room in which the DTM-5.3 is referred to as the main zone. In addition, the IR IN/OUT allows you to control the DTM-5.3 from the remote zone (Zone 2) using the remote controller, even though the remote zone may be physically separated. The diagram illustrates the proper connections for the remote zone.

Zone 2 connections

The ZONE 2 OUT terminal provides constant output. Connect to the LINE input of the amplifier (CD, tape, etc.). Adjust the volume with the amplifier connected to the ZONE 2 OUT terminal.

- 1 Connect the DTM-5.3 to the amplifier for the remote zone.
- 2 Connect the remote zone speaker cables to the speaker terminals on the amplifier.

Adjust the volume level at the amplifier.

Zone 2 Control Selector

When you use the A-BUS system, switch the ZONE 2 CONTROL SELECTOR to A-BUS (left side). When you use an IR controller, switch the Zone 2 CONTROL SELECTOR to IR (right side).

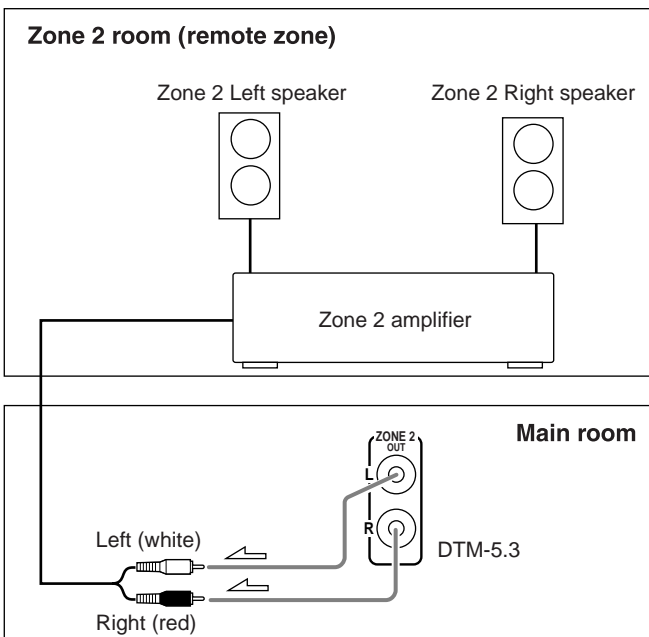

Operating components not reached by the remote controller signals (IR IN/OUT)

The following equipment (sold separately) is essential for operation:

- Onkyo's Multi-Room System kits (IR Remote Controller Extension System), or
- Multiroom A/V distribution and control systems from Niles® and Xantech® to name a few.

Controlling the DTM-5.3 in the main room from a remote zone (Zone 2)

The IR IN input allows you to control the DTM-5.3 from a remote zone (Zone 2) using the remote controller, even though the remote zone may be physically separated. The diagram below illustrates how to make the proper connections for the remote zone.

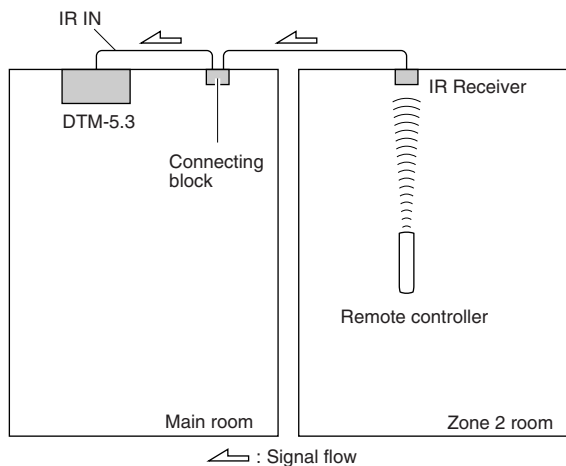

Make connection as shown below. Do not plug the equipment into the power source until the connection is completed.

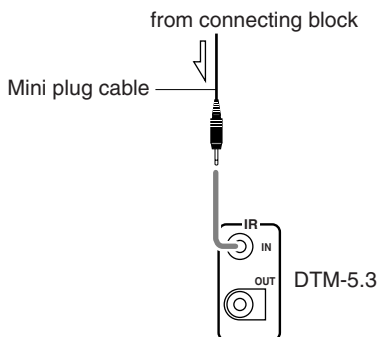

Controlling another component in the main room via the DTM-5.3 from a remote zone (Zone 2)

In this situation, you will need to use a commercially-available IR emitter. Connect the mini plug of the IR emitter to the IR OUT terminal on the DTM-5.3. Then place the IR emitter on the remote sensor of the component or facing it. When the IR emitter is connected, only the signal input to the IR IN terminal is output to the IR OUT terminal. The signal input from the remote sensor on the front of the DTM-5.3 will not be output to the IR OUT terminal.

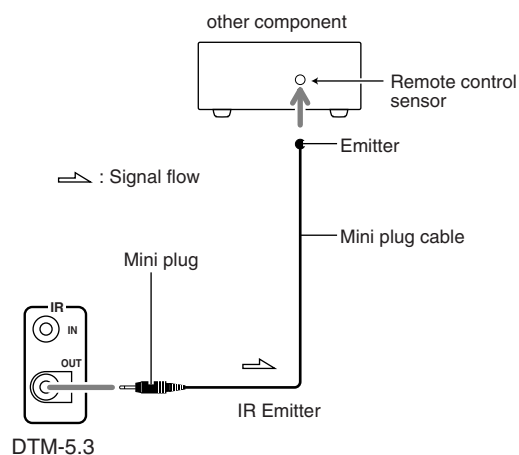
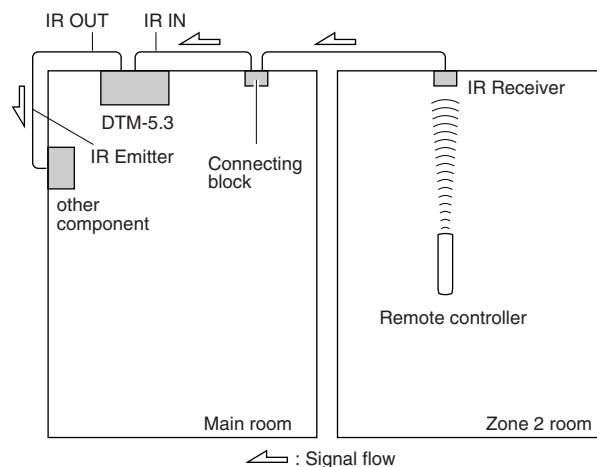

Installing the remote controller batteries

Installing the batteries

- 1 Open the battery compartment cover by pushing the tab and opening the cover.

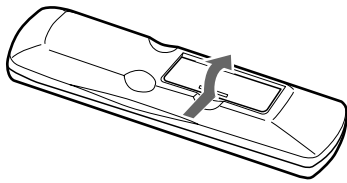

- 2 Insert two AA (R6 or UM-3) batteries into the battery compartment. Carefully follow the polarity diagram (positive (+) and negative (-) symbols) inside the battery compartment.

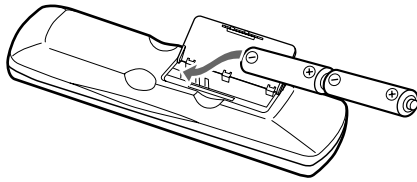

- 3 After batteries are installed and seated correctly, replace the compartment cover.

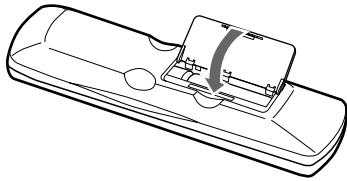

Notes:

- Do not mix new batteries with old batteries or different kinds of batteries.
- To avoid corrosion, remove the batteries if the remote controller is not to be used for a long time.
- Remove dead batteries immediately to avoid damage from corrosion. If the remote controller does not operate smoothly, replace both the batteries at the same time.

Remote controller operation

Point the remote controller toward the remote control sensor. The Standby indicator lights up when the unit receives a signal from the remote controller.

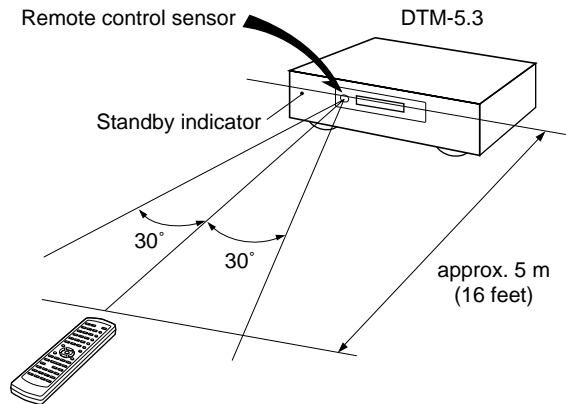

Notes:

- Place the unit away from strong light such as direct sunlight or inverted fluorescent light, which can prevent proper operation of the remote controller.
- Using another remote controller of the same type in the same room or using the unit near equipment that uses infrared rays may cause operational interference.
- Do not put objects on the remote controller. Its buttons may be pressed by mistake and drain the batteries.
- Make sure the audio rack doors do not have colored glass. Placing the unit behind such doors may prevent proper remote controller operation.
- If there is any obstacle between the remote controller and the remote control sensor, the remote controller will not operate.

Basic operations

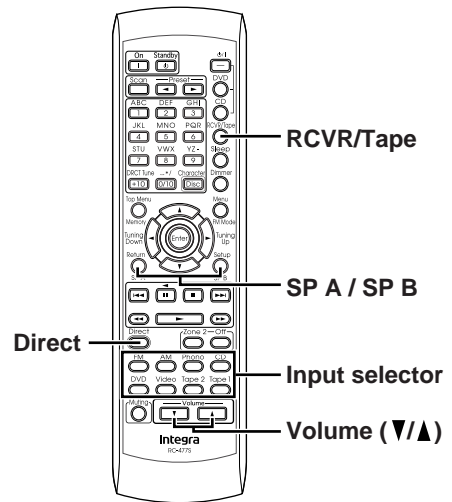
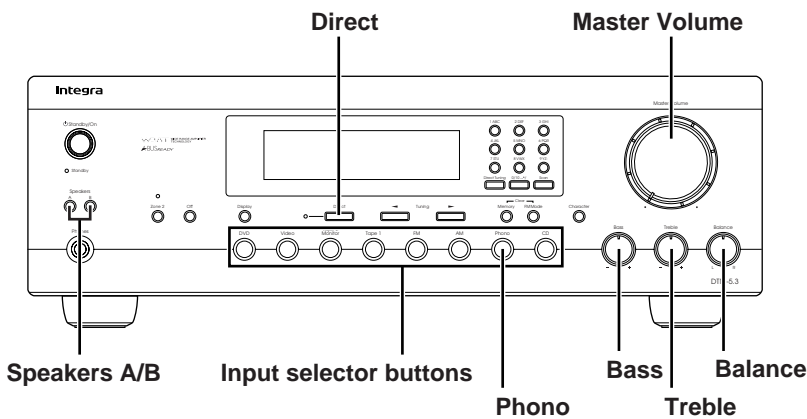

Listening to your favorite source

1 Select the source you wish to listen to using the input selector (e.g., PHONO).

Confirm that the **T-2 MONITOR** indicator is not lit when a source other than Tape 2 Monitor is selected. Also check that the **AUDIO MUTE** indicator is not lit.



2 Select the speakers.

Press the button for the speakers to which you wish to listen (Speakers A and/or B). For the remote controller, press the RCVR/Tape mode button before pressing the SP A or SP B button.

The corresponding A and/or B indicator lights up on the display panel. You will hear from the speakers any sounds passing through the unit. If both Speakers (A and B) are set to OFF, the speakers will emit no sound.

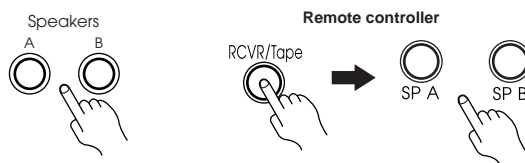

3 Start playing the selected input source.

Follow the operating instructions for the selected unit. If you select FM or AM, refer to "Receiving stations" on page 20.

4 Adjust the level.

Turn the Master Volume knob clockwise or press the ▲ button on the remote controller to increase the volume level. Turn the knob counterclockwise or press the ▼ button on the remote controller to decrease the volume level.

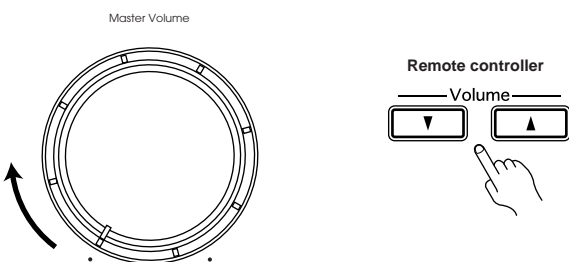

5 Adjust to your desired tone.

Bass: Turn clockwise to boost or counterclockwise to attenuate the bass.

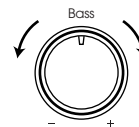

Treble: Turn clockwise to boost or counterclockwise to attenuate the treble.

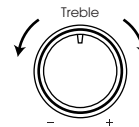

6 The Balance knob controls the relative volume level of the left and right speakers or headphones.

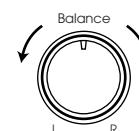

Notes:

- The power does not shut off completely when you turn off the power. The power cord should be removed from the AC wall outlet when not in use for a prolonged period of time.
- You cannot adjust the bass and treble when the **Direct** button is turned on.

Direct change function

When a compact disc player and tape deck that feature **RI** jacks are connected together, you can use the direct change function.

When you operate the compact disc player or tape deck, the input selector on the DTM-5.3 switches automatically to the desired component.

It is not necessary to switch the DTM-5.3's input selector when you change listening sources.

Note:

This direct change function does not work when Zone 2 is being controlled.

Basic operations

Listening using the headphones

You can connect stereo headphones with a standard binaural (stereo) plug to the Phones jack.

When the headphone plug is inserted, the speakers are not automatically muted but can be controlled using the Speakers A/B buttons.

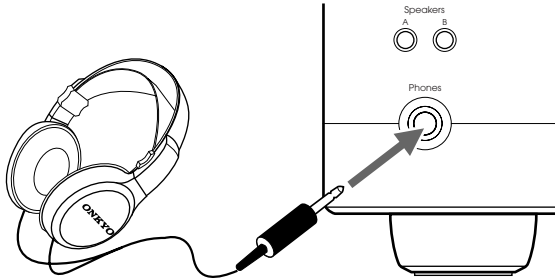

Mute function (Remote controller only)

To temporarily switch off the sound from the speakers or headphones, press the Muting button on the remote controller.

The AUDIO MUTE indicator will flash.

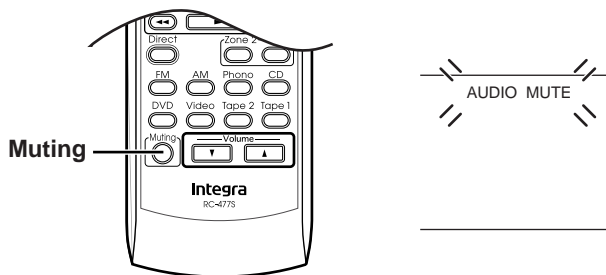

The muting function will be cancelled if you:

- press the Muting button again, or
- turn the power off, then on again.

Sleep function (Remote controller only)

The sleep timer can power off the system after a specified time period.

To operate this function, use the remote control supplied with your DTM-5.3.

- 1 Start playing the source you would like to listen to CD, tape or radio broadcast.
- 2 Set the amount of time after which you want the system to turn off.

The sleep timer works for up to 90 minutes. You can shorten the timer by 10 minute increments by pressing the Sleep button until the desired time has been reached.

After the set time passes, the power switches off automatically.

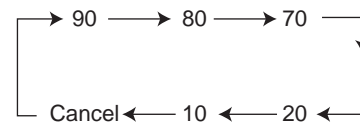
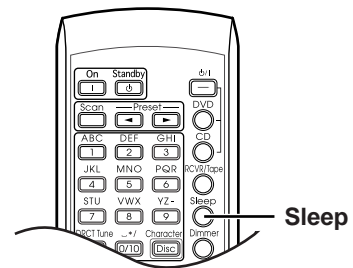

The timer will be cancelled if you:

- press the Sleep button until it changes to the display of the source to which you are listening, or
- turn off the power while the timer is operating.

Receiving stations

Please make sure that the **T-2 MONITOR** and **AUDIO MUTE** indicators are not lit.

For the remote controller, press the **RCVR/Tape** mode button before performing the procedure in this section.

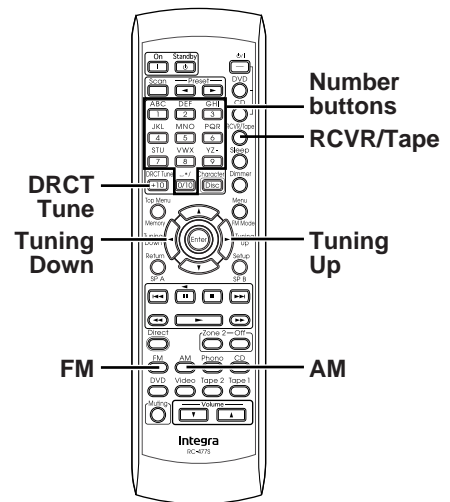
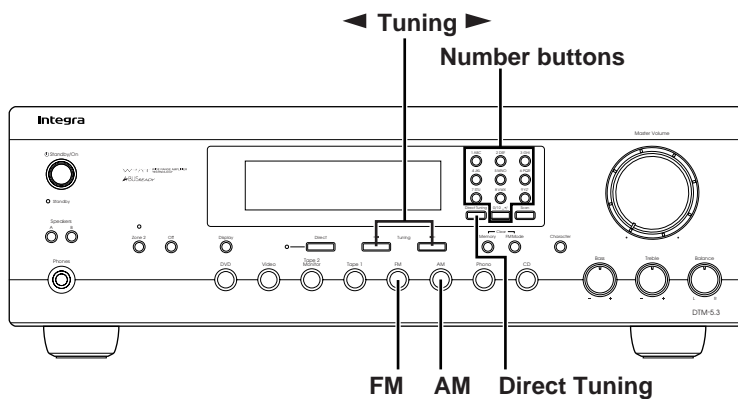

Tuning the radio (Manual tuning)

When the frequency is not known (Manual tuning)

1 Press the **FM** or **AM** button.



2 Use the **◀ Tuning ▶** buttons (or **Tuning Down** and **Up** buttons on the remote controller) to change the frequency.

▶ (Up).....the frequency increases.

◀ (Down).....the frequency decreases.

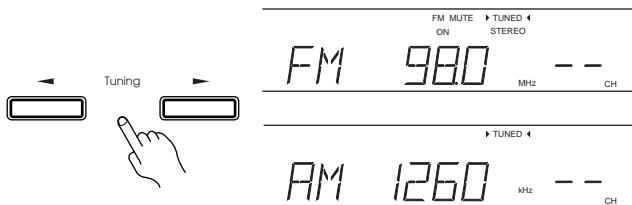

- The frequency is changed in 100 kHz steps in FM and 10 kHz in AM each time a tuning selector button is pressed.
- If a button is held continuously for more than 0.5 seconds, the frequencies are scanned automatically (FM auto tuning mode). When a broadcast is received, scanning stops.

Tuning the radio (Direct tuning)

When the frequency is known (Direct tuning)

1 Press the **FM** or **AM** button.



2 Press the **Direct Tuning** button (or **DRCT Tune** button on the remote controller).

The "-- --" will flash for 16 seconds in the frequency display.

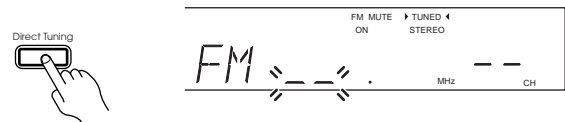

3 Enter the frequency by pressing the number buttons while the cursors are flashing.

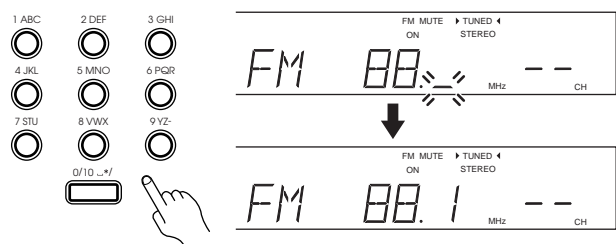

Example: 88.1MHz 8 → 8 → 1

- If you enter a frequency that is out of range, the unit will return to the previous frequency. If this happens, repeat the procedure.

Receiving stations

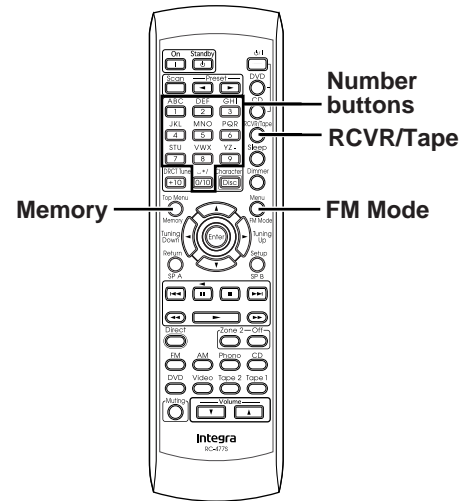
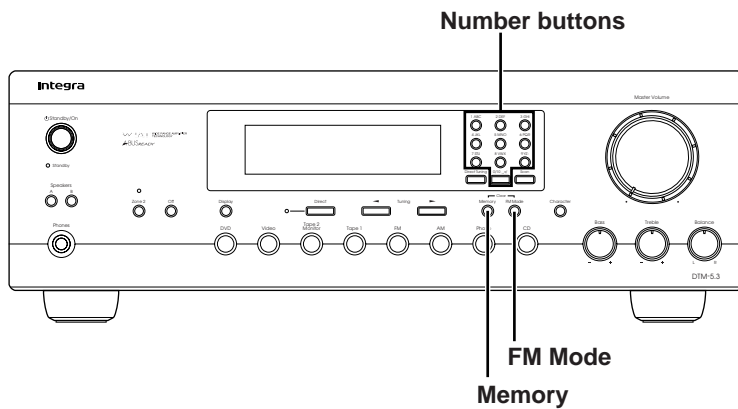

Listening to stereo radio stations (FM only)

If you tune in a stereo FM station, the STEREO indicator will be illuminated if the signal is sufficiently strong.

If the signal is weak, it may be impossible to tune in the desired station. In this case, tune as follows:

Press the FM Mode button. FM MUTE OFF lights up. At this time, the station will be received in mono and noise will be heard.

Select the station to which you wish to listen.



If the MONO indicator lights up while a station is tuned in, the station will be received in mono even if it is a stereo station.

You can change the STEREO MODE AUTO/MONO settings by pressing the FM MODE button.

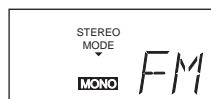

Programming radio stations

A total of 40 stations can be stored in the memory.

- 1 Select the frequency that you wish to store in memory. (Refer to "Tuning the radio" on page 20.)



- 2 Press the Memory button.

The MEMORY indicator will light for 8 seconds.

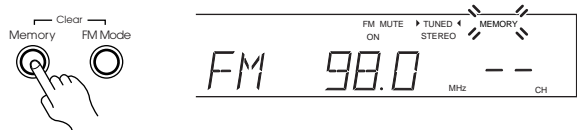

- 3 Select the desired memory number using the number buttons.

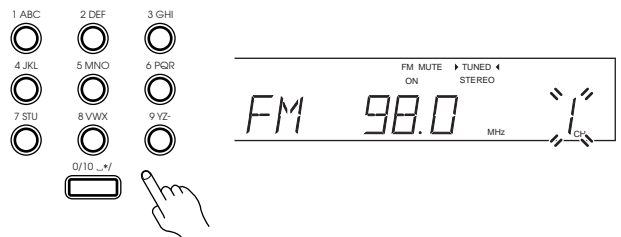

Press button 0/10 when choosing memory number 10.

E.g.:

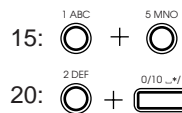

Receiving stations

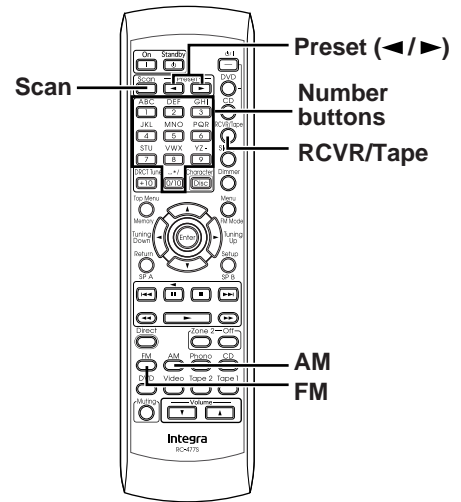
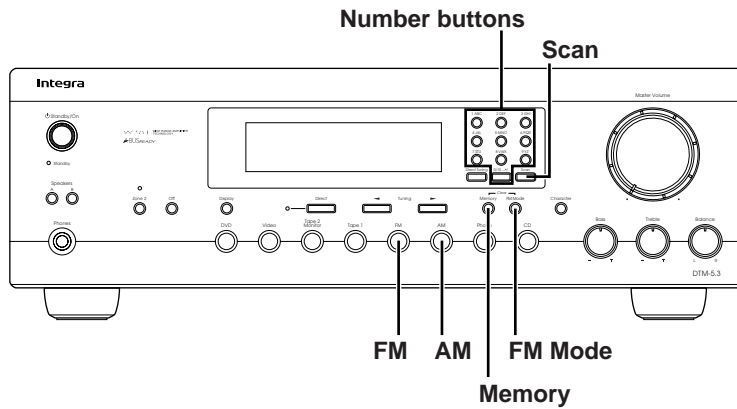

Selecting preset stations

First, select the tuner as the source by pressing the AM or FM input selector button.

Input the memory number you wish to receive by pressing the number buttons. For the remote controller, press the RCVR/Tape mode button before pressing the number buttons.

or

Press the Scan button.

When the desired station is located, press the Scan button again and scanning will stop.

or

Press the Preset ◀ or ▶ button on the remote controller.

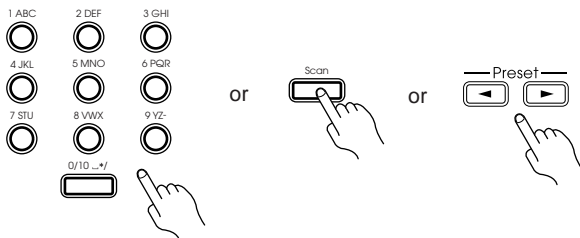

Cancelling preset stations

1 Select the station that you wish to cancel as explained in the previous section.



2 Press the FM Mode button while holding down the Memory button.

"--" will appear on the display.

Once the preset station has been cancelled, you can use the memory location to store another station.

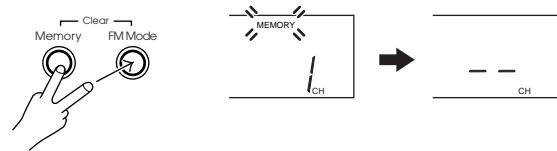

Entering station names

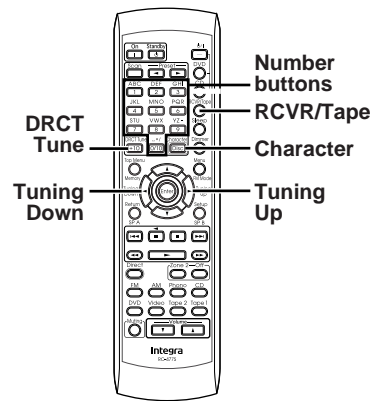
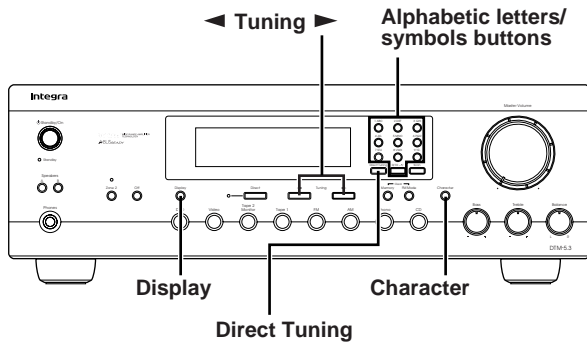

While receiving a preset FM or AM station, a maximum of eight characters consisting of letters, numbers and some symbols can be stored to represent the station name.

Characters which can be entered:
 A B C D E F G H I J K L M N O P Q R S T U V W X Y Z
 1 2 3 4 5 6 7 8 9 0 - _ * / Note: _ indicate a space.

Note: For the remote controller, press the RCVR/Tape mode button before performing the procedure in this section.

Entering characters

As an example, assume an FM station with a frequency of 89.5 MHz has been stored in preset number 2CH and will be given the name "ONKYO."

1 Select the desired station.

(Refer to "Selecting preset stations" on page 22.)



2 Press the Character button.

The frequency disappears from the display and the cursor () flashes.

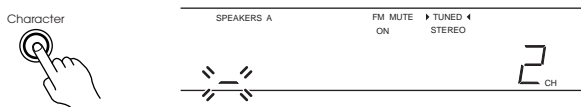

3 Continue pressing the 5MNO button until "O" is displayed.

With each press of the button, the character that appears in the display changes in the following sequence:

5 → M → N → O → 5 ...

If a button is not pressed within one second, the cursor automatically moves to the next position.

To delete a character, press the Direct Tuning button. After the selected character is deleted, all characters to the right of the deleted character move one space to the left.

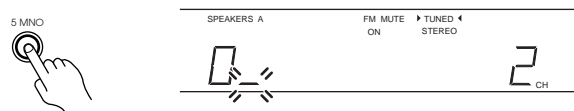

4 Continue pressing number buttons to enter the desired characters.

To enter N, press the 5MNO button.

To enter K, press the 4JKL button

To enter Y, press the 9YZ- button.



5 Press the Character button to store the entered characters.



If a button is not pressed within 16 seconds, the operation will end automatically.

- Press the Display button when you wish to check the frequency while you are entering the characters.

Changing an entered character

1 Select the desired station.

(Refer to "Selecting preset stations" on page 22.)

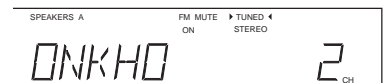

2 Press the Character button.

The first character and the cursor flash alternately.



3 Press the ◀Tuning▶ button (or Tuning Down and Up buttons on the remote controller) to move the cursor to the character that you wish to change.

The cursor moves to the right when the ▶ button is pressed and to the left when the ◀ button is pressed.



4 Enter the desired character.

The previous character is replaced with a new character.



5 Press the Character button.



Cleaning all characters

1 Select the desired station.

(Refer to "Selecting preset stations" on page 22.)

2 Press the Character button.

3 Hold down the Memory button and press the FM Mode button.

All characters entered for the selected station are cleared.

4 Press the Character button one more time.

Recording a source

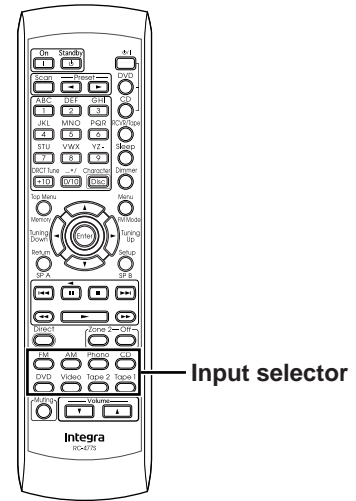
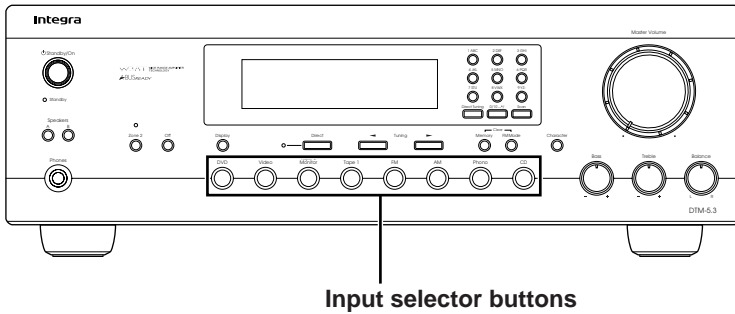

Recording an audio source

Please read the instruction manuals concerning operation of each unit.

- 1 Insert a blank tape into the tape deck.
- 2 Press the button (other than Tape 2 Monitor) for the source you wish to record.

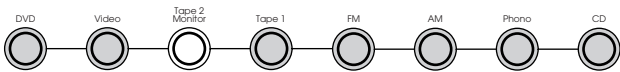

- When DVD or Video is selected, the audio portion of the program will be recorded.
- When FM or AM is selected, set the tuner to the station from which you wish to record.
- When TAPE 1 is selected, it will record to TAPE 2.
- When either DVD, Video, FM, AM, Phono or CD is selected, you will be able to record to both TAPE 1 and TAPE 2.

- 3 Put the tape deck in recording mode. Begin playing the source.

Set the proper recording level using the recording controls on the tape deck. During recording and dubbing operations, if any controls (bass, treble etc.) on the unit are changed, the tone will not change.

Note:

Recording from TAPE 2 to TAPE 1 is not possible.

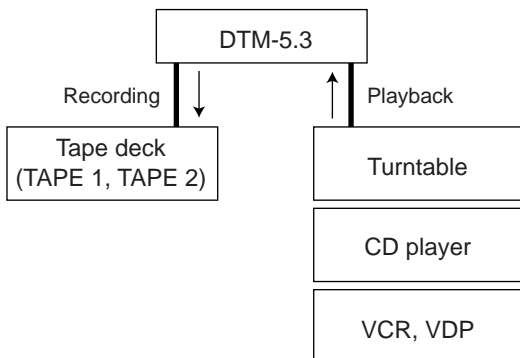

Tape-to-Tape dubbing

- 1 Load the original tape in the TAPE 1 tape deck and a blank tape in the TAPE 2 tape deck.
- 2 Press the Tape 1 button.



- 3 Place the TAPE 1 tape deck in playback mode and the TAPE 2 tape deck in recording mode.

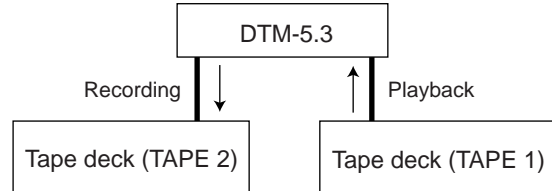

Recording a source

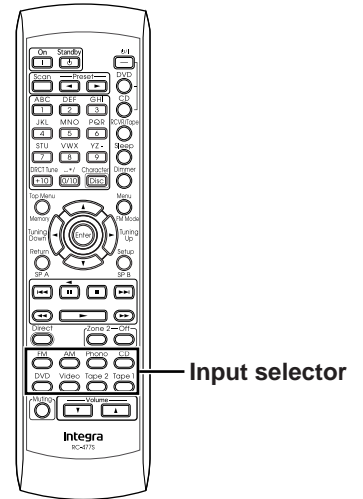
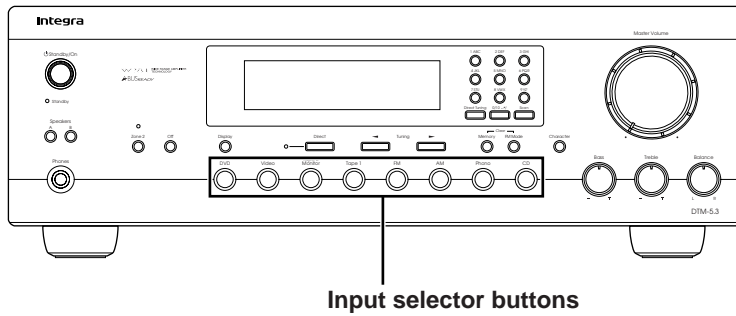

Video disc player (or video camcorder) to VCR recording

Video disc programs can be recorded onto a VCR (VIDEO).

- 1 Load a disc in the video disc player, and a blank tape in the VCR (VIDEO).
- 2 Press the DVD button.



- 3 Begin playback on the video disc player and begin recording on the VCR.

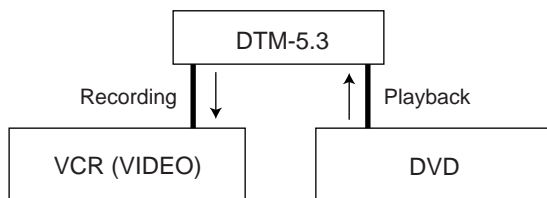

Adding new sound to a video tape during video editing

During video tape editing, you can add sound to the recording VCR from various audio program sources.

- 1 Insert the disc or tape from which you wish to record into the DVD or VCR connected to the DVD connector.
- 2 Insert a blank video tape in the VCR connected to the VIDEO connector.
- 3 Press the DVD button.



- 4 Select the audio program source (Tape 1, FM, AM, Phono, CD).

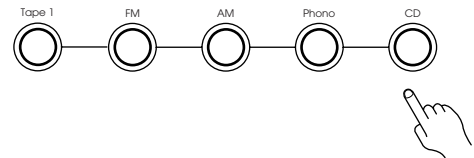

- 5 Begin playback of the video connected to the DVD connector. Start the sound source, then start recording on the VIDEO.

Refer to the video disc player, video camcorder or VCR instruction manuals for additional information.

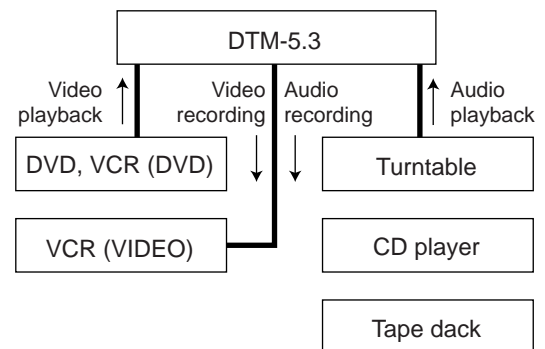

Using Tape 2 Monitor

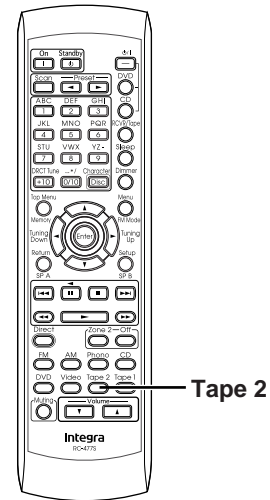
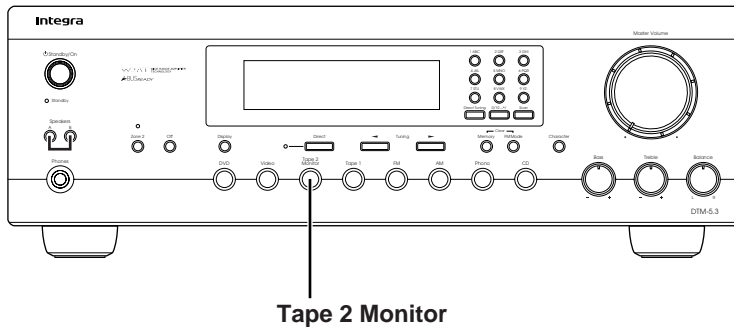

Unless the component connected to the TAPE 2 connectors is used, the **T-2 MONITOR** indicator in the main unit's display should not be lit; otherwise, the sound from other sources will not be heard.

If a 3-head tape deck is connected to the TAPE 2 connectors, you can use the Tape 2 Monitor to monitor the recording.

Notes:

- Even when Tape 2 is not selected as the source (the **T-2 MONITOR** indicator is not lit), the source signal is still sent to the TAPE 2 output.
- If you select a different input source while listening to the Tape 2 Monitor sound, the **T-2 MONITOR** indicator flashes for a few seconds. However, the audio signal does not change.

DTM-5.3

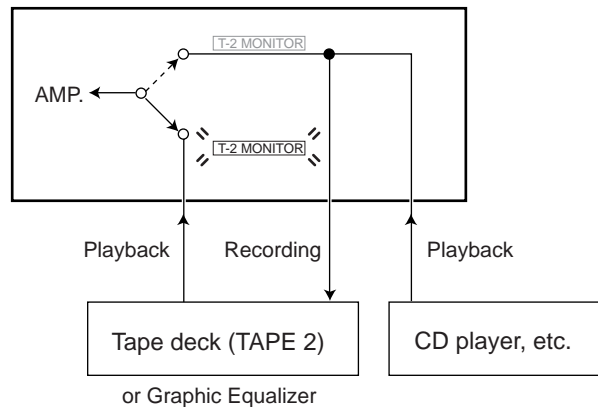

Monitoring during recording

You can monitor the source signal through the speakers or headphones when Tape 2 Monitor is turned off.

If the **T-2 MONITOR** indicator in the display is not lit, the sound from the source should be audible. If a 3-head tape deck connected to the TAPE 2 connectors is used for recording, press either the Tape 2 button on the remote controller or the Tape 2 Monitor button on the main unit. "TAPE 2" will appear in the display for a few seconds: the **T-2 MONITOR** indicator will light up and the sound you just recorded will be audible.

To return to listening to the source sound, press either the Tape 2 button on the remote controller or the Tape 2 Monitor button on the main unit. The **T-2 MONITOR** indicator turns off.

Using a graphic equalizer

- 1 Connect the graphic equalizer to the TAPE 2 connectors on the rear panel of the DTM-5.3.
- 2 If a second tape deck is used, connect it to the tape deck connectors on the graphic equalizer.
- 3 Press the Tape 2 button on the remote controller or the Tape 2 Monitor button on the main unit.

The **T-2 MONITOR** indicator on the main unit's display lights up.

- 4 Follow the operating instructions for the graphic equalizer. To record an equalized signal, use the tape deck connected to the equalizer.

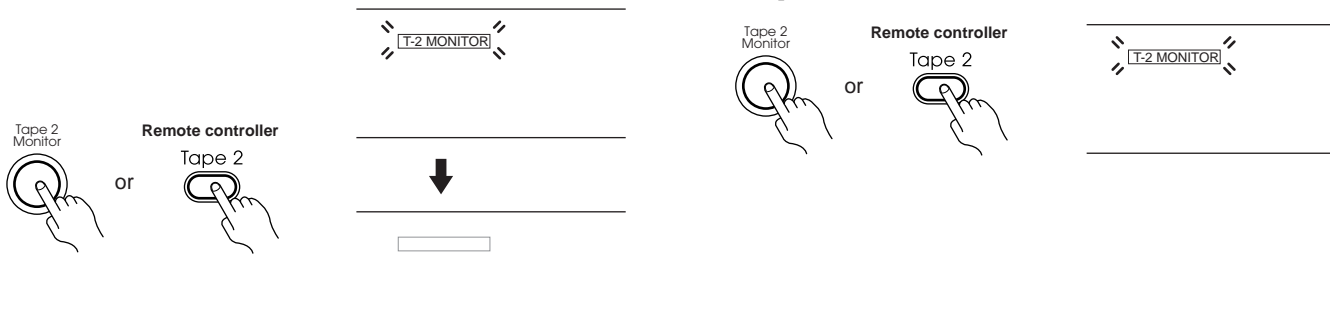

Enjoying music in the remote zone

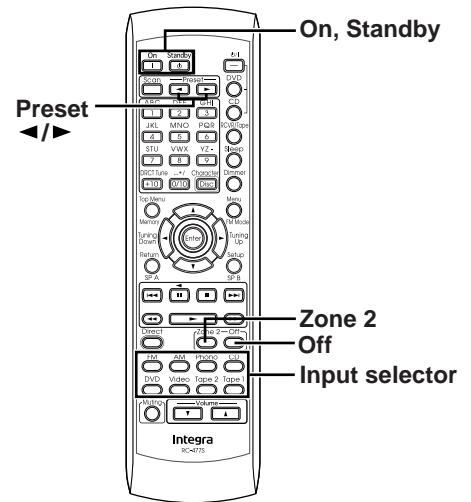
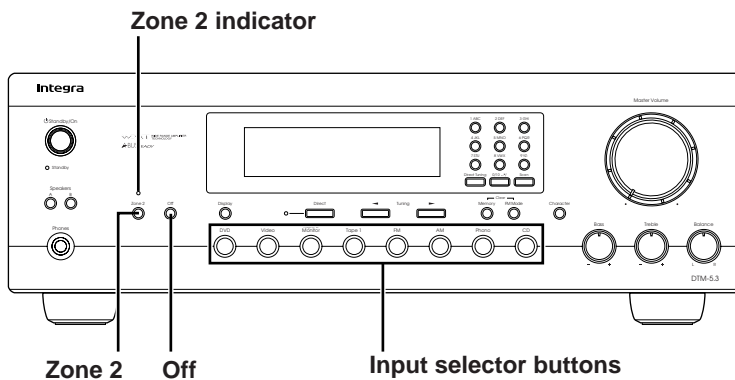

Zone 2 operation from the main room

To select a source for the zone 2 room other than the source selected for the main room.

- 1 Press the Zone 2 button, the Zone 2 indicator flashes.
- 2 Select an input source within five seconds.

The Zone 2 indicator will light up.

Example: When the CD button is pressed.

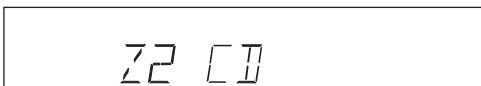

If you want to change the source for the zone 2 room to the same source that is selected for the main room, press the Zone 2 button again until "Z2 SRC" appears in the display.

To select the same source as that of the main room to zone 2 room.

- 1 Press the Zone 2 button twice while the Zone 2 indicator is flashing (within 5 seconds).

The Zone 2 indicator will light up continuously.



Notes:

- If you set a sleep time using the Sleep button, it will also function for the zone 2 room.
- If the source for the main room is selected as the source for the zone 2 room, and the source for the main room is changed, then the source for the zone 2 room will change as well.
- If you select FM (or AM) using the input source buttons when the source for the zone 2 room is set to AM (or FM), the output for the zone 2 room also changes to AM (or FM).
- When you are using the zone 2 room, the **RI** system will not function.
- If you are not using the Zone 2 function, press the Off button to turn off the Zone 2 indicator.
- Even if the main room device is in Standby mode, you can adjust the zone 2 room device settings. In this case, the display turns off and the Zone 2 indicator flashes.

Zone 2 (A-BUS or IR) operation in the zone 2 room

- 1 Press the On button on the remote controller.
The power to the Zone 2 devices turned on.

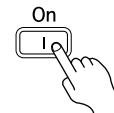

- 2 Select an input source.

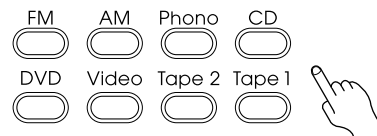

Notes:

- If you select FM or AM, use the Preset ◀▶ buttons to select a preset channel.
- Pressing the Standby button will place the Zone 2 device in Standby mode.

Using the remote controller

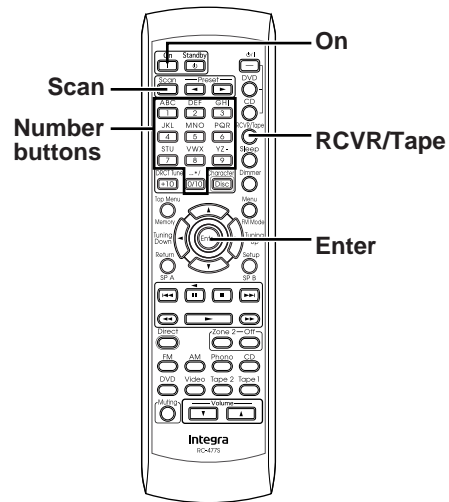
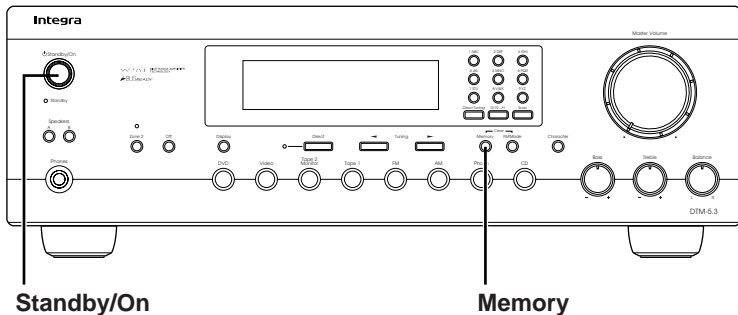

Setting the ID number

Programming the remote controller ID (This procedure is not required if you are using only one DTM-5.3.)

If you are using multiple DTM-5.3 units, all units will respond to an operation on one of the remote controllers. To avoid this, you can establish up to nine ID numbers for the remote controllers.

The same ID number should be set on both the remote controller and the corresponding DTM-5.3. You can use the remote controller as long as its ID matches that specified on the main unit.

To cancel the ID number, set the number to "0." If the ID on the main unit is set to "0," all remote controllers (with ID 0-9) can control the unit.

Programming the ID number

- 1 On the remote controller, while pressing and holding down the RCVR/Tape button, press the Enter button, then release both buttons.

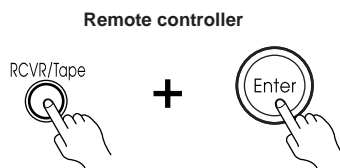

- 2 Press one of the number buttons (1–9, 0). The number you pressed is set as the ID.

Remote controller

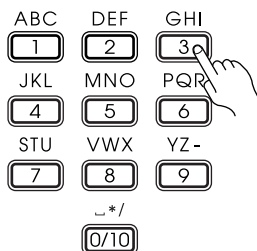

E.g.,
Press "3."

- 3 Turn on the power to the DTM-5.3, and press and hold down the Memory button.

The current ID number of the main unit appears on the display for five seconds.

DTM-5.3 (this unit)

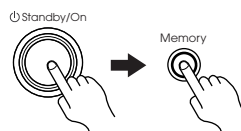

- 4 While the current ID of the unit appears on the display, press the On button on the remote controller.

The remote controller will send its ID information to the unit, and the ID of the unit will be changed to match the remote controller's ID.

Remote controller

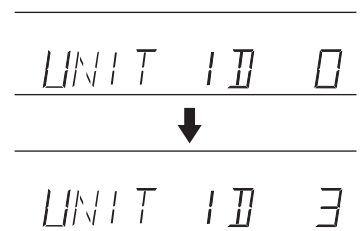
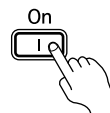

For example, if you press "3" in Step 2:

"UNIT ID 0" → "UNIT ID 3"

The unit's ID will change to "3."

Hint:

You can use the number buttons on the main unit instead of pressing the On button on the remote controller. In this case, press the same number as the remote controller's ID (selected in Step 2).

Checking the remote controller's ID:

Press the Scan button on the remote controller while the display indication shown in Step 4 appears. The remote controller's ID appears on the display.

E.g., REMOTE ID 3

Note:

The unit will not respond to remote controller operations if the ID numbers do not match.

Controlling other components

You can operate an **RI**-connected Integra/Onkyo CD player, cassette tape deck or DVD player using the remote controller provided with the DTM-5.3.

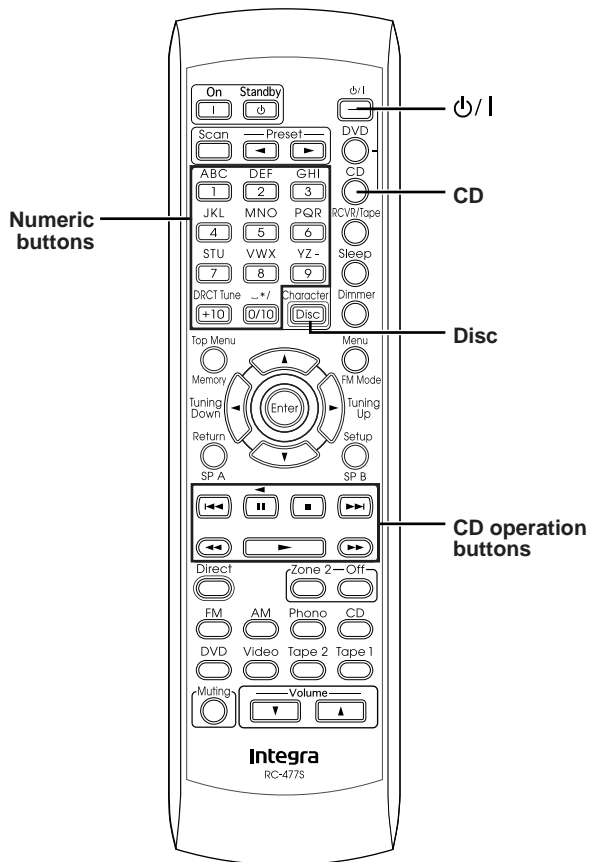

Controlling an Integra/Onkyo CD player

The **RI** connector of the Integra/Onkyo compact disc player must be connected to the DTM-5.3.

- 1 Press the **CD** button.
- 2 Press the **⏻/⏪** button to turn on the Integra/Onkyo compact disc player.
- 3 Press the desired operation button.

- ▶ : Starts playback of CD.
 - : Stops playback, fast forward or fast reverse.
 - ▶▶ : Fast forwards the CD.
 - ◀◀ : Fast reverses the CD.
 - || : Pauses playback temporarily.
 - ▶▶▶ : Skips to the beginning of the next track.
 - ◀◀◀ : Skips to the beginning of the current or previous track.
- DISC : This button is valid when a CD changer is used. It selects the disc to be played.
- 1 to 9, +10, 0/10 : Numeric keys

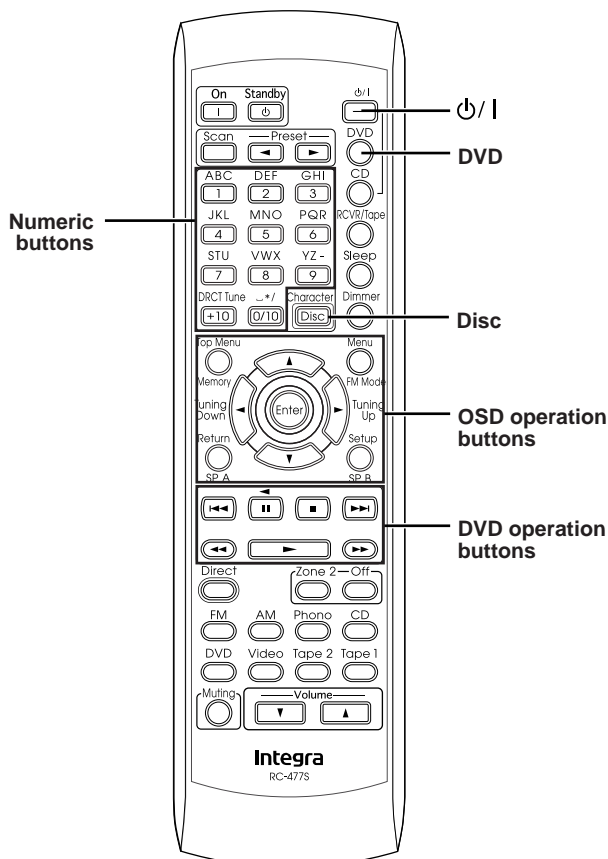

Controlling an Integra/Onkyo DVD player

The **RI** connector of the Integra/Onkyo DVD player must be connected to the DTM-5.3.

- 1 Press the **DVD** button.
- 2 Press the **⏻/⏪** button to turn on the Integra/Onkyo DVD player.
- 3 Press the desired operation button.

- DVD operation buttons**
- ▶ : Starts playback of DVD.
 - : Stops playback, fast forward or reverse.
 - ▶▶ : Searches the disc in the forward direction.
 - ◀◀ : Searches the disc in the reverse direction.
 - || : Pauses playback temporarily or advances the disc frame-by-frame.
 - ▶▶▶ : Starts playback from the beginning of the next chapter/track.
 - ◀◀◀ : Starts playback from the beginning of the current chapter/track.
- DISC : This button is valid when a DVD changer is used. It selects the disc to be played.

- OSD operation buttons**
- Top Menu : Displays the top menu of each DVD disc.
 - Menu : Displays a menu recorded in the DVD disc.
 - Return : Returns to the previous menu.
 - Setup : Displays the setup menu.
 - ◀/▶/▲/▼ : Selects an item in a menu.
 - Enter : Enters the selection in memory.
 - 1 to 9, +10, 0/10 : Numeric keys

Controlling other components

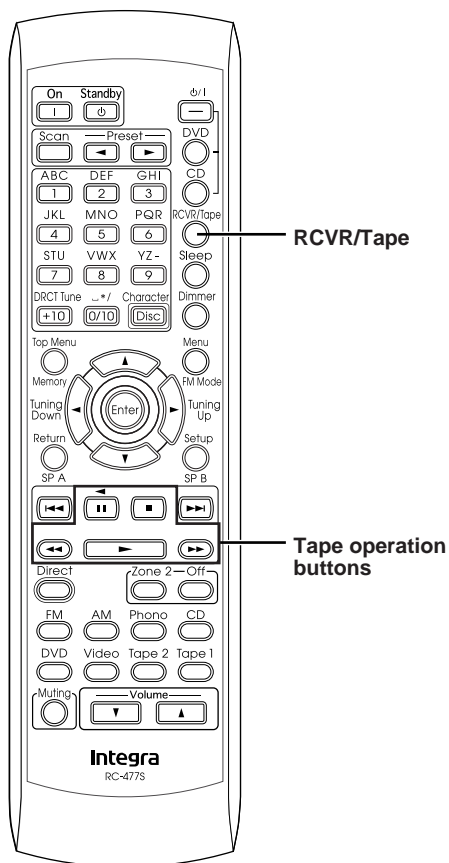

Controlling an Integra/Onkyo cassette tape deck

The **RI** connector of the Integra/Onkyo cassette tape deck must be connected to the DTM-5.3.

1 Press the RCVR/Tape button.

2 Press the desired operation button.

- ▶ : Plays side A (the side facing the front) of the tape.
- : Stops playback, recording, fast forward or rewinding.
- ▶▶ : Fast forwards the tape.
- ◀◀ : Rewinds the tape.
- ◀ : Plays side B (the side facing the rear) of the tape.

Troubleshooting guide

If a problem occurs, while you are using the remote controller, first operate the unit using the front panel controls to confirm that it is not due to a malfunction (or expired batteries) of the remote controller.

Trouble	Cause	Remedy
No power.	<ul style="list-style-type: none"> Power cord is disconnected. There is external noise in the computer circuits of this unit. 	<ul style="list-style-type: none"> Connect power cord. Turn the power switch off and then on again, or remove the AC plug from the outlet and then plug it again.
Power but no sound.	<ul style="list-style-type: none"> T-2 MONITOR indicator is flashed. AUDIO MUTE indicator is lit. Bad/incorrect connections. 	<ul style="list-style-type: none"> Turn the Tape 2 Monitor off. Muting off with the remote controller. Check connection cables, speaker cables, etc.
Hum, low-frequency noise.	<ul style="list-style-type: none"> Poor or no input ground. Poor or no phono motor ground. The placement of the audio connection cables on the rear panel is incorrect. 	<ul style="list-style-type: none"> Check outer conductor of input plugs. Check for proper ground connection. Adjust the placement of the cable to reduce hum.
Howling when the volume is turned up.	<ul style="list-style-type: none"> Turntable and speakers are too close together. 	<ul style="list-style-type: none"> Move them farther apart.
Rough or scratchy sound; high frequency range is not clear.	<ul style="list-style-type: none"> Stylus of turntable pick-up is worn. Turntable stylus tip is dirty. Treble control is too high. 	<ul style="list-style-type: none"> Replace. Clean. Turn treble control down.
AM stations cannot be received.	<ul style="list-style-type: none"> AM loop antenna is not attached. 	<ul style="list-style-type: none"> Connect the included AM loop antenna to the AM antenna terminals.
Buzzing noise on AM (particularly conspicuous at night or with weak stations).	<ul style="list-style-type: none"> Noise from electrical apparatus such as a fluorescent lamp. 	<ul style="list-style-type: none"> Move the AM loop antenna as far as possible from the TV. Move unit away from TV set.
High-pitched noise or buzzing noise on AM.	<ul style="list-style-type: none"> Noise from TV set. 	<ul style="list-style-type: none"> Place the AM loop antenna as far as possible from the TV. Move unit away from TV set.
Crackling noise on AM or FM.	<ul style="list-style-type: none"> Noise caused by turning fluorescent lamp on and off. Noise from automobile ignition. 	<ul style="list-style-type: none"> Move antenna as far as possible from the fluorescent lamp. Install an FM outdoor antenna as far as possible from the automobile. Change the position or direction of the outdoor antenna.
▶TUNED◀ and STEREO indicators light but sound is distorted and stereo separation is bad.	<ul style="list-style-type: none"> Station is too strong. Multiple reflection of radio waves because of tall buildings or mountains. 	<ul style="list-style-type: none"> Change to a FM indoor antenna. Use an antenna that has better directivity and select a point at which the distortion is least.
▶TUNED◀ and STEREO indicators flicker, and hiss is heard on FM.	<ul style="list-style-type: none"> Station is too weak. Stereo FM broadcasts cover only about half the distance of an ordinary broadcast. 	<ul style="list-style-type: none"> Install an outdoor FM antenna. Change the position or direction of the outdoor antenna.
No station is recalled when a Preset or Scan button is pressed.	<ul style="list-style-type: none"> The power cord has been unplugged for a long time. 	<ul style="list-style-type: none"> The memory contents are lost. Store all stations again.
Front panel controls function, but remote controller does not.	<ul style="list-style-type: none"> No batteries in remote controller. Batteries have worn out. 	<ul style="list-style-type: none"> Insert batteries. Replace batteries.

- Also refer to the respective instruction manuals for the video disc player, video cassette recorder, TV monitor, etc.

Specifications

AMPLIFIER SECTION

Power Output:	100 Watts per channel, min RMS, at 8 ohms, both channels driven from 20 Hz to 20 kHz, with no more than 0.08% THD.
Dynamic power output:	2 × 170 Watts at 2 ohms 2 × 135 Watts at 4 ohms 2 × 140 Watts at 8 ohms
Total Harmonic Distortion:	0.08% at rated power 0.08% at 1 watt output
IM Distortion:	0.08% at rated power 0.08% at 1 watt output
Damping Factor:	60 at 8 ohms
Input Sensitivity and Impedance	
PHONO:	2.5 mV, 50 kohms
Line (CD, TAPE-1, 2, VIDEO, DVD):	150 mV, 50 kohms
Video (VIDEO, DVD)	1 Vp-p, 75 ohms
Output Level and Impedance	
Line (TAPE-1, 2, VIDEO):	150 mV, 2.2 kohms
Video (VIDEO, MONITOR):	1 Vp-p, 75 ohms
Zone 2:	150 mV, 22 kohms
Phono Overload:	120 mV RMS. at 1 kHz, 0.5% T.H.D.
Frequency Response:	20 Hz to 30 kHz : ±1 dB
RIAA Deviation:	20 Hz to 20 kHz : ±0.8 dB
Tone Control	
Bass:	±10 dB at 100 Hz
Treble:	±10 dB at 10,000 Hz
Signal-to-Noise Ratio	
Phono:	80 dB (IHF A, 5 mV input)
CD/Tape:	100 dB (IHF A)
Muting:	-50 dB

TUNER SECTION

FM

Tuning Range:	87.5 to 108.0 MHz (100 kHz steps)
Usable Sensitivity	
Mono:	11.2 dBf, 1.0 μV (75 ohms IHF) 0.9 μV (75 ohms DIN)
Stereo:	17.2 dBf, 2.0 μV (75 ohms IHF) 23 μV (75 ohms DIN)
50 dB Quieting Sensitivity	
Mono:	17.2 dBf, 2.0 μV (75 ohms)
Stereo:	37.2 dBf, 20 μV (75 ohms)
Capture Ratio:	2.0 dB

Image Rejection Ratio:	40 dB
IF Rejection Ratio:	90 dB
Signal-to-Noise Ratio	
Mono:	76 dB, IHF
Stereo:	70 dB, IHF
Alternate Channel Att. (±400 kHz)	
Mono:	55 dB, IHF
Selectivity:	55 dB DIN (±300 kHz 40 kHz Devi.)
AM Suppression Ratio:	50 dB
Total Harmonic Distortion	
Mono:	0.15%
Stereo:	0.25%
Frequency Response:	30 Hz to 15 kHz, ±1.5 dB
Stereo Separation:	45 dB at 1 kHz 30 dB at 100 Hz to 10 kHz
Stereo Threshold:	17.2 dBf, 2.0 μV (75 ohms)

AM

Tuning Range:	530 to 1,710 kHz (10 kHz steps)
Usable Sensitivity:	30 μV
Image Rejection Ratio:	40 dB
IF Rejection Ratio:	40 dB
Signal-to-Noise Ratio:	40 dB
Total Harmonic Distortion:	0.7%

GENERAL

Power Supply:	AC 120 V, 60 Hz
Power Consumption:	2.8 A
Dimensions (W × H × D):	17-1/8" × 5-7/8" × 13-7/16" 435 × 150 × 341 mm
Weight:	19.8 lbs. (9.0 kg)

REMOTE CONTROLLER (RC-477S)

Transmitter:	Infrared
Signal range:	Approx. 16 ft., 5 meters
Power supply:	Two "AA" batteries (1.5 V × 2)

Specifications and features are subject to change without notice.

Integra Division of
ONKYO U.S.A. CORPORATION
18 park Way, Upper Saddle River, N.J. 07458, U.S.A.
Tel: 201-785-2600 Fax: 201-785-2650 <http://www.integrahometheater.com>

Integra Division of
ONKYO CORPORATION
Sales & Product Planning Div. : 2-1, Nisshin-cho, Neyagawa-shi, OSAKA 572-8540, JAPAN
Tel: 072-831-8111 Fax: 072-833-5222



Free Manuals Download Website

<http://myh66.com>

<http://usermanuals.us>

<http://www.somanuals.com>

<http://www.4manuals.cc>

<http://www.manual-lib.com>

<http://www.404manual.com>

<http://www.luxmanual.com>

<http://aubethermostatmanual.com>

Golf course search by state

<http://golfingnear.com>

Email search by domain

<http://emailbydomain.com>

Auto manuals search

<http://auto.somanuals.com>

TV manuals search

<http://tv.somanuals.com>