

AV Receiver

# DTR-4.6

Instruction Manual

**Integra**

**WARNING:**

TO REDUCE THE RISK OF FIRE OR ELECTRIC SHOCK, DO NOT EXPOSE THIS APPARATUS TO RAIN OR MOISTURE.

**CAUTION:**

TO REDUCE THE RISK OF ELECTRIC SHOCK, DO NOT REMOVE COVER (OR BACK). NO USER-SERVICEABLE PARTS INSIDE. REFER SERVICING TO QUALIFIED SERVICE PERSONNEL.



**WARNING**  
RISK OF ELECTRIC SHOCK  
DO NOT OPEN

**AVIS**  
RISQUE DE CHOC ELECTRIQUE  
NE PAS OUVRIR



The lightning flash with arrowhead symbol, within an equilateral triangle, is intended to alert the user to the presence of uninsulated "dangerous voltage" within the product's enclosure that may be of sufficient magnitude to constitute a risk of electric shock to persons.



The exclamation point within an equilateral triangle is intended to alert the user to the presence of important operating and maintenance (servicing) instructions in the literature accompanying the appliance.



## Important Safety Instructions

1. Read these instructions.
2. Keep these instructions.
3. Heed all warnings.
4. Follow all instructions.
5. Do not use this apparatus near water.
6. Clean only with dry cloth.
7. Do not block any ventilation openings. Install in accordance with the manufacturer's instructions.
8. Do not install near any heat sources such as radiators, heat registers, stoves, or other apparatus (including amplifiers) that produce heat.
9. Do not defeat the safety purpose of the polarized or grounding-type plug. A polarized plug has two blades with one wider than the other. A grounding type plug has two blades and a third grounding prong. The wide blade or the third prong are provided for your safety. If the provided plug does not fit into your outlet, consult an electrician for replacement of the obsolete outlet.
10. Protect the power cord from being walked on or pinched particularly at plugs, convenience receptacles, and the point where they exit from the apparatus.
11. Only use attachments/accessories specified by the manufacturer.
12. Use only with the cart, stand, tripod, bracket, or table specified by the manufacturer, or sold with the apparatus. When a cart is used, use caution when moving the cart/apparatus combination to avoid injury from tip-over.
 

PORTABLE CART WARNING

13. Unplug this apparatus during lightning storms or when unused for long periods of time.
14. Refer all servicing to qualified service personnel. Servicing is required when the apparatus has been damaged in any way, such as power-supply cord or plug is damaged, liquid has been spilled or objects have fallen into the apparatus, the apparatus has been exposed to rain or moisture, does not operate normally, or has been dropped.
15. Damage Requiring Service
 

Unplug the apparatus from the wall outlet and refer servicing to qualified service personnel under the following conditions:

  - A. When the power-supply cord or plug is damaged,
  - B. If liquid has been spilled, or objects have fallen into the apparatus,
  - C. If the apparatus has been exposed to rain or water,
  - D. If the apparatus does not operate normally by following the operating instructions. Adjust only those controls that are covered by the operating instructions as an improper adjustment of other controls may result in damage and will often require extensive work by a qualified technician to restore the apparatus to its normal operation,
  - E. If the apparatus has been dropped or damaged in any way, and
  - F. When the apparatus exhibits a distinct change in performance this indicates a need for service.
16. Object and Liquid Entry
 

Never push objects of any kind into the apparatus through openings as they may touch dangerous voltage points or short-out parts that could result in a fire or electric shock.

The apparatus shall not be exposed to dripping or splashing and no objects filled with liquids, such as vases shall be placed on the apparatus.

Don't put candles or other burning objects on top of this unit.
17. Batteries
 

Always consider the environmental issues and follow local regulations when disposing of batteries.
18. If you install the apparatus in a built-in installation, such as a bookcase or rack, ensure that there is adequate ventilation.
 

Leave 20 cm (8") of free space at the top and sides and 10 cm (4") at the rear. The rear edge of the shelf or board above the apparatus shall be set 10 cm (4") away from the rear panel or wall, creating a flue-like gap for warm air to escape.

# Precautions

1. **Recording Copyright**—Unless it's for personal use only, recording copyrighted material is illegal without the permission of the copyright holder.
2. **AC Fuse**—The AC fuse inside the unit is not user-serviceable. If you cannot turn on the unit, contact the dealer from whom you purchased this unit.
3. **Care**—Occasionally you should dust the unit all over with a soft cloth. For stubborn stains, use a soft cloth dampened with a weak solution of mild detergent and water. Dry the unit immediately afterwards with a clean cloth. Don't use abrasive cloths, thinners, alcohol, or other chemical solvents, because they may damage the finish or remove the panel lettering.
4. **Power**  
**WARNING**  
**BEFORE PLUGGING IN THE UNIT FOR THE FIRST TIME, READ THE FOLLOWING SECTION CAREFULLY.**  
 AC outlet voltages vary from country to country. Make sure that the voltage in your area meets the voltage requirements printed on the unit's rear panel (e.g., AC 230 V, 50 Hz or AC 120 V, 60 Hz).  
 Setting the [Standby/On] switch to Standby does not fully shutdown the unit. If you do not intend to use the unit for an extended period, remove the power cord from the AC outlet.
5. **Never Touch this Unit with Wet Hands**—Never handle this unit or its power cord while your hands are wet or damp. If water or any other liquid gets inside this unit, have it checked by the dealer from whom you purchased this unit.
6. **Handling Notes**
  - If you need to transport this unit, use the original packaging to pack it how it was when you originally bought it.
  - Do not leave rubber or plastic items on this unit for a long time, because they may leave marks on the case.
  - This unit's top and rear panels may get warm after prolonged use. This is normal.
  - If you do not use this unit for a long time, it may not work properly the next time you turn it on, so be sure to use it occasionally.

## Memory Backup

The AV receiver uses a battery-less memory backup system in order to retain radio presets and other settings when it's unplugged or in the case of a power failure. Although no batteries are required, the AV receiver must be plugged into an AC outlet in order to charge the backup system. Once it has been charged, the AV receiver will retain the settings for several weeks, although this depends on the environment and will be shorter in humid climates.

## For U.S. models

### FCC Information for User

#### CAUTION:

The user changes or modifications not expressly approved by the party responsible for compliance could void the user's authority to operate the equipment.

#### NOTE:

This equipment has been tested and found to comply with the limits for a Class B digital device, pursuant to Part 15 of the FCC Rules. These limits are designed to provide reasonable protection against harmful interference in a residential installation.

This equipment generates, uses and can radiate radio frequency energy and, if not installed and used in accordance with the instructions, may cause harmful interference to radio communications. However, there is no guarantee that interference will not occur in a particular installation. If this equipment does cause harmful interference to radio or television reception, which can be determined by turning the equipment off and on, the user is encouraged to try to correct the interference by one or more of the following measures:

- Reorient or relocate the receiving antenna.
- Increase the separation between the equipment and receiver.
- Connect the equipment into an outlet on a circuit different from that to which the receiver is connected.
- Consult the dealer or an experienced radio/TV technician for help.

## For Canadian Models

**NOTE:** THIS CLASS B DIGITAL APPARATUS COMPLIES WITH CANADIAN ICES-003.

For models having a power cord with a polarized plug:

**CAUTION:** TO PREVENT ELECTRIC SHOCK, MATCH WIDE BLADE OF PLUG TO WIDE SLOT, FULLY INSERT.

## Modèle canadien

**REMARQUE:** CET APPAREIL NUMÉRIQUE DE LA CLASSE B EST CONFORME À LA NORME NMB-003 DU CANADA.

Sur les modèles dont la fiche est polarisée:

**ATTENTION:** POUR ÉVITER LES CHOCS ÉLECTRIQUES, INTRODUIRE LA LAME LA PLUS LARGE DE LA FICHE DANS LA BORNE CORRESPONDANTE DE LA PRISE ET POUSSER JUSQU'AU FOND.

Thank you for purchasing an Integra AV Receiver. Please read this manual thoroughly before making connections and plugging in the unit. Following the instructions in this manual will enable you to obtain optimum performance and listening enjoyment from your new AV Receiver. Please retain this manual for future reference.

## Supplied Accessories

Make sure you have the following accessories:

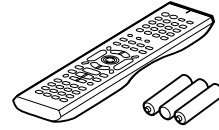

**Remote controller and three batteries (AA/R6)**

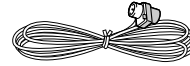

**Indoor FM antenna**

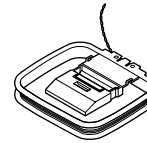

**AM loop antenna**

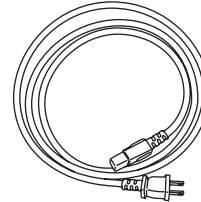

**Power cord**  
(Plug type varies from country to country.)

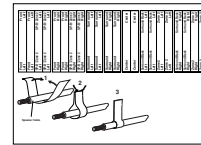

**Speaker cable labels**

\* In catalogs and on packaging, the letter at the end of the product name indicates the color. Specifications and operation are the same regardless of color.

# Contents

Introduction	
<b>Important Safety Instructions .....</b>	<b>2</b>
<b>Precautions .....</b>	<b>3</b>
<b>Supplied Accessories.....</b>	<b>4</b>
<b>Features .....</b>	<b>6</b>
<b>Before Using the AV receiver .....</b>	<b>7</b>
<b>Getting to Know the AV Receiver .....</b>	<b>8</b>
<b>Remote Controller.....</b>	<b>12</b>

Connection	
<b>Connecting Your Speakers .....</b>	<b>17</b>
<b>Connecting Antenna.....</b>	<b>20</b>
<b>Connecting Your Components .....</b>	<b>22</b>
About AV Connections .....	22
Connecting Audio and Video Signals to the AV Receiver .....	23
Which Connections Should I Use? .....	23
TV or Projector .....	24
DVD player .....	25
VCR or DVD Recorder for Playback .....	27
VCR or DVD Recorder for Recording.....	28
Satellite, Cable, Set-top box, or Other Video Source .....	29
CD Player .....	30
Turntable .....	31
Cassette, CDR, MiniDisc, or DAT Recorder .....	32
Connecting <b>RI</b> Components.....	33
Connecting the Power Cords of Other Components.....	34
Connecting the RS232 Port.....	34
Connecting the Power Cord .....	34

Turning On & First Time Setup	
<b>Turning On the AV Receiver .....</b>	<b>35</b>
Turning On and Standby .....	35
<b>First Time Setup .....</b>	<b>36</b>
Speaker Setup.....	36
Component Video Setup .....	39
Digital Audio Input Setup.....	40
Changing the Input Display .....	41

Basic Operation	
<b>Playing Your AV Components .....</b>	<b>42</b>
<b>Listening to the Radio.....</b>	<b>43</b>
Listening to AM/FM Stations.....	43
Listening to XM Satellite Radio®.....	44
Presetting AM/FM Stations and XM Channels.....	48
<b>Using the Multichannel DVD Input.....</b>	<b>49</b>
<b>Common Functions.....</b>	<b>50</b>
Setting the Display Brightness.....	50
Adjusting Speaker Levels .....	50
Muting the AV Receiver .....	50
Using the Sleep Timer .....	51
Using Headphones .....	51
Displaying Source Information.....	51

Enjoying the Listening Modes	
<b>Using the Listening Modes.....</b>	<b>52</b>
Selecting the Listening Modes.....	52
About the Listening Modes .....	54

Advanced Operation	
<b>Recording.....</b>	<b>55</b>
<b>Onscreen Setup Menus .....</b>	<b>56</b>
<b>Adjusting the Listening Modes .....</b>	<b>57</b>
Using the Cine Filter Function .....	57
Audio Adjust Menu .....	57
Default Listening Modes .....	60
<b>Advanced Setup .....</b>	<b>61</b>
Input Setup .....	61
Preferences .....	62
Remote IDs.....	64
Digital Input Signal Formats .....	65
<b>Zone 2.....</b>	<b>66</b>
Connecting Zone 2 .....	66
Powered Zone 2 Setting.....	67
Zone 2 Out Setting .....	67
Using Zone 2 .....	68
Using the 12V Triggers in Zone 2 and Main Room .....	70
Using the Remote Controller in Zone 2 and Multiroom Control Kits .....	71
<b>Controlling Other Components.....</b>	<b>72</b>
Entering Remote Control Codes.....	72
Resetting the Remote Controller .....	73
Learning Commands from Other Remote Controllers .....	75
Using Macros.....	76

<b>Troubleshooting .....</b>	<b>77</b>
<b>Specification .....</b>	<b>80</b>

# Features

## Amplifier

- 90 watts per channel into 8 ohms, 20 Hz to 20 kHz, less than 0.08% total harmonic distortion (FTC rating)
- 5-channel amplifier
- Optimum Gain Volume Circuitry
- WRAT (Wide Range Amplifier Technology)
- Massive High Current Power Supply (H.C.P.S.) transformer
- Color-coded speaker terminal posts

## Processing

- Dolby<sup>\*1</sup> Digital, Dolby Pro Logic II
- DTS<sup>\*2</sup>, DTS Neo:6, and DTS 96/24
- 24-bit/192 kHz D/A converters
- Powerful and highly accurate 32-bit DSP processing.
- Cine Filter Function

## Audio/Video

- Composite video to S-Video and S-Video to composite video conversion
- 5 digital inputs (3 optical, 2 coaxial), 1 output (optical)
- 3 component video inputs, 1 output
- 5 S-Video inputs, 3 outputs
- RS-232 control
- Color-coded 5.1 multichannel input
- Subwoofer pre out

## Tuner

- XM<sup>\*3</sup> Satellite Radio
- \*XM Connect-and-Play accessory required; sold separately.
- 40 AM/FM/XM presets
- AM/FM auto tuning

## Others

- Easy-to-use onscreen setup menus
- Preprogrammed remote controller for use with other AV components
- Remote controller Learning function
- Remote controller Macro function
- Powered Zone 2
- 3 12 V trigger outputs (A/B/C)
- 2 IR inputs (A/B), 1 output

- \*1 Manufactured under license from Dolby Laboratories. "Dolby", "Pro Logic", and the double-D symbol are trademarks of Dolby Laboratories.
- \*2 "DTS", "DTS 96/24", and "Neo:6" are trademarks of Digital Theater Systems, Inc.
- \*3 XM Connect & Play<sup>™</sup>, XM Ready<sup>®</sup>, XM Public Radio<sup>™</sup> are trademarks of XM Satellite Radio Inc. ©2005 XM Satellite Radio Inc. All rights reserved. All other trademarks are the property of their respective owners.



- \* "Xantech" is a registered trademark of Xantech Corporation.
- \* "Niles" is a registered trademark of Niles Audio Corporation.
- \* Apple and iPod are trademarks of Apple Computer, Inc., registered in the U.S. and other countries.

This product incorporates copyright protection technology that is protected by U.S. patents and other intellectual property rights. Use of this copyright protection technology must be authorized by Macrovision Corporation, and is intended for home and other limited consumer uses only unless otherwise authorized by Macrovision. Reverse engineering or disassembly is prohibited.

# Before Using the AV receiver

## Installing the Batteries

- 1** To open the battery compartment, press the small hollow and slide open the cover.

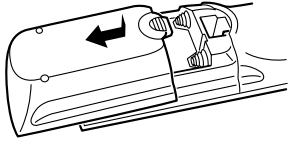

- 2** Insert the three supplied batteries (AA/R6) in accordance with the polarity diagram inside the battery compartment.

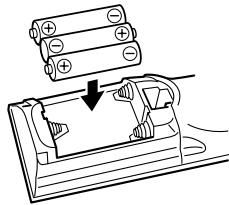

- 3** Slide the cover shut.

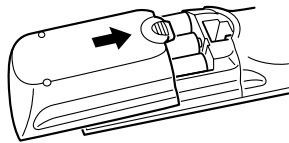

### Notes:

- If the remote controller doesn't work reliably, try replacing the batteries.
- Don't mix new and old batteries or different types of batteries.
- If you intend not to use the remote controller for a long time, remove the batteries to prevent damage from leakage or corrosion.
- Expired batteries should be removed as soon as possible to prevent damage from leakage or corrosion.

## Using the Remote Controller

To use the remote controller, point it at the AV receiver's remote control sensor, as shown below.

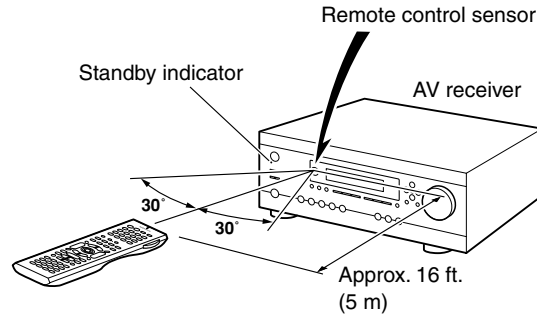

### Notes:

- The remote controller may not work reliably if the AV receiver is subjected to bright light, such as direct sunlight or inverter-type fluorescent lights. Keep this in mind when installing.
- If another remote controller of the same type is used in the same room, or the AV receiver is installed close to equipment that uses infrared rays, the remote controller may not work reliably.
- Don't put anything on top of the remote controller, such as a book or magazine, because a button may be pressed continuously, thereby draining the batteries.
- The remote controller may not work reliably if the AV receiver is installed in a rack behind colored glass doors. Keep this in mind when installing.
- The remote controller will not work if there's an obstacle between it and the AV receiver's remote control sensor.

# Getting to Know the AV Receiver

## Front Panel

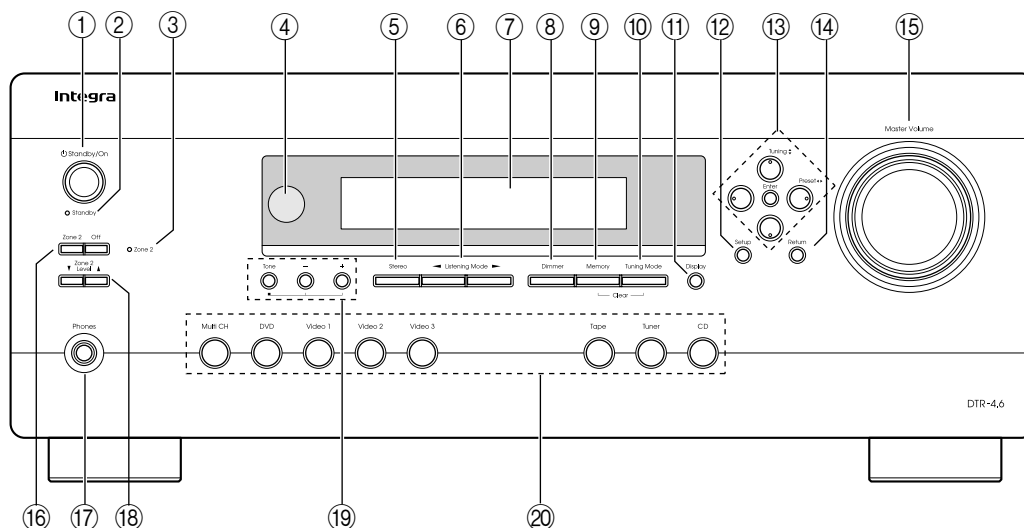

For detailed information, see the pages in parentheses.

- ① **Standby/On button (35)**  
Sets the AV receiver to On or Standby.
- ② **Standby indicator (35)**  
Lights up when the AV receiver is on Standby and flashes while a signal is being received from the remote controller.
- ③ **Zone 2 indicator (68)**  
Lights up when Zone 2 is on.
- ④ **Remote-control sensor (7)**  
Receives control signals from the remote controller.
- ⑤ **Stereo button (52)**  
Selects the Stereo listening mode.
- ⑥ **Listening Mode [◀]/[▶] buttons (52)**  
Select the listening modes.
- ⑦ **Display**  
See “Display” on page 9.
- ⑧ **Dimmer button (50)**  
Adjusts the display brightness.
- ⑨ **Memory button (48)**  
Used when storing or deleting radio presets.
- ⑩ **Tuning Mode button (43)**  
Selects the Auto or Manual tuning mode for AM and FM radio.
- ⑪ **Display button (51)**  
Displays various information about the currently selected input source.
- ⑫ **Setup button**  
Opens and closes the onscreen setup menus, which are displayed on the connected TV.
- ⑬ **Arrow/Tuning/Presets and Enter buttons**  
When AM, FM, or XM is selected, the Tuning [▲] [▼] buttons are used for radio tuning, and the Preset [◀] [▶] buttons are used to select radio presets (see page 48). With the onscreen setup menus, they work as arrow buttons and are used to select and set items. The Enter button is also used with the onscreen setup menus.
- ⑭ **Return button**  
Selects the previously displayed onscreen setup menu.
- ⑮ **Master Volume control (42)**  
Sets the volume of the AV receiver to  $-\infty$  dB,  $-81$  dB,  $-80$  dB through  $+18$  dB (relative display).  
The volume level can also be displayed as an absolute value. See “Volume Setup” on page 62.
- ⑯ **Zone 2 and Off buttons (68)**  
The Zone 2 button is used to turn on Zone 2 and select the input source for Zone 2.  
The Off button is used to turn off Zone 2.
- ⑰ **Phones jack (51)**  
This 1/4-inch phone jack is for connecting a standard pair of stereo headphones for private listening.
- ⑱ **Zone 2 Level [▲]/[▼] buttons (69)**  
Set the volume of the Zone 2 speakers.
- ⑲ **Tone, [-], and [+] buttons (58, 69)**  
Used to adjust the bass and treble.
- ⑳ **Input selector buttons (42)**  
Select the following input sources: Multi CH, DVD, Video 1, Video 2, Video 3, Tape, Tuner, or CD.  
The [Multi CH] button selects the multichannel DVD input.



## Getting to Know the AV Receiver—Continued

### Display

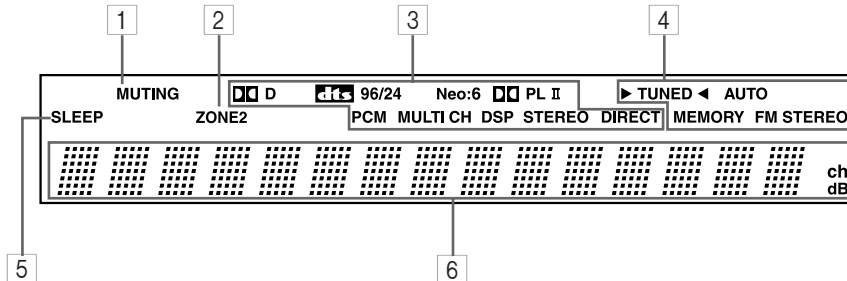

For detailed information, see the pages in parentheses.

- 1 **MUTING indicator (50)**  
Flashes while the AV receiver is muted.
- 2 **ZONE 2 indicator (68)**  
Lights up when Zone 2 is on.
- 3 **Listening mode and format indicators (52)**  
Show the selected listening mode and the format of digital input signals.
- 4 **Tuning indicators (43)**
  - TUNED (43):** Lights up when tuned to a radio station.
  - AUTO (43):** For AM and FM radio, lights up when Auto Tuning mode is selected, and disappears when Manual Tuning mode is selected.
  - MEMORY (48):** Lights up when presetting radio stations.
  - FM STEREO (43):** Lights up when tuned to a stereo FM station.
- 5 **SLEEP indicator (51)**  
Lights up when the Sleep function has been set.
- 6 **Message area**  
Displays various information about the selected input source.

## Getting to Know the AV Receiver—Continued

### Rear Panel

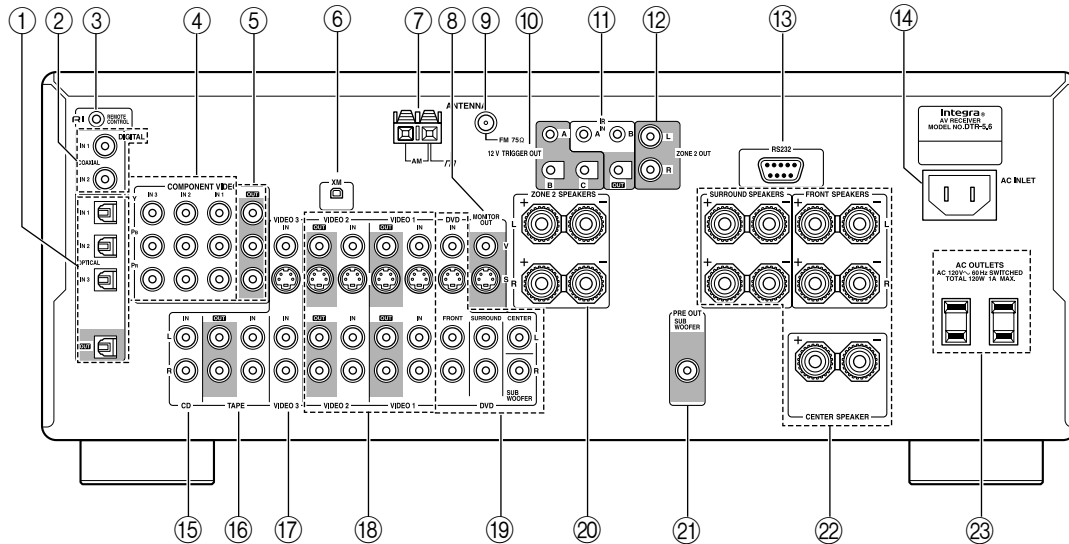

#### ① OPTICAL DIGITAL

These optical digital audio inputs are for connecting components with optical digital audio outputs, such as CD players and DVD players.

The optical digital audio output is for connecting a digital recorder with an optical digital input, such as a CD recorder.

#### ② COAXIAL DIGITAL

These coaxial digital audio inputs are for connecting components with coaxial digital audio outputs, such as CD players and DVD players.

#### ③ RI REMOTE CONTROL

This **RI** (Remote Interactive) jack can be connected to the **RI** jack on another **RI**-capable Integra component, for remote and system control.

To use **RI**, you must make an analog audio connection (RCA) between the AV receiver and the other component, even if they are connected digitally.

#### ④ COMPONENT VIDEO IN 1, 2, and 3

These RCA component video inputs are for connecting components with component video outputs, such as DVD players.

#### ⑤ COMPONENT VIDEO OUT

This RCA component video output is for connecting a TV or projector with a component video input.

#### ⑥ XM antenna

This jack is for connecting an XM digital antenna, sold separately.

#### ⑦ AM ANTENNA

These push terminals are for connecting an AM antenna.

#### ⑧ MONITOR OUT

The S-Video or composite video jack should be connected to a video input on your TV or projector.

#### ⑨ FM ANTENNA

This jack is for connecting an FM antenna.

#### ⑩ 12V TRIGGER OUT (A/B/C)

These outputs can be connected to the 12-volt trigger inputs on other components.

#### ⑪ IR IN A/B and OUT

A commercially available IR receiver can be connected to the IR IN A or B jack, allowing you to control the AV receiver while you're in Zone 2, or control it when it's out of sight, for example, installed in a cabinet.

A commercially available IR emitter can be connected to the IR OUT jack to pass IR (infrared) remote control signals along to other components.

#### ⑫ ZONE 2 OUT L/R

The L/R jacks can be connected to a line input on an amplifier in Zone 2.

#### ⑬ RS232

This port is for connecting the AV receiver to home automation equipment and external controllers.

#### ⑭ AC INLET

This connector is for connecting the supplied power cord.

#### ⑮ CD IN

This analog audio input is for connecting a CD player's analog audio output.

## Getting to Know the AV Receiver—Continued

---

### 16 TAPE IN/OUT

This analog audio input and output are for connecting a recorder with an analog audio input and output, such as a cassette deck, MD recorder, etc.

### 17 VIDEO 3 IN

A VCR for playback only, or a cable or satellite receiver can be connected here. There's S-Video and composite video input jacks for connecting the video signal.

### 18 VIDEO 1 IN/OUT and VIDEO 2 IN/OUT

One or two video components can be connected here for recording and playback, such as a VCR. There's S-Video and composite video input and output jacks for connecting the video signal.

### 19 DVD IN

This input are for connecting a DVD player. There's S-Video and composite video input jacks for connecting the video signal, and stereo (FRONT) and multichannel 5.1 jacks for connecting the analog audio signals.

### 20 ZONE 2 SPEAKERS

These terminal posts are for connecting speakers in Zone 2.

### 21 PRE OUT SUBWOOFER

This jack is for connecting a powered subwoofer.

### 22 FRONT, CENTER, and SURROUND SPEAKERS

These terminal posts are for connecting the front L/R, center, and surround L/R speakers.

### 23 AC OUTLETS

These switched AC outlets can be used to supply power to other AV components. The type and number of outlets depends on the country in which you purchased your AV receiver.

See pages 17–34 for hookup information.

# Remote Controller

## About the Remote Controller Modes

Including the AV receiver, the remote controller can be used to control up to nine different components. The remote controller has a specific operating mode for use with each type of component. Modes are selected by using the eight Remote Mode buttons.

### Receiver/Tape Mode

In Receiver/Tape mode, you can control the AV receiver and an Integra cassette recorder connected via **RI**.

### DVD Mode

By default, you can control an Integra DVD player in this mode. By entering the appropriate remote control code, you can control components made by other manufacturers (see page 72).

### CD Mode

By default, you can control an Integra CD player in this mode. By entering the appropriate remote control code, you can control a CD player, MD recorder, or CD recorder made by another manufacturer (see page 72).

### HDD Mode

This mode is for controlling Integra's next generation HDD-compatible components via **RI**.

### TV and VCR Modes

With these modes, you can control a TV and VCR. You must enter the appropriate remote control code first (see page 72).

### Cable/CDR and SAT/MD Modes

In Cable/CDR mode, you can control an Integra CD recorder or a cable TV receiver. In SAT/MD mode, you can control an Integra MD recorder or a satellite TV receiver. You must enter the appropriate remote control code first (see page 72).

**1** Use the Remote Mode buttons to select a mode.

**2** Use the buttons supported by that mode to control the component.

Receiver/Tape mode: see page 12

DVD mode: see page 14

CD/MD/CDR modes: see page 15

HDD mode: see page 16

TV/VCR/SAT/Cable modes: see page 74

#### Note:

Some of the remote controller operations described in this manual may not work as expected with other components.

## Receiver/Tape Mode

Receiver/Tape mode is used to control the AV receiver. It can also be used to control an Integra cassette recorder connected via **RI**.

To set the remote controller to Receiver/Tape mode, press the [Receiver] Remote Mode button.

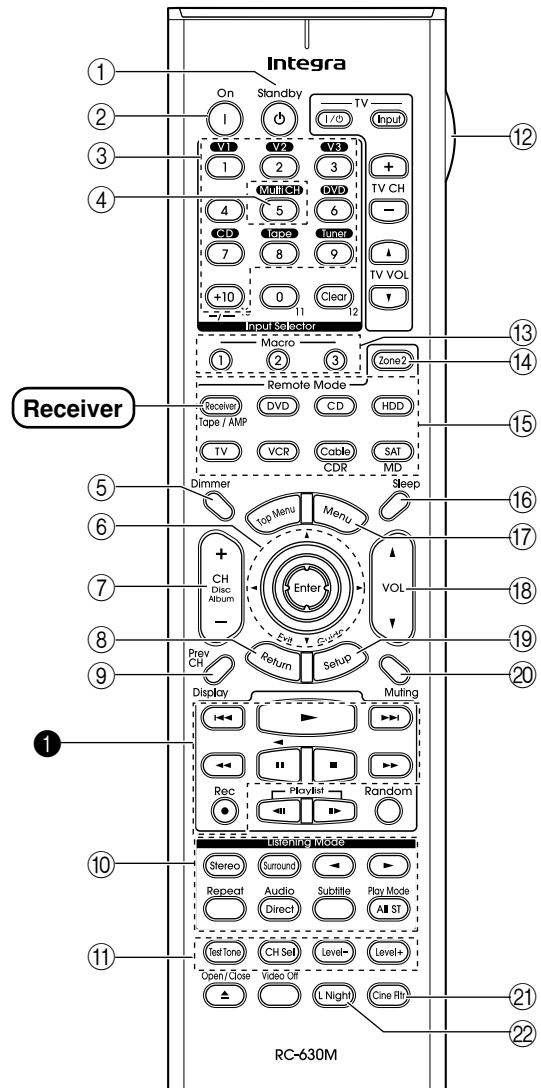

## Remote Controller—Continued

For detailed information, see the pages in parentheses.

- ① **Standby button (35)**  
Sets the AV receiver to Standby.
- ② **On button (35)**  
Turns on the AV receiver.
- ③ **Input Selector buttons (42)**  
Used to select the input sources.
- ④ **Multi CH button (49)**  
Selects the multichannel DVD input.
- ⑤ **Dimmer button (50)**  
Adjusts the display brightness.
- ⑥ **Arrow [▲]/[▼]/[◀]/[▶] and Enter buttons**  
Used to select and adjust settings.
- ⑦ **CH +/- button (48)**  
Selects radio presets.
- ⑧ **Return button**  
Returns to the previous display when changing settings.
- ⑨ **Display button (51)**  
Displays various information about the currently selected input source.
- ⑩ **Listening Mode buttons (52)**  
Used to select the listening modes. The [Stereo], [Surround], and Listening Mode [◀]/[▶] buttons can be used regardless of the currently selected remote controller mode.
- ⑪ **Test Tone, CH Sel, Level-, and Level+ buttons (38, 50)**  
Used to adjust the level of each speaker.
- ⑫ **Light button**  
Turns the remote controller's illuminated buttons on or off.
- ⑬ **Macro buttons (76)**  
Used with the Macro function.
- ⑭ **Zone 2 (68)**  
Used when setting the volume and input source for Zone 2.
- ⑮ **Remote Mode buttons (12)**  
Used to select the remote controller modes. When a remote controller button is pressed, the Remote Mode button of the currently selected mode lights up.
- ⑯ **Sleep button (51)**  
Used with the Sleep function.
- ⑰ **Menu button (45)**  
Selects the search mode for XM Satellite Radio.
- ⑱ **VOL [▲]/[▼] button (42)**  
Adjusts the volume of the AV receiver regardless of the currently selected remote controller mode.
- ⑲ **Setup button**  
Used to change settings.

- ⑳ **Muting button (50)**  
Mutes or unmutes the AV receiver.
- ㉑ **Cine Filtr button (57)**  
Turns the Cine Filter function on or off.
- ㉒ **L Night button (59)**  
Turns the Late Night function on or off.

### ■ Tape mode

On twin cassette decks, only Deck B can be controlled.

#### ① Previous and Next [◀◀]/[▶▶] buttons

The Previous [◀◀] button selects the previous track. During playback it selects the beginning of the current track. The Next [▶▶] button selects the next track.

Depending on how they were recorded, the Previous and Next [◀◀]/[▶▶] buttons may not work properly with some cassette tapes.

#### Play [▶] button

Starts playback.

#### Rewind and FF [◀◀]/[▶▶] buttons

The Rewind [◀◀] button starts rewind. The FF [▶▶] button starts fast forward.

#### Reverse Play [◀] button

Starts reverse playback.

#### Stop [■] button

Stops playback.

#### Rec [●] button

Starts recording.

## Remote Controller—Continued

### DVD Mode

To set the remote controller to DVD mode, press the [DVD] Remote Mode button.

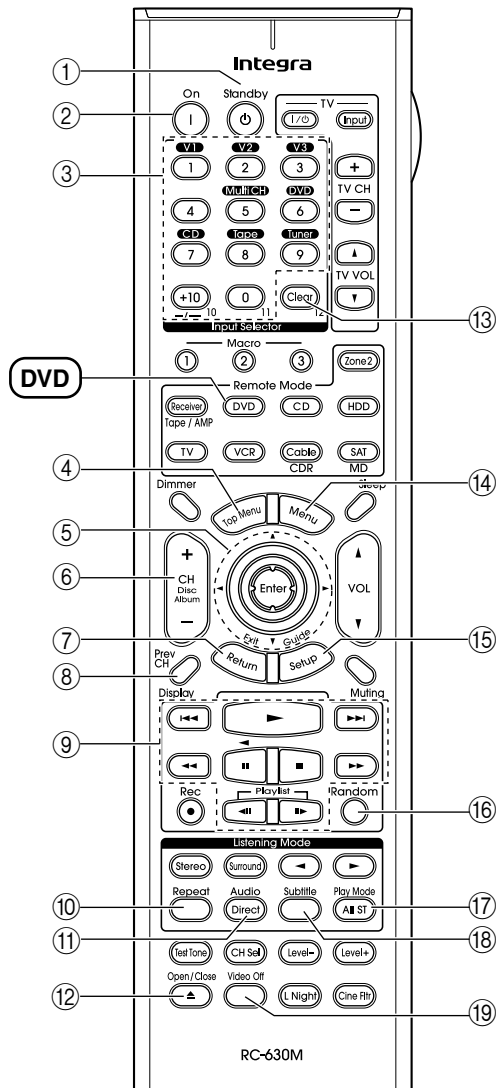

- ① **Standby button**  
Sets the DVD player to Standby.
- ② **On button**  
Turns on the DVD player.
- ③ **Number buttons**  
Used to enter title, chapter, and track numbers, and to enter times for locating specific points.
- ④ **Top Menu button**  
Selects a DVD's top menu.
- ⑤ **Arrow [▲]/[▼]/[◀]/[▶] and Enter buttons**  
Used to navigate menus and select items.
- ⑥ **Disc +/- button**  
Selects discs on a DVD changer.
- ⑦ **Return button**  
Exits the DVD player's onscreen setup menu.
- ⑧ **Display button**  
Displays information about the current disc, title, chapter, or track, including elapsed time, remaining time, total time, and so on.
- ⑨ **Playback buttons**  
From left to right: Previous, Play, Next, Rewind, Pause, Stop, Fast Forward, Slow Reverse, and Slow Forward.
- ⑩ **Repeat button**  
Used with the repeat playback function.
- ⑪ **Audio button**  
Selects foreign language soundtracks and audio formats (e.g., Dolby Digital or DTS).
- ⑫ **Open/Close [▲] button**  
Opens and closes the disc tray.
- ⑬ **Clear button**  
Cancels functions and clears entered numbers.
- ⑭ **Menu button**  
Displays a DVD's menu.
- ⑮ **Setup button**  
Used to access the DVD player's settings.
- ⑯ **Random button**  
Used with the random playback function.
- ⑰ **Play Mode button**  
Selects play modes on components with selectable play modes.
- ⑱ **Subtitle button**  
Selects subtitles.
- ⑲ **Video Off button**  
Turns off the internal video circuitry, eliminating any possibility of interference.

## Remote Controller—Continued

### CD, MD, and CDR Modes

To control an Integra CD player or a CD/MD recorder made by another manufacturer, press the [CD] Remote Mode button to select the CD remote controller mode.

To control an Integra MD recorder or CD recorder, press the [MD] or [CDR] Remote Mode button to select the MD or CDR remote controller mode.

In order to control an Integra MD recorder or CD recorder, or a component made by another manufacturer, you must first enter the appropriate remote control code (see page 72).

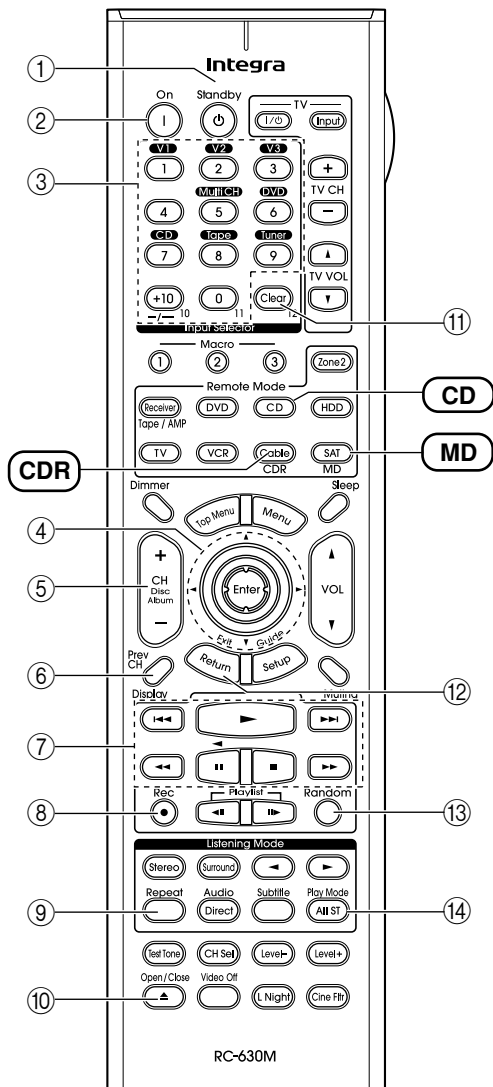

- ① **Standby button**  
Sets the CD player or MD/CD recorder to Standby.
- ② **On button**  
Set the CD player or MD/CD recorder to On or Standby.
- ③ **Number buttons**  
Used to enter track numbers and times for locating specific points.
- ④ **Arrow [▲]/[▼]/[◀]/[▶] and Enter buttons**  
Used with some components.
- ⑤ **Disc +/- button**  
Selects discs on a CD changer.
- ⑥ **Display button**  
Displays information about the current disc or track, including elapsed time, remaining time, total time, and so on.
- ⑦ **Playback buttons**  
From left to right: Previous, Play, Next, Rewind, Pause, Stop, and Fast Forward.
- ⑧ **Rec [●] button**  
Starts recording.
- ⑨ **Repeat button**  
Used with the repeat playback function.
- ⑩ **Open/Close [▲] button**  
Opens and closes the disc tray or ejects the Mini-Disc.
- ⑪ **Clear button**  
Cancels functions and clears entered numbers.
- ⑫ **Return button**  
Used with some components.
- ⑬ **Random button**  
Used with the random playback function.
- ⑭ **Play Mode button**  
Selects play modes on components with selectable play modes.

## Remote Controller—Continued

### HDD Mode

HDD mode is for controlling Integra's next generation HDD-compatible components. As of 2005, it can be used with the Onkyo DS-A1 Remote Interactive Dock and Apple iPod connected via **RI**.

#### When Using the Onkyo DS-A1:

- Connect the DS-A1 to the TAPE IN or VIDEO 3 IN jacks.
- Set the DS-A1's RI MODE switch to HDD.
- Set the AV receiver's input display to HDD (see page 41).
- Refer to the DS-A1's instruction manual.

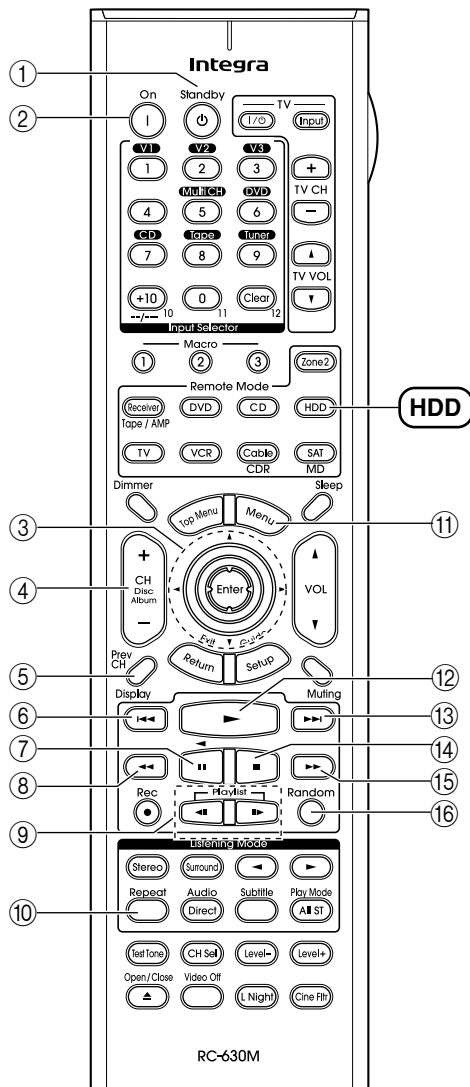

- 1 **Standby button**  
Turns off the HDD-compatible component.
- 2 **On button\***  
Turns on the HDD-compatible component.
- 3 **Arrow [▲]/[▼] and Enter buttons\***  
Used to navigate menus and select items.
- 4 **Album +/- button\***  
Selects the next or previous album.
- 5 **Display button\***  
Turns on the backlight for 30 seconds.
- 6 **Previous [◀◀] button**  
Restarts the current song. Press it twice to select the previous song.
- 7 **Pause [||] button**  
Pauses playback. (With 3rd generation iPods, it works as a Play/Pause button.)
- 8 **Rewind [◀◀] button**  
Press and hold to rewind.
- 9 **Playlist [◀||]/[||▶] buttons\***  
Used to select the previous or next playlist on the HDD-compatible component.
- 10 **Repeat button\***  
Used with the repeat function.
- 11 **Menu button\***  
Used to access menus.
- 12 **Play [▶] button**  
Starts playback. If the component is off, it will turn on automatically. (With 3rd generation iPods, this button works as a Play/Pause button.)
- 13 **Next [▶▶] button**  
Selects the next song.
- 14 **Stop [■] button**  
Stops playback and displays a menu.
- 15 **Fast Forward [▶▶] button**  
Press and hold to fast forward.
- 16 **Random button\***  
Used with the shuffle function.

\* Buttons marked with an asterisk (\*) are not supported by 3rd generation iPods.



# Connecting Your Speakers

## Enjoying Home Theater

Thanks to the AV receiver's superb capabilities, you can enjoy surround sound with a real sense of movement in your own home—just like being in a movie theater or concert hall. You can enjoy DVDs featuring DTS and Dolby Digital. With analog and digital TV, you can enjoy Dolby Pro Logic II and Onkyo's own DSP surround listening modes.

### Front left and right speakers

These output the overall sound. Their role in a home theater is to provide a solid anchor for the sound image. They should be positioned facing the listener at about ear level, and equally spaced from the TV. Angle them inward slightly so as to create a triangle, with the listener at the apex.

### Center speaker

This speaker enhances the front left and right speakers, making sound movements distinct and providing a full sound image. For movies it's used mainly for dialog.

Position it close to your TV (preferably on top) facing forward at about ear level, or at the same height as the front left and right speakers.

### Subwoofer

The subwoofer handles the bass sounds of the LFE (Low-Frequency Effects) channel. The volume and quality of the bass output from your subwoofer will depend on its position, the shape of your listening room, and your listening position. In general, a good bass sound can be obtained by installing the subwoofer in a front corner, or at one-third the way along the wall, as shown.

**Tip:** To find the best position for your subwoofer, while playing a movie or some music with good bass, experiment by placing your subwoofer at various positions within the room, and choose the one that provides the most satisfying results.

### Surround left and right speakers

These speakers are used for precise sound positioning and to add realistic ambience.

Position them at the sides of the listener, or slightly behind, about 2–3 feet (60–100 cm) above ear level. Ideally they should be equally spaced from the listener.

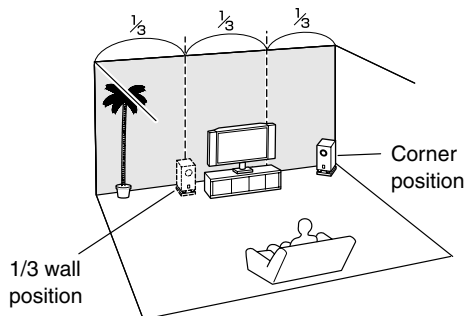
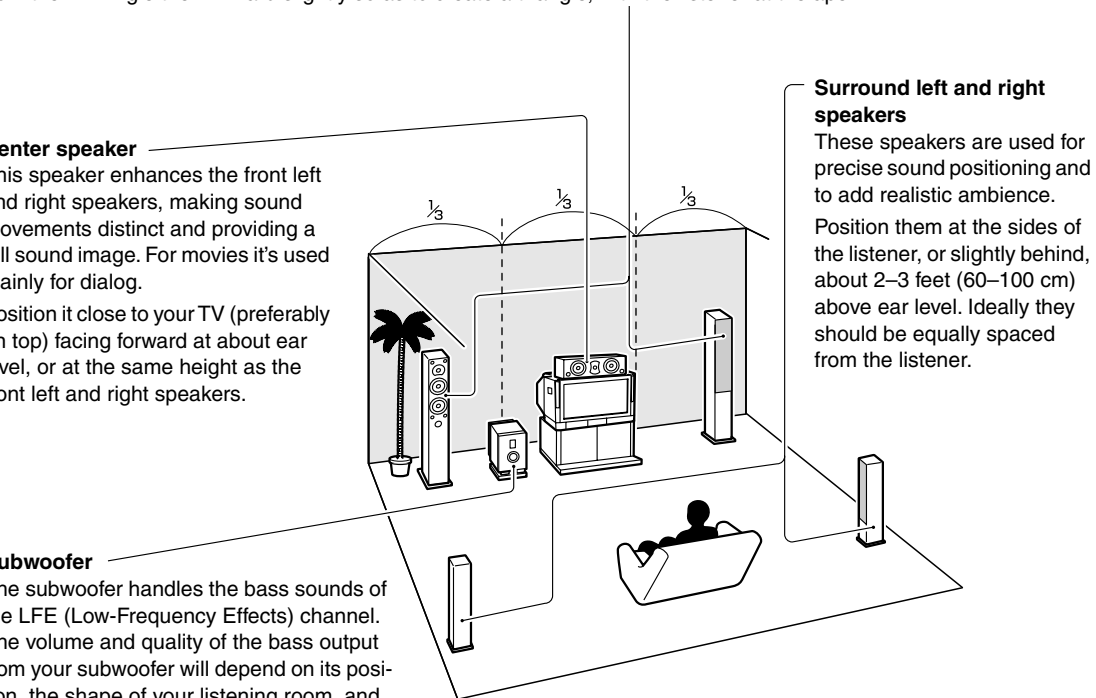

## Connecting Your Speakers—Continued

### Connecting Your Speakers

#### Speaker Configuration

For the best surround-sound experience, you should connect five speakers and a powered subwoofer.

The following table shows which channels you should use based on the number of speakers you have.

Number of speakers:	2	3	4	5
Front left	✓	✓	✓	✓
Front right	✓	✓	✓	✓
Center		✓		✓
Surround left			✓	✓
Surround right			✓	✓

No matter how many speakers you use, a powered subwoofer is recommended for a really powerful and solid bass.

#### Using Dipole Speakers

You can use dipole speakers for the surround left and right speakers. Dipole speakers output the same sound in two directions.

Dipole speakers typically have an arrow printed on them to indicate how they should be positioned. The surround left and right dipole speakers should be positioned so that their arrows point toward the TV/screen.

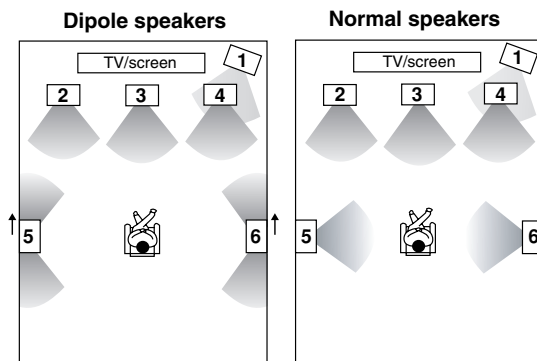

1. Subwoofer
2. Front left speaker
3. Center speaker
4. Front right speaker
5. Surround left speaker
6. Surround right speaker

### Connecting a Powered Subwoofer

Using a suitable cable, connect the AV receiver's PRE OUT SUBWOOFER to the input on your powered subwoofer. If your subwoofer is unpowered and you're using an external amplifier, connect the PRE OUT SUBWOOFER to the amp's input.

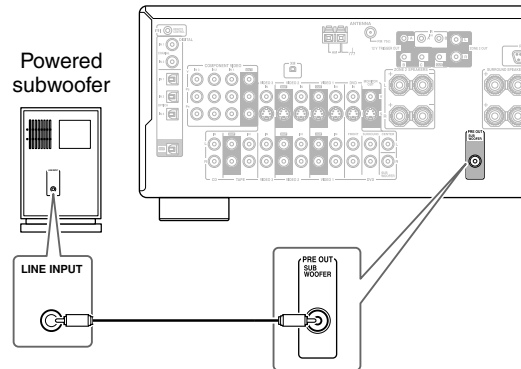

### Attaching the Speaker Labels

The AV receiver's positive (+) speaker terminals are color-coded for ease of identification. (The negative (-) speaker terminals are all black.)

Speaker terminal	Color
Front left, Zone 2 left	White
Front right, Zone 2 right	Red
Center	Green
Surround left	Blue
Surround right	Gray

The supplied speaker labels are also color-coded and you should attach them to the positive (+) side of each speaker cable in accordance with the above table. All you need to do then is to match the color of each label to the corresponding speaker terminal.



## Connecting Your Speakers—Continued

### Speaker Connection Precautions

Read the following before connecting your speakers:

- Only connect speakers with an impedance of 6 ohms or higher. If you use speakers with a lower impedance, and use the amplifier at high volume levels for a long period of time, the built-in protection circuit may be activated.
- Disconnect the power cord from the wall outlet before making any connections.
- Read the instructions supplied with your speakers.
- Pay close attention to speaker wiring polarity. In other words, connect positive (+) terminals to only positive (+) terminals, and negative (–) terminals to only negative (–) terminals. If you get them the wrong way around, the sound will be out of phase and will sound unnatural.
- Unnecessarily long or very thin speaker cables may affect the sound quality and should be avoided.
- Be careful not to short the positive and negative wires. Doing so may damage the AV receiver.
- Don't connect more than one cable to each speaker terminal. Doing so may damage the AV receiver.
- Don't connect a speaker to several terminals.

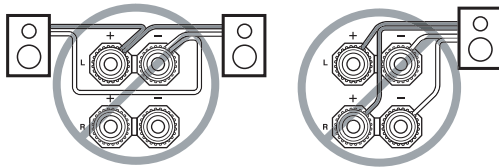
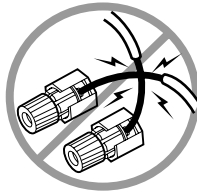

### Connecting the Speaker Cables

- 1 Strip about 5/8" (15 mm) of insulation from the ends of the speaker cables, and twist the bare wires tightly, as shown.**
- 2 Unscrew the terminal.**
- 3 Fully insert the bare wires.**
- 4 Screw the terminal tight.**

The following illustration shows which speaker should be connected to each pair of terminals.

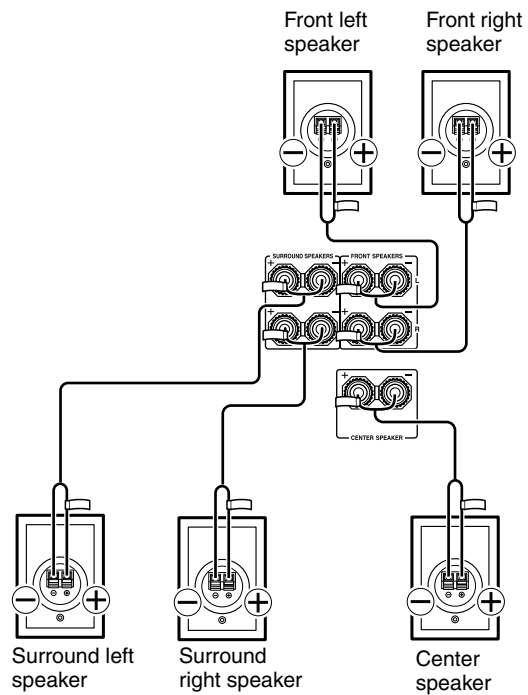

# Connecting Antenna

This section explains how to connect the supplied indoor FM antenna and AM loop antenna, and how to connect commercially available outdoor FM and AM antennas. The AV receiver won't pick up any radio signals without any antenna connected, so you must connect the antenna to use the tuner.

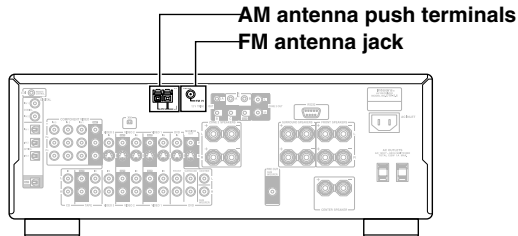

## Connecting the Indoor FM Antenna

The supplied indoor FM antenna is for indoor use only.

### 1 Attach the FM antenna, as shown.

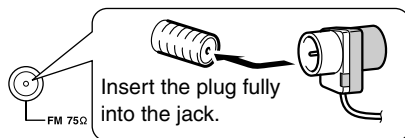

Once your AV receiver is ready for use, you'll need to tune into an FM radio station and adjust the position of the FM antenna to achieve the best possible reception.

### 2 Use thumbtacks or something similar to fix the FM antenna into position.

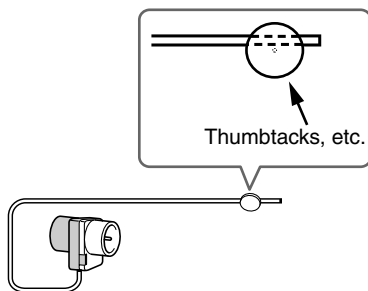

**Caution:** Be careful that you don't injure yourself when using thumbtacks.

If you cannot achieve good reception with the supplied indoor FM antenna, try a commercially available outdoor FM antenna instead (see page 21).

## Connecting the AM Loop Antenna

The supplied indoor AM loop antenna is for indoor use only.

### 1 Assemble the AM loop antenna, inserting the tabs into the base, as shown.

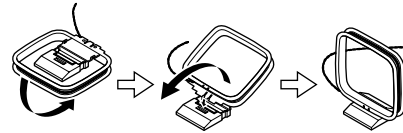

### 2 Connect both wires of the AM loop antenna to the AM push terminals, as shown.

(The antenna's wires are not polarity sensitive, so they can be connected either way around). Make sure that the wires are attached securely and that the push terminals are gripping the bare wires, not the insulation.

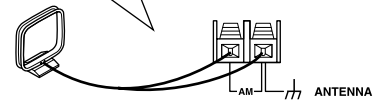
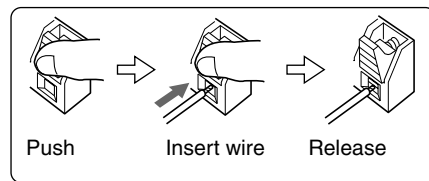

Once your AV receiver is ready for use, you'll need to tune into an AM radio station and adjust the position of the AM antenna to achieve the best possible reception.

Keep the antenna as far away as possible from your AV receiver, TV, speaker cables, and power cords.

If you cannot achieve good reception with the supplied indoor AM loop antenna, try using it with a commercially available outdoor AM antenna (see page 21).

## Connecting Antenna—Continued

### Connecting an Outdoor FM Antenna

If you cannot achieve good reception with the supplied indoor FM antenna, try a commercially available outdoor FM antenna instead.

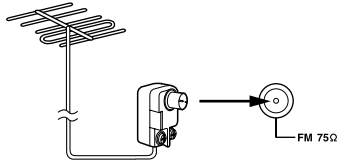

#### Notes:

- Outdoor FM antennas work best outside, but usable results can sometimes be obtained when installed in an attic or loft.
- For best results, install the outdoor FM antenna well away from tall buildings, preferably with a clear line of sight to your local FM transmitter.
- Outdoor antenna should be located away from possible noise sources, such as neon signs, busy roads, etc.
- For safety reasons, outdoor antenna should be situated well away from power lines and other high-voltage equipment.
- Outdoor antenna must be grounded in accordance with local regulations to prevent electrical shock hazards.

#### ■ Using a TV/FM Antenna Splitter

It's best not to use the same antenna for both FM and TV reception, as this can cause interference problems. If circumstances demand it, use a TV/FM antenna splitter, as shown.

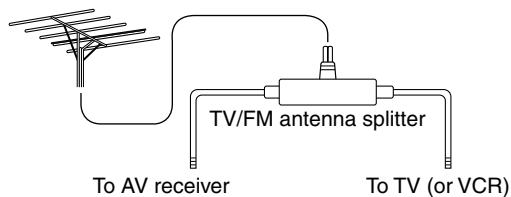

### Connecting an Outdoor AM Antenna

If good reception cannot be achieved using the supplied AM loop antenna, an outdoor AM antenna can be used in addition to the loop antenna, as shown.

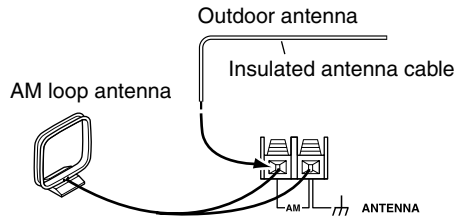

Outdoor AM antennas work best when installed horizontally outside, but good results can sometimes be obtained indoors by mounting horizontally above a window. Note that the AM loop antenna should be left connected.

Outdoor antenna must be grounded in accordance with local regulations to prevent electrical shock hazards.

# Connecting Your Components

## About AV Connections

- Before making any AV connections, read the manuals supplied with your other AV components.
- Don't connect the power cord until you've completed and double-checked all AV connections.

### Optical Digital Jacks

The AV receiver's optical digital jacks have shutter-type covers that open when an optical plug is inserted and close when it's removed. Push plugs in all the way.

**Caution:** To prevent shutter damage, hold the optical plug straight when inserting and removing.

## AV Connection Color Coding

RCA-type AV connections are usually color coded: red, white, and yellow. Use red plugs to connect right-channel audio inputs and outputs (typically labeled "R"). Use white plugs to connect left-channel audio inputs and outputs (typically labeled "L"). And use yellow plugs to connect composite video inputs and outputs.

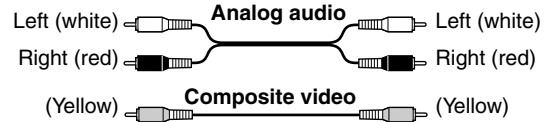

- Push plugs in all the way to make good connections (loose connections can cause noise or malfunctions).
- To prevent interference, keep audio and video cables away from power cords and speaker cables.

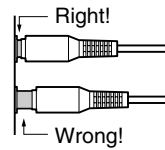

## AV Cables and Jacks

### Video

Cable	Jack	Description
		Component video separates the luminance (Y) and color difference signals (Pr, Pb), providing the best picture quality. (Some TV manufacturers label their component video jacks slightly differently.)
		S-Video separates the luminance and color signals and provides better picture quality than composite video.
		Composite video is commonly used on TVs, VCRs, and other video equipment.

### Audio

Cable	Jack	Description
		This offers the best sound quality and allows you to enjoy Dolby Digital and DTS. The audio quality is the same as for coaxial.
		This offers the best sound quality and allows you to enjoy Dolby Digital and DTS. The audio quality is the same as for optical.
		This cable carries analog audio. It's the most common connection format for analog audio and can be found on virtually all AV components.
		This cable carries multichannel analog audio and is typically used to connect DVD players with a 5.1-channel analog audio output. Several standard analog audio cables can be used instead of a multichannel cable.

**Note:** The AV receiver does not support SCART connections.

## Connecting Your Components—Continued

### Connecting Audio and Video Signals to the AV Receiver

By connecting both the audio and video outputs of your DVD player and other AV components to the AV receiver, you can switch the audio and video signals simultaneously simply by changing the input source on the AV receiver.

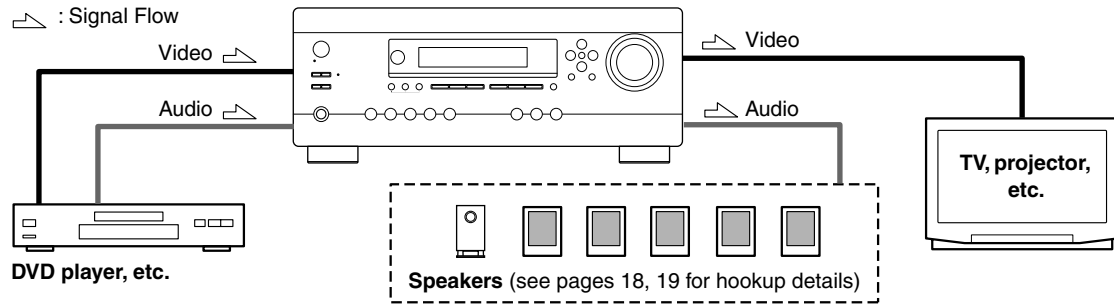

### Which Connections Should I Use?

The AV receiver supports several connection formats for compatibility with a wide range of AV equipment. The format you choose will depend on the formats supported by your other components. Use the following sections as a guide. For video components, you must make an audio connection and a video connection.

#### Video Connection Formats

Video equipment can be connected to the AV receiver by using any one of the following video connection formats: composite video, S-Video, or component video, the latter offering the best picture quality.

Composite video to S-Video and S-Video to composite video conversion only applies to the MONITOR OUT V and S outputs, not the VIDEO 1 and VIDEO 2 OUT V and S outputs.

**Note:** The AV receiver can be set to upconvert composite video and S-Video input signals and output them from the COMPONENT VIDEO OUT (see page 39).

#### Video Signal Flow Chart

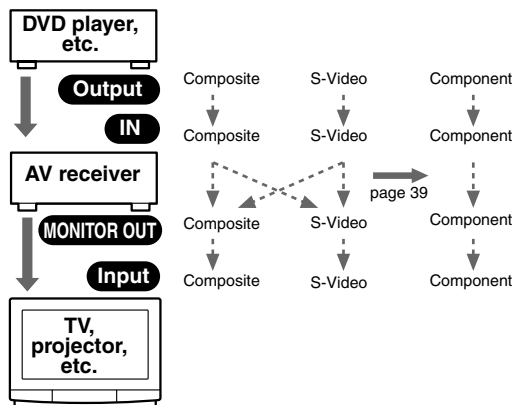

#### Audio Connection Formats

Audio equipment can be connected to the AV receiver by using any of the following audio connection formats: analog, optical, coaxial, or analog multichannel.

When choosing a connection format, bear in mind that the AV receiver does not convert digital input signals for analog line output and vice versa. For example, audio signals connected to an OPTICAL or COAXIAL input are not output by the analog TAPE OUT.

#### Audio Signal Flow Chart

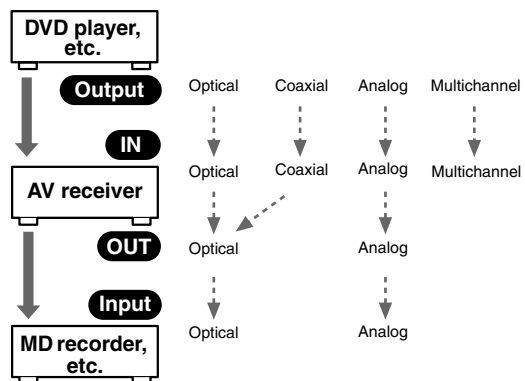

## Connecting Your Components—Continued

### Connecting a TV or Projector

#### Step 1: Video Connection

Choose a video connection that matches your TV (**A**, **B**, or **C**), and then make the connection.

#### Step 2: Audio Connection

Choose an audio connection that matches your TV (**a**, **b**, or **c**), and then make the connection.

- With connection **a**, you can listen to and record audio from your TV and listen in Zone 2.
- To enjoy Dolby Digital and DTS, use connection **b** or **c**. (For Zone 2, use **a** and **b**, or **a** and **c**.)

Connection	AV receiver	Signal flow	TV	Picture quality
<b>A</b>	COMPONENT VIDEO OUT	⇒	Component video input	Best
<b>B</b>	MONITOR OUT S	⇒	S-Video input	Better
<b>C</b>	MONITOR OUT V	⇒	Composite video input	Standard
<b>a</b>	VIDEO 3 IN L/R	←	Analog audio L/R output	
<b>b</b>	DIGITAL COAXIAL IN 2	←	Digital coaxial output	
<b>c</b>	DIGITAL OPTICAL IN 2	←	Digital optical output	

#### Hint!

If your TV has no audio outputs, connect an audio output from your VCR to the AV receiver and use its tuner to listen to TV programs through the AV receiver.

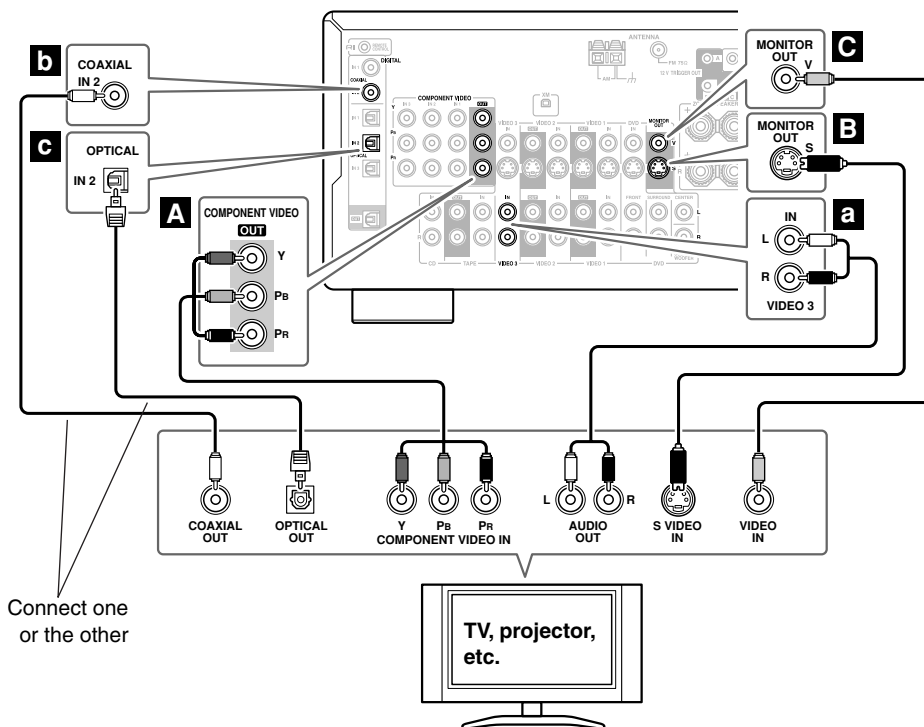



## Connecting Your Components—Continued

### Connecting a DVD player

#### Step 1: Video Connection

Choose a video connection that matches your DVD player (**A**, **B**, or **C**), and then make the connection. If you use connection **A**, you must connect the AV receiver to your TV with the same type of connection.

#### Step 2: Audio Connection

Choose an audio connection that matches your DVD player (**a**, **b**, or **c**), and then make the connection.

- With connection **a**, you can listen to and record audio from a DVD and listen in Zone 2.
- To enjoy Dolby Digital and DTS, use connection **b** or **c**. (For Zone 2, use **a** and **b**, or **a** and **c**.)
- If your DVD player has main left and right outputs and multichannel left and right outputs, be sure to use the main left and right outputs for connection **a**.

Connection	AV receiver	Signal flow	DVD player	Picture quality
<b>A</b>	COMPONENT VIDEO IN 1	←	Component video output	Best
<b>B</b>	DVD IN S	←	S-Video output	Better
<b>C</b>	DVD IN V	←	Composite video output	Standard
<b>a</b>	DVD IN FRONT	←	Analog audio L/R output	
<b>b</b>	DIGITAL COAXIAL IN 1	←	Digital coaxial output	
<b>c</b>	DIGITAL OPTICAL IN 3	←	Digital optical output	

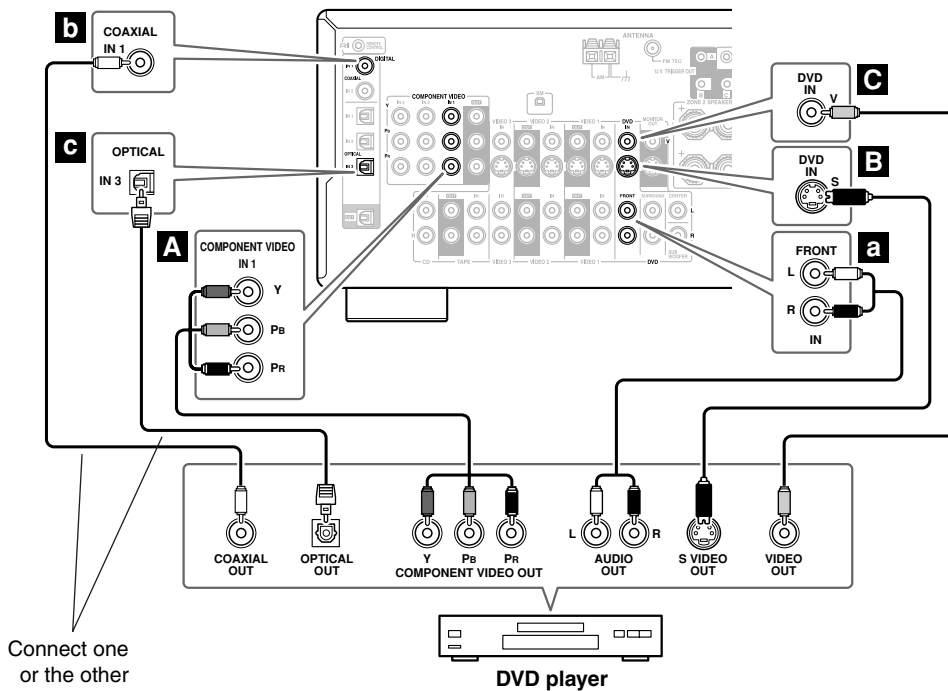

Connect one or the other

To connect a DVD player or DVD-Audio/SACD-capable player with a multichannel analog audio output, see page 26.

## Connecting Your Components—Continued

### Hooking Up the Multichannel DVD Input

If your DVD player supports multichannel audio formats such as DVD-Audio or SACD, and it has a multichannel analog audio output, you can connect it to the AV receiver's multichannel DVD input.

Use a multichannel analog audio cable, or several normal audio cables, to connect the AV receiver's DVD IN FRONT L/R, CENTER, SURROUND L/R, and SUBWOOFER jacks to the 5.1-channel analog audio output on your DVD player. See "Using the Multichannel DVD Input" on page 49 for setup and operation.

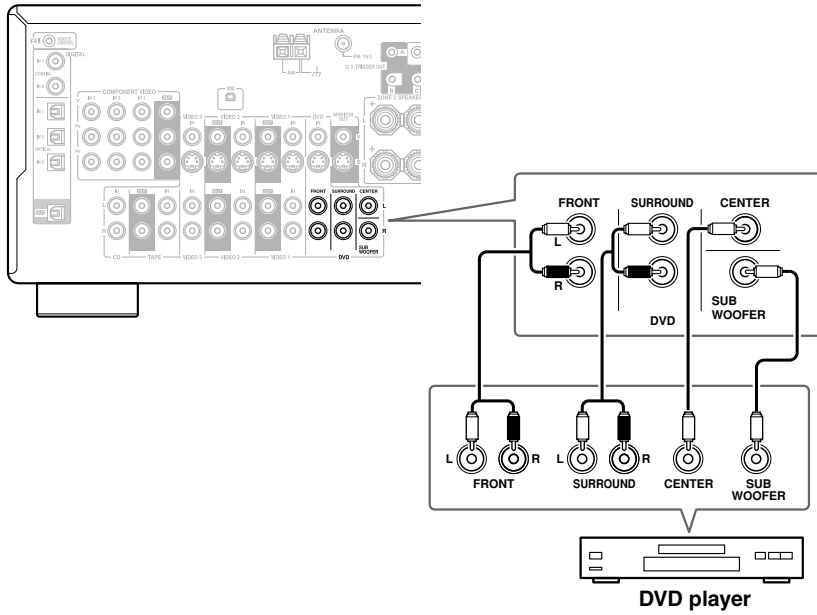

## Connecting Your Components—Continued

### Connecting a VCR or DVD Recorder for Playback

In addition to video playback, with this hookup, you can use your VCR's tuner to listen to your favorite TV programs via the AV receiver, useful if your TV has no audio outputs.

If you have two video recorders (e.g., a VCR and a DVD recorder), connect one recorder to the VIDEO 1 IN jacks, as shown here, and connect the other recorder to the VIDEO 2 IN jacks in the same way.

#### Step 1: Video Connection

Choose a video connection that matches your VCR or DVD recorder (**A**, **B**, or **C**), and then make the connection. If you use connection **A**, you must connect the AV receiver to your TV with the same type of connection.

#### Step 2: Audio Connection

Choose an audio connection that matches your VCR or DVD recorder (**a**, **b**, or **c**), and then make the connection.

- With connection **a**, you can listen to the VCR or DVD recorder even in Zone 2.
- To enjoy Dolby Digital and DTS, use connection **b** or **c**. (To listen in Zone 2 as well, use **a** and **b**, or **a** and **c**.)

Connection	AV receiver	Signal flow	VCR or DVD recorder	Picture quality
<b>A</b>	COMPONENT VIDEO IN 2	←	Component video output	Best
<b>B</b>	VIDEO 1 IN S	←	S-Video output	Better
<b>C</b>	VIDEO 1 IN V	←	Composite video output	Standard
<b>a</b>	VIDEO 1 IN L/R	←	Analog audio L/R output	
<b>b</b>	DIGITAL COAXIAL IN 2	←	Digital coaxial output	
<b>c</b>	DIGITAL OPTICAL IN 1	←	Digital optical output	

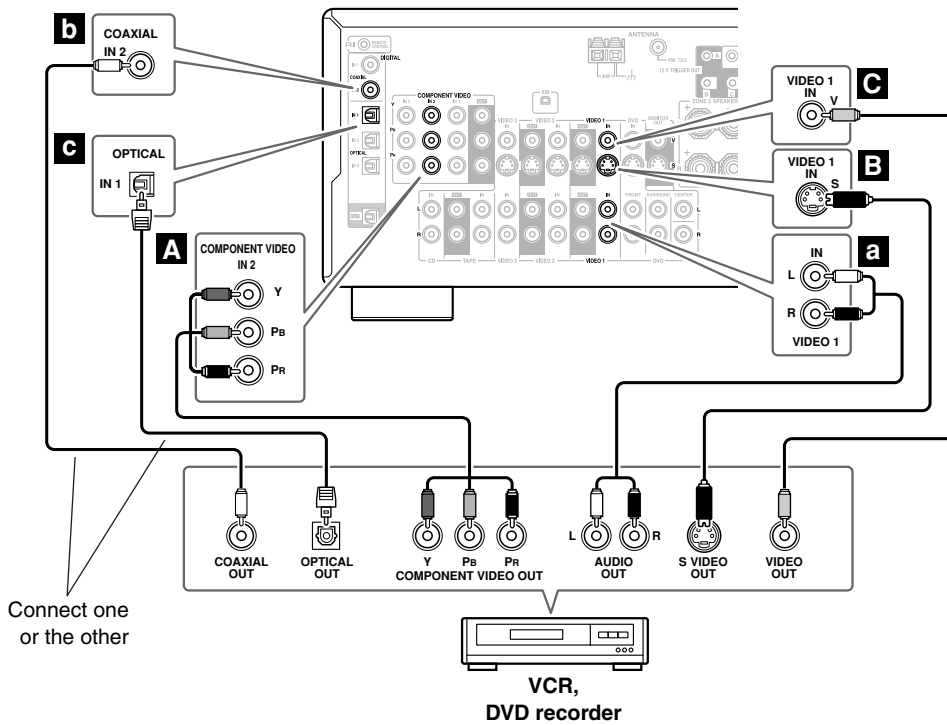

## Connecting Your Components—Continued

### Connecting a VCR or DVD Recorder for Recording

If you have two video recorders (e.g., a VCR and a DVD recorder), connect one recorder to the VIDEO 1 OUT jacks, as shown here, and connect the other recorder to the VIDEO 2 OUT jacks in the same way.

#### Step 1: Video Connection

Choose a video connection that matches your VCR or DVD recorder (**A** or **B**), and then make the connection. The video source to be recorded must be connected to the AV receiver via the same type of connection.

#### Step 2: Audio Connection

Choose an audio connection that matches your VCR or DVD recorder (**a** or **b**), and then make the connection.

Connection	AV receiver	Signal flow	VCR or DVD recorder	Picture quality
<b>A</b>	VIDEO 1 OUT S	⇒	S-Video input	Better
<b>B</b>	VIDEO 1 OUT V	⇒	Composite video input	Standard
<b>a</b>	VIDEO 1 OUT L/R	⇒	Audio L/R input	
<b>b</b>	DIGITAL OPTICAL OUT	⇒	Digital optical input	

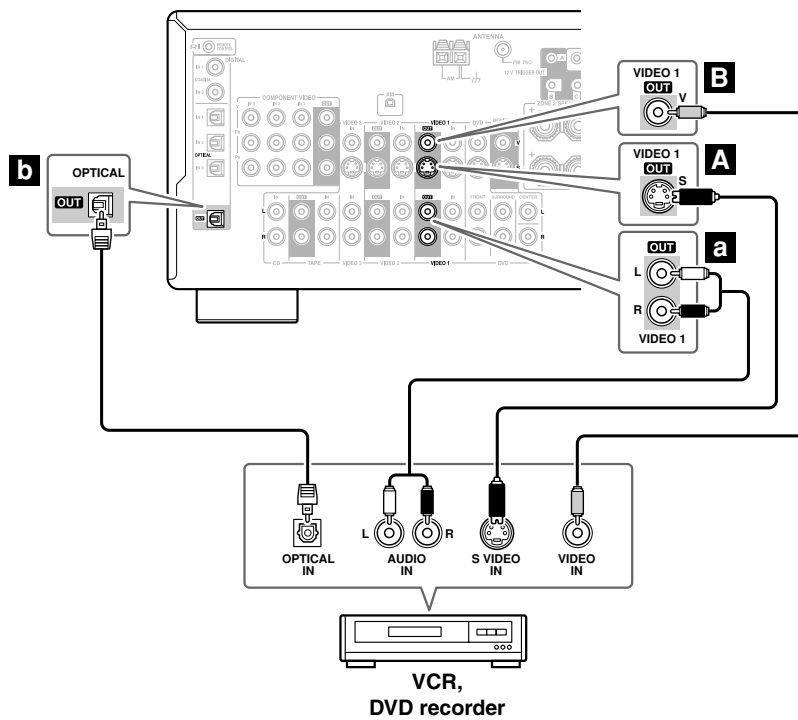

## Connecting Your Components—Continued

### Connecting a Satellite, Cable, Set-top box, or Other Video Source

#### Step 1: Video Connection

Choose a video connection that matches the video source (**A**, **B**, or **C**), and then make the connection. If you use connection **A**, you must connect the AV receiver to your TV with the same type of connection.

#### Step 2: Audio Connection

Choose an audio connection that matches the video source (**a**, **b**, or **c**), and then make the connection.

- With connection **a**, you can listen to and record audio from the video source and listen in Zone 2.
- To enjoy Dolby Digital and DTS, use connection **b** or **c**. (For Zone 2, use **a** and **b**, or **a** and **c**.)

Connection	AV receiver	Signal flow	Video source	Picture quality
<b>A</b>	COMPONENT VIDEO 3 IN	←	Component video output	Best
<b>B</b>	VIDEO 3 IN S	←	S-Video output	Better
<b>C</b>	VIDEO 3 IN V	←	Composite video output	Standard
<b>a</b>	VIDEO 3 IN L/R	←	Analog audio L/R output	
<b>b</b>	DIGITAL COAXIAL IN 2	←	Digital coaxial output	
<b>c</b>	DIGITAL OPTICAL IN 2	←	Digital optical output	

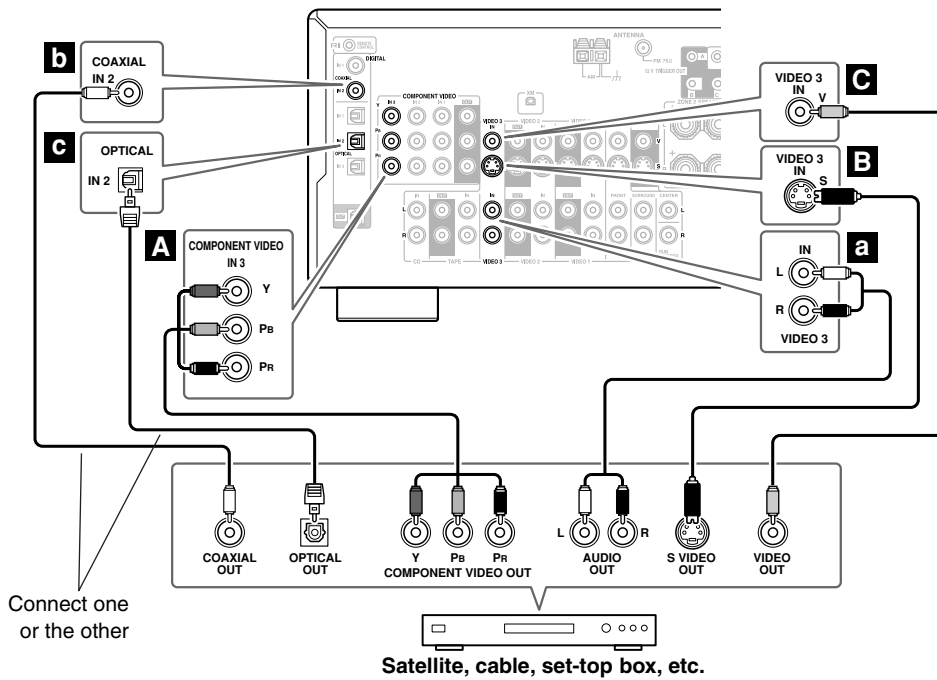

## Connecting Your Components—Continued

### Connecting a CD Player

**Step 1:**

Choose a connection that matches your CD player (**a**, **b**, or **c**), and then make the connection.

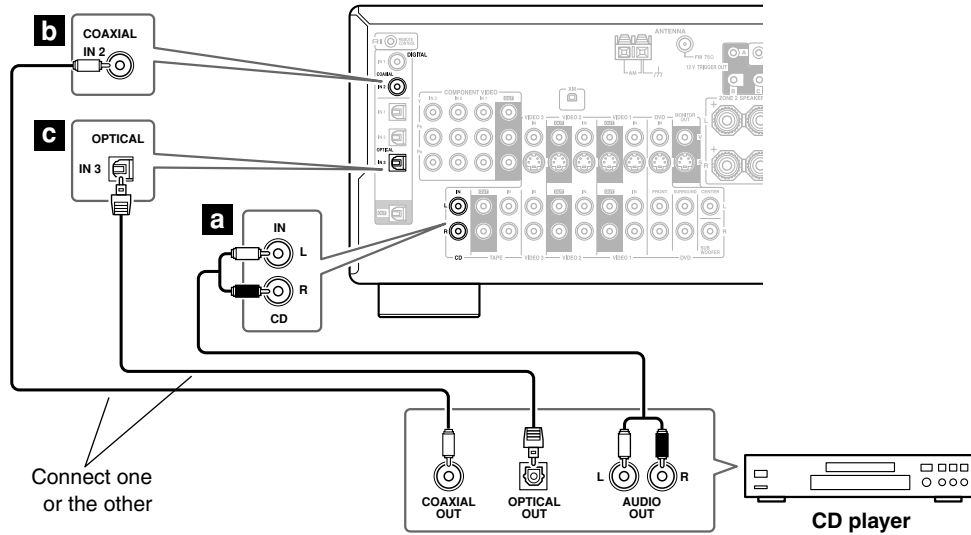

- With connection **a**, you can listen to and record audio from the CD player and listen in Zone 2.
- To connect the CD player digitally, use connection **b** or **c**. (For Zone 2, use **a** and **b**, or **a** and **c**.)

Connection	AV receiver	Signal flow	CD player
<b>a</b>	CD IN L/R	←	Analog audio L/R output
<b>b</b>	DIGITAL COAXIAL IN 2	←	Digital coaxial output
<b>c</b>	DIGITAL OPTICAL IN 3	←	Digital optical output

## Connecting Your Components—Continued

### Connecting a Turntable

#### ■ Turntable with a Built-in Phono Preamp

Use an analog audio cable to connect an unused audio input on the AV receiver to the audio outputs on your turntable, as shown.

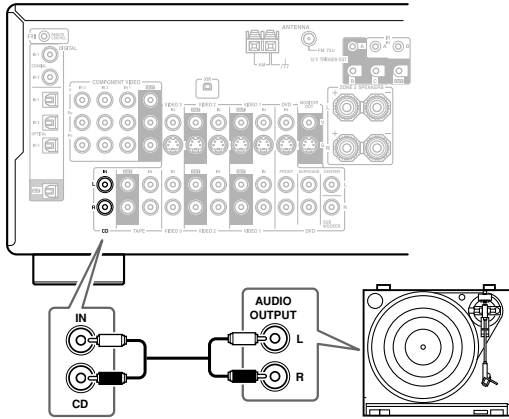

#### ■ Turntable without a Built-in Phono Preamp

Use an analog audio cable to connect an unused audio input on the AV receiver to the audio outputs on your phono preamp, and use another analog audio cable to connect the phono preamp's inputs to your turntable, as shown.

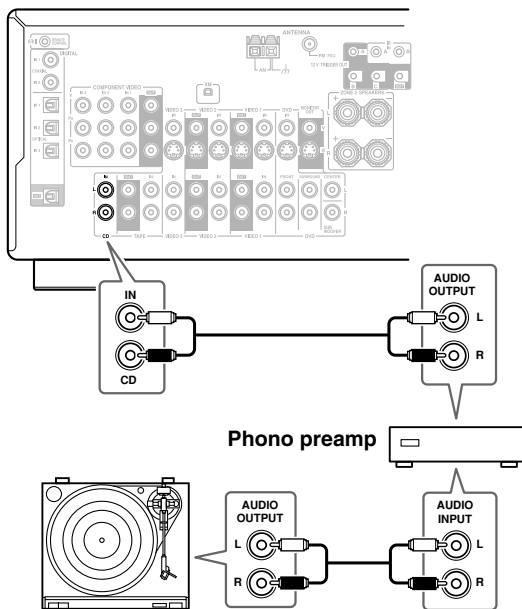

#### ■ Turntable with an MC (Moving Coil) Cartridge

Use an analog audio cable to connect an unused audio input on the AV receiver to the audio outputs on your phono preamp. Use another analog audio cable to connect the phono preamp's inputs to your MC head amp's outputs. And use another analog audio cable to connect the MC head amp's inputs to your turntable, as shown.

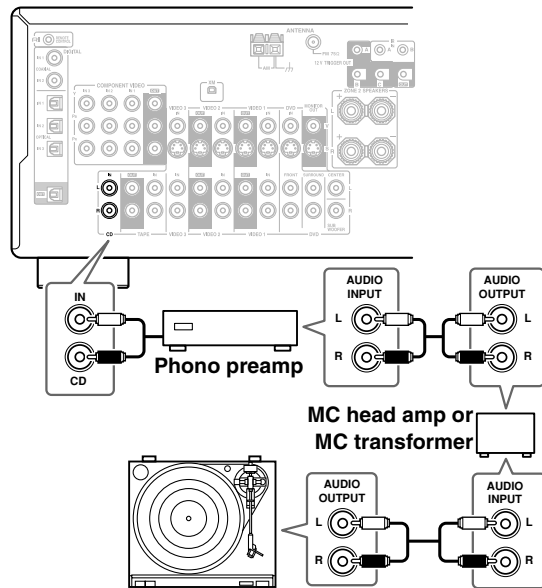

## Connecting Your Components—Continued

### Connecting a Cassette, CDR, MiniDisc, or DAT Recorder

**Step 1:**

Choose a connection that matches the recorder (**a**, **b**, **c**, or **d**), and then make the connection.

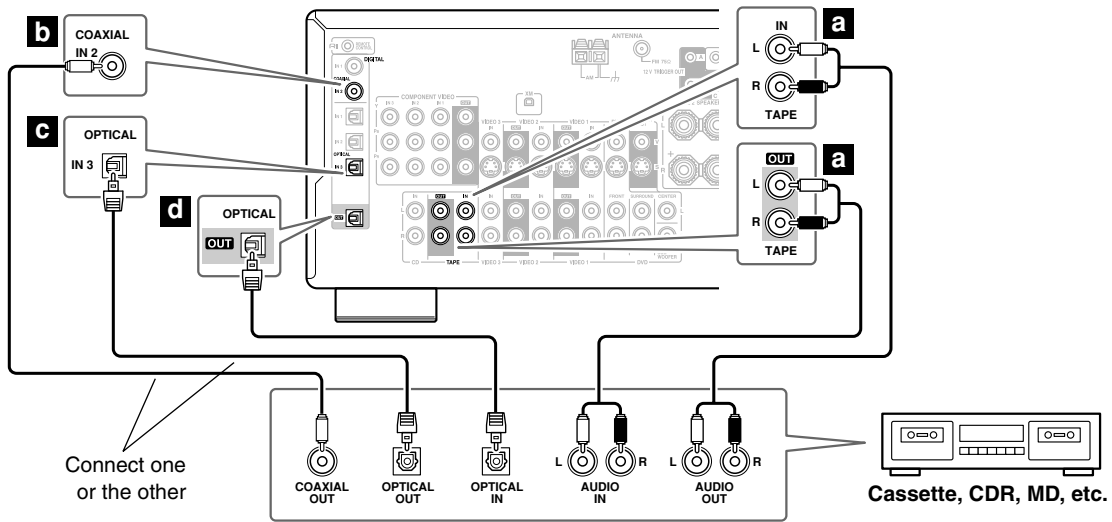

- With connection **a**, you can play and record and listen in Zone 2.
- To connect the recorder digitally for playback, use connections **a** and **b**, or **a** and **c**.
- To connect the recorder digitally for recording, use connection **d**.

Connection	AV receiver	Signal flow	Cassette, CDR, MD, or DAT recorder
<b>a</b>	TAPE IN L/R TAPE OUT L/R	← ⇒	Analog audio L/R output Analog audio L/R input
<b>b</b>	DIGITAL COAXIAL IN 2	←	Digital coaxial output
<b>c</b>	DIGITAL IN OPTICAL IN 3	←	Digital optical output
<b>d</b>	DIGITAL OPTICAL OUT	⇒	Digital optical input



## Connecting Your Components—Continued

### Connecting RI Components

**Step 1:** Make sure that each Integra component is connected to the AV receiver with an analog audio cable (RCA).

**Step 2:** Make the **RI** connection.

With **RI** (Remote Interactive), you can use the following special functions:

#### Auto Power On/Standby

When you start playback on a component connected via **RI**, if the AV receiver is on Standby, it will automatically turn on and select that component as the input source. Similarly, when the AV receiver is set to Standby, all components connected via **RI** will also go on Standby. This function will not work with components connected to an AC OUTLET on the AV receiver.

#### Direct Change

When playback is started on a component connected via **RI**, the AV receiver automatically selects that component as the input source. If your DVD player is connected to the AV receiver's multichannel DVD input, you'll need to press the [Multi CH] button to hear all channels (page 49), as the Direct Change **RI** function only selects the FRONT jacks.

#### Remote Control

You can use the AV receiver's remote controller to control your other **RI**-capable Integra components, pointing the remote controller at the AV receiver's remote control sensor instead of the component. You must enter the appropriate remote control code first (see page 73).

#### Notes:

- Use only **RI** cables for **RI** connections. **RI** cables are supplied with Integra players (DVD, CD, etc.).
- Some components have two **RI** jacks. You can connect either one to the AV receiver. The other jack is for connecting additional **RI**-capable components.
- Connect only Integra components to **RI** jacks. Connecting other manufacturer's components may cause a malfunction.
- Some components may not support all **RI** functions. Refer to the manuals supplied with your other Integra components.
- If you connect an Integra MD recorder, CD recorder, or next generation HDD-compatible component, you must change the input display (see page 41).

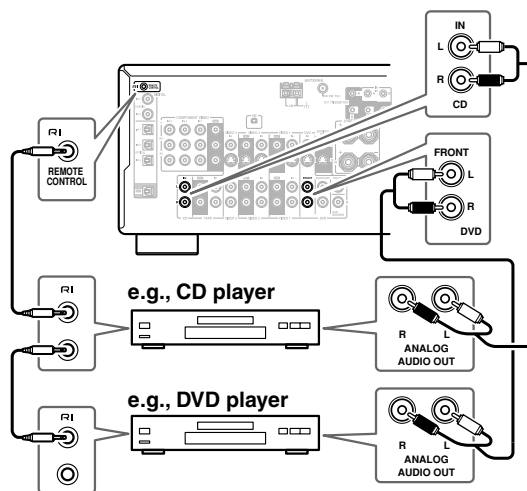

## Connecting Your Components—Continued

### Connecting the Power Cords of Other Components

The AV receiver has AC outlets on its rear panel that can be used to connect the power cords of other components that you intend to use with the AV receiver. These components can then be left turned on so that they turn on and off as when the AV receiver is turned on and set to Standby.

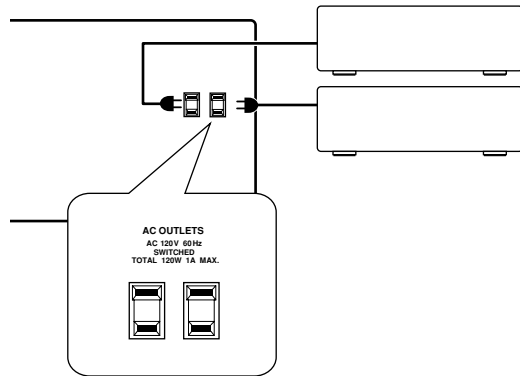

#### Caution:

- Make sure that the total capacity of the components that you connect to the AC OUTLETS does not exceed the stated capacity (e.g., TOTAL 120 W).

#### Note:

- Integra components connected via **RI** should be connected directly to a wall outlet, not an AC OUTLET on the AV receiver.
- The number of AC OUTLETS, socket type, and total capacity depends on the country in which you purchased the AV receiver.

### Connecting the RS232 Port

This port is for connecting the AV receiver to home automation equipment and external controllers.

### Connecting the Power Cord

#### Notes:

- Before connecting the power cord, connect all of your speakers and AV components.
- Turning on the AV receiver may cause a momentary power surge that might interfere with other electrical equipment on the same circuit. If this is a problem, plug the AV receiver into a different branch circuit.
- Do not use a power cord other than the one supplied with the AV receiver. The supplied power cord is designed exclusively for use with the AV receiver and should not be used with any other equipment.
- Never disconnect the power cord from the AV receiver while the other end is still plugged into a wall outlet. Doing so may cause an electric shock. Always disconnect the power cord from the wall outlet first, and then the AV receiver.

- 1 Connect the supplied power cord to the AV receiver's AC INLET.**
- 2 Plug the power cord into an AC wall outlet.** The Standby indicator lights up.

# Turning On the AV Receiver

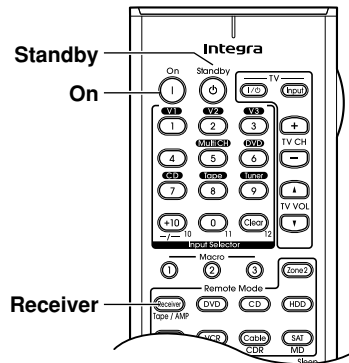
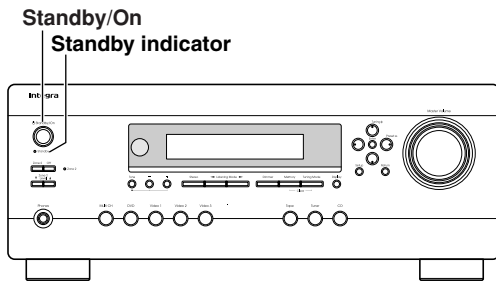

## Turning On and Standby

### AV receiver



or

### Remote controller

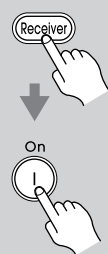

Press the [Standby/On] button.

Alternatively, press the remote controller's [Receiver] button, followed by the [On] button.

The AV receiver comes on, the display lights up, and the Standby indicator goes off. Pressing the remote controller's [On] button again will turn on any components connected via **RI**.

To turn the AV receiver off, press the [Standby/On] button, or press the remote controller's [Standby] button. The AV receiver will enter Standby mode. To prevent any loud surprises when you turn on the AV receiver, always turn down the volume before you turn it off.

## Smooth Operation in a Few Easy Steps

To ensure smooth operation, here's a few easy steps to help you configure the AV receiver before you use it for the very first time. These settings only need to be made once.

### ■ Do the speaker setup—this is essential!

See "Speaker Setup" on page 36.

### ■ Have you connected a component to component video input or digital audio input?

If you have, see "Component Video Setup" on page 39 or "Digital Audio Input Setup" on page 40 respectively.

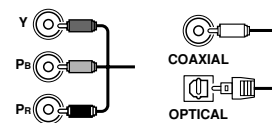

### ■ Have you connected an Integra MD recorder, CD recorder, or next generation HDD-compatible component?

If you have, see "Changing the Input Display" on page 41.

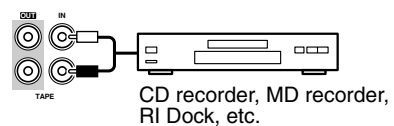

# First Time Setup

This section explains the settings that you need to make before using the AV receiver for the very first time.

## Speaker Setup

This section explains how to set the speaker settings.

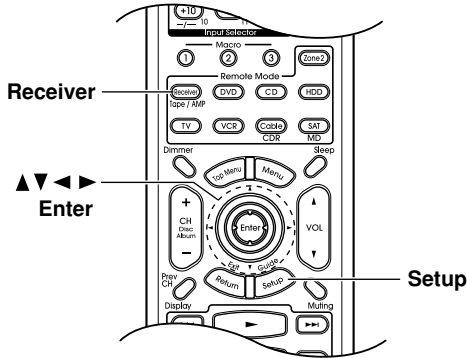

## Speaker Configuration

Here you can specify which speakers are connected and their individual sizes.

For speakers with a cone diameter over 6-1/2 inches (16 cm), specify *large*, and for those with a diameter below this, specify *small*.

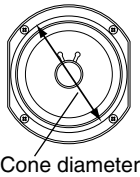

<p><b>1</b></p>	<p><b>Press the [Receiver] Remote Mode button, followed by the [Setup] button.</b> The main menu appears onscreen.</p>
<p><b>2</b></p>	<p><b>Use the Up and Down [▲]/[▼] buttons to select “3. Speaker Setup,” and then press [Enter].</b> The Speaker Setup menu appears.</p>
<p><b>3</b></p>	<p><b>Use the Up and Down [▲]/[▼] buttons to select “Speaker Configuration,” and then press [Enter].</b> The Speaker Config menu appears.</p> <div style="border: 1px solid black; padding: 5px; margin-top: 10px;"> <pre> 3-1. Speaker Config ----- a. Subwoofer      : Yes b. Front         : Small c. Center        : Small d. Surround      : Small e. Crossover     : 100Hz f. Subwoofer Mode : -----                     </pre> </div>

**4**

**Use the Up and Down [▲]/[▼] buttons to select “a. Subwoofer,” and then use the Left and Right [◀]/[▶] buttons to select:**  
**Yes:** Select if a subwoofer is connected.  
**No:** Select if no subwoofer is connected.

**5**

**Use the Up and Down [▲]/[▼] buttons to select “b. Front,” and then use the Left and Right [◀]/[▶] buttons to select:**  
**Small:** Select if the front speakers are small.  
**Large:** Select if the front speakers are large.  
**Note:**  
 • If the Subwoofer setting in step 4 is set to No, this setting is fixed at Large.

**6**

**Use the Up and Down [▲]/[▼] buttons to select “c. Center,” and then use the Left and Right [◀]/[▶] buttons to select:**  
**Small:** Select if the center speaker is small.  
**Large:** Select if the center speaker is large.  
**None:** Select if no center speaker is connected.  
**Note:**  
 • If the Front setting in step 5 is set to Small, the Large option cannot be selected.

**7**

**Use the Up and Down [▲]/[▼] buttons to select “d. Surround,” and then use the Left and Right [◀]/[▶] buttons to select:**  
**Small:** Select if the surround left and right speakers are small.  
**Large:** Select if the surround left and right speakers are large.  
**None:** Select if no surround left and right speakers are connected.  
**Note:**  
 • If the Front setting in step 5 is set to Small, the Large option cannot be selected.

## First Time Setup—Continued

### Crossover

8



Use the Up and Down [▲]/[▼] buttons to select “g. Crossover,” and then use the Left and Right [◀]/[▶] buttons to select a crossover frequency.

Choose a crossover frequency suitable for your setup. If you’re using a subwoofer, choose a crossover frequency based on the diameter of your front speakers. If you’re not using a subwoofer, use the diameter of any speaker that you specified as Small.

Speaker cone diameter	Crossover frequency
Over 8 in. (20 cm)	60Hz 70Hz
6-1/2 to 8 in. (16–20 cm)	80Hz 90Hz
5-1/4 to 6-1/2 in. (13–16 cm)	100Hz 110Hz
3-1/2 to 5-1/4 in. (9–13 cm)	120Hz 130Hz
Under 3-1/2 in. (9 cm)	150Hz 200Hz

Continue with step 9.

#### Note:

- If the crossover frequency is set to a low value, and the program material doesn’t contain any sounds below that frequency, the subwoofer will not output much sound.

### Subwoofer Mode

With this setting, you can boost bass output by feeding front left and right channel bass sounds to the subwoofer. This setting can only be made if the Subwoofer setting in step 4 is set to Yes, and the Front setting in step 5 is set to Large.

9



Use the Up and Down [▲]/[▼] buttons to select “h. Subwoofer Mode,” and then use the Left and Right [◀]/[▶] buttons to select: **LFE only:** The subwoofer only outputs the LFE channel.

**Double Bass:** In addition to LFE channel sounds, the subwoofer outputs front left and right channel bass sounds.

10



Press the [Setup] button.  
Setup closes.

#### Note:

- These procedures can also be performed on the AV receiver by using its [Setup] button, arrow buttons, and [Enter] button.

### Speaker Distance

With these settings, you can specify the distance from each speaker to the listening position.

1

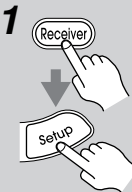

Press the [Receiver] Remote Mode button, followed by the [Setup] button.  
The main menu appears onscreen.

2

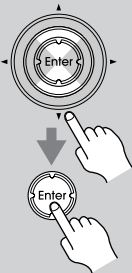

Use the Up and Down [▲]/[▼] buttons to select “3. Speaker Setup,” and then press [Enter].  
The Speaker Setup menu appears.

3

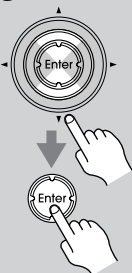

Use the Up and Down [▲]/[▼] buttons to select “Speaker Distance,” and then press [Enter].  
The Speaker Distance menu appears.

#### 3-2. Speaker Distance

```

-----
a. Unit       : feet 00
b. Front     : 12.0ft00
c. Center    : 12.0ft00
d. Surround R : 7.0ft00
e. Surround L : 7.0ft00
f. Subwoofer  : 12.0ft00
  
```

#### Note:

Speakers that you set to No or None on the Speaker Config menu (page 36) cannot be selected.

## First Time Setup—Continued

**4**  Use the Up and Down [▲]/[▼] buttons to select “a. Unit,” and then use the Left and Right [◀]/[▶] buttons to select:

**feet:** Select if you want to enter distances in feet. Can be set from 1 to 30 feet in 0.5-foot steps.

**meters:** Select if you want to enter distances in meters. Can be set from 0.3 to 9 meters in 0.15-meter steps.

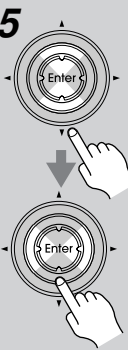
**5**  Use the Up and Down [▲]/[▼] buttons to select each speaker and then use the Left and Right [◀]/[▶] buttons to specify the distance.

Specify the distance from the speaker to your listening position.

**6** Repeat step 5 for all speakers.

**7**  Press the [Setup] button. Setup closes.

**Note:**

- This procedure can also be performed on the AV receiver by using its [Setup] button, arrow buttons, and [Enter] button.

### Speaker Level Calibration

With these settings, you can adjust the level of each speaker while listening to the test tone so that the volume of each speaker is the same at the listening position.

**Note:**

- The speakers cannot be calibrated while the output of the AV receiver is muted or a pair of headphones is connected.

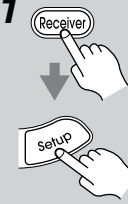
**1**  Press the [Receiver] Remote Mode button, followed by the [Setup] button.

The main menu appears onscreen.

**2**  Use the Up and Down [▲]/[▼] buttons to select “3. Speaker Setup,” and then press [Enter].

The Speaker Setup menu appears.

**3**  Use the Up and Down [▲]/[▼] buttons to select “Level Calibration,” and then press [Enter].

The Level Calibration menu appears and the pink noise test tone is output by the front left speaker.

3-3. Level Calibration	
a. Left	: 0dB
b. Center	: 0dB
c. Right	: 0dB
d. Surround R	: 0dB
e. Surround L	: 0dB
f. Subwoofer	: 0dB

**Note:**  
Speakers that you set to No or None on the Speaker Config menu (page 36) cannot be adjusted.

**4**  Use the Up and Down [▲]/[▼] buttons to select each speaker, and use the Left and Right [◀]/[▶] buttons to set the volume.

The level can be adjusted from -12 to +12 dB in 1 dB steps (-15 to +12 dB for the subwoofer).

**5** Repeat step 4 so that the volume of the test tone from each speaker is the same.

If you're using a handheld sound level meter, adjust the level of each speaker so it reads 75 dB SPL at the listening position, measured with C-weighting and slow reading.

**6**  Press the [Setup] button. Setup closes.

**Note:**

- The speaker levels can also be changed by using the dedicated buttons on the remote controller. Press the [Test Tone] button to output the test tone. Use the [CH Sel] button to select each speaker, and use the [Level-] and [Level+] buttons to adjust the level.

## First Time Setup—Continued

### Component Video Setup

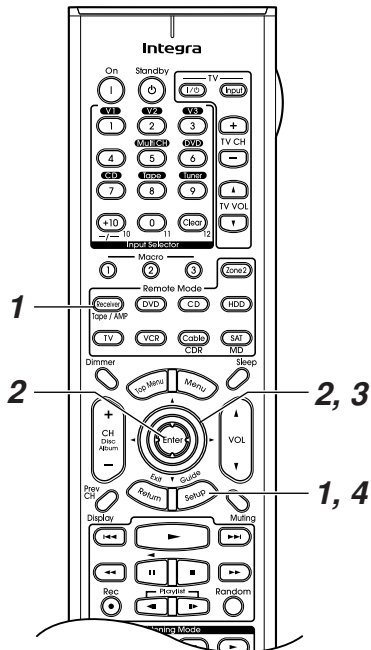

If you connect a video component to COMPONENT VIDEO IN 1, 2, or 3, you must assign that input to an input selector. For example, if you connect your DVD player to COMPONENT IN 3, you must assign COMPONENT IN 3 to the DVD input selector.

To upconvert and output composite video and S-Video sources from the COMPONENT VIDEO OUT, select the VIDEO setting.

Here are the default assignments.

Input selector	Default assignment
DVD	IN1
VIDEO 1	VIDEO
VIDEO 2	VIDEO
VIDEO 3	VIDEO

**1** Press the [Receiver] button, followed by the [Setup] button.  
The main menu appears onscreen.

**2** Use the Up and Down [▲]/[▼] buttons to select "1. Component Video," and then press [Enter].  
The Component Video menu appears.

1.Component Video

-----

a. DVD : IN1

b. VIDEO1 : VIDEO

c. VIDEO2 : VIDEO

d. VIDEO3 : VIDEO

**3** Use the Up and Down [▲]/[▼] buttons to select an input selector, and use the Left and Right [◀]/[▶] buttons to select:

- IN1:** Select if the video component is connected to COMPONENT VIDEO IN 1.
- IN2:** Select if the video component is connected to COMPONENT VIDEO IN 2.
- IN3:** Select if the video component is connected to COMPONENT VIDEO IN 3.
- VIDEO:** Select to output composite video and S-Video sources from the COMPONENT VIDEO OUT.

**4** Press the [Setup] button.  
Setup closes.

**Note:**

- This procedure can also be performed on the AV receiver by using its [Setup] button, arrow buttons, and [Enter] button.

## First Time Setup—Continued

### Digital Audio Input Setup

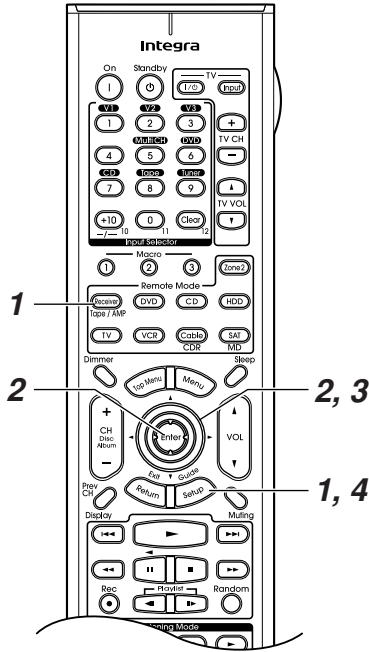

If you connect a component to a digital input, you must assign that input to an input selector. For example, if you connect your CD player to OPTICAL IN 2, you must assign OPTICAL IN 2 to the CD input selector.

Here are the default assignments.

Input selector	Default assignment
DVD	Coax 1
VIDEO 1	Opt 1
VIDEO 2	No
VIDEO 3	Opt 2
TAPE	No
CD	Opt 3

**1** Press the [Receiver] button, followed by the [Setup] button. The main menu appears onscreen.

**2** Use the Up and Down [▲]/[▼] buttons to select "2. Digital Input," and then press [Enter]. The Digital Input menu appears.

```

2. Digital Input
-----
a. DVD           : Coax1 
b. VIDEO01      : Opt1  
c. VIDEO02      : No    
d. VIDEO03      : Opt2  
e. TAPE         : No    
f. CD           : Opt3  
    
```

**3** Use the Up and Down [▲]/[▼] buttons to select an input selector, and then use the Left and Right [◀]/[▶] buttons to select: Coax 1, Coax 2, Opt 1, Opt 2, Opt 3, or No (analog).

For input selectors that you want to use with an analog input, select No.

- Inputs cannot be assigned to the Tuner input selector.

**4** Press the [Setup] button. Setup closes.

**Note:**

- This procedure can also be performed on the AV receiver by using its [Setup] button, arrow buttons, and [Enter] button.



## First Time Setup—Continued

### Changing the Input Display

If you connect an **RI**-capable Integra MiniDisc recorder, CD recorder, or next generation HDD-compatible component to the TAPE IN/OUT or VIDEO 3 IN jacks, for **RI** to work properly, you must change this setting.

This setting can only be changed on the AV receiver.

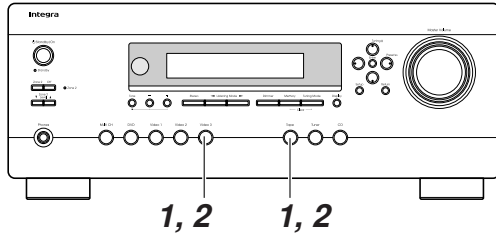

<p><b>1</b></p> <p>Tape or Video 3</p> <p>or</p>	<p><b>Press the [Tape] or [Video 3] input selector button so that "TAPE" or "VIDEO3" appears on the display.</b></p> <div style="border: 1px solid black; padding: 2px; margin-bottom: 5px;">TAPE</div> <div style="border: 1px solid black; padding: 2px;">VIDEO3</div>
<p><b>2</b></p> <p>Tape or Video 3</p> <p>or</p>	<p><b>Press and hold down the [Tape] or [Video 3] input selector button (about 3 seconds) to change the setting.</b></p> <p>Repeat this step to select MD, CDR, or HDD.</p> <p>For the Tape input selector, the setting changes in this order:</p> <div style="border: 1px solid black; padding: 2px; display: inline-block;">             → TAPE → MD → CDR → HDD         </div> <p>For the Video 3 input selector, the setting changes in this order:</p> <p>VIDEO 3 ↔ HDD</p>

**Note:**  
HDD can be selected for the Tape input selector or Video 3 input selector, but not both at the same time.

# Playing Your AV Components

## Basic AV Receiver Operation

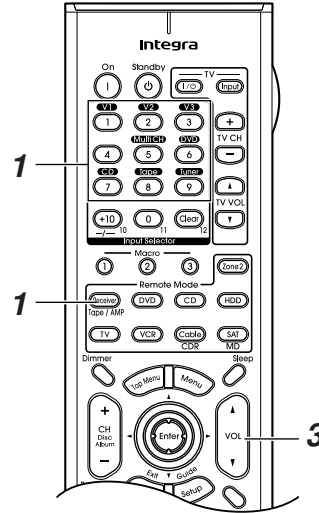
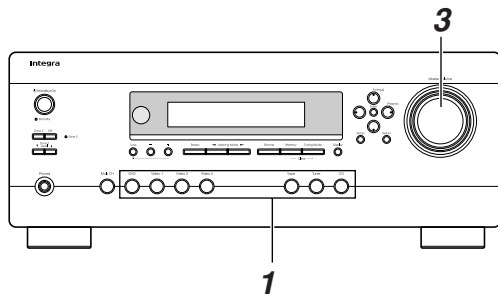

<p><b>1</b></p> <p><b>AV receiver</b></p> <p><b>Remote controller</b></p>	<p><b>Use the AV receiver's input selector buttons to select the input source.</b></p> <p><b>To select the input source with the remote controller, press the [Receiver] Remote Mode button, and then use the Input Selector buttons.</b></p> <p>On the remote controller, the [V1], [V2], and [V3] buttons select the Video 1, Video 2, and Video 3 input sources respectively.</p>
<p><b>2</b></p>	<p><b>Start playback on the source component.</b></p> <p>To watch a DVD or other video source, on your TV, select the video input that's connected to the AV receiver's COMPONENT VIDEO OUT, or MONITOR OUT.</p> <p>On some DVD players, you may need to change the digital setting.</p>
<p><b>3</b></p> <p><b>AV receiver</b></p> <p><b>Remote controller</b></p>	<p><b>To adjust the volume, use the Master Volume control or the remote controller's [VOL] button.</b></p> <p>Since the AV receiver is designed for home theaters, it has a wide volume range for precise adjustment. The volume can be set to <math>-\infty</math> dB, <math>-81</math> dB, <math>-80</math> dB through <math>+18</math> dB.</p>
<p><b>4</b></p>	<p><b>Select a listening mode and enjoy!</b></p> <p>See "Using the Listening Modes" on page 52.</p>

# Listening to the Radio

## Listening to AM/FM Stations

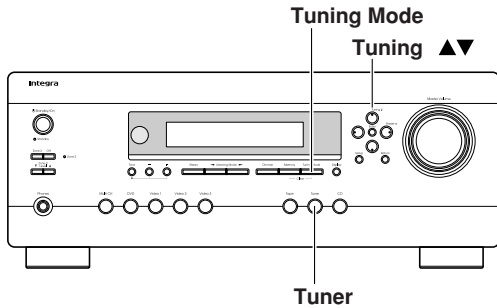

With the built-in tuner, you can enjoy AM and FM radio stations, and store your favorite stations as presets for easy selection.

**1** Tuner

Use the [Tuner] input selector button to select AM or FM. In this example, FM has been selected.

FM 87.5 MHz

Band      Frequency

(Actual display depends on country.)

## Tuning into AM/FM Radio Stations

### Auto Tuning Mode

**1** Tuning Mode

Press the [Tuning Mode] button so that the AUTO indicator appears on the display.

**2** Tuning ▲▼

Press the Tuning Up or Down [▲]/[▼] button. Searching stops when a station is found.

When tuned into a station, the TUNED indicator appears. When tuned into a stereo FM station, the FM STEREO indicator also appears.

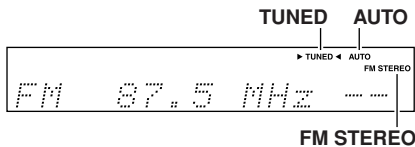

### Manual Tuning Mode

**1** Tuning Mode

Press the [Tuning Mode] button so that the AUTO indicator disappears from the display.

**2** Tuning ▲▼

Press and hold the Tuning Up or Down [▲]/[▼] button. The frequency stops changing when you release the button. Press the buttons repeatedly to change the frequency one step at a time.

The American model changes FM frequency in 0.2 MHz steps, 10 kHz steps for AM. For other models it's 0.05 MHz steps for FM and 9 kHz steps for AM. In Manual Tuning mode, FM stations will be in mono.

### Tuning into Weak FM Stereo Stations

If the signal from a stereo FM station is weak, it may be impossible to get good reception. In this case, switch to Manual Tuning mode and listen to the station in mono.

## Displaying AM/FM Radio Information

**1** Display

Press the [Display] button repeatedly to cycle through the available information.

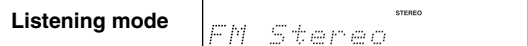

## Listening to the Radio—Continued

### Listening to XM Satellite Radio®

#### What's XM Satellite Radio?

There is a world beyond AM and FM. It is XM Satellite Radio. XM offers more than 150 digital channels of audio entertainment, including 100% commercial-free music channels, in the top markets in the U.S.

*Note: An XM Connect-and-Play™ antenna and monthly subscription are required to receive XM Satellite Radio. Visit [www.xmradio.com](http://www.xmradio.com) for details.*

#### Note:

Hardware and required basic monthly subscription sold separately. Premium Channels available at additional monthly cost. Installation costs and other fees and taxes, including a one-time activation fee may apply. Subscription fee is consumer only. All fees and programming subject to change. Channels with frequent explicit language are indicated with an XL. Channel blocking is available for XM radio receivers by calling 1-800-XMRADIO. Subscriptions subject to Customer Agreement available at [xmradio.com](http://xmradio.com). Only available in the 48 contiguous United States.

#### A warning against reverse engineering:

It is prohibited to copy, decompile, disassemble, reverse engineer, or manipulate any technology incorporated in receivers compatible with the XM Satellite Radio system. Furthermore, the AMBE® voice compression software included in this product is protected by intellectual property rights including patent rights, copyrights, and trade secrets of Digital Voice Systems, Inc. The user of this or any other software contained in an XM Radio is explicitly prohibited from attempting to copy, decompile, reverse engineer, or disassemble the object code, or in any other way convert the object code into human-readable form. The software is licensed solely for use within this product.

### Connecting the XM Antenna

The XM antenna is sold separately. You can purchase the XM Connect-and-Play antenna from the XM Web site at: <http://www.xmradio.com>

Connect the Connect-and-Play antenna to the XM antenna jack on the rear panel.

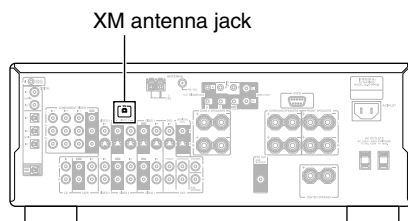

Put the XM antenna by a southerly facing window, with nothing obstructing its path to the sky.

### Signing Up for XM Satellite Radio

Before you can use XM Satellite Radio, you must first sign up for an account. You'll need a major credit card and your XM Satellite Radio ID, which you can get from the AV receiver, as explained below, or from the Connect-and-Play package and itself.

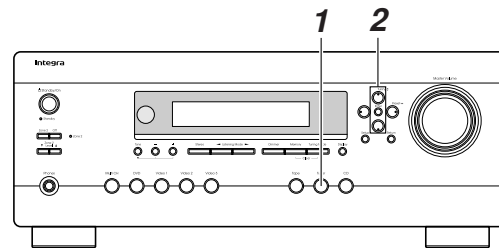

**1**

Tuner



**Press the [Tuner] input selector button repeatedly to select XM.**

If "CHECK ANTENNA" appears on the display, make sure the XM antenna is connected properly.

**2**

Tuning ↑



**Use the Tuning Up and Down [▲]/[▼] buttons to select channel 0.**

Your XM Satellite Radio ID number is displayed. Write it below.

ID \_\_\_\_\_

**3**

**To sign up, go to:  
<http://activate.xmradio.com>  
Or call: 1-800-967-2346**

#### Notes:

- Channel 0 cannot be selected in Category Search mode. You must select Channel Search mode (see page 45).
- The following letters are not used in XM Satellite Radio IDs: I, O, S, F.

## Listening to the Radio—Continued

### Selecting XM Radio Channels

There are two modes for selecting XM radio channels: **Channel Search mode**, which allows you to select any channel.

**Category Search mode**, which allows you to select channels by category.

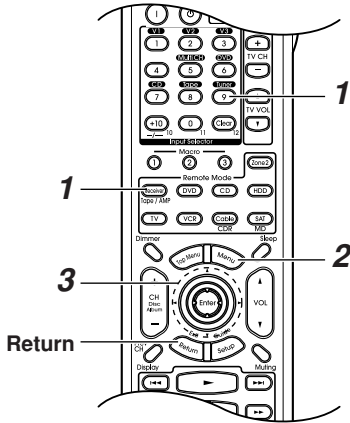

### Category Search Mode

<b>1</b>	<p>Press the [Receiver] Remote Mode button, and then press the [Tuner] Input Selector button repeatedly to select XM.</p> <p>If “CHECK ANTENNA” appears on the display, make sure the XM antenna is connected properly.</p>
<b>2</b>	<p>Press the [Menu] button to select “Category Search” mode.</p> <div style="border: 1px solid black; padding: 2px; text-align: center; font-family: monospace;">CategorySearch</div>
<b>3</b>	<p>Use the Left and Right [◀]/[▶] buttons to select a category, and use the Up and Down [▲]/[▼] buttons to select a channel in that category.</p>

**Note:**  
Channels cannot be selected while the ▶ ◀ indicator is flashing, as tuning is in progress.

**Selecting the Previous Channel:**  
To listen to the previously selected XM channel.

<b>1</b>	<p>Press the [Receiver] Remote Mode button, followed by the [Return] button.</p> <p>You can also use the AV receiver’s [Return] button.</p>
----------	---------------------------------------------------------------------------------------------------------------------------------------------

### Channel Search Mode

<b>1</b>	<p>Press the [Receiver] Remote Mode button, and then press the [Tuner] Input Selector button repeatedly to select XM.</p> <p>If “CHECK ANTENNA” appears on the display, make sure the XM antenna is connected properly.</p>
<b>2</b>	<p>Press the [Menu] button to select “Channel Search” mode.</p> <div style="border: 1px solid black; padding: 2px; text-align: center; font-family: monospace;">ChannelSearch</div>
<b>3</b>	<p>Use the Up and Down [▲]/[▼] buttons to select a channel.</p> <div style="border: 1px solid black; padding: 2px; text-align: center; font-family: monospace;">050 The Loft</div> <p style="text-align: center;">Channel number    Channel name</p> <p>You can also use the Left and Right [◀]/[▶] buttons to select a category.</p>

**Note:**  
Channels cannot be selected while the ▶ ◀ indicator is flashing, as tuning is in progress.

## Listening to the Radio—Continued

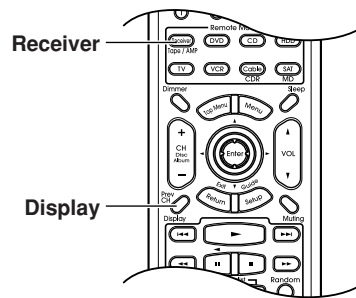
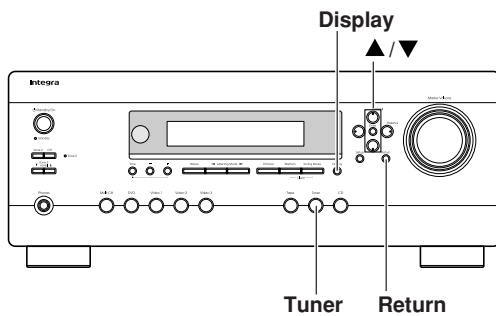

### Selecting XM Channels from the Front Panel:

<b>1</b> 	<p><b>Press the [Tuner] input selector button repeatedly to select XM.</b> If “CHECK ANTENNA” appears on the display, make sure the XM antenna is connected properly.</p>
<b>2</b> 	<p><b>Use the Tuning Up and Down [▲]/[▼] buttons to select a channel.</b> In Channel Search mode, you can select any channel. In Category Search mode, you can only select channels from the currently selected category.</p>

The following information can be displayed:

Channel name	XM The Loft
Channel number & preset number	XM 050 5
Category	CAT >Rock
Artist	NAME>Coldplay
Song title	TITL>Clocks
Listening mode	XM Stereo

### Displaying XM Radio Information

<b>1</b> 	<p><b>On the AV receiver, press the [Display] button repeatedly to cycle through the available information.</b></p>
	<p><b>On the remote controller, press the [Receiver] Remote Mode button, and then press the [Display] button repeatedly.</b></p>

**Note:**

If the category, artist, or song title is not available, “- - -” will be displayed instead.

■ **Displaying XM Information on Your TV**

When you select a different XM channel, or the artist or song title changes, the following information is displayed on your TV for 5 seconds.

XM	[Category name]	
	[Channel name]	[Ch. No]
	[Artist name / Song Title]	

**Tip:**

You can display this information at anytime by pressing the [Display] button.

## Listening to the Radio—Continued

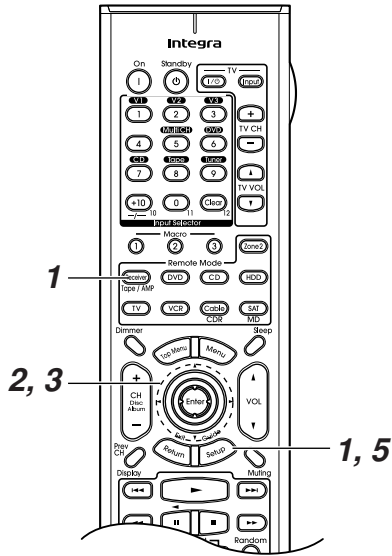

### Positioning the XM Antenna

You can check the signal strength of the XM radio signal and adjust the position of the XM antenna accordingly.

<p><b>1</b></p>	<p><b>Press the remote controller's [Receiver] button, followed by the [Setup] button.</b></p>
<p><b>2</b></p>	<p><b>Use the Up and Down [▲]/[▼] buttons to select "4. Input Setup," and then press [Enter].</b></p>
<p><b>3</b></p>	<p><b>Use the Up and Down [▲]/[▼] buttons to select "2. XM Antenna Aiming," and then press [Enter].</b></p> <div style="border: 1px solid black; padding: 5px; margin-top: 10px;"> <p>4. Input Setup -----TUNER----- 1. Delay 2. XM Antenna Aiming</p> </div>

**4** Adjust the position of the XM antenna so that the "Signal Quality" is at least 70%.

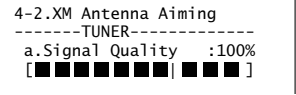

The signal quality range is 0% to 100%.

**5** When you've finished, press the [Setup] button. Setup closes.

**Note:**  
If the signal quality is 0%, make sure that the XM antenna is connected properly.

### XM Radio Messages

The following messages may appear while using XM radio.



The XM antenna is not connected properly. Check the antenna.



The XM user encryption code is being updated. Please wait.



The signal is too weak. Check the antenna connection and reposition it for the best reception.



The AV receiver is tuning or decoding audio or text data. Please wait.



The XM channel you selected is not currently broadcasting. Select another channel.

## Listening to the Radio—Continued

### Presetting AM/FM Stations and XM Channels

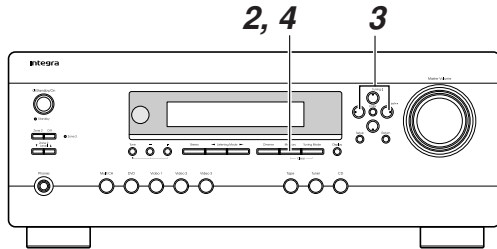

You can store a combination of up to 40 of your favorite AM/FM radio stations and XM channels as presets.

- |          |                                                                                                                                                                                                                                                    |
|----------|----------------------------------------------------------------------------------------------------------------------------------------------------------------------------------------------------------------------------------------------------|
| <b>1</b> | <p><b>Tune into the AM/FM station or XM channel that you want to store as a preset.</b></p>                                                                                                                                                        |
| <b>2</b> | <p><b>Press the [Memory] button.</b><br/>The MEMORY indicator appears and the preset number flashes.</p>                                                                                                                                           |
| <b>3</b> | <p><b>While the MEMORY indicator is displayed (about 8 seconds), use the Preset [◀]/[▶] buttons to select a preset from 1 through 40.</b></p>                                                                                                      |
| <b>4</b> | <p><b>Press the [Memory] button again to store the station or channel.</b><br/>The station or channel is stored and the preset number stops flashing.<br/>Repeat this procedure for all of your favorite AM/FM radio stations and XM channels.</p> |

### Selecting Presets

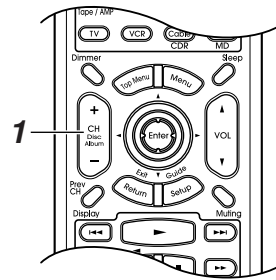
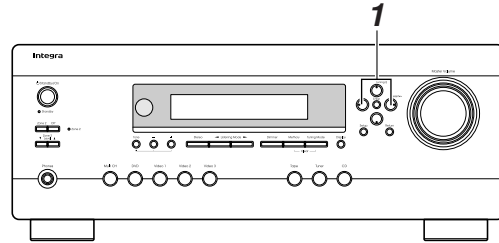

- |          |                                                                                                               |
|----------|---------------------------------------------------------------------------------------------------------------|
| <b>1</b> | <p><b>To select a preset, use the Preset [◀]/[▶] buttons, or the remote controller's CH [+/-] button.</b></p> |
|----------|---------------------------------------------------------------------------------------------------------------|

### Deleting Presets

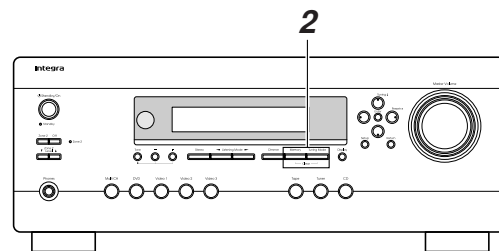

- |          |                                                                                                                                                             |
|----------|-------------------------------------------------------------------------------------------------------------------------------------------------------------|
| <b>1</b> | <p><b>Select the preset that you want to delete.</b><br/>See the previous section.</p>                                                                      |
| <b>2</b> | <p><b>While holding down the [Memory] button, press the [Tuning Mode] button.</b><br/>The preset is deleted and its number disappears from the display.</p> |



# Using the Multichannel DVD Input

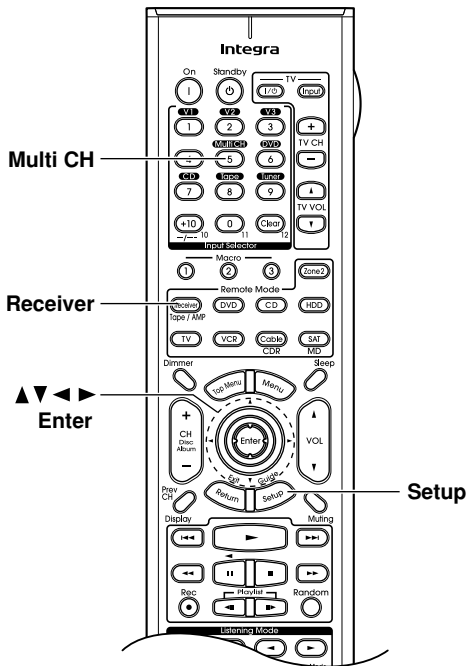

## Using the Multichannel DVD Input

The multichannel DVD input is for connecting a component with a 5.1-channel analog audio output, such as a DVD player, DVD-Audio/SACD-capable player, or an MPEG decoder. See page 26 for hookup information.

**Press the [Receiver] Remote Mode button, followed by the [Multi CH] button.**

The MULTI CH indicator appears on the display.

Audio from the multichannel DVD input will now be used for the DVD input source.

MULTI CH indicator

**Note:**

- While the multichannel DVD input is selected, the Speaker Configuration settings on page 36 are ignored, and signals from the multichannel DVD input are fed to the subwoofer, front left, front right, center, surround left, surround right speakers as they are.

## Multichannel DVD Input Settings

**1**

While the DVD input is selected, press the [Receiver] Remote Mode button, followed by the [Setup] button. The main menu appears onscreen.

**2**

Use the Up and Down [▲]/[▼] buttons to select "4. Input Setup," and then press [Enter].

Use the Up and Down [▲]/[▼] buttons to select "MULTICH," and then press [Enter]. The MULTICH menu appears.

4-2. MULTICH  
-----DVD-----  
b.Subwoofer Sensitivity : 0dB

**3**

Use the Up and Down [▲]/[▼] buttons to select the settings, and use the Left and Right [◀]/[▶] buttons to change them. The settings are explained below.

**4**

Press the [Setup] button. Setup closes.

## Subwoofer Sensitivity

Some DVD players output the LFE channel from their subwoofer output at 15 dB higher than normal. You can change the subwoofer sensitivity to match your DVD player. Note that this setting only affects signals connected to the SUBWOOFER input jack of the multichannel DVD input.

You can select 0 dB, +5 dB, +10 dB, or +15 dB.

If you find that your subwoofer is too loud, try the +10 dB or +15 dB setting.

# Common Functions

This section explains functions that can be used with any input source.

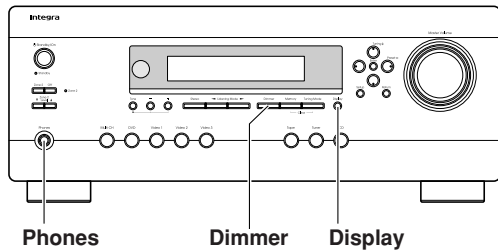
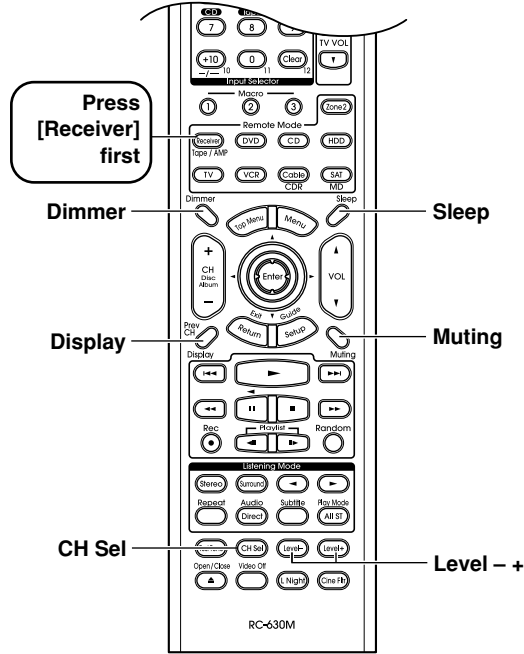

## Setting the Display Brightness

You can adjust the brightness of the display.

**Remote controller**

Dimmer

**Press the [Dimmer] button repeatedly to select: Normal, Dim, Dimmer.**

**AV receiver**

Dimmer

## Adjusting Speaker Levels

You can adjust the volume of each speaker while listening to an input source. These temporary adjustments are cancelled when the AV receiver is set to Standby.

**1** Use the remote controller's [CH Sel] button to select each speaker, and use the [Level-] and [Level+] buttons to adjust the volume.

You can adjust the volume of each speaker from -12 dB to +12 dB (-15 dB to +12 dB for the subwoofer).

Left # 0.0

### Notes:

- You cannot use this function while the AV receiver is muted.
- Speakers that are set to No or None in the Speaker Configuration cannot be adjusted.

### Headphones

While a pair of headphones is connected, you can adjust the volume of each headphone speaker, from -12 dB to +12 dB each.

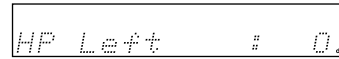

- These settings are stored when the AV receiver is set to Standby.

## Muting the AV Receiver

You can temporarily mute the output of the AV receiver.

Press the remote controller's [Muting] button.

The output is muted and the MUTING indicator flashes on the display.

Muting

MUTING

To unmute the AV receiver, press the remote controller's [Muting] button again, or adjust the volume. The output is unmuted and the MUTING indicator goes off. Muting is cancelled when the AV receiver is set to Standby.

### Tip:

You can choose how much the output is muted by using the Muting Level preference (see page 62).

## Common Functions—Continued

### Using the Sleep Timer

With the sleep timer, you can set the AV receiver so that it turns off automatically after a specified period.



**Press the remote controller's [Sleep] button repeatedly to select the required sleep time.**

You can set the sleep time from 90 to 10 minutes in 10 minute steps.

The SLEEP indicator appears on the display when the sleep timer has been set, as shown. The specified sleep time appears on the display for about 5 seconds, then the previous display reappears.

SLEEP indicator

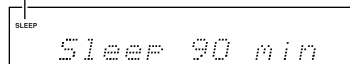

**To cancel the sleep timer,** press the [Sleep] button repeatedly until the SLEEP indicator disappears.

**To check the remaining sleep time,** press the [Sleep] button. Note that if you press the [Sleep] button while the sleep time is being displayed, you'll shorten the sleep time by 10 minutes.

### Using Headphones

For private listening, you can connect a pair of stereo headphones (1/4-inch phone plug) to the AV receiver's Phones jack.

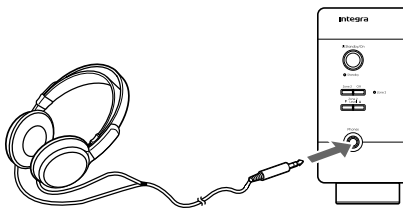

#### Notes:

- Always turn down the volume before connecting your headphones.
- The speakers are turned off while the headphones plug is inserted in the Phones jack. (The Zone 2 speakers are unaffected.)
- When you connect a pair of headphones, the listening mode is set to Stereo, unless it was set to Mono, Stereo, or Direct, in which case it stays the same.

### Displaying Source Information

You can display various information about the current input source as follows.

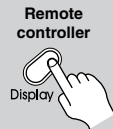

**Press the [Display] button repeatedly to cycle through the available information.**



The following information can typically be displayed:

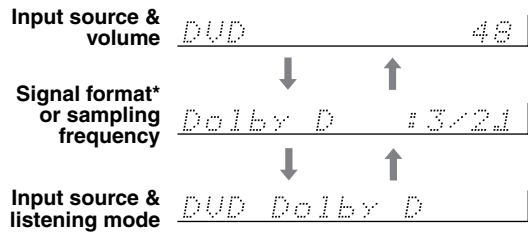

\*If the input signal is analog, no format information is displayed. If the input signal is PCM, the sampling frequency is displayed. If the input signal is digital but not PCM, the signal format is displayed.

#### Interpreting Surround Channel Information

$$\frac{3}{A} \frac{2}{B} \frac{1}{C}$$

- A: The number of front channels (front left, front right, and center).
- B: The number of surround channels (surround left and surround right).
- C: LFE channel for subwoofer (1 means yes).

# Using the Listening Modes

## Selecting the Listening Modes

For a description of each listening mode, see “About the Listening Modes” on page 54.

- The Dolby Digital and DTS listening modes can only be selected if your DVD player is connected to the AV receiver with a digital audio connection (coaxial or optical).
- Listening mode availability depends on the format of the current input signal.
- While a pair of headphones is connected, you can only select the Mono, Direct, or Stereo listening mode.

## Selecting on the AV Receiver

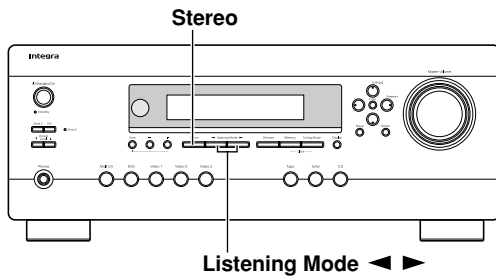

- **[Stereo] button**  
This button selects the Stereo listening mode.
- **Listening Mode [◀/▶] buttons**  
Pressing these buttons repeatedly cycles through all of the listening modes that can be used with the current input source.

## Selecting with the Remote Controller

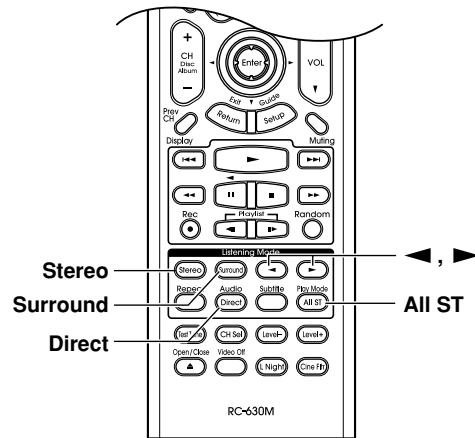

- **[Stereo] button**  
This button selects the Stereo listening mode.
- **[Surround] button**  
This button selects the Dolby Digital and DTS listening modes.
- **Listening Mode [◀/▶] buttons**  
Pressing these buttons repeatedly cycles through all of the listening modes that can be used with the current input source.
- **[Direct] button**  
This button selects the Direct listening mode.
- **[All ST] button**  
This button selects the All Channel Stereo listening mode.

## Using the Listening Modes—Continued

The following table shows which listening modes can be used with each input signal format.

Listening mode	Source format		Dolby Digital				DTS/DTS 96/24 <sup>*2</sup>		Multich analog
	Analog, PCM <sup>*1</sup>		3/2.1 2/2.1	2/0	1/0, 1+1	Other	3/2.1 2/2.1	2/0	
	CD, TV, radio, cassette, etc.		DVD, DTV, etc.				DVD, CD, etc.		DVD
Direct Stereo	✓		✓	✓	✓	✓	✓	✓	✓
Mono	✓		✓	✓	✓	✓	✓	✓	
Multich									✓
PLII Movie/Music/Game Neo:6 Cinema Neo:6 Music <sup>*3</sup>	✓			✓				✓	
Dolby D			✓			✓			
DTS, DTS 96/24							✓		
Onkyo Original DSP Mono Movie Orchestra Unplugged Studio-Mix TV Logic All Ch Stereo Full Mono	✓		✓	✓	✓	✓	✓	✓	

\*1. In the Direct listening mode, 32 kHz, 44.1 kHz, and 48 kHz PCM is processed at 64 kHz, 88.2 kHz, and 96 kHz respectively. In listening modes other than Direct and Stereo, 96 kHz PCM is processed at 48 kHz.

\*2. In listening modes other than Direct, Stereo, and DTS 96/24, DTS 96/24 sources are processed as normal DTS.

\*3. Available only when surround speakers are connected.

**Tip:** To check the format of the digital input signal, see “Displaying Source Information” on page 51.

## Using the Listening Modes—Continued

### About the Listening Modes

The AV receiver's listening modes can transform your listening room into a movie theater or concert hall, with high fidelity and stunning surround sound.

#### Direct

In this mode, audio from the input source is output directly with minimal processing, providing high-fidelity reproduction. All of the source's audio channels are output as they are.

#### Stereo

Sound is output by the front left and right speakers.

#### Mono

Use this mode when watching an old movie with a mono soundtrack, or use it with the foreign language soundtracks recorded in the left and right channels of some movies. It can also be used with DVDs or other sources containing multiplexed audio, such as karaoke DVDs.

#### Dolby Pro Logic II

This mode expands any 2-channel source for 5.1-channel playback. It provides a very natural and seamless surround-sound experience that fully envelops the listener. As well as music and movies, video games can also benefit from the dramatic spatial effects and vivid imaging.

- **PLII Movie**  
Use this mode with any stereo or TV, DVD, VHS.
- **PLII Music**  
Use this mode with any stereo or Dolby Surround (Pro Logic) music source (e.g., CD, radio, cassette, TV, VHS, DVD).
- **PLII Game**  
Use this mode with video games, especially those that bear the Dolby Pro Logic II logo.

#### Dolby Digital

Use this mode with DVDs that bear the  Dolby Digital logo and Dolby Digital TV broadcasts. This is the most common digital surround-sound format, and it'll put you right in the middle of the action, just like being in a movie theater or concert hall.

#### DTS

The DTS digital surround-sound format supports up to 5.1 discrete channels and uses less compression for high-fidelity reproduction. Use it with DVDs and CDs that bear the  DTS logo.

#### DTS 96/24

This mode is for use with DTS 96/24 sources. This is high-resolution DTS with a  96 kHz sampling rate and 24-bit resolution, providing superior fidelity. Use it with DVDs that bear the DTS 96/24 logo.

#### DTS NEO:6

This mode expands any 2-channel source for 5.1-channel playback. It uses five full-bandwidth channels of matrix decoding for matrix-encoded material, providing a very natural and seamless surround sound experience that fully envelops the listener.

- **NEO:6 Cinema**  
Use this mode with any stereo movie (e.g., TV, DVD, VHS).
- **NEO:6 Music**  
Use this mode with any stereo music source (e.g., CD, radio, cassette, TV, VHS, DVD).

### Onkyo Original DSP Modes

#### Mono Movie

This mode is suitable for old movies and other mono sources. The center speaker outputs the sound as it is, while reverb is applied to the sound output by the other speakers, giving presence to even mono material.

#### Orchestra

Suitable for classical or operatic music, this mode emphasizes the surround channels in order to widen the stereo image and simulates the natural reverberation of a large hall.

#### Unplugged

Suitable for acoustic instruments, vocals, and jazz, this mode emphasizes the front stereo image, giving the impression of being right in front of the stage.

#### Studio-Mix

Suitable for rock or pop music, listening to music in this mode creates a lively sound field with a powerful acoustic image, like being at a club or rock concert.

#### TV Logic

This mode adds realistic acoustics to TV shows produced in a TV studio, surround effects to the entire sound, and clarity to voices.

#### All Ch Stereo

Ideal for background music, this mode fills the entire listening area with stereo sound from the front, and surround speakers.

#### Full Mono

In this mode, all speakers output the same sound in mono, so the sound you hear is the same regardless of where you are within the listening room.

# Recording

This section explains how to record the input source and how to record audio and video from separate sources.

## Notes:

- The surround sound and DSP listening modes cannot be recorded.
- Copy-protected DVDs cannot be recorded.
- Sources connected to the multichannel DVD input cannot be recorded.
- Various restrictions apply to digital recording. Refer to the manuals supplied with your digital recording equipment for more details.
- Digital input signals are output by only the digital outputs, and analog input signals are output by only the analog outputs. There is no internal conversion from digital to analog or vice versa.
- DTS signals will be recorded as noise, so don't attempt analog recording of DTS CDs or LDs.

## Recording the Input Source

Audio sources can be recorded to a recorder (e.g., cassette deck, CDR, MD) connected to the TAPE OUT or DIGITAL OPTICAL OUT jacks. Video sources can be recorded to a video recorder (e.g., VCR, DVD recorder) connected to the VIDEO 1 OUT or VIDEO 2 OUT jacks. See pages 22 to 34 for hookup information.

<p><b>1</b></p>	<p><b>Use the input selector buttons to select the source that you want to record.</b></p> <p>See "Which Connections Should I Use?" on page 23 to see which signals can be output and recorded.</p> <p>You can watch the source while recording. The AV receiver's Volume control has no effect on recording.</p>
<p><b>2</b></p>	<p><b>On your recorder, start recording.</b></p>
<p><b>3</b></p>	<p><b>On the source component, start playback.</b></p>

## Note:

- If you select another input source during recording, that input source will be recorded.

## Recording Audio and Video from Separate Sources

You can overdub audio onto your video recordings by simultaneously recording audio and video from two separate sources. This is possible because only the audio source is switched when an audio-only input source, such as TAPE, TUNER, or CD, is selected, the video source remains the same.

In the following example, audio from the CD player connected to the CD IN and video from the camcorder connected to the VIDEO 3 IN jack are recorded by the VCR connected to the VIDEO 1 OUT jacks.

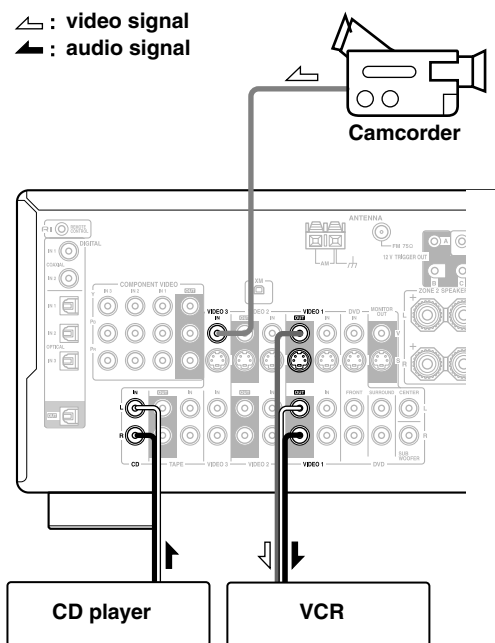

- 1 Prepare the camcorder and CD player for playback.**
- 2 Prepare the VCR for recording.**
- 3 Press the [Video 3] input selector button.**
- 4 Press the [CD] input selector button.**  
This selects the CD player as the audio source but leaves the camcorder as the video source.
- 5 Start recording on the VCR, then start playback on the camcorder and CD player.**  
Video from the camcorder and audio from the CD player are recorded by the VCR.

# Onscreen Setup Menus

## About the Onscreen Setup Menus

The onscreen setup menus are displayed on the connected TV and provide a convenient way to change the AV receiver's settings, which are arranged into two groups: *First Time Setup* and *Advanced Setup*.

To get your system up and running, you must complete the First Time Setup settings. The Advanced Setup settings are more detailed and allow you to tailor the AV receiver to suit your requirements.

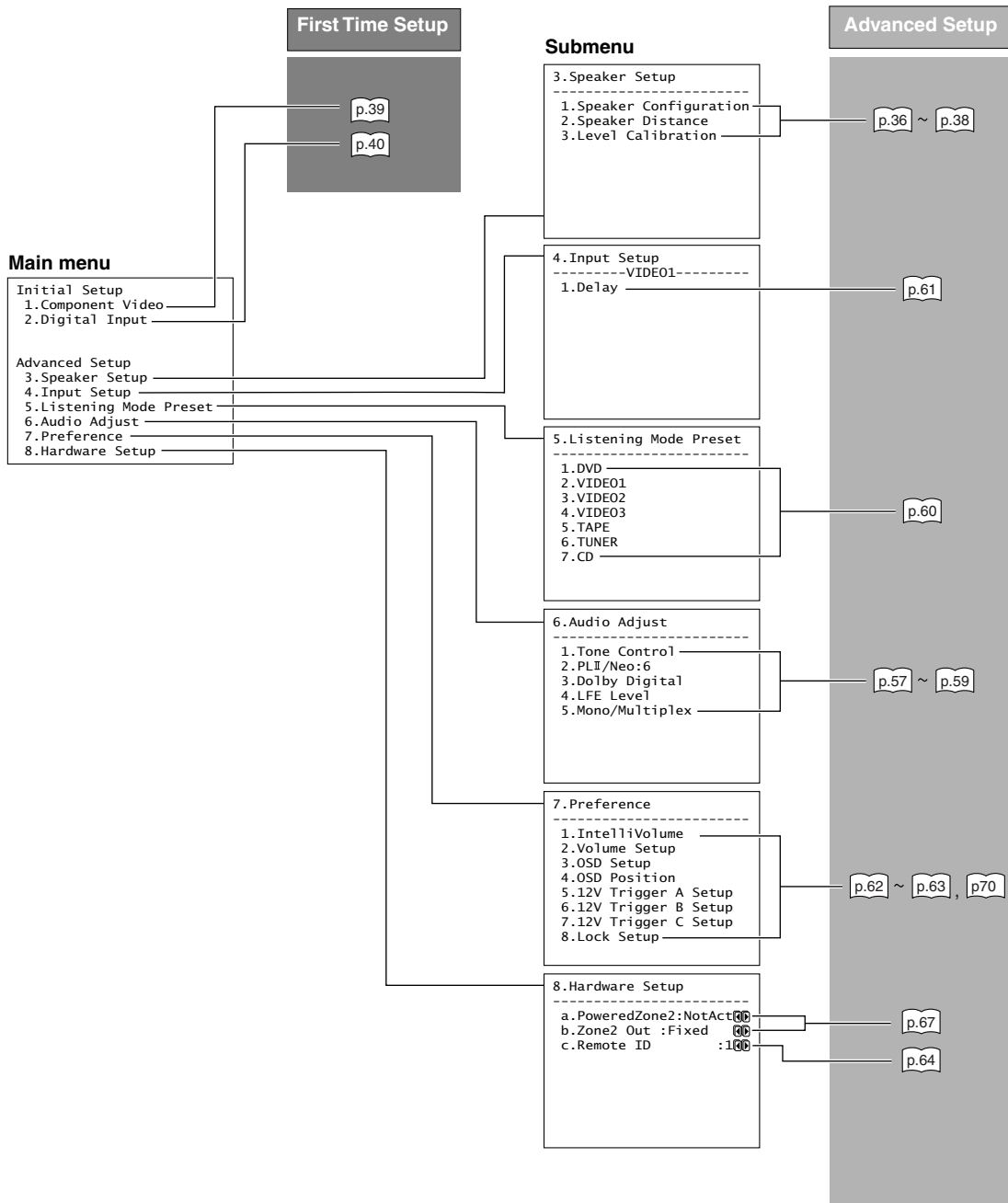



# Adjusting the Listening Modes

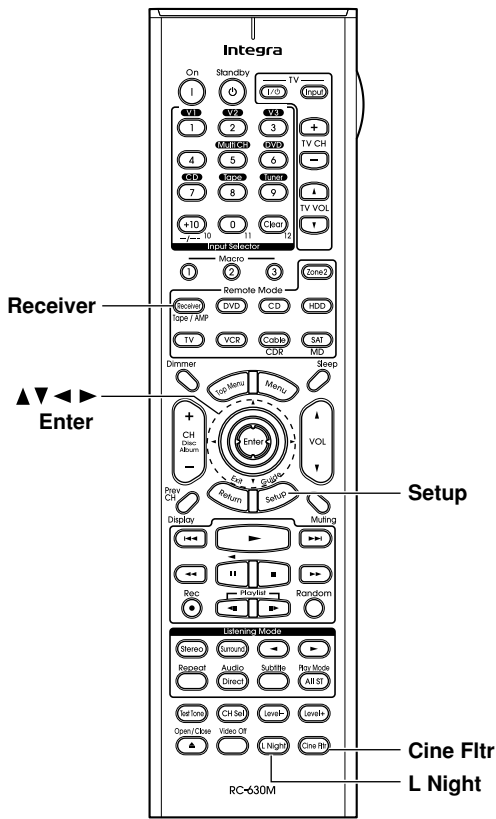

## Using the Cine Filter Function

With the Cine Filter function, you can correct a soundtrack whose high-frequency content is too harsh, making it more suitable for home theater viewing. This function can be used with the following listening modes: Dolby Digital, Dolby Pro Logic II Movie, DTS, DTS Neo:6 Cinema, DTS 96/24, and Multichannel.

- 1** Press the [Receiver] Remote Mode button, followed by the [Cine Ftr] button. Press the [Cine Ftr] button again to turn off the Cine Filter function.

## Audio Adjust Menu

The Audio Adjust menu has various settings for adjusting the sound and listening modes.

- 1** Press the [Receiver] Remote Mode button, followed by the [Setup] button. The main menu appears onscreen.
- 2** Use the Up and Down [▲]/[▼] buttons to select "6. Audio Adjust," and then press [Enter]. The Audio Adjust menu appears.

6. Audio Adjust

---

1. Tone Control  
 2. PLII/Neo:6  
 3. Dolby Digital  
 4. LFE Level  
 5. Mono/Multiplex
- 3** Use the Up and Down [▲]/[▼] buttons to select a setting, and then press [Enter]. The menu for the selected setting appears.
- 4** Use the Up and Down [▲]/[▼] buttons to select an option, and use the Left and Right [◀]/[▶] buttons to change it. The Audio Adjust settings are explained on the next page.
- 5** When you've finished, press the [Setup] button. Setup closes.

## Adjusting the Listening Modes—Continued

### Tone Control Settings

You can adjust the bass and treble for the front speakers. The tone control circuits are bypassed in the Direct listening mode.

#### ■ Bass

You can boost or cut low-frequency sounds output by the front speakers from  $-10$  dB to  $+10$  dB in 1 dB steps.

#### ■ Treble

You can boost or cut high-frequency sounds output by the front speakers from  $-10$  dB to  $+10$  dB in 1 dB steps.

### Setting the Bass and Treble on the AV Receiver:

#### Note:

The AV receiver's Tone buttons cannot be used in the Direct listening mode.

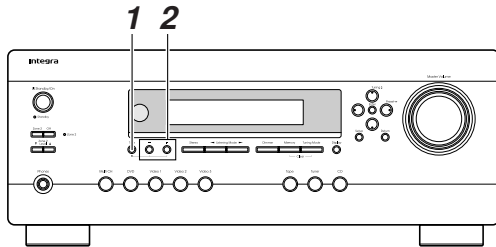

**1**  Press the AV receiver's [Tone] button repeatedly to select either Bass or Treble.

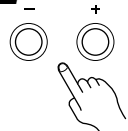
**2**  Use the Tone [-]/[+] buttons to adjust.

### PL II and Neo:6 Settings

#### PL II Music (2 ch only)

These settings only apply to 2-channel (stereo) sources.

#### ■ Panorama

With this setting, you can broaden the width of the front stereo image when using the Pro Logic II Music listening mode.

**On:** Panorama function on.

**Off:** Panorama function off (default).

#### ■ Dimension

With this setting, you can move the sound field forward or backward when using the Pro Logic II Music listening mode. The default value is 3. Higher settings move the sound field forward. Lower settings move it backward. It can be adjusted from 0 to 6.

If the stereo image feels too wide, or there's too much surround sound, move the sound field forward to improve the balance. Conversely, if the stereo image feels like it's in mono, or there's not enough surround sound, move it backward.

#### ■ Center Width

With this setting, you can adjust the width of the sound from the center speaker when using the Pro Logic II Music listening mode. Normally if you're using a center speaker, the center channel sound is output by only the center speaker. (If you're not using a center speaker, the center channel sound will be distributed to the front left and right speakers to create a phantom center). This setting adjusts the front left, right, and center mix, allowing you to adjust the weight of the center channel sound. It can be adjusted from 0 to 7 (default value is 3).

### Neo:6 Music

#### ■ Center Image

The DTS Neo:6 Music listening mode creates 5.1-channel surround sound from 2-channel (stereo) sources.

With this setting, you can specify by how much the front left and right channel output is attenuated in order to create the center channel. It can be adjusted from 0 to 5 (default value is 3). This setting is unavailable if no surround speakers are connected.

When set to 0, the front left and right channel output is attenuated by half ( $-6$  dB), giving the impression that the sound is located centrally. This setting works well when the listening position is considerably off center. When set to 5, the front left and right channels are not attenuated, maintaining the original stereo balance.

## Adjusting the Listening Modes—Continued

### Dolby Digital Settings

#### ■ Late Night

With the Late Night function, you can reduce the dynamic range of Dolby Digital material so that you can still hear quiet parts even when listening at low volume levels—ideal for watching movies late at night when you don't want to disturb anyone.

**Off:** Late Night function off.

**Low:** Small reduction in dynamic range.

**High:** Big reduction in dynamic range.

#### Setting Late Night with the Remote Controller

The remote controller can be used to set the Late Night function only when the input source is Dolby Digital.



**Press the [Receiver] Remote Mode button, and then press the [L Night] button repeatedly to select: Off, Low, or High.**

#### Notes:

- The effect of the Late Night function depends on the Dolby Digital material that you are playing, and with some material there will be little or no effect.
- The Late Night function is set to Off when the AV receiver is set to Standby.

### LFE Level Setting

With this setting, you can set the level of the LFE (Low Frequency Effects) channel for Dolby Digital, DTS and MCH Ana (multichannel DVD input). The level can be set to  $-\infty$ ,  $-20$  dB,  $-10$  dB, or  $0$  dB (default).

If you find that the low-frequency effects are too loud when using one of these sources, set the level to  $-20$  dB or  $-\infty$  dB.

### Mono/Multiplex Settings

#### Mono

##### ■ Input Ch

This setting determines which channel is output when the Mono listening mode is used with a stereo source.

**Auto L+R:** Both the left and right channels are output (default).

**Left:** Only the left channel is output.

**Right:** Only the right channel is output.

##### ■ Output Sp

This setting determines which speakers output mono audio when the Mono listening mode is selected.

**Front:** Mono audio is output from the front left and right speakers.

**Center:** Mono audio is output from the center speaker (default).

#### Multiplex

##### ■ Multiplex

This setting determines which channel of a stereo multiplex source is output. Use it to select audio channels or languages with multiplex sources, multilingual TV broadcasts, and so on.

**Main:** The main channel is output (default).

**Sub:** The sub channel is output.

**Main/Sub:** Both the main and sub channels are output.

## Adjusting the Listening Modes—Continued

### Default Listening Modes

You can specify a default listening mode for each signal format supported by each input selector. The AV receiver will then automatically select that listening mode based on the format of the input signal. You can select other listening modes while listening to a source, but the default listening mode specified here will be used next time you turn on the AV receiver.

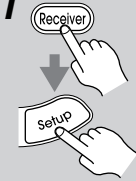
**1** 

**Press the [Receiver] Remote Mode button, followed by the [Setup] button.**  
The main menu appears onscreen.

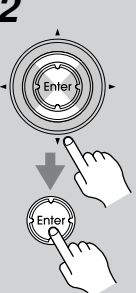
**2** 

**Use the Up and Down [▲]/[▼] buttons to select “5. Listening Mode Preset,” and then press [Enter].**  
The Listening Mode Preset menu appears.

```

5.Listening Mode Preset
-----
1.DVD
2.VIDEO1
3.VIDEO2
4.VIDEO3
5.TAPE
6.TUNER
7.CD
                    
```

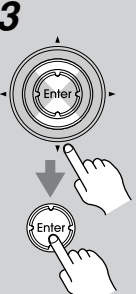
**3** 

**Use the Up and Down [▲]/[▼] buttons to select an input selector, and then press [Enter].**  
The options for that input selector appear.

```

5-2.ListeningMode Preset
-----VIDE01-----
      ▲
a.Ana/PCM
  :All Ch Stereo  ⓀⓀ
b.Dolby D
  :Dolby Digital  ⓀⓀ
c.DTS
  :DTS             ⓀⓀ
      ▼
                    
```

For the Tuner input selector, the only signal format is “Ana/PCM.”

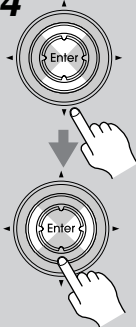
**4** 

**Use the Up and Down [▲]/[▼] buttons to select a signal format, and then use the Left and Right [◀]/[▶] buttons to select a listening mode.**  
Only listening modes compatible with each signal format can be selected.  
The signal formats are explained below.

**5** 

**When you’ve finished, press the [Setup] button.**  
Setup closes.

**Note:**

This procedure can also be performed on the AV receiver by using its [Setup] button, arrow buttons, and [Enter] button.

**Ana/PCM:** Specifies the default listening mode for analog sources and PCM digital audio sources.

**Dolby D:** Specifies the default listening mode for Dolby Digital sources.

**DTS:** Specifies the default listening mode for DTS sources.

**D.F. 2ch:** Specifies the default listening mode for 2-channel (2/0) stereo sources in a digital format, such as Dolby Digital and DTS.

**D.F. Mono:** Specifies the default listening mode for mono sources in a digital format, such as Dolby Digital and DTS.

**MCH Ana:** Specifies the default listening mode for the analog multichannel DVD input. This option is only available for the “1. DVD” input selector.

# Advanced Setup

## Input Setup

This section explains items on the "Input Setup" menu.

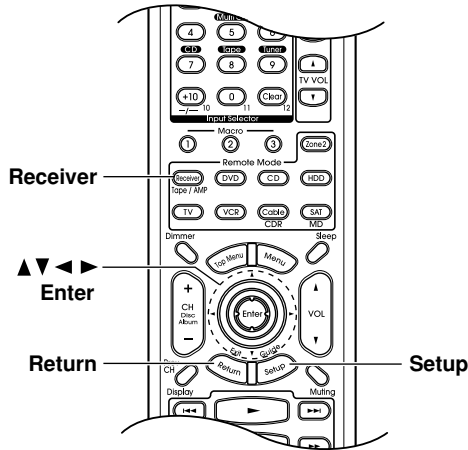

## Delay

### A/V Sync

When using progressive scanning, you may find that the picture and sound are out of sync. With this setting, you can correct this by delaying the audio signals from 0 to 100 milliseconds (ms) in 1 millisecond steps.

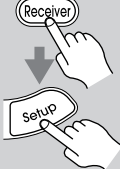
**1**  **During playback, press the [Receiver] Remote Mode button, followed by the [Setup] button.**  
The main menu appears onscreen.

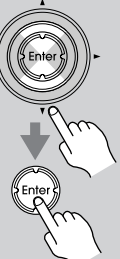
**2**  **Use the Up and Down [▲]/[▼] buttons to select "4. Input Setup," and then press [Enter].**  
The Input Setup menu appears.

4.Input Setup  
-----VIDE01-----  
1.Delay

**3**  **Use the Up and Down [▲]/[▼] buttons to select "Delay," and then press [Enter].**  
The Delay menu appears.

4-1.Delay  
-----VIDE01-----  
a.A/V Sync : 45ms

Press Enter to see picture while adjusting.

Press Return to return to setup.

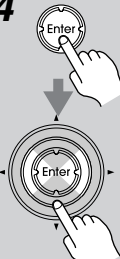
**4**  **Press [Enter] to see the TV picture, and use the Left and Right [◀]/[▶] buttons to adjust the delay so that the sound and picture are in sync.**  
Press the [Return] button to return to the Delay menu.

**5**  **When you've finished, press the [Setup] button.**  
Setup closes.

**Note:**

- This procedure can also be performed on the AV receiver by using its [Setup] button, arrow buttons, and [Enter] button.

## Advanced Setup—Continued

### Preferences

This section explains items on the “Preference” menu.

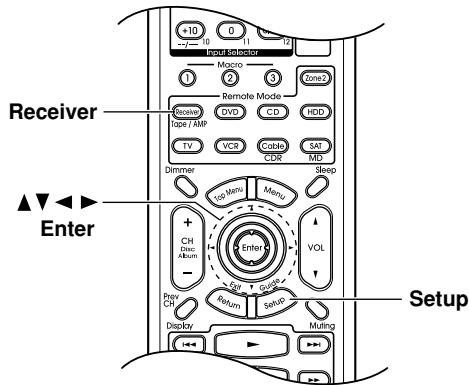

4

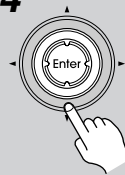

Use the Up and Down [▲]/[▼] buttons to select an option, and use the Left and Right [◀]/[▶] buttons to change it.

The preferences are explained in the next column.

5



When you've finished, press the [Setup] button.

Setup closes.

#### Note:

- This procedure can also be performed on the AV receiver by using its [Setup] button, arrow buttons, and [Enter] button.

**1**

**Press the [Receiver] Remote Mode button, followed by the [Setup] button.**  
The main menu appears onscreen.

**2**

**Use the Up and Down [▲]/[▼] buttons to select “7. Preference,” and then press [Enter].**  
The Preference menu appears.

7.Preference

---

1.IntelliVolume  
2.Volume Setup  
3.OSD Setup  
4.OSD Position  
5.12V Trigger A Setup  
6.12V Trigger B Setup  
7.12V Trigger C Setup  
8.Lock Setup

**3**

**Use the Up and Down [▲]/[▼] buttons to select a preference, and then press [Enter].**

### IntelliVolume

With this preference, you can set the input level for each input source. This is useful if some of your components are louder or quieter than others.

Use the Up and Down [▲]/[▼] buttons to select an input selector, and use the Left and Right [◀]/[▶] buttons to set the level.

If a component is too loud compared to your other components, use the Left [◀] button to reduce its input level. If it's too quiet, use the Right [▶] button to increase its input level. The level can be set from -12 dB to +12 dB.

### Volume Setup

#### ■ Volume Display

With this preference, you can choose how the volume level is displayed.

**Absolute:** Display range is MIN, 1 through 99, MAX.

**Relative:** Display range is -∞ dB, -81 dB, -80 dB through +18 dB.

The absolute value 82 is equivalent to the relative value 0 dB.

#### ■ Muting Level

This preference determines how much the output is muted when the Muting function is used (see page 50). It can be set to -∞ dB (default) or between -50 dB and -10 dB in 10 dB steps.

#### ■ Maximum Vol / Z2 Maximum Vol

With these preferences, you can prevent the volume being set too high by specifying maximum volume levels for the main room and Zone 2.

When the “Volume Display” preference is set to “Absolute,” the range of “Maximum Vol” is 50 to 99 (“Z2 Maximum Vol” is 50 to 81). When it's set to “Relative,” the range of “Maximum Vol” is -32 dB through +17 dB (“Z2 Maximum Vol,” the range is -32 dB through -1 dB). To specify no maximum volume, select “Off.”

## Advanced Setup—Continued

### ■ Power On Vol / Z2 Power On Vol

With these preferences, you can specify the volume settings to be used in the main room and Zone 2 when the AV receiver is turned on.

When the Volume Display preference is set to Absolute, the range of “Power On Vol” is 0 to 100 (“Z2 Power On Vol” is 0 to 82). When it’s set to Relative, the range of “Power On Vol” is  $-\infty$  dB,  $-81$  dB to  $+18$  dB (“Z2 Power On Vol” is  $-\infty$  dB,  $-81$  dB to 0 dB).

To use the same volume level as when the AV receiver was turned off, select “Last.”

The “Power On Vol” cannot be set higher than the “Maximum Vol” setting.

### ■ Headphones Level

With this preference, you can specify the headphone volume relative to the main volume. This is useful if there’s a volume difference between your speakers and your headphones. The headphones level can be set from  $-12$  dB to  $+12$  dB.

### OSD Setup

#### ■ Scan Mode

If the text in the onscreen setup menus flickers due to compatibility issues with your TV or projector, select Non-Interlaced.

**Interlaced:** Default.

**Non-Interlaced:** Select if the menu text flickers.

With some TVs or projectors, the onscreen setup menus may not appear when “Non-Interlaced” is selected. In this case, select this setting again by using the AV receiver’s display, and select “Interlaced.”

#### Immediate

These settings determine how the operation details are displayed.

#### ■ Immediate Display

This preference determines whether operation details are displayed onscreen when an AV receiver function is adjusted.

**On:** Displayed (default).

**Off:** Not displayed.

Even when On is selected, operation details are not output if the input source is connected to a COMPONENT VIDEO IN.

#### ■ Monitor Type

With this preference, you can specify the aspect ratio of your TV so that the operation details are displayed properly.

**4:3:** Select if your TV is 4:3 (default).

**16:9:** Select if your TV is 16:9.

#### ■ Display Position

This preference determines where on the screen operation details are displayed.

**Bottom:** Bottom of the screen (default).

**Top:** Top of the screen.

### OSD Position

With this preference, you can specify the position of the onscreen setup menus. This is useful with TVs or projectors where the menus don’t appear in the center of the screen, or part of the menu is cut off.

To set the menu position, use the arrow [ $\blacktriangle$ ]/[ $\blacktriangledown$ ]/[ $\blacktriangleleft$ ]/[ $\blacktriangleright$ ] buttons. To set it back to its default position, press [ENTER].

### 12V Trigger A/B/C Setup

See page 70.

### Lock Setup

#### ■ Lock

With this preference, you can protect your settings by locking the setup menus.

When the setup menus are locked, only settings on the Audio Adjust menu can be changed.

**Locked:** Setup menus locked.

**Unlocked:** Setup menus not locked.

## Advanced Setup—Continued

### Remote IDs

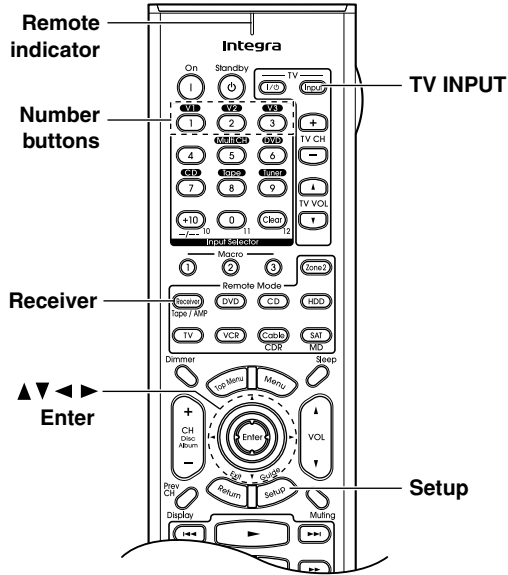

**3** Use the Up and Down [**▲**]/[**▼**] buttons to select "Remote ID," and use the Left and Right [**◀**]/[**▶**] buttons to select ID 1, 2, or 3.

```
8.Hardware Setup
-----
a.PoweredZone2:NotAct 00
b.Zone2 Out :Fixed 00
c.Remote ID :100
```

**4** Press the [Setup] button. Setup closes.

**Note:**

- This procedure can also be performed on the AV receiver by using its [Setup] button, arrow buttons and [Enter] button.

### Changing the AV Receiver's Remote ID

When several Integra components are used in the same room, their remote ID codes may overlap. To differentiate the AV receiver from the other components, you can change its remote ID from 1, the default, to 2 or 3.

**Note:**

If you change the AV receiver's remote ID, be sure to set the remote controller to the same ID (see next column).

**1** Press the [Receiver] Remote Mode button, followed by the [Setup] button. The main menu appears onscreen.

**2** Use the Up and Down [**▲**]/[**▼**] buttons to select "8. Hardware Setup," and then press [Enter]. The Hardware Setup menu appears.

### Changing the Remote Controller's ID

To differentiate the remote controller from other Integra components, you can change its remote ID so that it matches the AV receiver's Remote ID setting.

**Note:**

If you change the remote controller's remote ID, be sure to set the AV receiver to the same ID. Otherwise, you won't be able to control it (see previous column).

**1** Press and hold down the [Receiver] Remote Mode button, and then press the TV [Input] button. The Remote indicator flashes four times.

**2** Use the number buttons to enter remote control ID 1, 2, or 3. The Remote indicator flashes twice.



## Advanced Setup—Continued

### Digital Input Signal Formats

Normally, the AV receiver detects the signal format automatically. However, if you experience either of the following issues when playing PCM or DTS material, you can specify the signal format as either PCM or DTS:

- If the beginnings of tracks from a PCM source are cut off, try the PCM setting.
- If noise is produced when fast forwarding or rewinding a DTS CD, try the DTS setting.

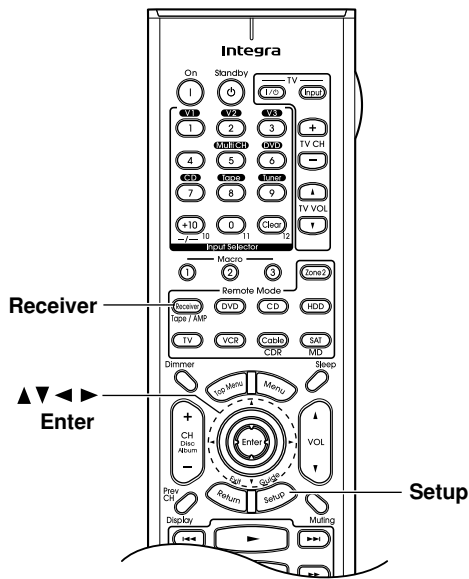

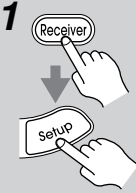

**1** Press the [Receiver] Remote Mode button, followed by the [Setup] button.  
The main menu appears onscreen.

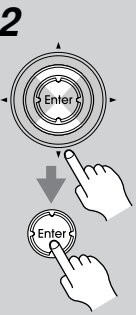

**2** Use the Up and Down [▲]/[▼] buttons to select "2. Digital Input," and then press [Enter].

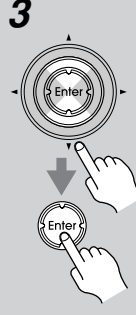

**3** Use the Up and Down [▲]/[▼] buttons to select an input source that's assigned to a digital input (opt or coax), and then press [Enter].  
The Digital Format menu appears.

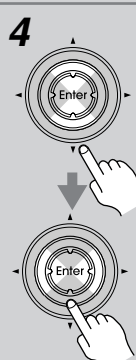

**4** Use the Up and Down [▲]/[▼] buttons to select the input, and use the Left and Right [◀]/[▶] buttons to select: PCM, DTS, or Auto.  
**PCM:** The PCM indicator flashes, and only input signals in PCM format will be output.  
**DTS:** The DTS indicator flashes, and only input signals in DTS format will be output.  
**Auto (default):** The format is detected automatically. If no digital input signal is present, the corresponding analog input is used instead.



**5** Press the [Setup] button.  
Setup closes.

2-1. Digital Format	
a. DVD	: Auto
b. VIDE01	: Auto
c. VIDE02	: ---
d. VIDE03	: Auto
e. TAPE	: ---
f. CD	: Auto

**Note:**

- This procedure can also be performed on the AV receiver by using its [Setup] button, arrow buttons, and [Enter] button.

## Zone 2

### Connecting Zone 2

With the Zone 2 function, you can enjoy one input source in the main room and a different input source in another room.

**There are two ways to hook up your Zone 2 speakers:**

- 1) Use another amp (receiver, integrated amp, or power amp) in Zone 2 and connect your Zone 2 speakers to it.
- 2) Connect your Zone 2 speakers to this AV receiver.

### Using Another Amp in Zone 2

With this hookup, you can enjoy 5.1-channel playback in the main room and a different stereo source in Zone 2.

**If you use a receiver or integrated amp in Zone 2,** the volume for Zone 2 is adjusted on that unit. **If you use a power amp with no volume control in Zone 2,** the volume for Zone 2 is adjusted on this AV receiver.

#### Hookup

- Use an RCA audio cable to connect the AV receiver's ZONE 2 OUT L/R jacks to an analog audio input on the amp in Zone 2.
- Connect the Zone 2 speakers to the speaker terminals on the amp in Zone 2.

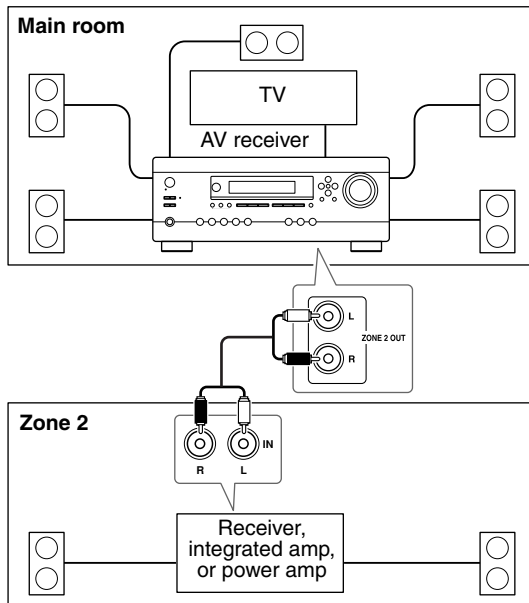

If you're using a receiver or integrated amp in Zone 2, you don't need to make any settings to use this hookup. Proceed to "Using Zone 2" on page 68.

If you're using a power amp with no volume control in Zone 2, you must set the Zone 2 Out setting to Variable (see page 67).

### Using Only Speakers in Zone 2

With this hookup, you can enjoy stereo playback in the main room and a different stereo source in Zone 2. The volume for Zone 2 is set on this AV receiver.

#### Hookup

- Connect your Zone 2 speakers to the AV receiver's ZONE 2 SPEAKERS terminals.

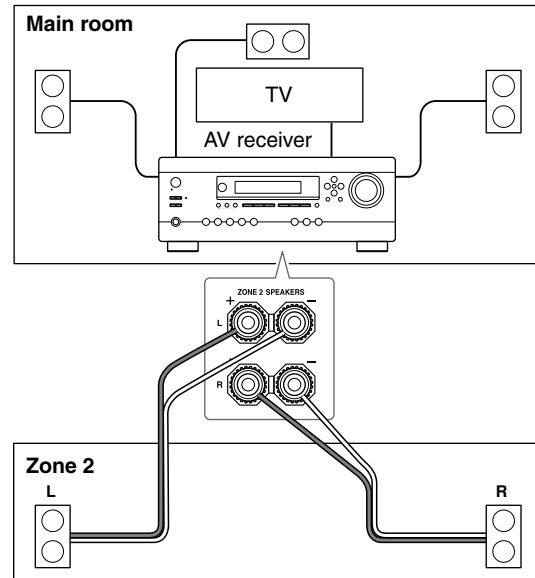



You must set the "Powered Zone 2" setting to "Act" (Activated) in order to use this hookup (see page 67).

## Zone 2—Continued

### Powered Zone 2 Setting

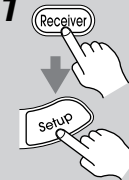
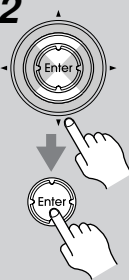
If you've connected your Zone 2 speakers to this AV receiver, as explained in "Using Only Speakers in Zone 2" on page 66, you must set the Powered Zone 2 setting to Act (Activated) as explained here.

	<p><b>1 Press the [Receiver] Remote Mode button, followed by the [Setup] button.</b> The main menu appears onscreen.</p>
	<p><b>2 Use the Up and Down [▲]/[▼] buttons to select "8. Hardware Setup," and then press [Enter].</b> The Hardware Setup menu appears.</p>
	<p><b>3 Use the Up and Down [▲]/[▼] buttons to select "Powered Zone2," and use the Left and Right [◀]/[▶] buttons to select:</b></p> <div style="border: 1px solid black; padding: 5px; margin: 10px 0;"> <pre>8. Hardware Setup ----- a. PoweredZone2:NotAct00 b. Zone2 Out :Fixed 00 c. Remote ID :100</pre> </div> <p><b>Not Act:</b> ZONE 2 SPEAKERS terminals not activated. <b>Act:</b> ZONE 2 SPEAKERS terminals activated.</p> <p>When Act is selected and Zone 2 is turned on, the speakers connected to the ZONE 2 SPEAKERS terminals will output sound. When Zone 2 is turned off, even if Act is selected, the surround speakers will work as normal.</p>
	<p><b>4 Press the [Setup] button.</b> Setup closes.</p>

### Zone 2 Out Setting

If you've connected your Zone 2 speakers to a power amp with no volume control in Zone 2, as explained in "Using Another Amp in Zone 2" on page 66, you must set the Zone 2 Out setting to Variable.

When set to Variable, the ZONE 2 OUT L/R jacks work like pre outs.

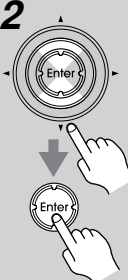
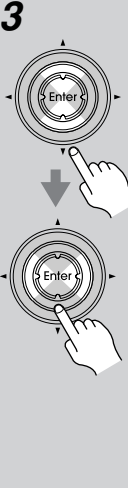
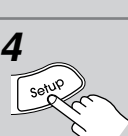
	<p><b>1 Press the [Receiver] Remote Mode button, followed by the [Setup] button.</b> The main menu appears onscreen.</p>
	<p><b>2 Use the Up and Down [▲]/[▼] buttons to select "8. Hardware Setup," and then press [Enter].</b> The Hardware Setup menu appears.</p>
	<p><b>3 Use the Up and Down [▲]/[▼] buttons to select "Zone 2 Out," and use the Left and Right [◀]/[▶] buttons to select:</b></p> <div style="border: 1px solid black; padding: 5px; margin: 10px 0;"> <pre>8. Hardware Setup ----- a. PoweredZone2:NotAct00 b. Zone2 Out :Fixed 00 c. Remote ID :100</pre> </div> <p><b>Fixed:</b> The ZONE 2 OUT L/R jacks work as line outs, and the volume for Zone 2 is set on the receiver or integrated amp in Zone 2. <b>Variable:</b> The ZONE 2 OUT L/R jacks work as pre outs, and the volume for Zone 2 is set on this AV receiver.</p>
	<p><b>4 Press the [Setup] button.</b> Setup closes.</p>

**Note:**

- These settings can also be changed on the AV receiver by using its [Setup] button, arrow buttons, and [Enter] button.

## Zone 2—Continued

### Using Zone 2

This section explains how to turn Zone 2 on and off, how to select an input source for Zone 2, and how to adjust the volume for Zone 2.

### Controlling Zone 2 from the AV Receiver

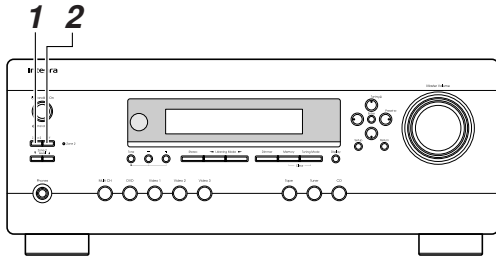

**1**



To turn on Zone 2 and select an input source, press the [Zone 2] button repeatedly.

Alternatively, press the [Zone 2] button followed by an input selector button within 8 seconds.

Zone 2 turns on, the Zone 2 indicator lights up, and the ZONE 2 12V TRIGGER OUT goes high (+12 V).

To select AM, FM, or XM, press the [Tuner] input selector button repeatedly.

To select the same source as that of the main room, press the [Zone 2] button repeatedly until “Zone 2 Sel: Source” appears.

**2**



To turn off Zone 2, press the Zone 2 [Off] button.

### Controlling Zone 2 with the Remote Controller

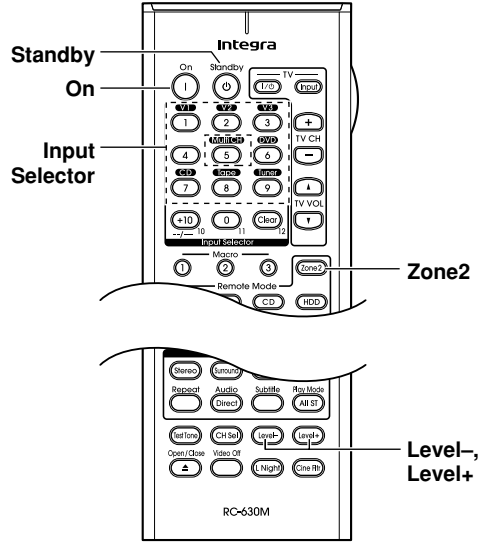

**Note:**

- To control Zone 2, you must press the remote controller's [Zone 2] Remote Mode button first.

**1**

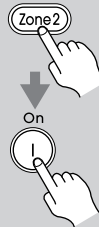

Press the [Zone 2] Remote Mode button, then point the remote controller at the AV receiver and press the [On] button.

Zone 2 turns on, and the ZONE 2 12V TRIGGER OUT goes high (+12 V).

**2**

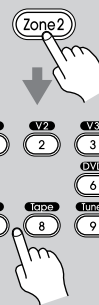

To select an input source for Zone 2, press the [Zone 2] Remote Mode button, followed by an Input Selector button.

To select AM, FM, or XM, press the [Tuner] Input Selector button repeatedly.

**3**



To turn off Zone 2, press the [Zone 2] Remote Mode button, followed by the [Standby] button.

## Zone 2—Continued

### Adjusting the Volume for Zone 2

**Zone 2 Level ▲,▼**

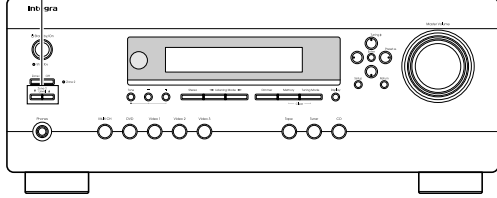

**1** On the remote controller, press the [Zone 2] Remote Mode button, and then use the [Level-] and [Level+] buttons.

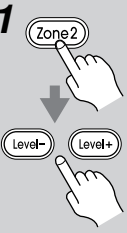

**On the AV receiver, use the Zone 2 Level [▲]/[▼] buttons.**

The volume can be set to  $-\infty$  dB,  $-81$  dB  $-80$  dB through  $0$  dB in Relative display (Min.1 through 81, Max in Absolute display).

If your Zone 2 speakers are connected to a receiver or integrated amp in Zone 2, use its volume control to adjust the volume.



#### To Mute Zone 2:

Press the remote controller's [Zone 2] button, followed by the [Muting] button. To unmute Zone 2, press the remote controller's [Zone 2] button again, followed by the [Muting] button, or adjust the volume for Zone 2.

#### Notes:

- Only analog input sources are output by the ZONE 2 OUT jacks and ZONE 2 SPEAKERS terminals. Digital input sources are not output. If no sound is heard when an input source is selected, check to see if it's connected to an analog input.
- When the ZONE 2 SPEAKERS terminals are used, listening modes that require surround speakers, such as Dolby PLII and DTS Neo:6 are unavailable.
- While Zone 2 is on, the **RI** functions do not work.
- You can't select different radio stations for the main room and Zone 2. The same radio station will be used for both.

### Adjusting the Tone and Balance for Zone 2

You can adjust the bass, treble, and balance for Zone 2.

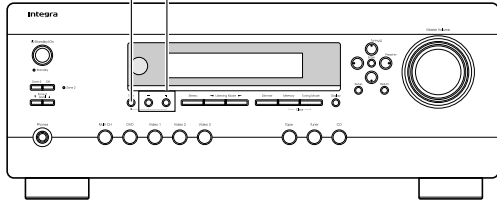

**1** Press the [Zone 2] button, and then press the [Tone] button repeatedly to select Bass, Treble, or Balance.



**2** Use the Tone [+] and [-] buttons to adjust.

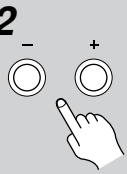

#### ■ Bass

You can boost or cut low-frequency sounds output by the front speakers from  $-10$  dB to  $+10$  dB in 2 dB steps.

#### ■ Treble

You can boost or cut high-frequency sounds output by the front speakers from  $-10$  dB to  $+10$  dB in 2 dB steps.

#### ■ Balance

You can adjust the balance of the left and right speakers in Zone 2 in 2 dB steps,  $+10$  dB to the right and  $+10$  dB to the left.

The balance cannot be adjusted when the Powered Zone 2 setting is set to Not Act (page 67) or the Zone 2 Out setting is set to Fixed (page 67).

## Zone 2—Continued

### Using the 12V Triggers in Zone 2 and the Main Room

When the AV receiver's 12 V TRIGGER OUT A/B/C jack is connected to the 12 V trigger input on a connected component, you can specify whether or not a 12-volt trigger signal is output when that component is selected as the source for the main room, Zone 2, or either.

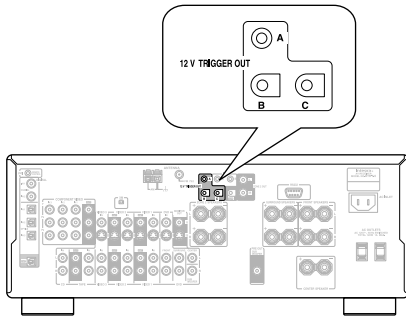

#### Hookup

- Use a miniplug cable to connect the AV receiver's 12 V TRIGGER OUT A, B, or C jack to the 12 V trigger input on the connected component.

<p><b>1</b></p>	<p><b>Press the [Receiver] Remote Mode button, followed by the [Setup] button.</b> The main menu appears onscreen.</p>
<p><b>2</b></p>	<p><b>Use the Up and Down [▲]/[▼] buttons to select "7. Preference," and then press [Enter].</b> The Preference menu appears.</p>
<p><b>3</b></p>	<p><b>Use the Up and Down [▲]/[▼] buttons to select "12V Trigger Setup" A, B, or C, and then press [Enter].</b></p>

<p><b>4</b></p>	<p><b>Use the Up and Down [▲]/[▼] buttons to select "Delay" or an input source, and use the Left and Right [◀]/[▶] buttons to change the setting.</b> Repeat this step as necessary for each setting.</p>
<p><b>5</b></p>	<p><b>Press the [Setup] button.</b> Setup closes.</p>

#### ■ Delay

When several components are turned on simultaneously via the 12-volt triggers, depending on the type of components, a large amount of current may be drawn momentarily. To prevent this, you can delay the trigger signals output by the AV receiver. In addition, by delaying the trigger signal for your power amplifier so that it's the last component to be turned on, you can avoid the "thump" noise that's sometimes heard when a source component is turned on.

The delay setting determines how long after the input source is changed on the AV receiver the trigger signal is output. It can be set to 0 sec, 1 sec, 2 sec, or 3 sec. When set to 0 sec, the trigger signal is output as soon as the input source is changed.

#### ■ 12V Trigger Setting for Each Input Source

By default, all input sources on the 12V Trigger A Setup menu are set to Main, those on the 12V Trigger B Setup menu are set to Main/Zone 2, and those on the 12V Trigger C Setup menu are set to Zone2.

**Off:** No trigger signal is output.

**Main:** Select this if you want to output a 12-volt trigger signal when a connected component is selected as the source for the main room.

**Zone2:** Select this if you want to output a 12-volt trigger signal when a connected component is selected as the source for Zone 2.

**Main/Zone2:** Select this if you want to output a 12-volt trigger signal when a connected component is selected as the source for either the main room or Zone 2.

## Zone 2—Continued

### Using the Remote Controller in Zone 2 and Multiroom Control Kits

To control the AV receiver with the remote controller while you're in the Zone 2 room, you'll need a commercially available multiroom remote control kit.

- Multiroom kits are made by Niles and Xantech. These kits can also be used when there isn't a clear line of sight to the AV receiver's remote sensor, such as when it's installed inside a cabinet.

### Using a Multiroom Kit with Zone 2

In this setup, the IR receiver in Zone 2 picks up the infrared signals from the remote controller and feeds them through to the AV receiver in the main room via the connecting block.

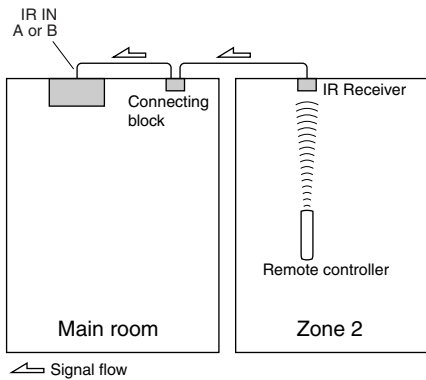

The miniplug cable from the connecting block should be connected to the AV receiver's IR IN A or B jack, as shown below. The IR IN A and B jacks are identical. Up to two IR receivers can be connected.

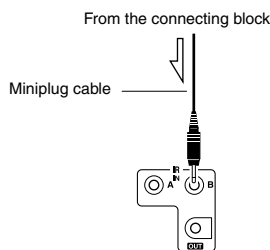

### Using a Multiroom Kit with a Cabinet

In this setup, the IR receiver picks up the infrared signals from the remote controller and feeds them to the AV receiver located in the cabinet via the connecting block.

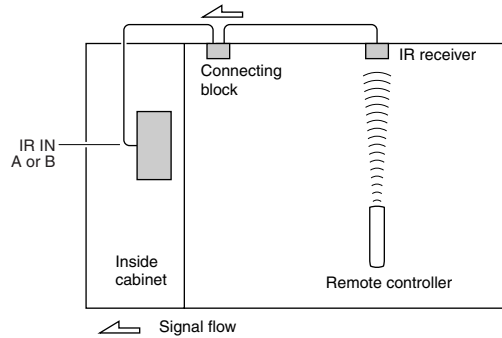

### Using a Multiroom Kit with Other Components

In this setup, an IR emitter is connected to the IR OUT jack and placed in front of the other component's remote control sensor. Infrared signals received at the AV receiver's IR IN A or B jack are fed through to the other component via the IR emitter. Signals picked up by the AV receiver's remote control sensor are not output.

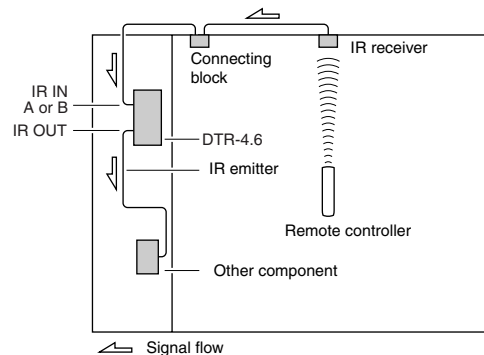

The IR emitter should be connected to the IR OUT jack, as shown below.

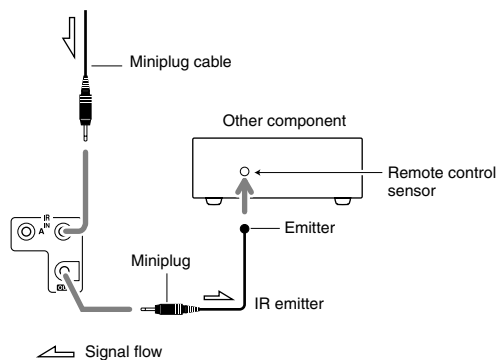

# Controlling Other Components

You can control your other components, including those made by other manufacturers, with the remote controller. This section explains how to:

- Enter the remote control code for a component that you want to control (e.g., DVD, TV, VCR).
- Learn commands directly from another component's remote controller (see page 75).
- Program the Macro buttons to perform a sequence of up to eight actions (see page 76).

## Entering Remote Control Codes

To control another component, you must first enter the appropriate remote control code to a Remote Mode button. You'll need to enter a code for each component that you want to control.

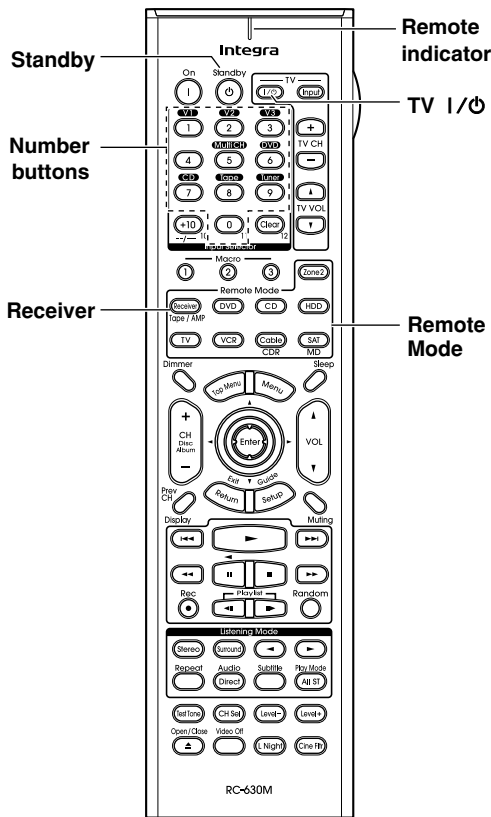

**1** Look up the appropriate remote control code in the separate Remote Control Codes list. The codes are organized by category. The Remote Mode buttons shown in the Remote Control Codes list may differ slightly to those on the actual remote controller. Operation is unaffected.

**2** While holding down the Remote Mode button to which you want to enter the code, press the [Standby] button. The Remote indicator lights up.

**3** Within 30 seconds, use the number buttons to enter the 4-digit remote control code. The Remote indicator flashes twice.

**4** Press the Remote Mode button again to select the remote controller mode, point the remote controller at the component, and check the operation.

If the remote controller doesn't work as expected, and several remote codes are listed, try each one in turn and use the one that works best.

- Notes:**
- Remote control codes cannot be entered for the [Receiver] and [HDD] Remote Mode buttons.
  - The remote control codes provided are correct at the time of printing, but are subject to change.

- The HDD remote mode can only be used with the Onkyo DS-A1 Remote Interactive Dock at this time.
- The [DVD] and [CD] Remote Mode buttons are preprogrammed for use with Integra DVD players and CD players respectively.

\* To control another manufacturer's CD recorder or MD recorder, enter the appropriate control code to the [CD] Remote Mode button.



## Controlling Other Components—Continued

### Remote Control Codes for Integra Components Connected via **RI**

Integra components that are connected via **RI** are controlled by pointing the remote controller at the AV receiver, not the component. This allows you to control components that are out of view, in a rack, for example.

**1** Make sure the Integra component is connected with an **RI** cable and an analog audio cable (RCA).  
See page 33 for details.

**2** Enter the appropriate remote control code for the Remote Mode button.

- [DVD] Remote Mode button  
**5002:** Integra DVD player with **RI**
- [CD] Remote Mode button  
**6002:** Integra CD player with **RI**
- [MD] Remote Mode button  
**6008:** Integra MD recorder with **RI**
- [CDR] Remote Mode button  
**6006:** Integra CD recorder with **RI**

See the previous page for how to enter remote control codes.

**3** Press the Remote Mode button, point the remote controller at the AV receiver, and operate the component.

If you want to control an Integra component by pointing the remote controller directly at it, or you want to control an Integra component that's not connected via **RI**, use the following remote control codes:

- [DVD] Remote Mode button  
**5001:** Integra DVD player without **RI** (default)
- [CD] Remote Mode button  
**6001:** Integra CD player without **RI** (default)
- [MD] Remote Mode button  
**6007:** Integra MD recorder without **RI**
- [CDR] Remote Mode button  
**6005:** Integra CD recorder without **RI**

#### Note:

If you connect an **RI**-capable Integra MiniDisc or CD recorder to the TAPE IN/OUT jacks, for remote operation to work properly, you must set the input display to MD or CDR (see page 41).

### Resetting the Remote Mode Buttons

You can reset a Remote Mode button to its default remote control code.

**1**

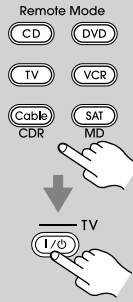

**While holding down the Remote Mode button that you want to reset, press the TV [I/O] button.**

The Remote indicator flashes three times.

**2**

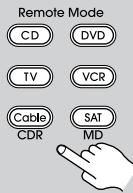

**Press the Remote Mode button again.**

The Remote indicator flashes twice, indicating that the button has been reset.

The [DVD] and [CD] Remote Mode buttons are preprogrammed with remote control codes for controlling Integra DVD players and CD players respectively. When these buttons are reset, the preprogrammed code is restored.

### Resetting the Remote Controller

You can reset the remote controller to its default settings.

**1**

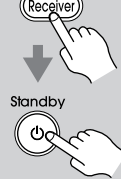

**While holding down the [Receiver] Remote Mode button, press the [Standby] button.**

The Remote indicator flashes five times.

**2**



**Press the [Receiver] Remote Mode button again.**

The Remote indicator flashes twice, indicating that the remote controller has been reset.

## Controlling Other Components—Continued

To control another component, point the remote controller at it and use the buttons explained below. (You must select the appropriate remote control mode first.) With some AV components, certain buttons may not work as expected, and some may not work at all.

### ■ Controlling a TV

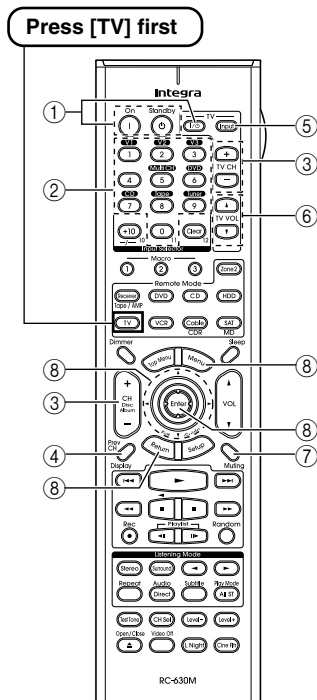

- ① **[On], [Standby], TV [On/Off]\***  
Set the TV to On or Standby.
- ② **Number buttons**  
Enter numbers.
- ③ **[CH +/-], TV CH +/-\***  
Select channels on the TV.
- ④ **[Prev CH]**  
Selects the previous channel.
- ⑤ **[TV Input]\***  
Selects the TV's external inputs.
- ⑥ **TV VOL [▲]/[▼]\***  
Adjust the TV's volume.
- ⑦ **[Muting]**  
Mutes the TV.
- ⑧ **[▲]/[▼]/[◀]/[▶]/[Menu]/[Enter]/[Return]**  
Navigate menus on the TV.

\* Buttons marked with an asterisk (\*) are exclusively for controlling a TV and can be used at any-time regardless of the current remote controller mode.

### ■ Controlling a VCR

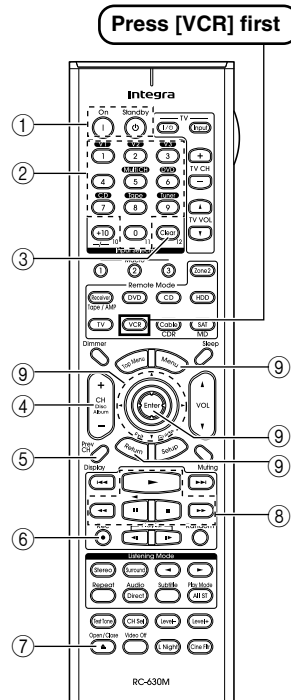

- ① **[On], [Standby]**  
Set the VCR to On or Standby.
- ② **Number buttons**  
Enter numbers.
- ③ **[Clear]**  
Cancels functions.
- ④ **[CH +/-]**  
Selects channels on the VCR.
- ⑤ **[Prev CH]**  
Selects the previous channel.
- ⑥ **Rec [●]**  
Starts recording.
- ⑦ **Eject [▲]**  
Ejects the videocassette.
- ⑧ **[▶], [⏸], [■], [◀], [▶▶]**  
Play, Pause, Stop, Rewind, and Fast forward.
- ⑨ **[▲]/[▼]/[◀]/[▶]/[Menu]/[Enter]/[Return]**  
Navigate menus on the VCR.

### ■ Controlling a Satellite or Cable Receiver

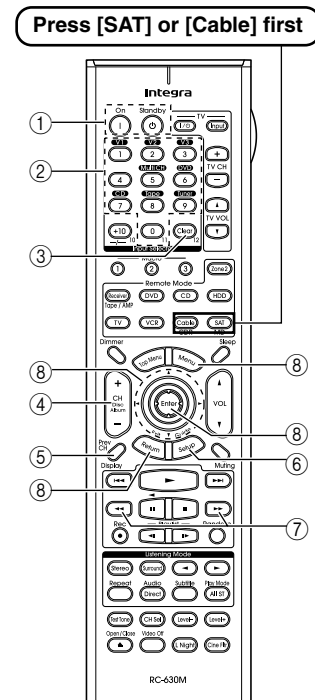

- ① **[On], [Standby]**  
Set the satellite/cable receiver to On or Standby.
- ② **Number buttons**  
Enter numbers.
- ③ **[Clear]**  
Cancels functions.
- ④ **[CH +/-]**  
Selects satellite/cable channels.
- ⑤ **[Prev CH]**  
Selects the previous channel.
- ⑥ **[Guide]**  
Displays the program guide.
- ⑦ **[◀◀], [▶▶]**  
Rewind and Fast forward.
- ⑧ **[▲]/[▼]/[◀]/[▶]/[Menu]/[Enter]/[Return]**  
Navigate menus on the satellite/cable receiver.

## Controlling Other Components—Continued

### Learning Commands from Other Remote Controllers

The AV receiver's remote controller can receive and learn commands from other remote controllers. By transmitting, for example, the Play command from your CD player's remote controller, the remote controller can learn it and then transmit the exact same command when its Play [▶] button is pressed in the CD remote mode. You can also use this function to learn individual commands after entering a remote control code (page 72).

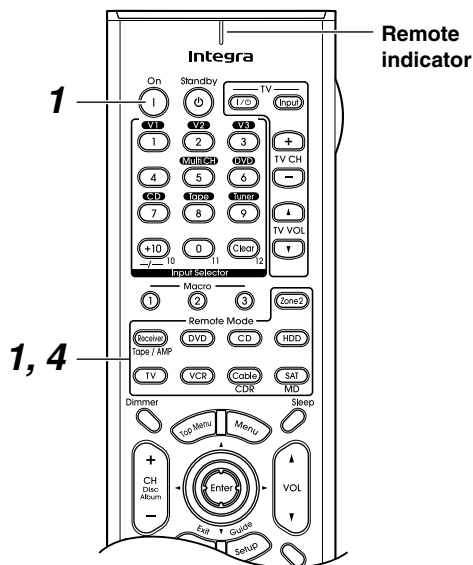

**3**

Point the remote controllers at each other, about 2 to 6 inches (5–15 cm) apart, and then press and hold the button whose command you want to learn until the Remote indicator flashes.

If the command is learned successfully, the Remote indicator flashes twice.

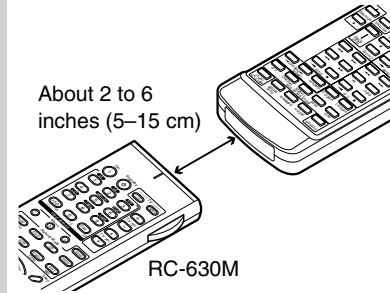

**4**

To learn more commands, repeat steps 2 and 3.

Press any Remote Mode button when you've finished.

#### Notes:

- The following buttons cannot learn new commands: Remote Mode, Macro [1], [2], [3], TV [I/⏻], TV [Input], TV CH [+]/[-], TV VOL [▲]/[▼], Light.
- The remote controller can learn approximately 70-90 commands, although, this will be reduced by commands that use a lot of memory.
- Remote controller buttons such as Play, Stop, Pause, and so on are preprogrammed with commands for controlling Integra CD players, cassette decks, and DVD players. However, they can learn new commands, and you can restore the preprogrammed commands by resetting the remote controller (see page 73).
- To overwrite a previously learned command, repeat this procedure.
- Only commands from infrared remote controllers can be learned.
- When the remote controller's batteries expire, all learned commands will be lost and will have to be learned all over again, so don't discard your other remote controllers.

**1**

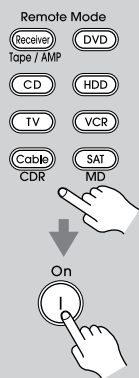

While holding down the Remote Mode button for the mode in which you want to use the command, press the [On] button.

The Remote indicator lights up.

**2**

On this AV receiver's remote controller, press the button you want to learn the new command.

## Controlling Other Components—Continued

### Using Macros

You can program the remote controller's Macro buttons to perform a sequence of actions.

#### Example:

To play a CD, you typically need to perform the following actions:

1. Press the [Receiver] Remote Mode button to select the Receiver remote controller mode.
2. Press the [On] button to turn on the AV receiver.
3. Press the [CD] Input Selector button to select the CD input source.
4. Press the [CD] Remote Mode button to select the CD remote controller mode.
5. Press the Play [▶] button to start playback on the CD player.

You can program a Macro button so that all five actions are performed with just one button press.

### Making Macros

You can make one macro for each Macro button, and each macro may contain up to eight commands.

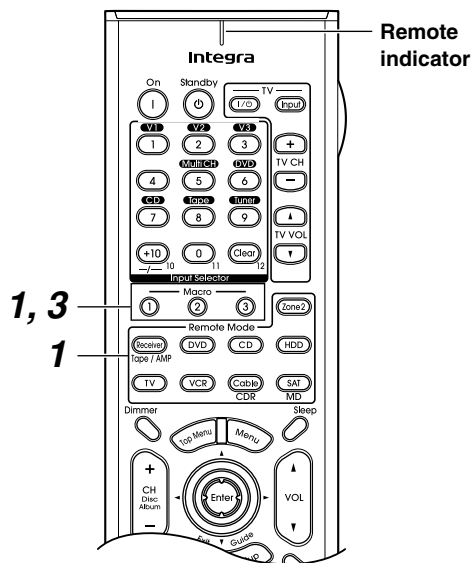

### 1

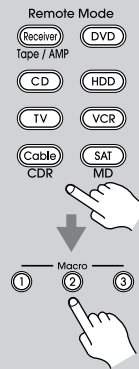

**While holding down the Remote Mode button for the mode you want to start with, press Macro button [1], [2], or [3].**

The Remote indicator lights up.

For the CD example in the left column, you'd press and hold the [Receiver] Remote Mode button, and then press Macro button [1], [2], or [3].

### 2

**On the remote controller, press the buttons whose actions you want to program into the macro in the order you want them performed.**

For the CD example in the left column, you'd press the following buttons: [On], Input Selector [CD], Remote Mode [CD], Play [▶].

### 3

**When you've finished, press the Macro button again.**

The Remote indicator flashes twice.

If you enter eight commands, the process will finish automatically.

#### Note:

- If one or more of the buttons you used to make a macro are taught new commands, the macro will no longer work properly and will have to be made again.

### Running Macros

### 1

**Press the Macro [1], [2], or [3] button.**

The commands in the macro are transmitted in the order in which they were programmed. Keep the remote controller pointed at the AV receiver until all of the commands have been transmitted.

Macros can be run at anytime regardless of the current remote controller mode.

### Deleting Macros

### 1

**While holding down the [Receiver] Remote Mode button, press the Macro button whose macro you want to delete.**

### 2

**Press the Macro button again.**

# Troubleshooting

If you have any trouble using the AV receiver, look for a solution in this section. If you can't resolve the issue yourself, contact the dealer from whom you purchased.

## Power

### Can't turn on the AV receiver

- Make sure that the power cord is plugged into the wall outlet properly.
- Unplug the power cord from the wall outlet, wait 5 seconds or more, then plug it in again.

### The AV receiver turns off as soon as it's turned on

- The amp protection circuit has been activated. Remove the power cord from the wall outlet immediately. Disconnect all speaker cables and input sources, and leave the AV receiver with its power cord disconnected for 1 hour. After that, reconnect the power cord and set the volume to maximum. If the AV receiver stays on, set the volume to minimum, disconnect the power cord, and reconnect your speakers and input sources. If the AV receiver turns off when you set the volume to maximum, disconnect the power cord, and contact the dealer from whom you purchased.

## Audio

### There's no sound or it's very quiet

- Make sure that the digital input source is selected properly (page 40).
- Make sure that all audio connecting plugs are pushed in all the way (page 22).
- Make sure that the polarity of the speaker cables is correct, and that the bare wire is in contact with metal part of each speaker terminal (page 19)
- Make sure that the speaker cables are not shorting.
- Check the volume (page 42). The AV receiver is designed for home theater enjoyment and has a wide volume range for precise adjustment.
- If the MUTING indicator is shown on the display, press the remote controller's [Muting] button to unmute the AV receiver (page 50).
- While a pair of headphones is connected to the Phones jack, no sound is output by the speakers (page 51).
- Check the digital audio output settings on the connected device. On some games consoles, such as those that can play DVDs, the default setting is off.
- With some DVD-Video discs, you need to select an audio format from a menu.
- If your turntable doesn't have a built-in phono preamp, you must connect one between it and the AV receiver. If your turntable uses an MC cartridge, you must connect an MC head amp, or an MC transformer (page 31).
- Check the speaker settings (pages 36–38).
- The input signal format is set to PCM or DTS. Set it to Auto (page 65).

### Only the front speakers produce sound

- When the Stereo listening mode is selected, only the front speakers and subwoofer produce sound.
- In the Mono listening mode, only the front speakers output sound when the Output Sp setting is set to Front (page 59).
- Make sure the speakers are configured correctly (pages 36, 37).

### Only the center speaker produces sound

- If you use the Pro Logic II Movie or Pro Logic II Music listening mode with a mono source, such as an AM radio station or mono TV program, the sound is concentrated in the center speaker.
- In the Mono listening mode, only the center speaker outputs sound when the Output Sp setting is set to Center (page 59).
- Make sure the speakers are configured correctly (pages 36, 37).

### The surround speakers produce no sound

- When the Stereo or Mono listening mode is selected, the surround speakers produce no sound.
- Depending on the source and current listening mode, not much sound may be produced by the surround speakers. Try selecting another listening mode.
- Make sure the speakers are configured correctly (pages 36, 37).
- When the ZONE 2 SPEAKERS terminals are used, playback in the main room is reduced to stereo (page 66).

### The center speaker produces no sound

- When the Stereo listening mode is selected, the center speaker produces no sound.
- In the Mono listening mode, only the front speakers output sound when the Output Sp setting is set to Front (page 59).
- Make sure the speakers are configured correctly (pages 36, 37).

### The subwoofer produces no sound

- When you play source material that contains no information in the LFE channel, the subwoofer produces no sound.
- Make sure the speakers are configured correctly (pages 36, 37).

## Troubleshooting—Continued

### The Zone 2 speakers produce no sound

- The Zone 2 speakers only output sources that are connected to an analog input. Check to see if the source is connected to an analog input.

### There's no sound with a certain signal format

- Check the digital audio output setting on the connected device. On some games consoles, such as those that can play DVDs, the default setting is off.
- With some DVD-Video discs, you need to select an audio output format from a menu.

### Can't get 5.1-channel playback

- When the ZONE 2 SPEAKERS terminals are used, playback in the main room is reduced to stereo playback.

### The volume cannot be set to +18 dB (99)

- After the volume level of each speaker has been adjusted (pages 38, 50), the maximum possible volume setting be reduced.

### Noise can be heard

- Using cable ties to bundle audio cables with power cords, speaker cables, and so on may degrade the audio performance, so don't do it.
- An audio cable may be picking up interference. Try repositioning your cables.

### The Late Night function doesn't work

- Make sure the source material is Dolby Digital (page 59).

### The multichannel DVD input doesn't work

- Check the multichannel DVD input connections (page 26).
- To select the multichannel DVD input, press the [Multi CH] input selector button.
- Check the audio output settings on your DVD player.

### About DTS signals

- When playing DTS program material, using the pause, fast forward, or fast reverse function on your player may produce a short audible noise. This is not a malfunction.
- When DTS program material ends and the DTS bitstream stops, the AV receiver remains in DTS listening mode and the DTS indicator remains on. This is to prevent noise when you use the pause, fast forward, or fast reverse function on your player. If you switch your player from DTS to PCM, because the AV receiver does not switch formats immediately, you may not hear any sound, in which case you should stop your player for about 3 seconds, and then resume playback.
- With some CD players, you won't be able to playback DTS material properly even though your player is connected to a digital input on the AV receiver. This is usually because the DTS bitstream has been processed (e.g., output level, sampling rate, or frequency response changed) and the AV receiver doesn't recognize it as a genuine DTS signal. In such cases, you may hear noise.

## Video

### There's no picture

- Make sure that all video connecting plugs are pushed in all the way (page 22).
- Make sure that each video component is properly connected.
- If a video component is connected to a component video input, your TV must be connected to the COMPONENT VIDEO OUT (page 23).
- On your TV, make sure that the video input to which the AV receiver is connected is selected.
- To watch a composite video or S-Video source on a TV that's connected to the COMPONENT VIDEO OUT, select Video in the "Component Video Setup" on page 39.

### The onscreen menus don't appear

- On your TV, make sure that the video input to which the AV receiver is connected is selected.

### The picture is distorted

- With some TVs and projectors, the onscreen setup menus may not appear when the Scan Mode setting is set to Non-Interlaced. In this case, select this setting again by using the AV receiver's display, and select Interlaced (page 63).

### The immediate display does not appear

- The immediate display does not appear on a TV that's connected to the COMPONENT VIDEO OUT.

## Tuner

### Reception is noisy, stereo FM reception suffers from hiss, or the FM STEREO indicator doesn't appear

- Relocate your antenna.
- Move the AV receiver away from your TV or computer.
- Listen to the station in mono (page 43).
- When listening to an AM station, operating the remote controller may cause noise.
- Passing cars and airplanes can cause interference.
- Concrete walls weaken radio signals.
- If nothing improves the reception, install an outdoor antenna.

### Can't select XM radio channels

- Channels cannot be selected while the ► ◀ indicator is flashing, as tuning is in progress.

## Troubleshooting—Continued

### Remote Controller

#### The remote controller doesn't work

- Make sure that the batteries are installed with the correct polarity (page 7).
- Make sure that the remote controller is not too far away from the AV receiver, and that there's no obstruction between the remote controller and the AV receiver's remote control sensor (page 7).
- Make sure you've selected the correct remote controller mode (page 12).
- Make sure you've entered the correct remote control code (page 72).

#### Can't control other components

- Make sure you've selected the correct remote controller mode (page 12).
- If you've connected an **RI**-capable Integra MD recorder, CD recorder, or next generation HDD-compatible component to the TAPE IN/OUT jacks, or an Onkyo DS-A1 Remote Interactive Dock to the VIDEO 3 IN jacks, for the remote controller to work properly, you must set the input display to MD, CDR, or HDD (see page 41).
- The entered remote control code may not be correct. If more than one code is listed, try each one.
- If none of the codes work, use the Learning function to learn the commands of the other component's remote controller (page 75).
- With some AV components, certain buttons may not work as expected, and some may not work at all.
- To control an Integra component that's connected via **RI**, point the remote controller at the AV receiver. Be sure to enter the appropriate remote control code first (page 73).
- To control an Integra component that's not connected via **RI**, or another manufacturer's component, point the remote controller at the component. Be sure to enter the appropriate remote control code first (page 72).

#### Can't learn commands from another remote controller

- When learning commands, make sure that the transmitting ends of both remote controllers are pointing at each other.
- Are you trying to learn from a remote controller that cannot be used for learning? Some commands cannot be learned, especially those that contain several instructions.

### Recording

#### Can't record

- On your recorder, make sure the correct input is selected.
- To prevent signal loops and damage to the AV receiver, input signals are not fed through to outputs with the same name (e.g., TAPE IN to TAPE OUT, VIDEO 1 IN to VIDEO 1 OUT, or VIDEO 2 IN to VIDEO 2 OUT).

### Others

#### The sound changes when I connect my headphones

- When a pair of headphones is connected, the listening mode is set to Stereo, unless it's already set to Stereo, Mono, or Direct, in which case it stays the same.

#### How do I change the language of a multiplex source

- Use the "Multiplex" setting on the "Audio Adjust" menus to select "Main" or "Sub" (page 59).

#### The **RI** functions don't work

- To use **RI**, you must make an **RI** connection and an analog audio connection (RCA) between the component and AV receiver, even if they are connected digitally (page 33).
- While Zone 2 is on, the **RI** functions do not work.

The AV receiver contains a microcomputer for signal processing and control functions. In very rare situations, severe interference, noise from an external source, or static electricity may cause it to lockup. In the unlikely event that this happens, unplug the power cord from the wall outlet, wait at least five seconds, and then plug it back in again.

Onkyo is not responsible for damages (such as CD rental fees) due to unsuccessful recordings caused by the unit's malfunction. Before you record important data, make sure that the material will be recorded correctly.

**To reset the AV receiver to its factory defaults, turn it on and, while holding down the [Video 1] button, press the [Standby/On] button. "Clear" will appear on the display and the AV receiver will enter Standby mode.**

Set the AV receiver to Standby before disconnecting the power cord from the wall outlet.

# Specification

## Amplifier Section

Power Output	
2 channels driven:	<b>90 W + 90 W (8 Ω, 20 Hz–20 kHz, FTC)</b>
Dynamic Power	225 W + 225 W (3 Ω, Front) 170 W + 170 W (4 Ω, Front) 105 W + 105 W (8 Ω, Front)
THD (Total Harmonic Distortion)	0.08% (Power Rated)
Damping Factor	60 (Front, 1 kHz, 8Ω)
Input Sensitivity and Impedance	200 mV/ 47 kΩ (LINE)
Output Level and Impedance	200 mV/ 470 Ω (REC OUT)
Frequency Response	5 Hz–100 kHz/ +1 dB-3 dB (LINE)
Tone Control	±10 dB, 50 Hz (BASS) ±10 dB, 20 kHz (TREBLE)
Signal to Noise Ratio	100 dB (LINE, IHF-A)
Speaker Impedance	6Ω–

## Video Section

Input Sensitivity/Output Level and Impedance	1 Vp-p /75Ω (Component and S-Video Y) 0.7 Vp-p /75Ω (Component Pb/Cb,Pr/Cr) 0.28 Vp-p /75Ω (S-Video C) 1 Vp-p /75Ω (Composite)
Component Video Frequency Response	5 Hz – 50 MHz

## Tuner Section

### ■ FM

Tuning Frequency Range	87.5 MHz– 107.9 MHz
Usable Sensitivity	Stereo: 22.2 dBf (75Ω IHF) Mono: 15.2 dBf (75Ω IHF)
Signal to Noise Ratio	Stereo: 67 dB (IHF-A) Mono: 73 dB (IHF-A)
THD	Stereo: 0.5% (1 kHz) Mono: 0.3% (1 kHz)
Frequency Response	30 Hz–15 kHz / ±1 dB
Stereo Separation	40 dB (1 kHz)

### ■ AM

Tuning Frequency Range	530 kHz–1710 kHz
Usable Sensitivity	300 μV/m
Signal to Noise Ratio	40 dB
THD	0.70%

## General

Power Supply	AC 120 V, 60 Hz
Power Consumption	5.7 A
Standby Power Consumption	0.1 W
Dimensions (W × H × D)	435 × 173.5 × 428.5 mm 17-1/8" × 6-13/16" × 16-7/8"
Weight	11.7 kg 25.8 lbs.
<b>■ Video Inputs</b>	
Component	IN1, IN2, IN3
S-Video	DVD, VIDEO1, VIDEO2, VIDEO3
Composite	DVD, VIDEO1, VIDEO2, VIDEO3

### ■ Video Outputs

Component	OUT
S-Video	MONITOR OUT, VIDEO1, VIDEO2
Composite	MONITOR OUT, VIDEO1, VIDEO2

### ■ Audio Inputs

Digital Inputs	Optical: 3 Coaxial: 2
Analog Inputs	DVD (MULTICHANNEL), VIDEO1, VIDEO2, VIDEO3, TAPE, CD
Multichannel Input	5.1 ch (DVD)

### ■ Audio Outputs

Digital Output	Optical: 1
Analog Outputs	TAPE, VIDEO1, VIDEO2, ZONE2 L/R
Subwoofer Pre Outputs	1
Speaker Outputs	L, R, C, SL, SR ZONE2 (L, R)
Phones	1
RS232	1
IR Input/Output	2/1
12 V Trigger Out	A, B, C

Specifications and features are subject to change without notice.

Integra Division of  
**ONKYO U.S.A. CORPORATION**  
18 park Way, Upper Saddle River, N.J. 07458, U.S.A.  
Tel: 201-785-2600 Fax: 201-785-2650 <http://www.integrathometheater.com>

Integra Division of  
**ONKYO CORPORATION**  
Sales & Product Planning Div.: 2-1, Nisshin-cho, Neyagawa-shi, OSAKA 572-8540, JAPAN  
Tel: 072-831-8023 Fax: 072-831-8124



I0509-1

SN 29344083

(C) Copyright 2005 ONKYO CORPORATION Japan. All rights reserved.



\* 2 9 3 4 4 0 8 3 \*



## Free Manuals Download Website

<http://myh66.com>

<http://usermanuals.us>

<http://www.somanuals.com>

<http://www.4manuals.cc>

<http://www.manual-lib.com>

<http://www.404manual.com>

<http://www.luxmanual.com>

<http://aubethermostatmanual.com>

Golf course search by state

<http://golfingnear.com>

Email search by domain

<http://emailbydomain.com>

Auto manuals search

<http://auto.somanuals.com>

TV manuals search

<http://tv.somanuals.com>