

AV Receiver

DTR-6.5/5.5

Instruction Manual

Integra

WARNING:

TO REDUCE THE RISK OF FIRE OR ELECTRIC SHOCK, DO NOT EXPOSE THIS APPARATUS TO RAIN OR MOISTURE.

CAUTION:

TO REDUCE THE RISK OF ELECTRIC SHOCK, DO NOT REMOVE COVER (OR BACK). NO USER-SERVICEABLE PARTS INSIDE. REFER SERVICING TO QUALIFIED SERVICE PERSONNEL.



WARNING
RISK OF ELECTRIC SHOCK
DO NOT OPEN

AVIS
RISQUE DE CHOC ELECTRIQUE
NE PAS OUVRIR



The lightning flash with arrowhead symbol, within an equilateral triangle, is intended to alert the user to the presence of uninsulated "dangerous voltage" within the product's enclosure that may be of sufficient magnitude to constitute a risk of electric shock to persons.



The exclamation point within an equilateral triangle is intended to alert the user to the presence of important operating and maintenance (servicing) instructions in the literature accompanying the appliance.

Important Safety Instructions

1. Read these instructions.
2. Keep these instructions.
3. Heed all warnings.
4. Follow all instructions.
5. Do not use this apparatus near water.
6. Clean only with dry cloth.
7. Do not block any ventilation openings. Install in accordance with the manufacturer's instructions.
8. Do not install near any heat sources such as radiators, heat registers, stoves, or other apparatus (including amplifiers) that produce heat.
9. Do not defeat the safety purpose of the polarized or grounding-type plug. A polarized plug has two blades with one wider than the other. A grounding type plug has two blades and a third grounding prong. The wide blade or the third prong are provided for your safety. If the provided plug does not fit into your outlet, consult an electrician for replacement of the obsolete outlet.
10. Protect the power cord from being walked on or pinched particularly at plugs, convenience receptacles, and the point where they exit from the apparatus.
11. Only use attachments/accessories specified by the manufacturer.
12. Use only with the cart, stand, tripod, bracket, or table specified by the manufacturer, or sold with the apparatus. When a cart is used, use caution when moving the cart/apparatus combination to avoid injury from tip-over.

PORTABLE CART WARNING



S3125A
13. Unplug this apparatus during lightning storms or when unused for long periods of time.
14. Refer all servicing to qualified service personnel. Servicing is required when the apparatus has been damaged in any way, such as power-supply cord or plug is damaged, liquid has been spilled or objects have fallen into the apparatus, the apparatus has been exposed to rain or moisture, does not operate normally, or has been dropped.
15. Damage Requiring Service

Unplug the apparatus from the wall outlet and refer servicing to qualified service personnel under the following conditions:

 - A. When the power-supply cord or plug is damaged,
 - B. If liquid has been spilled, or objects have fallen into the apparatus,
 - C. If the apparatus has been exposed to rain or water,
 - D. If the apparatus does not operate normally by following the operating instructions. Adjust only those controls that are covered by the operating instructions as an improper adjustment of other controls may result in damage and will often require extensive work by a qualified technician to restore the apparatus to its normal operation,
 - E. If the apparatus has been dropped or damaged in any way, and
 - F. When the apparatus exhibits a distinct change in performance this indicates a need for service.
16. Object and Liquid Entry

Never push objects of any kind into the apparatus through openings as they may touch dangerous voltage points or short-out parts that could result in a fire or electric shock.

The apparatus shall not be exposed to dripping or splashing and no objects filled with liquids, such as vases shall be placed on the apparatus.

Don't put candles or other burning objects on top of this unit.
17. Batteries

Always consider the environmental issues and follow local regulations when disposing of batteries.
18. If you install the apparatus in a built-in installation, such as a bookcase or rack, ensure that there is adequate ventilation.

Leave 20 cm (8") of free space at the top and sides and 10 cm (4") at the rear. The rear edge of the shelf or board above the apparatus shall be set 10 cm (4") away from the rear panel or wall, creating a flue-like gap for warm air to escape.

Precautions

For U.S. Models

Note to CATV system installer:

This reminder is provided to call the CATV system installer's attention to Section 820-40 of the NEC which provides guidelines for proper grounding and, in particular, specifies that the cable ground shall be connected to the grounding system of the building, as close to the point of cable entry as practical.

FCC Information for User

CAUTION:

The user changes or modifications not expressly approved by the party responsible for compliance could void the user's authority to operate the equipment.

NOTE:

This equipment has been tested and found to comply with the limits for a Class B digital device, pursuant to Part 15 of the FCC Rules.

These limits are designed to provide reasonable protection against harmful interference in a residential installation. This equipment generates, uses and can radiate radio frequency energy and, if not installed and used in accordance with the instructions, may cause harmful interference to radio communications. However, there is no guarantee that interference will not occur in a particular installation.

If this equipment does cause harmful interference to radio or television reception, which can be determined by turning the equipment off and on, the user is encouraged to try to correct the interference by one or more of the following measures:

- Reorient or relocate the receiving antenna.
- Increase the separation between the equipment and receiver.
- Connect the equipment into an outlet on a circuit different from that to which the receiver is connected.
- Consult the dealer or an experienced radio/TV technician for help.

For Canadian model

NOTE: THIS CLASS B DIGITAL APPARATUS COMPLIES WITH CANADIAN ICES-003.

For models having a power cord with a polarized plug:

CAUTION: TO PREVENT ELECTRIC SHOCK, MATCH WIDE BLADE OF PLUG TO WIDE SLOT, FULLY INSERT.

Modèle pour les Canadien

REMARQUE: CET APPAREIL NUMÉRIQUE DE LA CLASSE B EST CONFORME À LA NORME NMB-003 DU CANADA.

Sur les modèles dont la fiche est polarisée:

ATTENTION: POUR ÉVITER LES CHOCS ÉLECTRIQUES, INTRODUIRE LA LAME LA PLUS LARGE DE LA FICHE DANS LA BORNE CORRESPONDANTE DE LA PRISE ET POUSSER JUSQU'AU FOND.

1. **Recording Copyright**—Unless it's for personal use only, recording copyrighted material is illegal without permission of the copyright holder.
2. **AC Fuse**— The AC fuse inside the AV receiver is not user-serviceable. If you cannot turn on the AV receiver, have it checked by the dealer from whom you purchased this unit.
3. **Care**—Occasionally you should dust the AV receiver all over with a soft cloth. For stubborn stains, use a soft cloth dampened with a weak solution of mild detergent and water. Dry the AV receiver immediately afterwards with a clean cloth. Don't use abrasive cloths, thinners, alcohol, or other chemical solvents, because they may damage the finish or remove the panel lettering.

4. Power

WARNING

BEFORE PLUGGING IN THE UNIT FOR THE FIRST TIME, READ THE FOLLOWING SECTION CAREFULLY.

AC outlet voltages vary from country to country. Make sure that the voltage in your area meets the voltage requirements printed on the AV receiver's rear panel (e.g., AC 230 V, 50 Hz or AC 120 V, 60 Hz).

Setting the [Standby/On] switch to Standby does not fully shutdown the AV receiver. If you do not intend to use the AV receiver for an extended period, remove the power cord from the wall outlet.

Thank you for purchasing an Integra AV Receiver. Please read this manual thoroughly before making any connections and plugging it in. Following the instructions in this manual will enable you to obtain optimum performance and listening enjoyment from your new AV Receiver. Please retain this manual for future reference.

Precautions—Continued

For British models

Replacement and mounting of an AC plug on the power supply cord of this unit should be performed only by qualified service personnel.

IMPORTANT

The wires in the mains lead are coloured in accordance with the following code:

Blue: Neutral
Brown: Live

As the colours of the wires in the mains lead of this apparatus may not correspond with the coloured markings identifying the terminals in your plug, proceed as follows:

The wire which is coloured blue must be connected to the terminal which is marked with the letter N or coloured black.

The wire which is coloured brown must be connected to the terminal which is marked with the letter L or coloured red.

IMPORTANT

A 5 or 13 ampere fuse is fitted in this plug. Should the fuse need to be replaced, please ensure that the replacement fuse has a rating of 5 or 13 amperes and that it is approved by ASTA or BSI to BS1362. Check for the ASTA mark or the BSI mark on the body of the fuse. IF THE FITTED MOULDED PLUG IS UNSUITABLE FOR THE SOCKET OUTLET IN YOUR HOME THEN THE FUSE SHOULD BE REMOVED AND THE PLUG CUT OFF AND DISPOSED OF SAFELY. THERE IS A DANGER OF SEVERE ELECTRICAL SHOCK IF THE CUT OFF PLUG IS INSERTED INTO ANY 13 AMPERE SOCKET.

If in any doubt, consult a qualified electrician.

For European Models

Declaration of Conformity

We, ONKYO EUROPE
ELECTRONICS GmbH
LIEGNITZERSTRASSE 6,
82194 GROEBENZELL,
GERMANY



declare in own responsibility, that the ONKYO product described in this instruction manual is in compliance with the corresponding technical standards such as EN60065, EN55013, EN55020 and EN61000-3-2, -3-3.

GROEBENZELL, GERMANY

I. MORI

ONKYO EUROPE ELECTRONICS GmbH

Supplied Accessories

Make sure you have the following accessories:

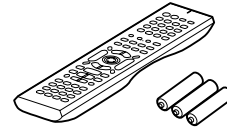

Remote controller & three batteries (AA/R6)

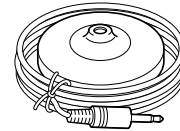

Speaker setup microphone

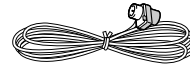

Indoor FM antenna

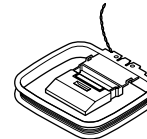

AM loop antenna

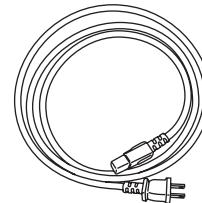

Power cord
(Plug type varies from country to country.)

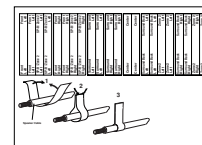

Speaker cable labels

* In catalogs and on packaging, the letter at the end of the product name indicates the color. Specifications and operation are the same regardless of color.

Features

DTR-6.5/5.5

Amplifier

- 7-channel amplifier
- Optimum Gain Volume Circuitry
- Zone 2 capability
- 24-bit/192 kHz D/A converters
- WRAT (Wide Range Amplifier Technology)
- Color-coded speaker terminal posts

Audio/Video

- Dolby^{*1} Digital, Dolby Digital EX, Dolby Pro Logic IIx
- DTS^{*2}, DTS-ES Discrete, DTS-ES Matrix, DTS Neo:6, and DTS 96/24
- Theater-Dimensional^{*3} virtual surround mode
- VLSC (Vector Linear Shaping Circuitry) on all channels
- Zone 2 out
- Composite video to S-Video and S-Video to composite video conversion
- Composite and S-Video to component video conversion
- 3 component video inputs, 1 output
- 5 S-Video inputs, 3 outputs

FM/AM Tuner

- 40 AM/FM presets
- AM/FM auto tuning

Others

- Includes microphone for automatic speaker setup
- Easy-to-use onscreen setup menus
- Preprogrammed remote controller for use with other AV components

*1. Manufactured under license from Dolby Laboratories. "Dolby", "Pro Logic", "Surround EX", and the double-D symbol are trademarks of Dolby Laboratories.

*2. "DTS", "DTS 96/24", "DTS-ES", and "Neo:6" are trademarks of Digital Theater Systems, Inc.

*3. "Theater-Dimensional" is a trademark of Onkyo Corporation.

DTR-6.5

Amplifier

- 100 watts per channel into 8 ohms, 20 Hz to 20 kHz, less than 0.08% total harmonic distortion (FTC rating)

Audio/Video

- THX^{*4} Surround EX
- THX Select certified
- Re-EQ
- Pre outs for front L/R, center, surround L/R, surround back L/R, and subwoofer
- 7 digital inputs (5 optical, 2 coaxial), 2 digital outputs (1 optical, 1 coaxial)

THX Select

Before any home theater component can be THX Select certified, it must pass a rigorous series of quality and performance tests. Only then can a product feature the THX Select logo, which is your guarantee that the Home Theater products you purchase will give you superb performance for many years to come. THX Select requirements define hundreds of parameters, including power amplifier performance, and pre-amplifier performance and operation for both digital and analog domains. THX Select receivers also feature proprietary THX technologies (e.g., THX Mode) which accurately translate movie soundtracks for home theater playback.

DTR-5.5

Amplifier

- 85 watts per channel into 8 ohms, 20 Hz to 20 kHz, less than 0.08% total harmonic distortion (FTC rating)

Audio/Video

- CinemaFILTER^{*5}
- Subwoofer pre out
- 6 digital inputs (4 optical, 2 coaxial), 1 digital optical output.

*4. "THX" is a trademark or registered trademark of THX Ltd. "Surround EX" is a trademark of Dolby Laboratories. Used under authorization. All rights reserved.

*5. "CinemaFILTER" is a trademark of Onkyo Corporation. "Xantech" is a registered trademark of Xantech Corporation. "Niles" is a registered trademark of Niles Audio Corporation.

Table of Contents

Basic

Introduction

Important Safety Instructions	2
Precautions	3
Supplied Accessories.....	4
Features	5
Table of Contents.....	6
Front & Rear Panels.....	8
Remote Controller.....	13
About Home Theater	20

Connecting the AV receiver

About AV Connections	21
Connecting Your Speakers.....	22
Connecting Antenna.....	24
Connecting Both Audio & Video.....	26
Which Connections Should I Use?	26
Connecting Your TV or Projector	27
Connecting AV components	28
Connecting Audio components.....	34
Connecting a Power Amplifier (DTR-6.5 only).....	37
Connecting $\overline{\text{R}}\text{I}$ Components.....	37
Connecting the Power Cords of Other Components.....	38
Connecting the Supplied Power Cord.....	38
Turning On the AV receiver	38

First Time Setup

Automatic Speaker Setup.....	39
About the Onscreen Setup Menus	41
Initial Setup.....	42
Digital Input	42
Component Video Setup	43
Minimum Speaker Impedance (not American models)	44
TV Format Setup (not American models).....	45
Speaker Setup	46
Changing the TAPE/MD/CDR Display	52

Basic Operation

Selecting the Input Source.....	53
Setting the Display Brightness	54
Muting the AV receiver	54
Using the Sleep Timer.....	54
Using Headphones	54
Displaying Source Information	55
Using the Tuner	56
Selecting Listening Modes.....	58
Listening mode table	59
About the Listening Modes.....	60

Others

Troubleshooting	90
Specifications.....	94

Table of Contents—Continued

Advanced

Introduction 2

Connections 21

First Setup 39

Basic Operation 53

Advanced Operation 62

Advanced Setup 66

Zone 2 74

Using the Remote Controller
with Other Components 80

Troubleshooting 90

Others..... 94

Controlling Other Components

Advanced
Features

Entering a Remote Control Codes.....	80
Learning Commands from Another Remote Controller	88
Using Macros.....	89

Advanced Setup

Advanced
Features

Decoder Setup.....	66
Adjusting the Bass & Treble.....	68
Audio Adjust Functions.....	68
Assigning Listening Modes to Input Sources	70
Setting Preferences	71
Changing the Remote Controller's ID	73

Advanced Operation

Advanced
Features

Using the Late Night Function (Dolby Digital only)	62
Using the Re-EQ Function (DTR-6.5 only)	62
Using the CinemaFILTER (TDR-5.5 only)	62
Adjusting Individual Speaker Levels.....	63
Using the DVD Analog Multichannel Input	63
Recording	64

Zone 2

Advanced
Features

Connecting Zone 2.....	74
Setting the Powered Zone 2	75
Setting the zone 2 OUT.....	76
Using Zone 2.....	77
Using the Remote Control in Zone 2	79

Front & Rear Panels

Front Panel

DTR-6.5

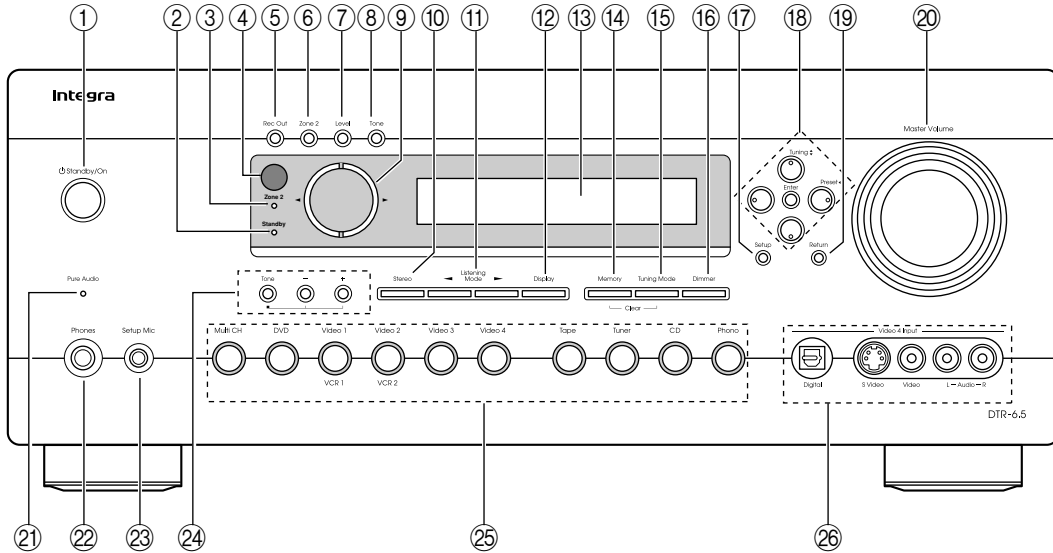

DTR-5.5

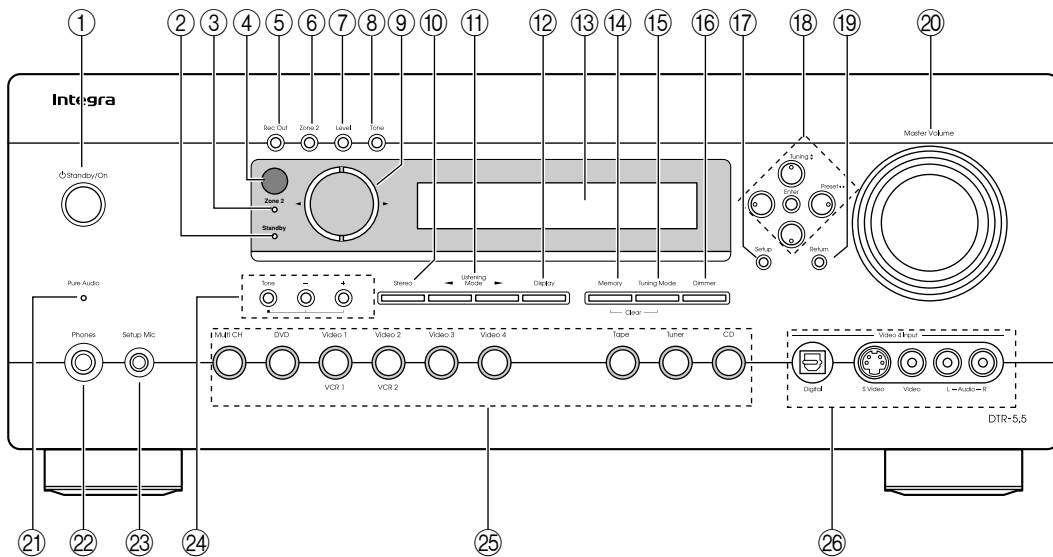

Front & Rear Panels—Continued

For detailed information, see the pages in parentheses.

- ① **Standby/On button (38)**
This button is used to set the AV receiver to On or Standby. For models with a POWER switch, this button has no effect unless the POWER switch is set to ON.
- ② **Standby indicator (38)**
This indicator lights up when the AV receiver is in Standby mode, and it flashes while a signal is being received from the remote controller.
- ③ **Zone 2 indicator (77)**
This indicator lights up when Zone 2 is selected.
- ④ **Remote-control sensor (13)**
This sensor receives control signals from the remote controller.
- ⑤ **Rec Out button (64)**
This button is used to select the input source to be recorded.
- ⑥ **Zone 2 button (77)**
This button is used to select the input source for Zone 2.
- ⑦ **Level button (77)**
This button is used to set the volume for Zone 2.
- ⑧ **Tone button (78)**
This button is used to adjust the bass and treble for Zone 2.
- ⑨ **Controller [◀] [▶] buttons (64, 77, 78)**
These buttons are used to select the input source to be recorded via the REC OUTs, to select the input source for Zone 2, and to set the volume, bass, and treble for Zone 2.
- ⑩ **Stereo button (58)**
This button is used to select the Stereo listening mode.
- ⑪ **Listening Mode [◀] [▶] buttons (58)**
These buttons are used to select the listening modes.
- ⑫ **Display button (55)**
This button is used to display various information about the currently selected input source.
- ⑬ **Display**
See "Display" on page 10.
- ⑭ **Memory button (57)**
This button is used when storing or deleting radio presets.
- ⑮ **Tuning Mode button (56)**
This button is used to select the Auto or Manual tuning mode.
- ⑯ **Dimmer button (54)**
This button is used to adjust the display brightness.
- ⑰ **Setup button (42)**
This button is used to access the onscreen setup menus that appear on the connected TV.
- ⑱ **Arrow/Tuning/Preset & Enter buttons (42)**
When the AM or FM input source is selected, the Tuning [▲] [▼] buttons are used to tune the tuner, and the Preset [◀] [▶] buttons are used to select radio presets (see page 57). When the onscreen setup menus are used, they work as arrow buttons and are used to select and set items. The Enter button is also used with the onscreen setup menus.
- ⑲ **Return button**
This button is used to return to the previously displayed onscreen setup menu.
- ⑳ **Master Volume control (53)**
This control is used to adjust the volume of the AV receiver to MIN, 1 through 99, or MAX.
- ㉑ **Pure Audio indicator (58)**
This indicator lights up when the Pure Audio listening mode is selected.
- ㉒ **Phones jack (54)**
This 1/4-inch phone jack is for connecting a standard pair of stereo headphones for private listening.
- ㉓ **Setup Mic (39)**
The included speaker setup microphone is connected here for automatic speaker setup.
- ㉔ **Tone, [-] & [+] buttons (78)**
These buttons are used to adjust the bass and treble.
- ㉕ **Input selector buttons (53)**
These buttons are used to select from the following input sources: Multi CH, DVD, VIDEO 1, VIDEO 2, VIDEO 3, VIDEO 4, TAPE, TUNER, CD, or PHONO (DTR-6.5 only).
The [Multi CH] button selects the DVD analog multichannel input.
- ㉖ **Video 4 Input (33, 65)**
This input can be used to connect a camcorder, games console, and so on. There are jacks for optical digital audio, S-Video, composite video, and analog audio.

Front & Rear Panels—Continued

Display

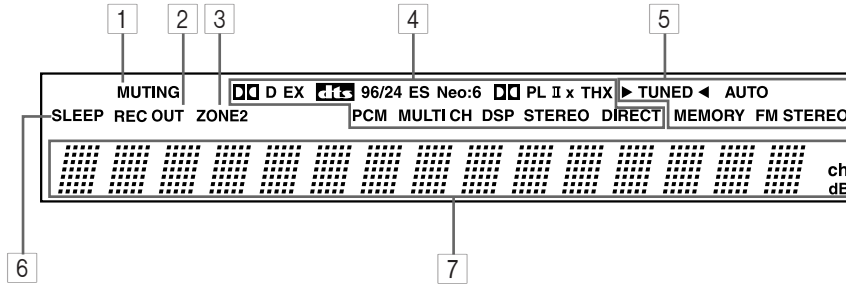

For detailed information, see the pages in parentheses.

1 MUTING indicator (54)

This indicator flashes while the AV receiver is muted.

2 REC OUT indicator (64)

This indicator lights up when the REC OUT is selected.

3 ZONE 2 indicator (77)

This indicator lights up when Zone 2 is selected.

4 Listening mode & format indicators

These indicators show the currently selected listening mode and the format of digital input signals.

5 Tuning indicators (56)

TUNED: This indicator lights up when the AV receiver is tuned into a radio station.

AUTO: This indicator lights up when the Auto Tuning mode is selected, and disappears when the Manual Tuning mode is selected.

MEMORY: This indicator lights up when presetting radio stations.

FM STEREO: This indicator lights up when the AV receiver is tuned to a stereo FM station.

6 SLEEP indicator (54)

This indicator lights up when the Sleep function has been set.

7 Message area

This area of the display shows various information about the currently selected source.

Rear Panel

DTR-6.5

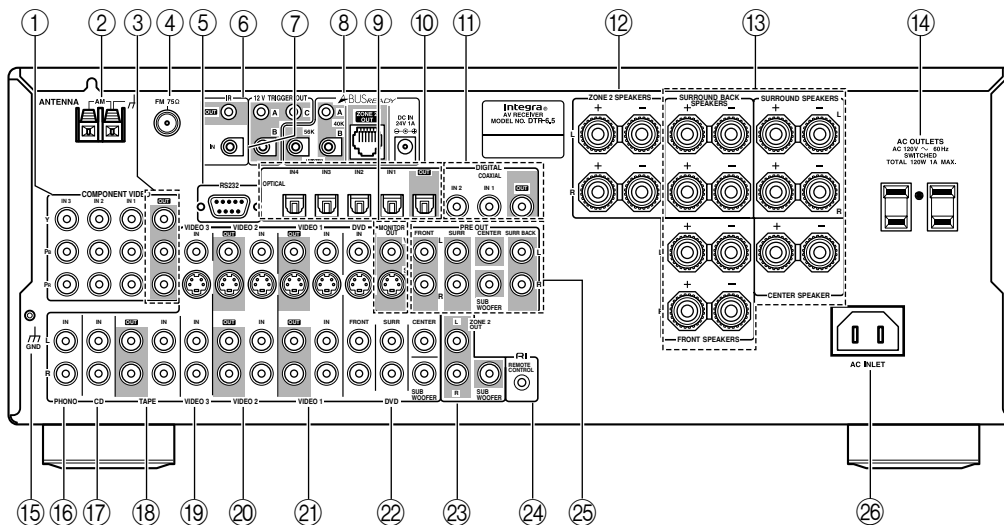

Front & Rear Panels—Continued

DTR-5.5

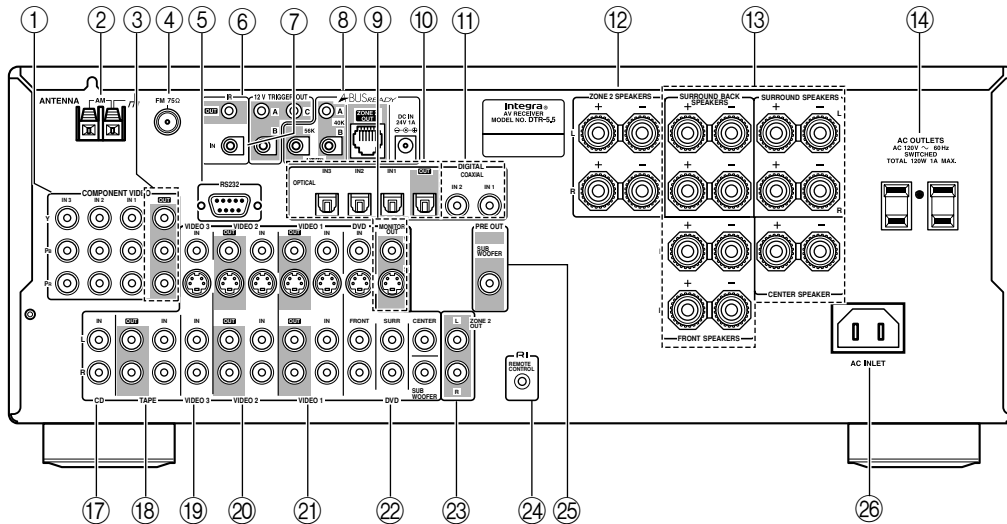

For detailed information, see the pages in parentheses.

- ① **COMPONENT VIDEO IN 1, 2, 3 (28, 30, 32)**
These component video inputs can be used to connect AV components with component video outputs, such as DVD players.
- ② **AM ANTENNA (24)**
These push terminals are for connecting an AM antenna.
- ③ **COMPONENT VIDEO OUT (27)**
This component video output can be used to connect a TV or projector with a component video input.
- ④ **FM ANTENNA (24)**
This jack is for connecting an FM antenna.
- ⑤ **RS232 (38)**
This port is for connecting the AV receiver to home automation equipment and external controllers.
- ⑥ **12V TRIGGER OUT A/B/C (73, 78)**
These jacks can be connected to the 12-volt trigger inputs on other components. These trigger outputs can each be assigned to an input so that when that input is selected, a 12-volt trigger signal is output.
- ⑦ **IR IN/OUT (78)**
These jacks are for connecting the remote sensors included with multiroom kits (sold separately).
- ⑧ **A-BUS**
A-BUS is a simple, efficient, elegant audio distribution system. The wiring installation time is significantly reduced as only a single CAT-5 wire is run to each location. A-BUS is easy to use, reliable, affordable, and most of all, far better sounding than conventional auto former based volume controls.

ZONE 2 OUT: Use CAT-5 (eight conductor twisted) cable to connect directly from the receiver's A-BUS Hub to an A-BUS keypad.

Warning:
DO NOT connect A-BUS output to any computer or network connections (i.e. ethernet). It will cause damage to the computer or network components as 24-volt power runs on this same cable to power the amplifier stages of the amplifier module.

IR OUT: Another feature of the A-BUS system is the ability to control source equipment in another room where the A-BUS module is installed. If you wish to control another source from the receiver at the A-BUS keypad by remote control, connect A-BUS or another brand's IR emitter on the receiver's 40 K terminal. Then place the emitter on the remote receiver on the front panel. Typically, the emitter will work when you connect with a 40 K connector. If it does not work, try a 56 K connector.

DC IN: Connect A-Bus power supply. Do not use any other AC Adapter on this connector as it may cause severe damage to the receiver.

- ⑨ **MONITOR OUT (27)**
The S-Video or composite video jack should be connected to a video input on your TV or projector.

Front & Rear Panels—Continued

⑩ OPTICAL DIGITAL (27, 28, 30, 32, 34, 35)

The DTR-5.5 doesn't have an IN 4 jack.

The optical digital audio inputs can be used to connect CD and DVD players, and other components with an optical digital audio output.

The optical output can be used to connect a CD recorder or other digital recorder with an optical digital input.

⑪ COAXIAL DIGITAL (27, 28, 30, 32, 34, 35)

The coaxial digital audio inputs can be used to connect CD and DVD players, and other components with a coaxial digital audio output.

The coaxial output can be used to connect a CD recorder or other digital recorder with a coaxial digital input.

The DTR-5.5 do not have a coaxial output.

⑫ ZONE 2 SPEAKERS (74)

These terminal posts are for connecting speakers in Zone 2.

⑬ FRONT, CENTER, SURROUND & SURROUND BACK SPEAKERS (23)

These terminal posts are for connecting your front, center, surround, and surround back speakers.

⑭ AC OUTLETS (38)

These switched AC outlets can be used to supply power to other AV components. The type of outlet depends on the country in which you purchased your AV receiver. Some models have a single outlet.

⑮ Grounding screw (DTR-6.5 only) (36)

This screw is for connecting a turntable's ground wire.

⑯ PHONO IN (DTR-6.5 only) (36)

This analog input is for connecting a turntable.

⑰ CD IN (34)

This analog audio input is for connecting a CD player's analog audio output.

⑱ TAPE IN/OUT (34)

This analog audio input and output are for connecting a recorder with an analog audio input and output (cassette, Mini Disc, etc).

⑲ VIDEO 3 IN (27, 31)

Here you can connect a video source (VCR, set-top box, etc). Input jacks include S-Video, composite video, and analog audio.

⑳ VIDEO 2 IN/OUT (30, 31)

Here you can connect a VCR. Input and output jacks include S-Video, composite video, and analog audio.

㉑ VIDEO 1 IN/OUT (30, 31)

Here you can connect a VCR. Input and output jacks include S-Video, composite video, and analog audio.

㉒ DVD IN (28, 29)

Here you can connect a DVD player. Input jacks include S-Video, composite video, and analog audio. You can connect a DVD player's 2-channel analog audio output or 5.1-channel analog audio output.

㉓ ZONE 2 OUT (74)

This analog audio output can be connected to a line input on an integrated amplifier in Zone 2.

The DTR-6.5 also has a ZONE 2 OUT SUB-WOOFER jack that can be used to feed a subwoofer in Zone 2.

These jacks can be configured as either line outs or pre outs on the onscreen setup menus.

㉔ RI REMOTE CONTROL (37)

This **RI** (Remote Interactive) jack can be connected to an **RI** jack on another Integra AV component. The AV receiver's remote controller can then be used to control that component. To use **RI**, you must make an analog audio connection (RCA) between the AV receiver and the other AV component, even if they are connected digitally.

㉕ PRE OUT (37)

These analog audio outputs are for connecting a separate power amplifier. Useful if you want to connect a more powerful amplifier and use the AV receiver as a preamp. The SUBWOOFER jack is for connecting a powered subwoofer.

㉖ AC INLET (38)

The supplied power cord should be connected here.

Remote Controller

Installing the Batteries

- 1** To open the battery compartment, press the small hollow and slide off the cover.

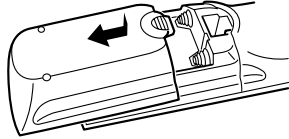

- 2** Insert the three supplied batteries (AA/R6) in accordance with the polarity diagram inside the battery compartment.

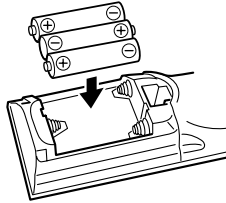

- 3** Put the cover onto the remote controller and slide it shut.

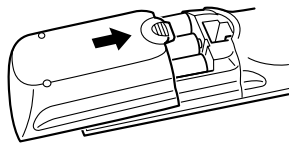

Notes:

- The batteries should last for about six months, although this will vary with usage.
- If the remote controller doesn't work reliably, try replacing the batteries.
- Don't mix new and old batteries or different types of batteries.
- If you intend not to use the remote controller for a long time, remove the batteries to prevent damage from leakage or corrosion.
- Expired batteries should be removed as soon as possible to prevent damage from leakage or corrosion.

Using the Remote Controller

To use the remote controller, point it at the AV receiver's remote control sensor, as shown below.

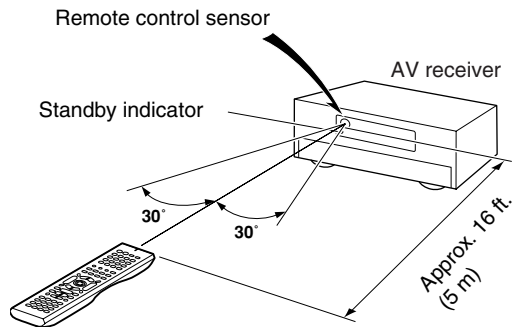

Notes:

- The remote controller may not work reliably if the AV receiver is subjected to bright light, such as direct sunlight or inverter-type fluorescent lights. Keep this in mind when installing.
- If another remote controller of the same type is used in the same room, or the AV receiver is installed close to equipment that uses infrared rays, the remote controller may not work reliably.
- Don't put anything, such as a book, on the remote controller, because the buttons may be pressed inadvertently, thereby draining the batteries.
- The remote controller may not work reliably if the AV receiver is installed in a rack behind colored glass doors. Keep this in mind when installing.
- The remote controller will not work if there's an obstacle between it and the AV receiver's remote control sensor.

Remote Controller—Continued

In addition to controlling the AV receiver, the remote controller has several operating modes for controlling your other AV components, including Integra components connected via **RI**. Modes are selected by using the remote controller's Remote Mode buttons.

For detailed information, see the pages in parentheses. Some of the functions described in this manual may not work as expected with other components.

Receiver Mode

Receiver mode is used to control the AV receiver. To select Receiver mode, press the [Receiver] Remote Mode button.

RC-585M

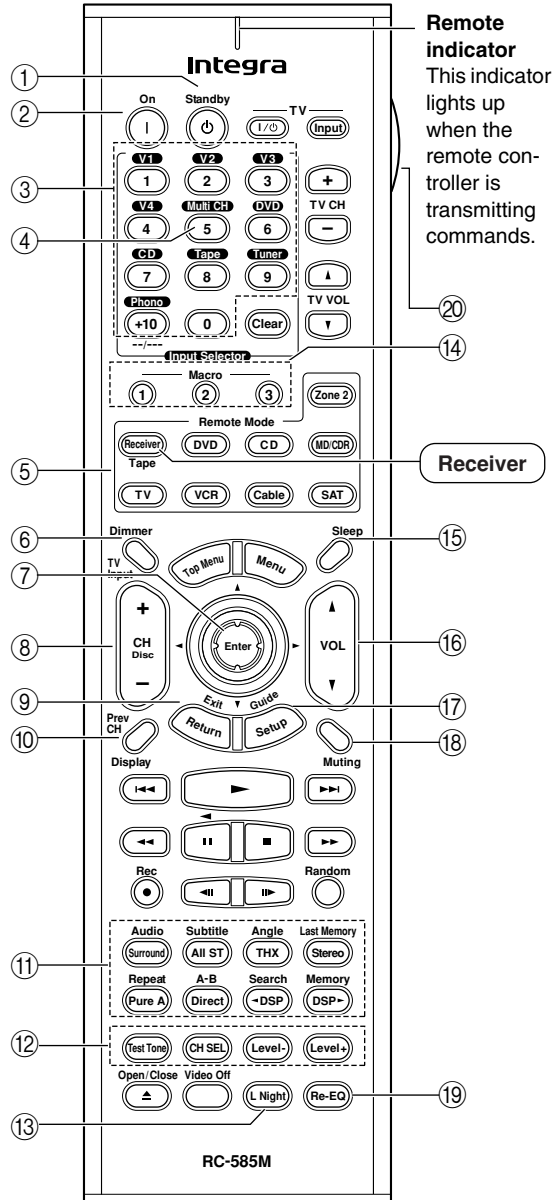

Remote Controller—Continued

RC-586M

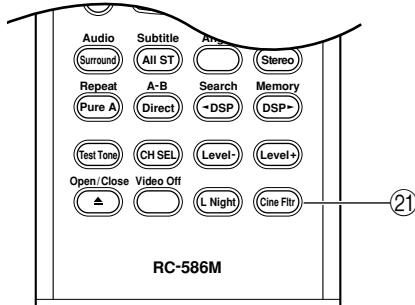

① Standby button (38)

This button is used to set the AV receiver to Standby.

② On button (38)

This button is used to turn on the AV receiver.

③ Input Selector buttons (53)

These buttons are used to select the input source. Only the RC-588M has a [PHONO] button.

④ Multi CH button (63)

This button is used to select the DVD analog multi-channel input.

⑤ Remote Mode buttons

These buttons are used to select the remote controller modes.

⑥ Dimmer button (54)

This button is used to adjust the display brightness.

⑦ Arrow [▲]/[▼]/[◀]/[▶] & Enter buttons (42)

These buttons are used to select items on the onscreen setup menus.

⑧ CH +/- button (57)

This button is used to select radio presets.

⑨ Return button

This button is used to return to the previously displayed onscreen setup menu.

⑩ Display button (55, 57)

This button is used to display various information about the currently selected input source.

⑪ Listening mode buttons (58)

Surround button

This button is used to select the Dolby Digital, Pro Logic IIx, Neo:6, DTS and other listening modes.

All ST button

This button is used to select the All Ch Stereo listening mode.

THX button (RC-585M only)

This button is used to select the THX listening modes.

Stereo button

This button is used to select the Stereo listening mode.

Pure A button

This button is used to select the Pure Audio listening mode.

Direct button

This button is used to select the Direct listening mode.

[◀ DSP] & [DSP ▶] buttons

These buttons are used to select the Onkyo original DSP (digital signal processor) listening modes.

⑫ Test Tone, CH SEL, Level- & Level+ buttons (50)

These buttons are used to adjust the level of each speaker individually. The [Level-] & [Level+] buttons are also used to adjust the volume in Zone 2.

⑬ L Night button (62)

This button is used to set the Late Night function.

⑭ Macro buttons (89)

These buttons are used with the Macro function.

⑮ Sleep button (54)

This button is used to set the Sleep function.

⑯ VOL button (53)

This button is used to adjust the volume of the AV receiver.

⑰ Setup button (42)

This button is used to access the onscreen setup menus that appear on the connected TV.

⑱ Muting button (54)

This button is used to mute the AV receiver.

⑲ Re-EQ button (RC-585M only) (62)

This button is used to turn the Re-EQ function on and off.

⑳ Light button

This button is used to turn on or off the remote controller's illuminated buttons.

㉑ Cine Filtr button (RC-586M only) (62)

This button is used to set the CinemaFILTER function.

Remote Controller—Continued

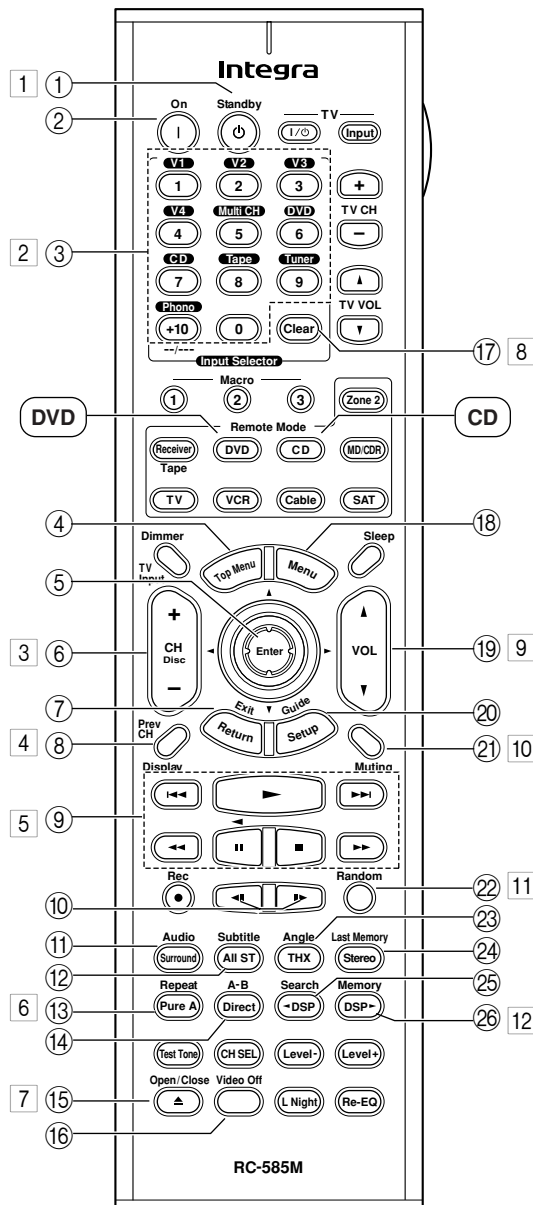

Round numbers are for DVD mode.
Square numbers are for CD mode.

DVD Mode

DVD mode is used to control an Integra DVD player connected to the AV receiver via **RI**.

To set the remote controller to DVD mode, press the [DVD] Remote Mode button.

- ① **Standby button**
This button is used to set the DVD player to Standby.
- ② **On button**
This button is used to turn on the DVD player and to set it to Standby.
- ③ **Number buttons**
These buttons are used to enter title, chapter, and track numbers, and to enter times for locating specific points in time.
- ④ **Top Menu button**
This button is used to select a DVD's top menu.
- ⑤ **Arrow [▲]/[▼]/[◀]/[▶] & Enter buttons**
These buttons are used to navigate DVD menus and the DVD player's onscreen setup menus.
- ⑥ **Disc +/- button**
This button selects discs on a DVD changer.
- ⑦ **Return/Exit button**
This button is used to exit the DVD player's onscreen setup menu.
- ⑧ **Display button**
This button is used to display information about the current disc, title, chapter, or track on the DVD player's display, including the elapsed time, remaining time, total time, and so on.
- ⑨ **Playback buttons**
From left to right: Previous, Play, Next, Fast Reverse, Pause, Stop, and Fast Forward.
- ⑩ **Step & Slow [◀◀]/[▶▶] buttons**
These buttons are used for frame-by-frame playback and slow-motion playback.
- ⑪ **Audio button**
This button is used to select foreign language soundtracks and audio formats (e.g., Dolby Digital or DTS).
- ⑫ **Subtitle button**
This button is used to select subtitles.
- ⑬ **Repeat button**
This button is used to set the repeat playback functions.

Remote Controller—Continued

- ⑭ **A-B button**
This button is used to set the A–B repeat playback function.
- ⑮ **Open/Close [▲] button**
This button is used to open and close the disc tray.
- ⑯ **Video Off button**
This button is used to turn off the internal video circuitry, eliminating any possibility of interference.
- ⑰ **Clear button**
This button is used to cancel functions and to clear entered numbers.
- ⑱ **Menu button**
This button is used to display a DVD's menu.
- ⑲ **VOL button**
This button is used to adjust the volume of the AV receiver.
- ⑳ **Setup/Guide button**
This button is used to access the DVD player's onscreen setup menus.
- ㉑ **Muting button**
This button is used to mute the AV receiver.
- ㉒ **Random button**
This button is used with the random playback function.
- ㉓ **Angle button**
This button is used to select camera angles.
- ㉔ **Last M button**
This button is used with the last memory function, which allows you to resume DVD playback from where you left off.
- ㉕ **Search button**
This button is used to search for titles, chapters, tracks, and specific points in time.
- ㉖ **Memory button**
This button is used with the memory playback function, which allows you to create a custom playlist of titles, chapters, or tracks.

CD Mode

CD mode is used to control an Integra CD player connected to the AV receiver via **RI**.

To set the remote controller to CD mode, press the [CD] Remote Mode button.

- 1 **On button**
This button is used to set the CD player to On or Standby.
- 2 **Number buttons**
These buttons are used to enter track numbers and to enter times for locating specific points in time.
- 3 **Disc button**
This button is used to select discs on a CD changer.
- 4 **Display button**
This button is used to display information about the current disc or track on the CD player's display, including the elapsed time, remaining time, total time, and so on.
- 5 **Playback buttons**
From left to right: Previous, Play, Next, Fast Reverse, Pause, Stop, and Fast Forward.
- 6 **Repeat button**
This button is used to set the repeat playback functions.
- 7 **Open/Close [▲] button**
This button is used to open and close the disc tray.
- 8 **Clear button**
This button is used to cancel functions and to clear entered numbers.
- 9 **VOL button**
This button is used to adjust the volume of the AV receiver.
- 10 **Muting button**
This button is used to mute the AV receiver.
- 11 **Random button**
This button is used with the random playback function.
- 12 **Memory button**
This button is used with the memory playback function, which allows you to create a custom playlist of tracks.

Remote Controller—Continued

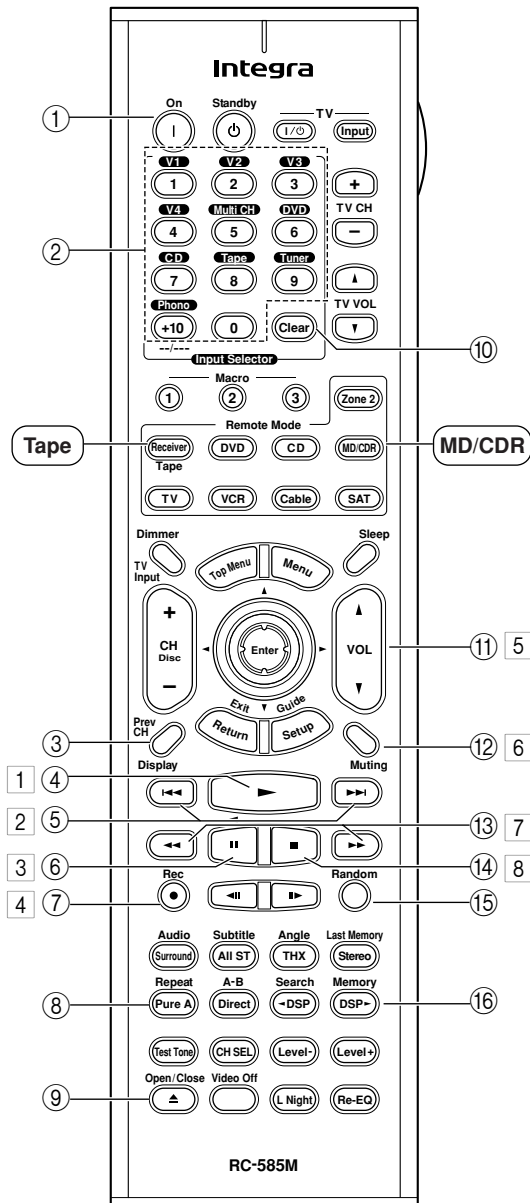

Round numbers are for MD/CDR mode.
Square numbers are for TAPE mode.

MD/CDR Mode

MD/CDR mode is used to control an Integra MiniDisc recorder or CD recorder connected to the AV receiver via **RI**.

To select MD/CDR mode, press the **[MD/CDR] Remote Mode** button.

By default, this button is set to control a MiniDisc recorder. To control a CD recorder, it must be set to CDR (see page 80).

- ① **On button**
This button is used to set the MD recorder or CD recorder to On or Standby.
- ② **Number buttons**
These buttons are used to enter track numbers and to enter times for locating specific points in time.
- ③ **Display button**
This button is used to display information about the current disc or track on the MD recorder or CDR recorder's display, including the elapsed time, remaining time, total time, and so on.
- ④ **Play [▶] button**
This button is used to start playback.
- ⑤ **Previous & Next [◀◀]/[▶▶] buttons**
The Previous [◀◀] button is used to select the previous track. During playback it selects the beginning of the current track. The Next [▶▶] button is used to select the next track.
- ⑥ **Pause [||] button**
This button is used to pause playback.
- ⑦ **Rec [●] button**
This button is used to start recording.
- ⑧ **Repeat button**
This button is used to set the repeat playback functions.
- ⑨ **Open/Close [▲] button**
This button is used to eject a MiniDisc or to open and close the CD recorder's disc tray.
- ⑩ **Clear button**
This button is used to cancel functions and to clear entered numbers.
- ⑪ **VOL button**
This button is used to adjust the volume of the AV receiver.
- ⑫ **Muting button**
This button is used to mute the AV receiver.

Remote Controller—Continued

⑬ FR & FF [◀◀]/[▶▶] buttons

The FR [◀◀] button is used to start fast reverse. The FF [▶▶] button is used to start fast forward.

⑭ Stop [■] button

This button is used to stop playback.

⑮ Random button

This button is used with the random playback function.

⑯ Memory button

This button is used with the memory playback function, which allows you to create a custom playlist of tracks.

TAPE Mode

TAPE mode is used to control an Integra cassette recorder connected to the AV receiver via **RI**.

To set the remote controller to TAPE mode, press the [Tape] Remote Mode button.

For double cassette decks, only Deck B can be controlled.

1 Play [▶] button

This button is used to start playback.

2 Previous & Next [◀◀]/[▶▶] buttons

The Previous [◀◀] button is used to select the previous track. During playback it selects the beginning of the current track. The Next [▶▶] button is used to select the next track.

The Previous and Next [◀◀]/[▶▶] buttons may not work properly with some cassette tapes depending on how they were recorded.

3 Reverse Play [◀] button

This button is used to start reverse playback.

4 Rec [●] button

This button is used to start recording.

5 VOL button

This button is used to adjust the volume of the AV receiver.

6 Muting button

This button is used to mute the AV receiver.

7 Rewind & FF [◀◀]/[▶▶] buttons

The Rewind [◀◀] button is used to start rewind. The FF [▶▶] button is used to start fast forward.

8 Stop [■] button

This button is used to stop playback.

About Home Theater

Enjoying Home Theater

Thanks to the AV receiver's superb capabilities, you can enjoy surround sound with a real sense of movement in your own home—just like being in a movie theater or concert hall. With DVDs you can enjoy DTS and Dolby Digital. With analog and digital TV you can enjoy Dolby Pro Logic IIx or Onkyo's own DSP surround listening modes.

With the DTR-6.5 you can enjoy DVDs that feature THX Surround EX (THX-certified THX speaker system recommended).

Front left and right speakers

These output the overall sound. Their role in a home theater is to provide a solid anchor for the sound image. They should be positioned facing the listener at about ear level, and equidistant from the TV. Angle them inward so as to create a triangle, with the listener at the apex.

Center speaker

This speaker enhances the front left and right speakers, making sound movements distinct and providing a full sound image. In movies it's used mainly for dialog.

Position it close to your TV (preferably on top) facing forward at about ear level, or at the same height as the front left and right speakers.

Subwoofer

The subwoofer handles the bass sounds of the LFE (Low-Frequency Effects) channel. The volume and quality of the bass output from your subwoofer will depend on its position, the shape of your listening room, and your listening position. In general, a good bass sound can be obtained by installing the subwoofer in a front corner, or at one-third the width of the wall, as shown.

Tip: To find the best position for your subwoofer, while playing a movie or some music with good bass, experiment by placing your subwoofer at various positions within the room, and choose the one that provides the most satisfying results.

Surround left and right speakers

These speakers are used for precise sound positioning and to add realistic ambience.

Position them at the sides of the listener, or slightly behind, about 2–3 feet (60–100 cm) above ear level. Ideally they should be equidistant from the listener.

Surround back left and right speakers

These speakers are necessary to enjoy Dolby Digital EX, DTS-ES Matrix, DTS-ES Discrete, and THX Surround EX (DTR-6.5 only). They enhance the realism of surround sound and improve sound localization behind the listener. Position them behind the listener about 2–3 feet (60–100 cm) above ear level.

For the DTR-6.5, THX recommends that they be placed equidistant from the listener, creating a triangle, and that the angle at the apex of the triangle is about 60 degrees. Make sure that the listening position is within the range of the speakers.

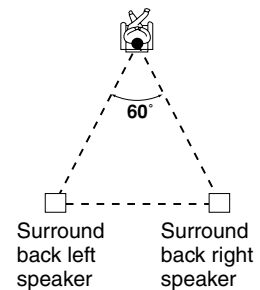
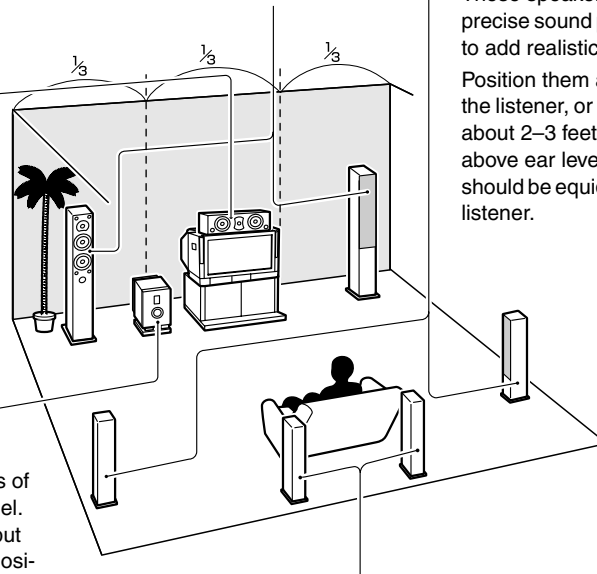

Connecting the AV receiver

About AV Connections

- Before making any AV connections, read the manuals supplied with your other AV components.
- Don't connect the power cord until you've completed and double-checked all AV connections.

Optical Digital Jacks

The AV receiver's optical digital jacks have shutter-type covers that open when an optical plug is inserted and close when it's removed. Push plugs in all the way.

Caution: To prevent shutter damage, hold the optical plug straight when inserting and removing.

AV Connection Color Coding

RCA-type AV connections are usually color coded: red, white, and yellow. Use red plugs to connect right-channel audio inputs and outputs (typically labeled "R"). Use white plugs to connect left-channel audio inputs and outputs (typically labeled "L"). And use yellow plugs to connect composite video inputs and outputs.

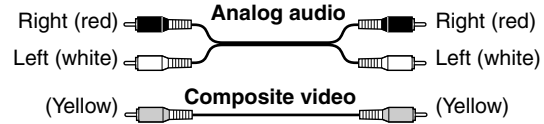

- Push plugs in all the way to make good connections (loose connections can cause noise or malfunctions).
- To prevent interference, keep audio and video cables away from power cords and speaker cables.

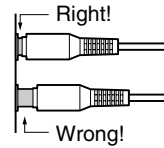

AV Cables & Jacks

Video

Cable	Jack	Description
		Component video separates the luminance (Y) and color difference signals (PR, PB), providing the best picture quality. (Some TV manufacturers label their component video sockets slightly differently.)
		S-Video separates the luminance and color signals and provides better picture quality than composite video.
		Composite video is commonly used on TVs, VCRs, and other video equipment. Use only dedicated composite video cables.

Audio

Cable	Jack	Description
		Offers the best sound quality and allows you to enjoy surround sound (e.g., Dolby Digital, DTS). The audio quality is the same as for coaxial.
		Offers the best sound quality and allows you to enjoy surround sound (e.g., Dolby Digital, DTS). The audio quality is the same as for optical.
		This cable carries analog audio. It's the most common connection format for analog audio, and can be found on virtually all AV components.
		This cable carries multichannel analog audio and it's typically used to connect DVD players with a 5.1-channel analog audio output. Several standard analog audio cables can be used instead of a multi-channel cable.

Connecting the AV receiver—Continued

Connecting Your Speakers

Speaker Configuration

For the best surround-sound experience, you should connect seven speakers and a powered subwoofer.

The following table indicates the channels you should use depending on the number of speakers that you have.

Number of speakers:	2	3	4	5	6	7
Front left	✓	✓	✓	✓	✓	✓
Front right	✓	✓	✓	✓	✓	✓
Center		✓		✓	✓	✓
Surround left			✓	✓	✓	✓
Surround right			✓	✓	✓	✓
Surround back*					✓	
Surround back left						✓
Surround back right						✓

*If you're using only one surround back speaker, connect it to the left (L) SURROUND BACK SPEAKERS terminals.

No matter how many speakers you use, a powered subwoofer is recommended for a really powerful and solid bass.

To get the best from your surround-sound system, you need to set the speaker settings by using the supplied setup microphone (see page 39).

Using Dipole Speakers

You can use dipole speakers for the surround left and right and surround back left and right speakers. Dipole speakers output the same sound in two directions.

Dipole speakers typically have an arrow printed on them to indicate how they should be positioned. The surround left and right dipole speakers should be positioned so that their arrows point toward the TV/screen, while the surround left and right dipole speakers should be positioned so that their arrows point toward each other, as shown.

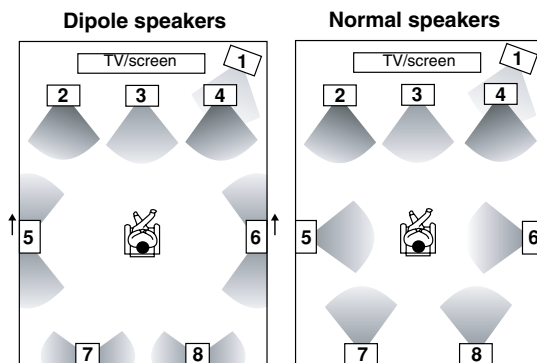

1. Subwoofer
2. Front left speaker
3. Center speaker
4. Front right speaker
5. Surround left speaker

6. Surround right speaker
7. Surround back left speaker
8. Surround back right speaker

Connecting a Powered Subwoofer

Using a suitable cable, connect the AV receiver's SUBWOOFER PRE OUT to an input on your powered subwoofer, as shown. If your subwoofer is unpowered and you're using an external amplifier, connect the SUBWOOFER PRE OUT to an input on the amp.

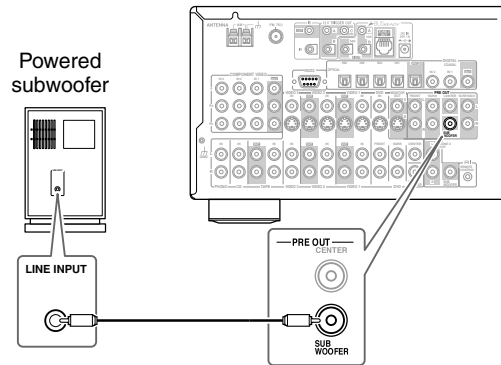

Attaching the Speaker Labels

The AV receiver's positive (+) speaker terminals are color-coded for ease of identification. (The negative (-) speaker terminals are all black.)

Speaker terminal	Color
Front left, Zone 2 left	White
Front right, Zone 2 right	Red
Center	Green
Surround left	Blue
Surround right	Gray
Surround back left	Brown
Surround back right	Tan

The supplied speaker labels are also color-coded and you should attach them to the positive (+) side of each speaker cable in accordance with the above table. All you need to do then is to match the color of each label to the corresponding speaker terminal.



Connecting the AV receiver—Continued



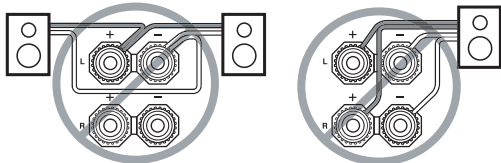
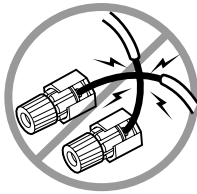

Speaker Connection Precautions

Read the following before connecting your speakers:

- **American model only:** Only connect speakers with an impedance of 6 ohms or higher. If you use speakers with a lower impedance, and use the amplifier at high volume levels for a long period of time, the built-in protection circuit may be activated.
- **Other models:** You can connect speakers with an impedance of between 4 and 16 ohms. If the impedance of any of the connected speakers is 4 ohms or more, but less than 6 ohms, be sure to set the Minimum Speaker Impedance to “4 ohms” (see page 44). If you use speakers with a lower impedance, and use the amplifier at high volume levels for a long period of time, the built-in protection circuit may be activated.
- Disconnect the power cord from the wall outlet before making any connections.
- Read the instructions supplied with your speakers.
- Pay close attention to speaker wiring polarity. In other words, connect positive (+) terminals to only positive (+) terminals, and negative (–) terminals to only negative (–) terminals. If you get them the wrong way around, the sound will be out of phase and will sound unnatural.
- Unnecessarily long, or very thin speaker cables may affect the sound quality and should be avoided.
- Be careful not to short the positive and negative wires. Doing so may damage the AV receiver.
- Don't connect more than one cable to each speaker terminal. Doing so may damage the AV receiver.
- Don't connect one speaker to several terminals.

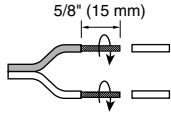

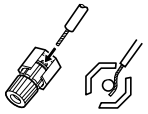
Connecting the Speaker Cables

- 1 **Strip about 5/8" (15 mm) of insulation from the ends of the speaker cables, and twist the bare wires tightly, as shown.** 
- 2 **Unscrew the terminal.** 
- 3 **Fully insert the bare wires.** 
- 4 **Screw the terminal tight.** 

The following illustration shows which speaker should be connected to each pair of terminals.

If you're using only one surround back speaker, connect it to the left (L) SURROUND BACK SPEAKERS terminals.

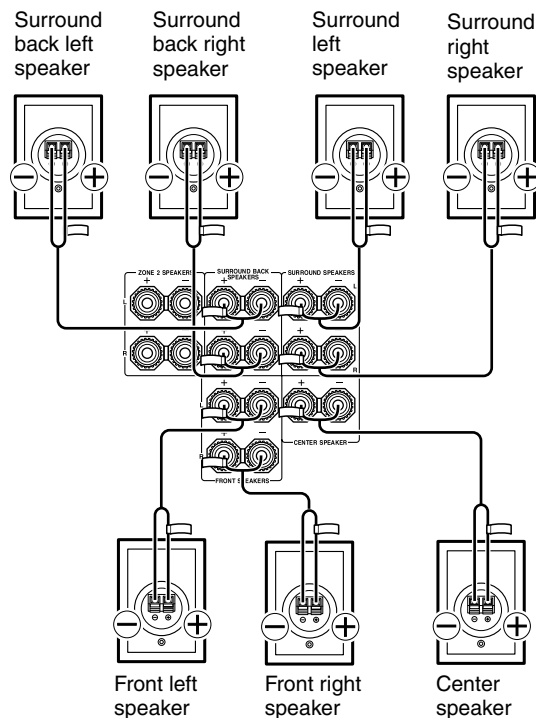

Connecting the AV receiver—Continued

Connecting Antenna

This section explains how to connect the supplied indoor FM antenna and AM loop antenna, and how to connect commercially available outdoor FM and AM antennas. The AV receiver won't pick up any radio signals without any antenna connected, so you must connect the antenna to use the tuner.

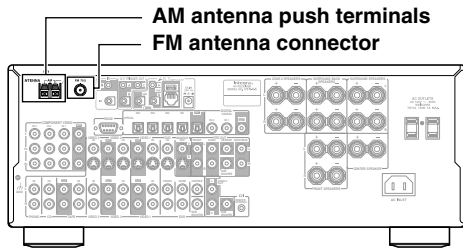

Connecting the Indoor FM Antenna

The supplied indoor FM antenna is for indoor use only.

1 Attach the FM antenna, as shown.

■ American Model

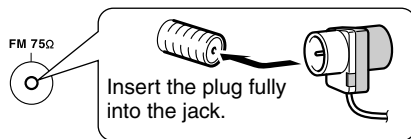

■ Other Models

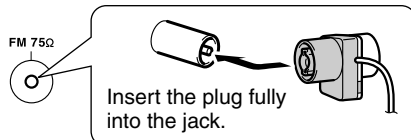

Once your AV receiver is ready for use, you'll need to tune into an FM radio station and adjust the position of the FM antenna to achieve the best possible reception.

2 Use thumbtacks or something similar to fix the FM antenna into position.

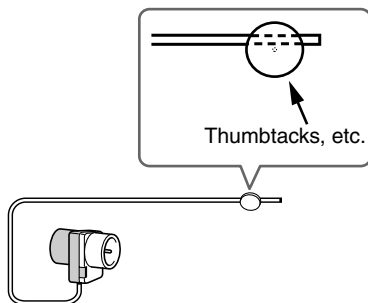

Caution: Be careful that you don't injure yourself when using thumbtacks.

If you cannot achieve good reception with the supplied indoor FM antenna, try a commercially available outdoor FM antenna instead (see page 25).

Connecting the AM Loop Antenna

The supplied indoor AM loop antenna is for indoor use only.

1 Assemble the AM loop antenna, inserting the tabs into the base, as shown.

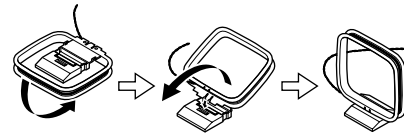

2 Connect both wires of the AM loop antenna to the AM push terminals, as shown.

(The antenna's wires are not polarity sensitive, so they can be connected either way around).

Make sure that the wires are attached securely and that the push terminals are gripping the bare wires, not the insulation.

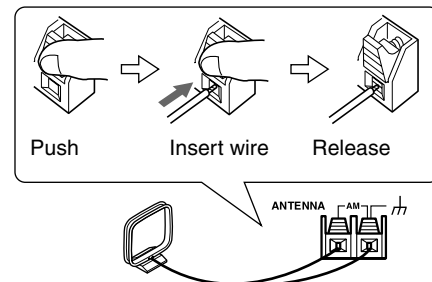

Once your AV receiver is ready for use, you'll need to tune into an AM radio station and adjust the position of the AM antenna to achieve the best possible reception.

Keep the antenna as far away as possible from your AV receiver, TV, speaker cables, and power cords.

If you cannot achieve good reception with the supplied indoor AM loop antenna, try using it with a commercially available outdoor AM antenna (see page 25).

Connecting the AV receiver—Continued

Connecting an Outdoor FM Antenna

If you cannot achieve good reception with the supplied indoor FM antenna, try a commercially available outdoor FM antenna instead.

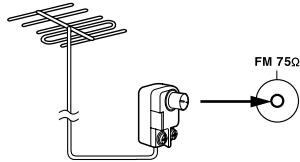

Notes:

- Outdoor FM antennas work best outside, but usable results can sometimes be obtained when installed in an attic or loft.
- For best results, install the outdoor FM antenna well away from tall buildings, preferably with a clear line of sight to your local FM transmitter.
- Outdoor antenna should be located away from possible noise sources, such as neon signs, busy roads, etc.
- For safety reasons, outdoor antenna should be situated well away from power lines and other high-voltage equipment.
- Outdoor antenna must be grounded in accordance with local regulations to prevent electrical shock hazards.

■ Using a TV/FM Antenna Splitter

It's best not to use the same antenna for both FM and TV reception, as this can cause interference problems. If circumstances demand it, use a TV/FM antenna splitter, as shown.

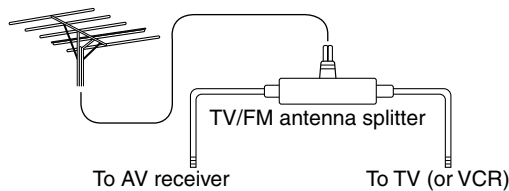

Connecting an Outdoor AM Antenna

If good reception cannot be achieved using the supplied AM loop antenna, an outdoor AM antenna can be used in addition to the loop antenna, as shown.

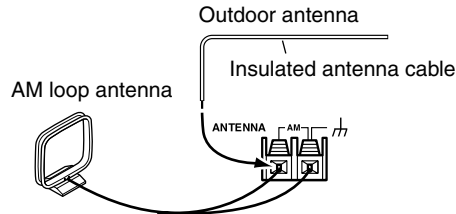

Outdoor AM antennas work best when installed outside horizontally, but good results can sometimes be obtained indoors by mounting horizontally above a window. Note that the AM loop antenna should be left connected.

Outdoor antenna must be grounded in accordance with local regulations to prevent electrical shock hazards.

Connecting the AV receiver—Continued

Connecting Both Audio & Video

By connecting both the audio and video outputs of your DVD player and other AV components to the AV receiver, you can select both the audio and video simultaneously simply by selecting the appropriate input source on the AV receiver.

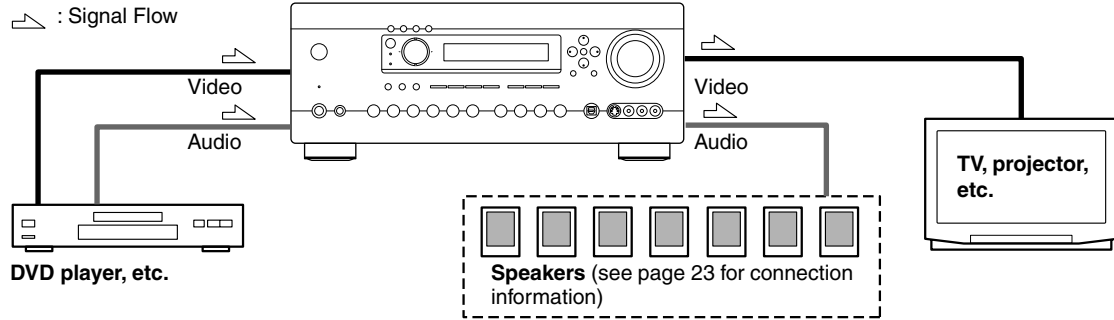

Which Connections Should I Use?

The AV receiver supports several connection formats for compatibility with a wide range of AV equipment. The format you choose will depend on the formats supported by your other components. Use the following sections as a guide. For video components, you must make two connections—one for audio, one for video.

Video Connection Formats

Video equipment can be connected to the AV receiver by using any one of the following video connection formats: composite video, S-Video, or component video, the latter offering the best picture quality.

A video signal connected to a V or S IN jack will be converted—composite video to S-Video or S-Video to composite video—but only for the MONITOR OUT jacks, not the VIDEO 1 and VIDEO 2 OUT V and S jacks.

Note: The DTR-6.5/5.5 can be set to upconvert composite video and S-Video input signals and output them from the COMPONENT VIDEO OUT (see page 43).

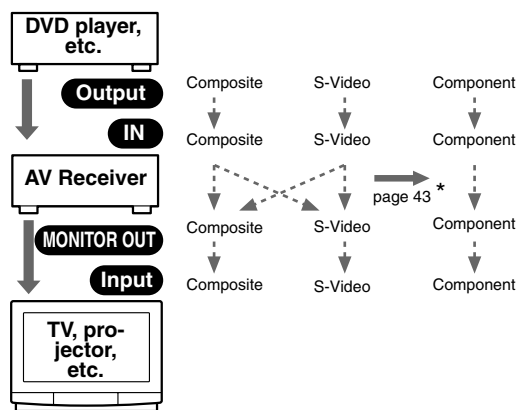

Audio Connection Formats

Audio equipment can be connected to the AV receiver by using any of the following audio connection formats: analog, optical, coaxial, or multichannel.

When choosing a connection format, bear in mind that the AV receiver doesn't convert between them. For example, audio signals connected to an OPTICAL or COAXIAL input are not output by the analog TAPE OUT.

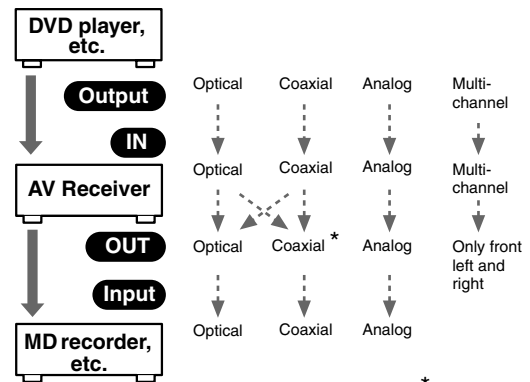

* DTR-6.5 only

Connecting the AV receiver—Continued

Connecting Your TV or Projector

Monitor Out

■ Using Composite Video

Use a composite video cable to connect the AV receiver's V MONITOR OUT jack to a composite video input on your TV, as shown.

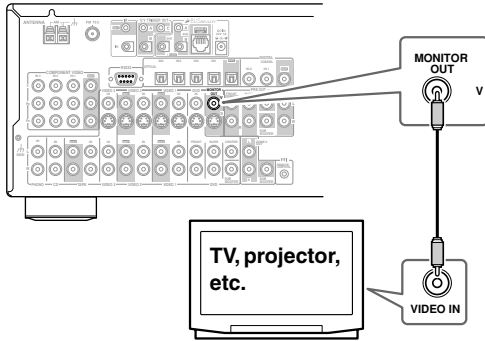

■ Using S-Video

Use an S-Video cable to connect the AV receiver's S MONITOR OUT jack to an S-Video input on your TV, as shown.

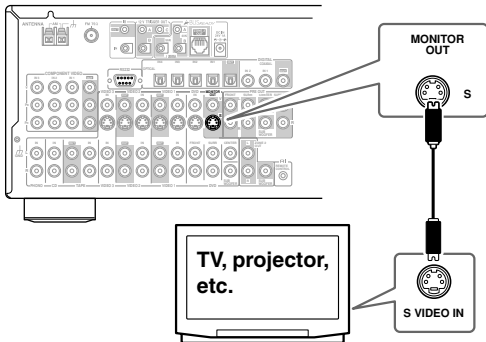

■ Using Component Video

Use a component video cable to connect the AV receiver's COMPONENT VIDEO OUT jacks to a component video input on your TV, as shown.

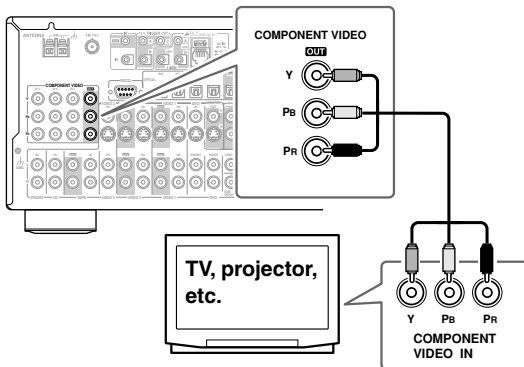

Audio Connections

These connections will allow you to listen to audio from your TV via the AV receiver.

If your TV doesn't have an audio output, connect the AV receiver to your VCR and use its tuner (see page 30).

■ Using Coaxial or Optical Connections

If you connect to a digital audio input, you'll need to assign it (see page 42).

- Use an optical digital audio cable to connect one of the AV receiver's OPTICAL DIGITAL IN jacks to an optical output on your TV, as shown.

OR

- Use a coaxial digital audio cable to connect one of the AV receiver's COAXIAL DIGITAL IN jacks to a coaxial output on your TV, as shown.

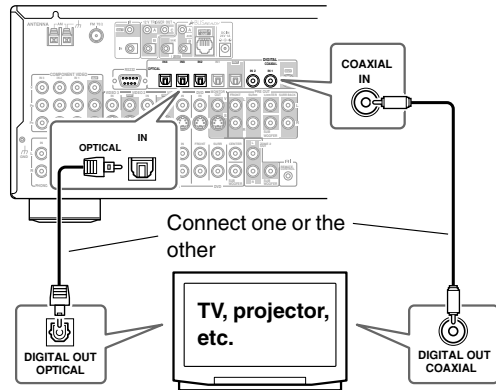

■ Using Analog Connections

If your TV doesn't have a digital audio output, or you want to record from it, you'll need to make the following analog audio connection.

Use an analog audio cable to connect the AV receiver's VIDEO 3 IN L/R jacks to an analog audio output on your TV, as shown.

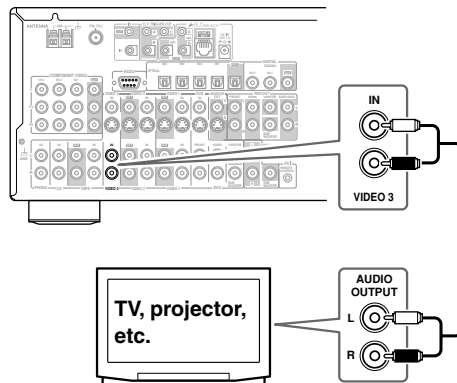

Connecting the AV receiver—Continued

Connecting a DVD Player

Video Connections

You only need to use one of the following connection methods.

■ Using Composite Video

Use a composite video cable to connect the AV receiver's V DVD IN jack to the composite video output on your DVD player, as shown.

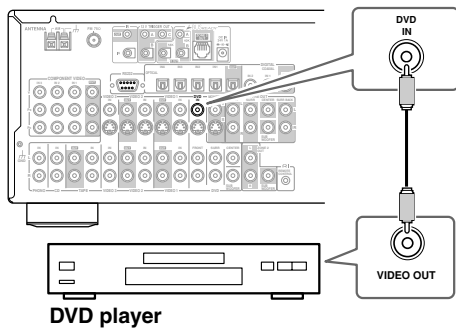

■ Using S-Video

Use an S-Video cable to connect the AV receiver's S DVD IN jack to the S-Video output on your DVD player, as shown.

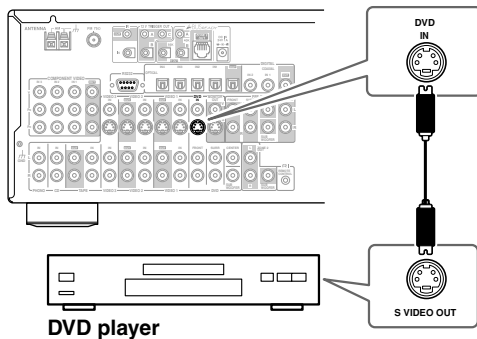

■ Using Component Video

Use a component video cable to connect the AV receiver's COMPONENT VIDEO IN1 jacks to the component video output on your DVD player, as shown.

- Your TV must also be connected via component video.

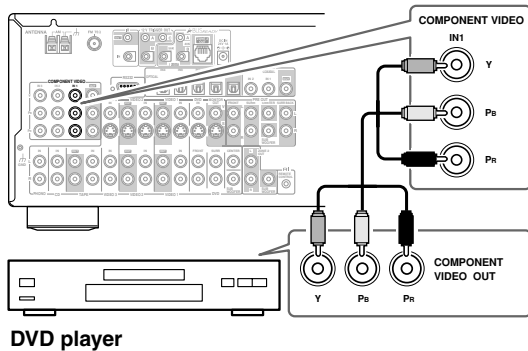

Audio Connections

■ Using Coaxial or Optical Connections

- Use an optical digital audio cable to connect one of the AV receiver's OPTICAL DIGITAL IN jacks to the optical output on your DVD player, as shown.

OR

- Use a coaxial digital audio cable to connect one of the AV receiver's COAXIAL DIGITAL IN jacks to the coaxial output on your DVD player, as shown.

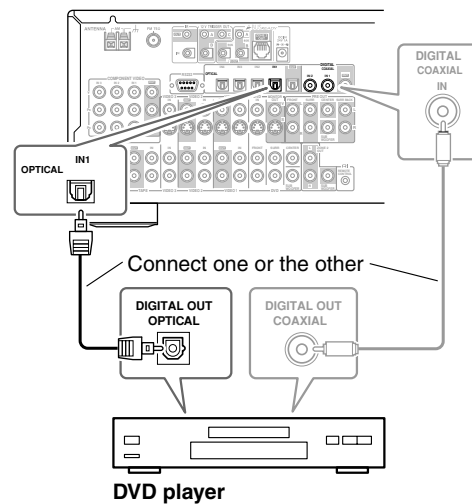

Initially, the OPTICAL IN1 jack is assigned to the DVD input source. If you connect your DVD player to a different digital input, you'll need to reassign the DVD input source (see page 42).

■ Using Analog Connections

Even if your DVD player is connected digitally (optical or coaxial), to use **RI**, or to record audio from your DVD player, you'll need to make an analog connection as well.

Use an analog audio cable to connect the AV receiver's DVD IN L/R jacks to the analog audio output on your DVD player, as shown.

If your DVD player has stereo (L/R) and multichannel outputs, be sure to use the left and right outputs.

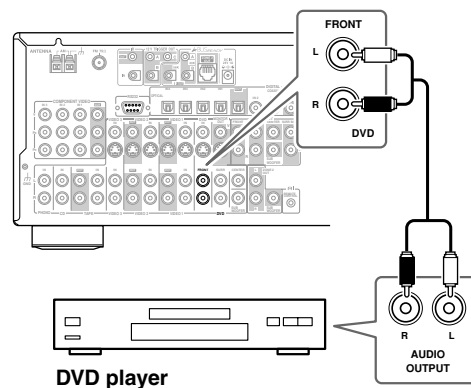

Connecting the AV receiver—*Continued*

■ Using a Multichannel Connection

If your DVD player supports multichannel audio formats such as DVD-Audio, and it has a 5.1-channel analog audio output, you can enjoy DVD-Audio playback.

Use a multichannel analog audio cable to connect the AV receiver's DVD IN FRONT L/R, CENTER, SURR L/R, and SUBWOOFER jacks to the 5.1-channel analog audio output on your DVD player, as shown. Alternatively, use several analog audio cables.

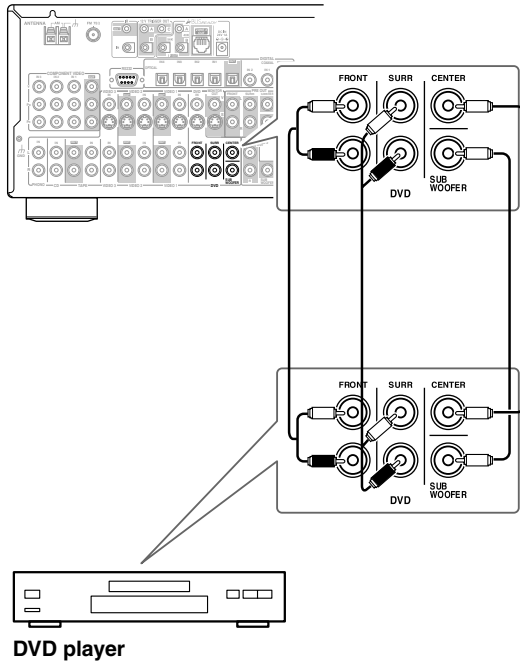

Connecting the AV receiver—Continued

Connecting a VCR for Playback

This section shows how to connect a VCR for playback so that you can watch videos via the AV receiver.

Video Connections

- Use an S-Video cable to connect the AV receiver's S VIDEO 1 IN jack to a S-Video output on your VCR, as shown.

OR

- Use a composite video cable to connect the AV receiver's V VIDEO 1 IN jack to a composite video output on your VCR, as shown.

An S-Video connection provides better picture quality than a composite video connection.

Audio Connections

- Use an analog audio cable to connect the AV receiver's VIDEO 1 IN L/R jacks to an analog audio output on your VCR, as shown.

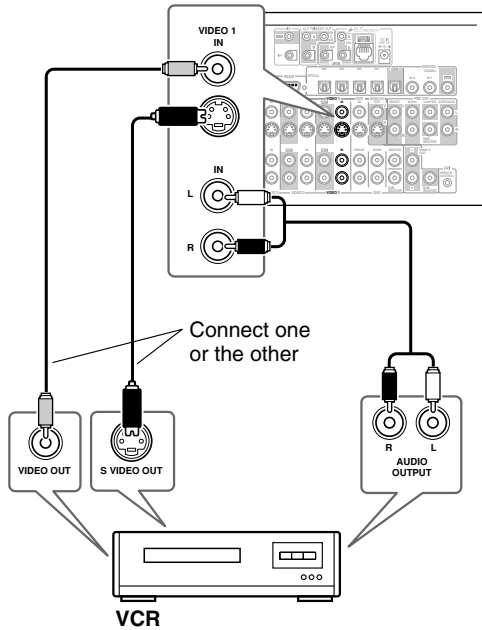

Connecting a D-VHS VCR for Playback

Video Connections

If you connect to a component video input, you must assign it (see page 43).

Use a component video cable to connect the AV receiver's COMPONENT VIDEO IN2 or 3 jacks to a component video output on your D-VHS VCR, as shown.

Your TV must also be connected via component video.

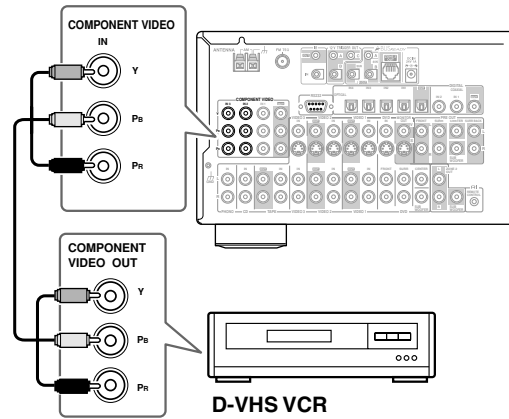

Audio Connections

If you connect to a digital audio input, you'll need to assign it (see page 42).

- Use an optical digital audio cable to connect one of the AV receiver's OPTICAL DIGITAL IN jacks to an optical output on your D-VHS VCR, as shown.

OR

- Use a coaxial digital audio cable to connect one of the AV receiver's COAXIAL DIGITAL IN jacks to a coaxial output on your D-VHS VCR, as shown.

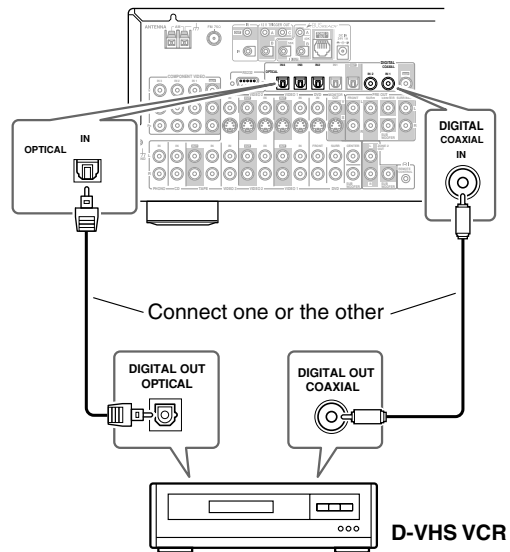

Connecting the AV receiver—Continued

Connecting a VCR for Recording

This section explains how to connect a VCR for recording from a TV or another VCR.

Video Connections

- Use an S-Video cable to connect the AV receiver's S VIDEO 1 OUT jack to an S-Video input on the recording VCR. Use another S-Video cable to connect the AV receiver's S VIDEO 3 IN jack to an S-Video output on your TV or playback VCR, as shown.

OR

- Use a composite video cable to connect the AV receiver's V VIDEO 1 OUT jack to a composite video input on the recording VCR. Use another composite video cable to connect the AV receiver's V VIDEO 3 IN jack to a composite video output on your TV or playback VCR, as shown.

Audio Connections

- Use an analog audio cable to connect the AV receiver's VIDEO 1 OUT L/R jacks to an audio input on the recording VCR.
- Use an analog audio cable to connect the AV receiver's VIDEO 3 IN L/R jacks to an audio output on your TV or playback VCR.

Playback from the Recording VCR

To play back a video in the recording VCR via the AV receiver:

- Use an S-Video cable to connect the AV receiver's S VIDEO 1 IN jack to an S-Video output on the recording VCR.

OR

- Use a composite video cable to connect the AV receiver's V VIDEO 1 IN jack to a composite video output on the recording VCR. And use an analog audio cable to connect the AV receiver's VIDEO 1 IN L/R jacks to an audio output on the recording VCR.

Notes:

- The AV receiver must be turned on for recording. Recording is not possible while it's in Standby mode.
- If you want to record directly from your TV or playback VCR to the recording VCR without going through the AV receiver, connect the TV/VCR's audio and video outputs directly to the recording VCR's audio and video inputs. See the manuals supplied with your TV and VCR for details.
- Video signals connected to composite video inputs can only be recorded via composite video outputs. If your TV/VCR is connected to a composite video input, the recording VCR must be connected to a composite video output. Similarly, video signals connected to S-Video inputs can only be recorded via S-Video outputs. If your TV/VCR is connected to an S-Video input, the recording VCR must be connected to an S-Video output.

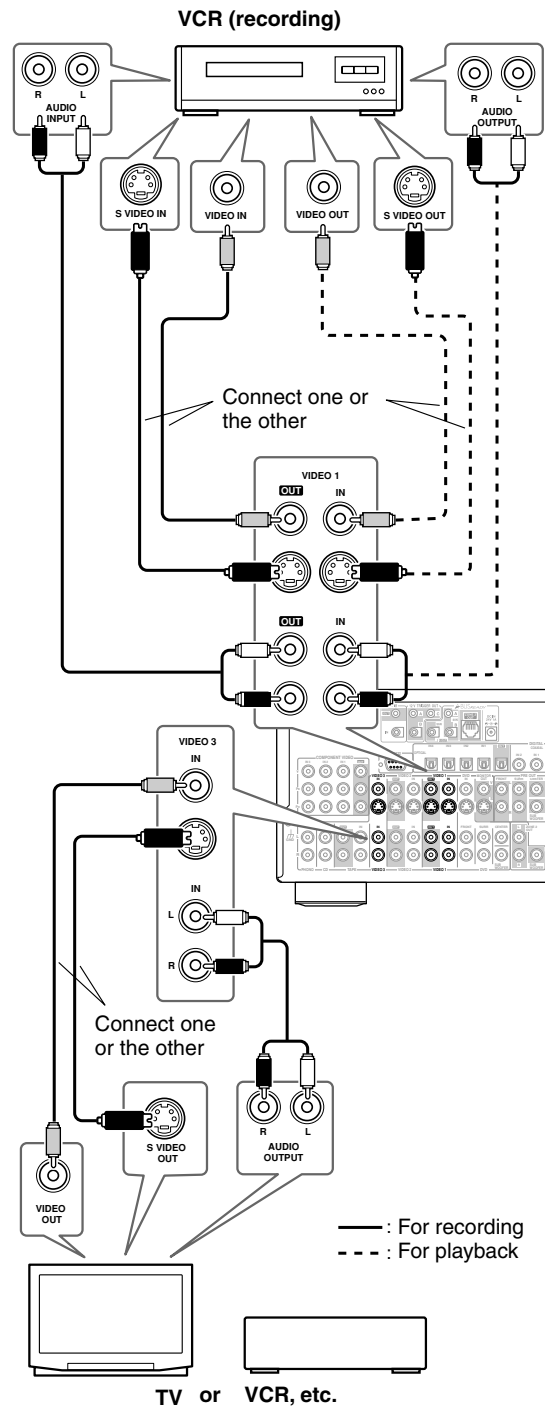

Connecting the AV receiver—Continued

Connecting Other Video Sources— Satellite, Cable, Set-top box, LD Player, etc.

Video Connections

You only need to use one of the following connection methods.

■ Using Composite Video

Use a composite video cable to connect the AV receiver's V VIDEO 3 IN jack to a composite video output on your video source, as shown.

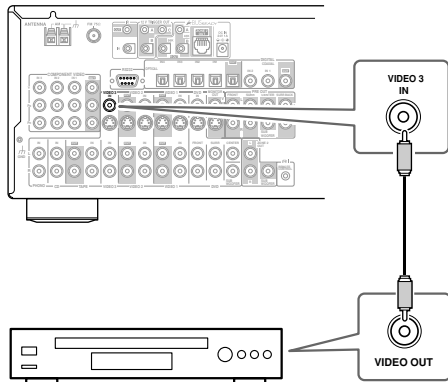

Satellite, cable, set-top box, LD player, etc.

■ Using S-Video

Use an S-Video cable to connect the AV receiver's S VIDEO 3 IN jack to an S-Video output on your video source, as shown.

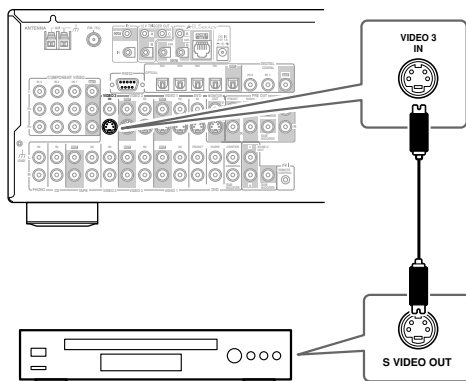

Satellite, cable, set-top box, LD player, etc.

■ Using Component Video

If you connect to a component video input, you must assign it (see page 43).

Use a component video cable to connect the AV receiver's COMPONENT VIDEO IN 2 or IN 3 jack to a component video output on your video source, as shown.

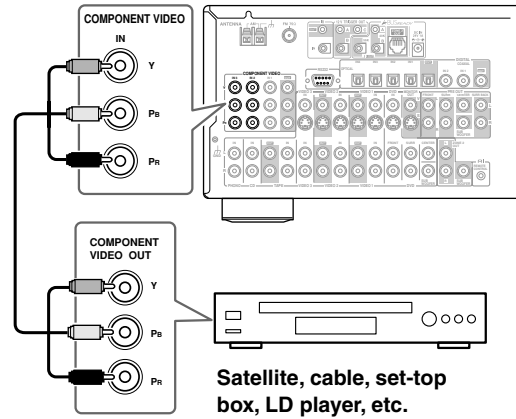

Satellite, cable, set-top box, LD player, etc.

Audio Connections

■ Using Optical or Coaxial Connections

If you connect to a digital audio input, you'll need to assign it (see page 42).

- Use an optical digital audio cable to connect one of the AV receiver's OPTICAL DIGITAL IN jacks to an optical output on your video source, as shown.

OR

- Use a coaxial digital audio cable to connect one of the AV receiver's COAXIAL DIGITAL IN jacks to a coaxial output on your video source, as shown.

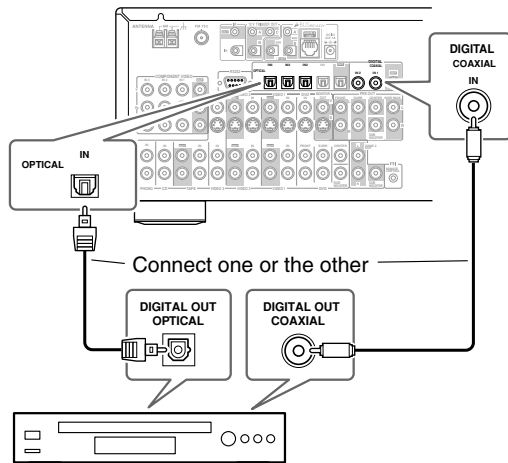

Satellite, cable, set-top box, LD player, etc.

Notes:

- To connect the AV receiver to an LD player's AC-3RF output, you need a commercially available demodulator.

Connecting the AV receiver—Continued

■ Using Analog Connections

If your video source doesn't have a digital audio output, or you want to record from it, you'll need to make the following analog audio connection.

Use an analog audio cable to connect the AV receiver's VIDEO 3 IN L/R jacks to the analog audio output on your video source, as shown.

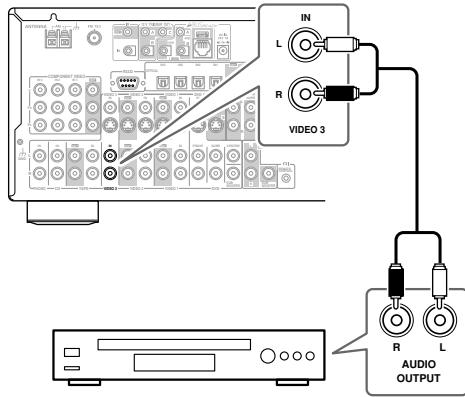

Satellite, cable, set-top box, LD player, etc.

■ Using S-Video

Use an S-Video cable to connect the AV receiver's VIDEO 4 INPUT S VIDEO jack to the S-Video output on your camcorder, games console, etc., as shown.

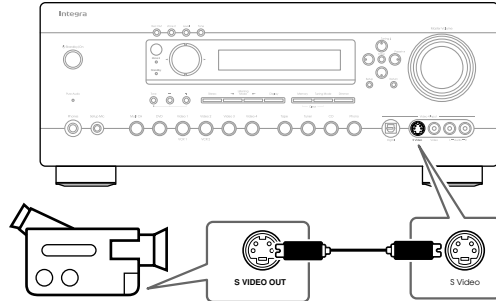

Camcorder, games console, etc.

Audio Connections

Use an analog audio cable to connect the AV receiver's VIDEO 4 INPUT AUDIO L/R jacks to the analog audio output on your camcorder, games console, etc., as shown.

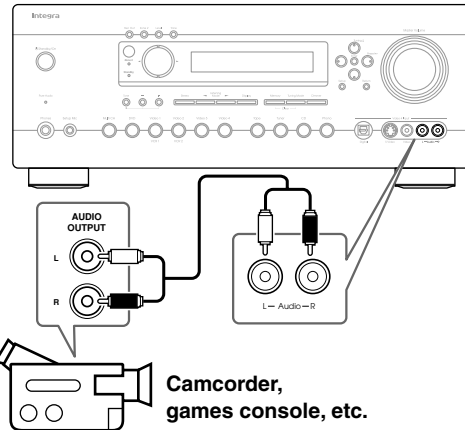

Camcorder, games console, etc.

Connecting a Camcorder, Games Console, etc.

Video Connections

You only need to use one of the following connection methods.

■ Using Composite Video

Use a composite video cable to connect the AV receiver's VIDEO 4 INPUT VIDEO jack to the composite video output on your camcorder, games console, etc., as shown.

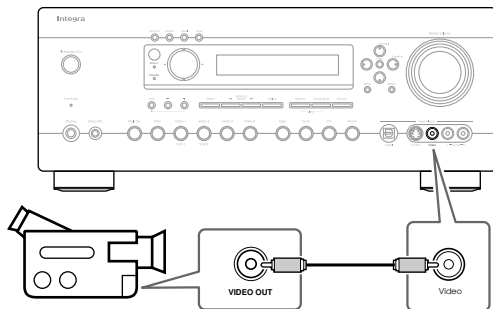

Camcorder, games console, etc.

If your camcorder, games console, etc., has an optical digital audio output, use an optical digital audio cable to connect it to the AV receiver's VIDEO 4 INPUT DIGITAL jack, as shown.

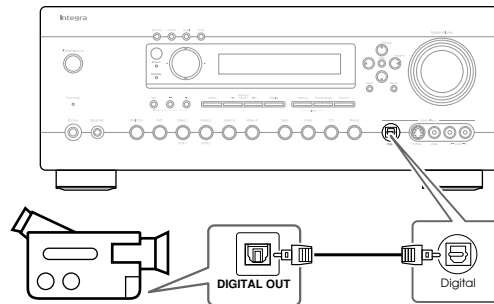

Camcorder, games console, etc.

Connecting the AV receiver—Continued

Connecting a CD Player

■ Using Optical or Coaxial Connections

If you connect to a digital audio input, you'll need to assign it (see page 42).

- Use an optical digital audio cable to connect one of the AV receiver's OPTICAL DIGITAL IN jacks to the optical output on your CD player, as shown.

OR

- Use a coaxial digital audio cable to connect one of the AV receiver's COAXIAL DIGITAL IN jacks to the coaxial output on your CD player, as shown.

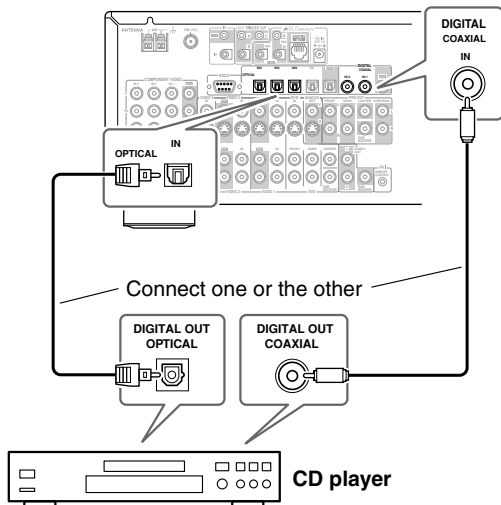

■ Using Analog Connections

Even if your CD player is connected digitally (coaxial or optical), to use **RI**, or to record audio from your CD player, you'll need to make an analog audio connection as well.

Use an analog audio cable to connect the AV receiver's CD IN L/R jacks to the analog audio output on your CD player, as shown.

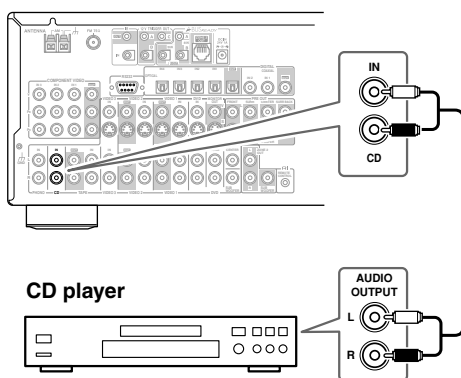

Connecting a Cassette Recorder

Use an analog audio cable to connect the AV receiver's TAPE IN L/R jacks to the cassette recorder's output, and use another analog audio cable to connect the AV receiver's TAPE OUT L/R jacks to the cassette recorder's input, as shown.

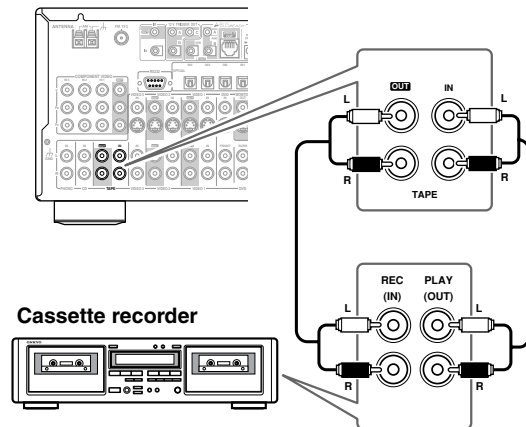

Connecting a DAT, CD, or MD Recorder

You can connect a DAT, CD, or MD recorder instead of a cassette recorder.

■ Analog Connections

Use an analog audio cable to connect the AV receiver's TAPE IN L/R jacks to the recorder's output, and use another analog audio cable to connect the AV receiver's TAPE OUT L/R jacks to the recorder's input, as shown.

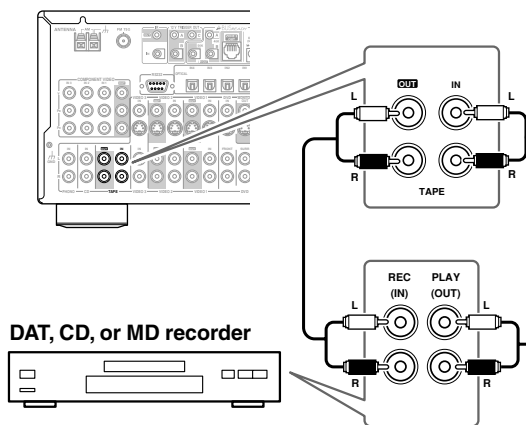

Connecting the AV receiver—Continued

■ Using Optical or Coaxial Connections (playback only)

If you connect to a digital audio input, you'll need to assign it (see page 42).

- Use an optical digital audio cable to connect one of the AV receiver's OPTICAL DIGITAL IN jacks to the optical output on your recorder, as shown.

OR

- Use a coaxial digital audio cable to connect one of the AV receiver's COAXIAL DIGITAL IN jacks to the coaxial output on your recorder, as shown.

Note:

Don't connect the recorder's digital output to the AV receiver when the recorder's digital input is connected to one of the AV receiver's digital outputs. Doing so may create a signal loop and cause a malfunction.

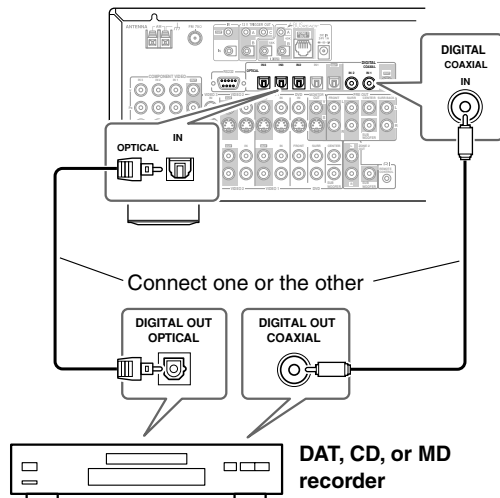

■ Digital Recording

If your recorder has a digital input, by connecting it to the AV receiver's optical DIGITAL OUT jack, you can record digitally. (With the DTR-6.5, you can use its coaxial DIGITAL OUT jack.) However, because the AV receiver doesn't convert analog input signals to digital and vice versa, only input signals connected to a DIGITAL IN jack can be recorded in this way.

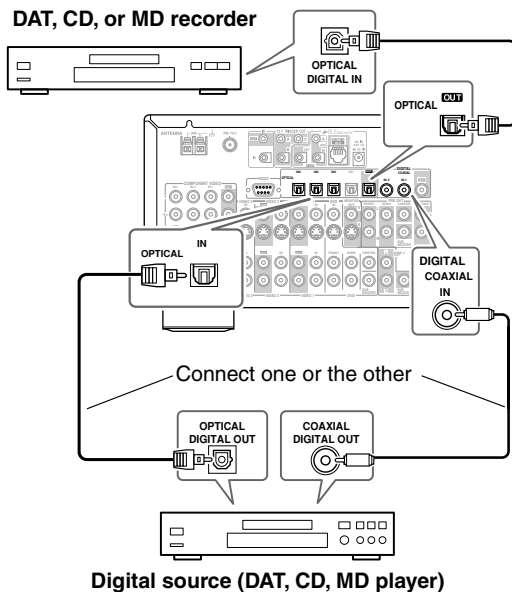

Connecting the AV receiver—Continued

Connecting a Turntable

For the DTR-6.5

The AV receiver's PHONO IN is designed for use with a moving magnet (MM) type cartridge.

Use an analog audio cable to connect the AV receiver's PHONO IN L/R jacks to the audio output on your turntable, as shown.

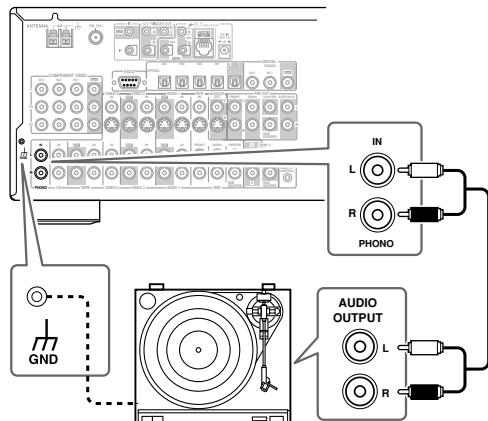

Notes:

- If your turntable has a ground wire, connect it to the AV receiver's GND screw. With some turntables, connecting the ground wire may produce an audible hum. If this happens, disconnect it.
- If your turntable has a moving coil (MC) type cartridge, you'll need a commercially available MC head amp or MC transformer. Connect your turntable to the head amp or transformer, and then connect that to the AV receiver's PHONO IN L/R jacks.
- You can also use a phono equalizer to connect a turntable with an MC-type cartridge. In this case, see the phono equalizer's manual for details.

For the DTR-5.5

■ Turntable with a Built-in Phono Preamp

Use an analog audio cable to connect an unused audio input on the AV receiver to the audio outputs on your turntable, as shown.

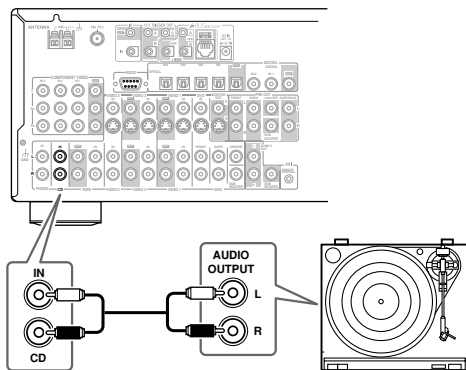

■ Turntable without a Built-in Phono Preamp

Use an analog audio cable to connect an unused audio input on the AV receiver to the audio outputs on your phono preamp, and use another analog audio cable to connect the phono preamp's inputs to your turntable, as shown.

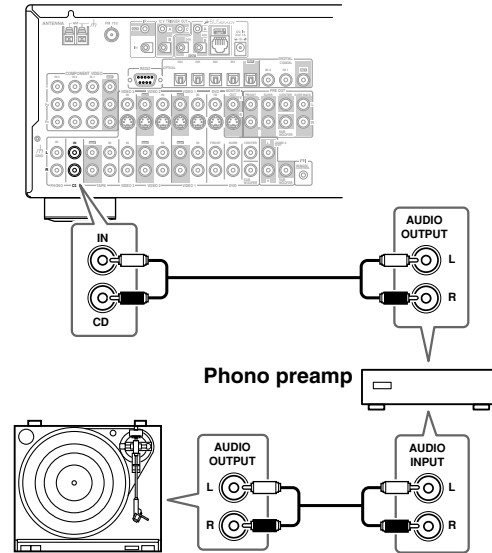

■ Turntable with an MC (Moving Coil) Cartridge

Use an analog audio cable to connect an unused audio input on the AV receiver to the audio outputs on your phono preamp. Use another analog audio cable to connect the phono preamp's inputs to your MC head amp's outputs. And use another analog audio cable to connect the MC head amp's inputs to your turntable, as shown.

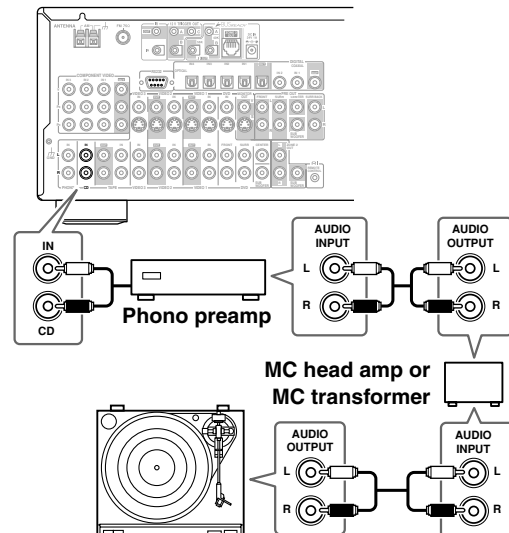

Connecting the AV receiver—Continued

Connecting a Power Amplifier (DTR-6.5 only)

If you want to connect a more powerful power amplifier and use the AV receiver as a preamp, you can connect one to the PRE OUT jacks. In this case, you should connect all speakers and the subwoofer to that power amplifier. However, if you have a powered subwoofer, connect it to this AV receiver's PRE OUT SUBWOOFER jack.

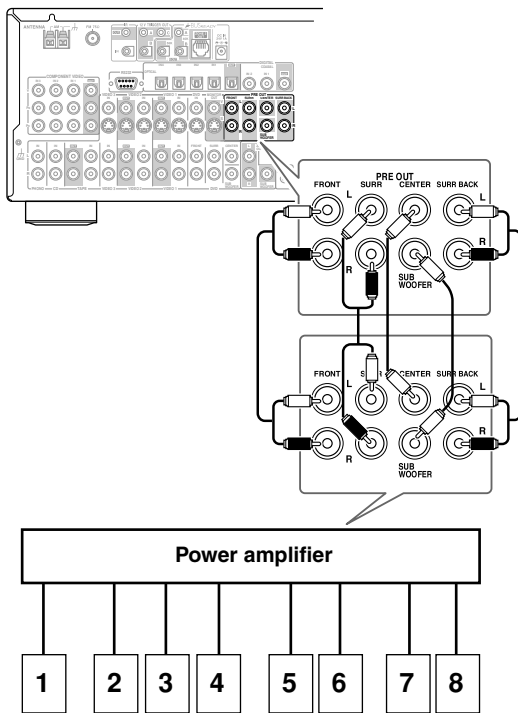

- | | |
|--------------------------|--------------------------------|
| 1. Subwoofer | 6. Surround right speaker |
| 2. Front left speaker | 7. Surround back left speaker |
| 3. Center speaker | 8. Surround back right speaker |
| 4. Front right speaker | |
| 5. Surround left speaker | |

Connecting RI Components

With **RI** (Remote Interactive) you can control your **RI**-compatible Integra CD player, DVD player, and so on with the AV receiver's remote controller, as follows:

- **To use RI, you must make an analog audio connection between the AV receiver and the other AV components, even if they are connected digitally.**

Auto Power On/Standby

When you start playback on an AV component connected via **RI**, if the AV receiver is in Standby, it will turn on and select that AV component as the input source automatically. Similarly, when the AV receiver is set to Standby, all components connected via **RI** also enter Standby. Note that this function will not work if the component's power cord is connected to one of the AV receiver's AC OUTLETS.

Direct Change

When playback is started on an AV component connected via **RI**, the AV receiver automatically selects that AV component as the input source.

Remote Control

You can control your **RI**-compatible Integra components with the AV receiver's remote controller.

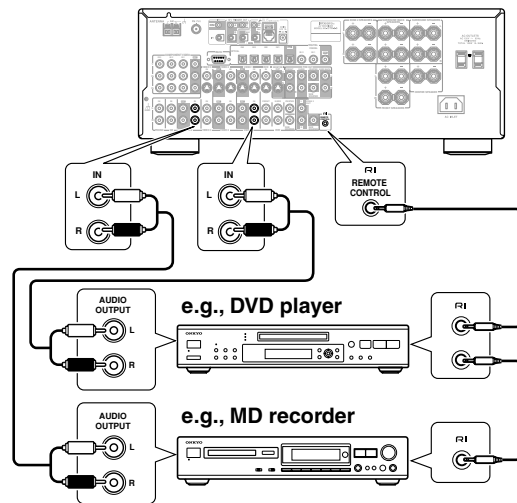

Notes:

- Push plugs in all the way to make good connections.
- Use only **RI** cables for **RI** connections. No **RI** cables are supplied with this AV receiver.
- Some AV components have two **RI** jacks. You can connect either one to this AV receiver. The other jack is for connecting more **RI**-compatible components.
- Connect the AV receiver's **RI** jack to only Integra AV components. Connecting to other manufacturer's AV components may cause them to malfunction.
- Some components may not support all **RI** functions. Refer to the manuals supplied with your components.

Connecting the AV receiver—Continued

Connecting the Power Cords of Other Components

The AV receiver has AC outlets on its rear panel that can be used to connect the power cords of AV other components that you intend to use with the AV receiver. These components can then be left turned on so that they turn on and off as and when the AV receiver is turned on and set to Standby.

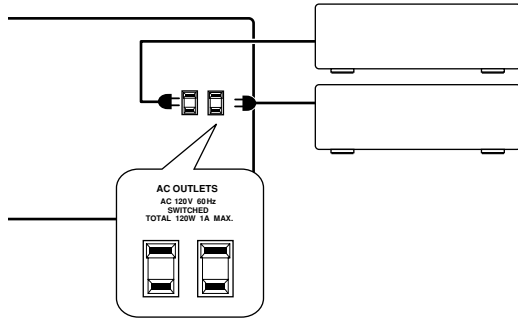

Caution:

- Make sure that the total capacity of the components that you connect to the AC OUTLETS does not exceed the stated capacity (e.g., TOTAL 120 W).

Note:

- Integra components with **RI** jacks should be connected directly to wall outlets, not the AV receiver's AC OUTLETS.
- The number of AC OUTLETS, socket type, and total capacity depends on the country in which you purchased the AV receiver.

Connecting the RS232 Port

This port can be used to connect an external controller for controlling the AV receiver.

Connecting the Supplied Power Cord

Plug the supplied power cord into this AC INLET.

- Do not use a power cord other than the one supplied with this AV receiver. It's designed exclusively for use with this AV receiver and should not be used with any other component.
- Never disconnect the power cord from the AV receiver while the other end is still plugged into a wall outlet. Doing so may cause an electric shock. Always disconnect the power cord from the wall outlet first.

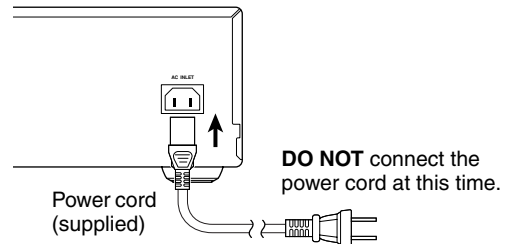

Turning On the AV receiver

Standby/On

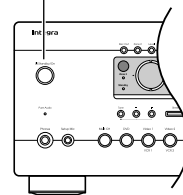

On

Standby

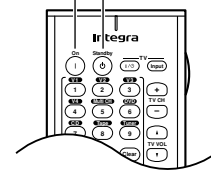

Standby/On



Remote controller



Standby



Press the [Standby/On] button. Alternatively, press the remote controller's [Receiver] button followed by the [On] button.

The AV receiver comes on, the display lights up, and the Standby indicator goes off.

To turn off the AV receiver, press the [Standby/On] button. The AV receiver will enter Standby mode.

Notes:

- Pressing the remote controller's [On] button once will turn on the AV receiver. Pressing it again will turn on any components connected via **RI**.
- When the AV receiver is on Standby, it will turn on automatically when any one of its input selector buttons is pressed.

First Time Setup

This chapter explains the settings that you need to make before using the AV receiver.

Automatic Speaker Setup

With the supplied speaker setup microphone, the Automatic Speaker Setup function can measure the test tone output by each speaker and automatically determine the number of speakers connected, their sizes, the distance from each speaker to the listening position, and so on. Before using this function, connect and position all your speakers.

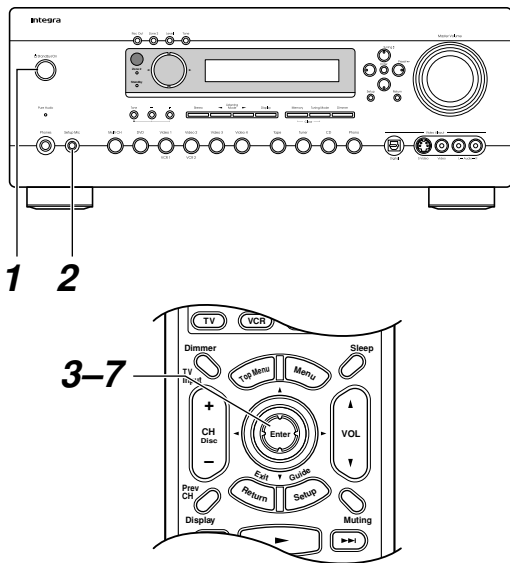

1 Turn on the AV receiver and the connected TV.
On the TV, select the input to which the AV receiver is connected.

2

Put the speaker setup microphone in the listening position, and connect it to the Setup Mic jack.

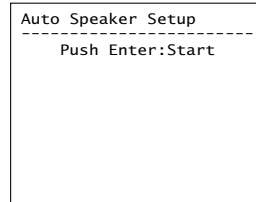
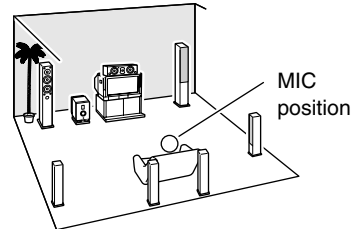

- Notes:**
- Wait at least five seconds after turning on the AV receiver before plugging in the speaker setup microphone.
 - Make sure the microphone is horizontal.
 - If there's an obstacle between the microphone and any speaker, the automatic setup will not work correctly. Set the room how you would have it when enjoying a DVD.
 - If the AV receiver was previously muted, the Muting function will be cancelled.
 - The automatic setup cannot be used while a pair of headphones is connected.
 - By putting the microphone close to where your ears would normally be at the listening position, a more accurate setup can be achieved. If you use a tripod or level table, you can adjust the height of the microphone.

First Time Setup—Continued

3 **Press [Enter].**



```
Auto Speaker Setup
-----
Do not Unplug Setup Mic
Wait a moment, Please.
```

The automatic speaker setup starts. The test tone, which is somewhat loud, is output by each speaker in turn, measured by the microphone, and the speaker settings set accordingly. The whole process takes about 90 seconds.

```
Auto Speaker Setup
-----
Do not Unplug Setup Mic

->Left
Center
Right
Surr Right
SurrBack R
SurrBack L
Surr Left
Subwoofer
```

If any extraneous noise is picked up by the microphone, the automatic setup will not work correctly, so be careful.

4 **When the Check Result menu appears, press [Enter].**



```
Auto Speaker Setup
-----
Push Enter:Check Results
<:Retry >:Set
```

The Setup Result menu appears.

```
0.Auto Sp Setup Result
-----
1.Warning
2.Speaker Config
3.Distance
4.Level
```

- 1 Warning
- 2 Number of speakers and their sizes
- 3 Distance from each speaker to the listening position
- 4 The optimum volume level for each speaker

5 **Use the Up and Down [▲]/[▼] buttons to select the item that you want to check, and then press [Enter].**

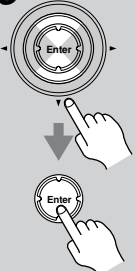

Press the [Return] button to return to the previous menu.

```
0-1.Warning *
-----
Not Connect
-:-:-:-:-:-:-:-:-:-:-
Too Near/Far Speaker
-:-:-:-:-:-:-:-:-:-:-
```

```
0-2.Speaker Config
-----
Subwoofer :Yes
Front :Large
Center :Small
Surround :Small
SurroundBack :Small
SurrBack ch :2ch
Crossover :100Hz
```

```
0-3.Distance
-----
Left : 3.6m
Center : 3.6m
Right : 3.6m
Surr Right : 2.1m
Surr Back R : 2.1m
Surr Back L : 2.1m
Surr Left : 2.1m
Subwoofer : 3.6m
```

```
0-4.Level
-----
Left : 0dB
Center : 0dB
Right : 0dB
Surr Right : 0dB
Surr Back R : 0dB
Surr Back L : 0dB
Surr Left : 0dB
Subwoofer : 0dB
```

(Menus vary depending on country.)

* When a speaker has a warning, its abbreviation (e.g., L, R, and so on) appears instead of the “-:-” dashes.

If you want to adjust any of the settings manually, see “Speaker Setup” on page 46.

6 **When you’ve checked the settings, press the [Return] button to return to the previous menu.**



```
Auto Speaker Setup
-----
Push Enter:Check Results
<:Retry >:Set
```

7 **When you’ve finished the automatic setup, press the Right [▶] button.**



That completes the setup.

To run the automatic setup again, press the Left [◀] button.

The automatic speaker setup starts again.

8 **Disconnect the speaker setup microphone.**

To cancel the automatic setup while it’s in progress, disconnect the microphone.

First Time Setup—Continued

About the Onscreen Setup Menus

The AV receiver is configured using onscreen setup menus, which are displayed on the TV that's connected to either of the MONITOR OUT jacks. Because they appear on your TV, they're large and clear, making setup a breeze.

Settings are divided into two groups: *Basic Setup* and *Advanced Setup*.

When you've configured the settings on the Basic Setup menu correctly, you'll be ready to enjoy movies and music. The Advanced Setup menu contains more detailed settings for an even better sound and increased enjoyment.

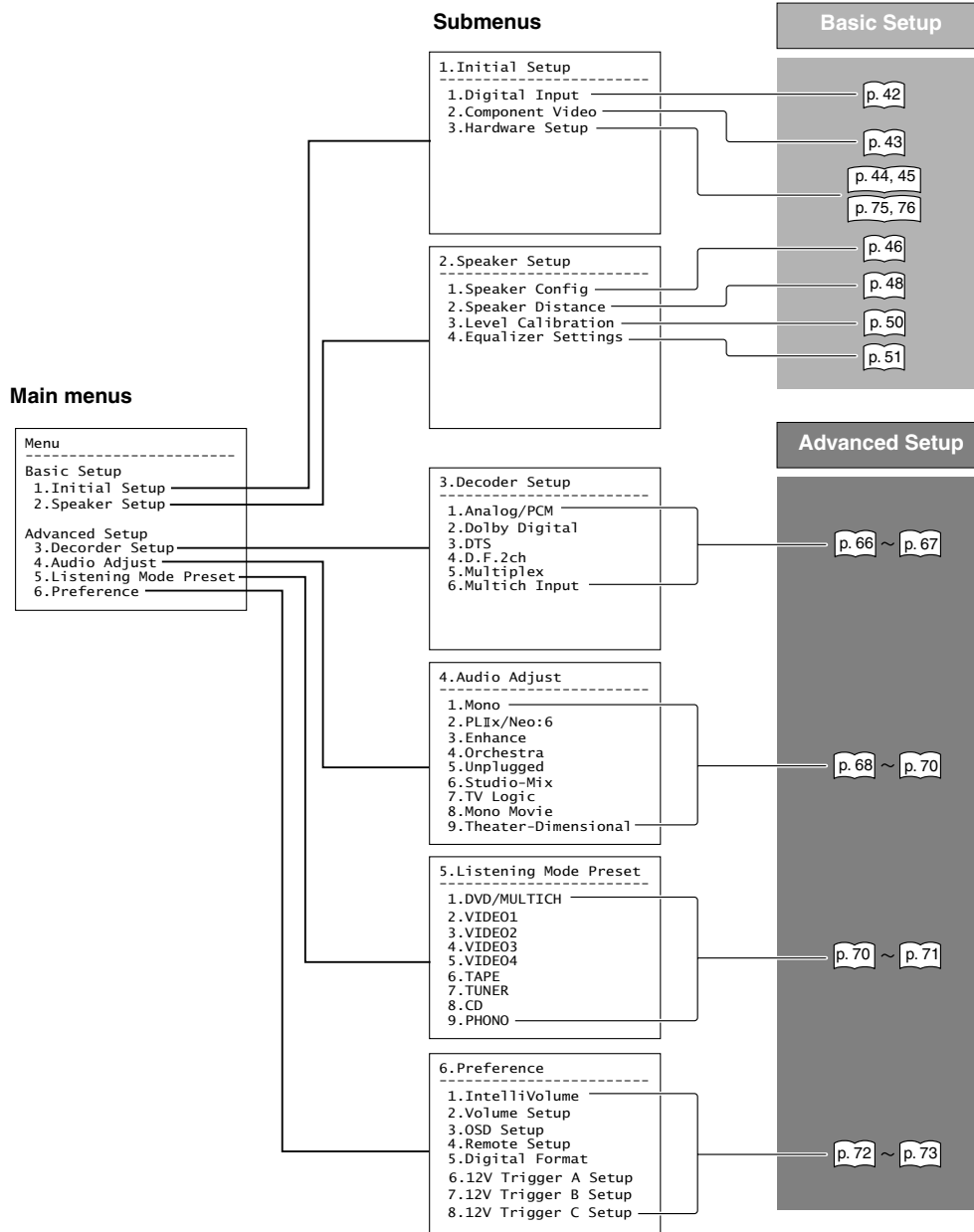

First Time Setup—Continued

Initial Setup

Digital Input

If you connect a component to a digital input jack, you must assign that jack to an input selector. For example, if you connect your CD player to the OPTICAL IN2 jack, you should assign that jack to the CD input selector. By default, the OPTICAL IN1 jack is assigned to the DVD input selector, although this can be changed.

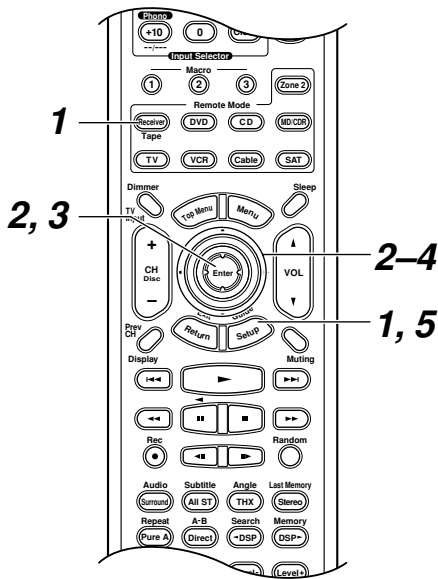

1

Press the [Receiver] button followed by the [Setup] button.
The main menu appears onscreen.

2

Use the Up and Down [▲]/[▼] buttons to select "1. Initial Setup," and then press [Enter].
The Initial Setup menu appears.

3

Use the Up and Down [▲]/[▼] buttons to select "1. Digital Input," and then press [Enter].
The Digital Input menu appears.

Menu	
1. Initial Setup	
1-1. Digital Input	
a. DVD	: OPT1 00
b. VIDEO1	: ---- 00
c. VIDEO2	: ---- 00
d. VIDEO3	: ---- 00
e. TAPE	: ---- 00
f. CD	: ---- 00
g. PHONO	: ---- 00

- There are no assignments for TUNER.
- VIDEO 4 is assigned to the optical digital input on the front panel and cannot be changed.

4

Use the Up and Down [▲]/[▼] buttons to select an input selector, and then use the Left and Right [◀]/[▶] buttons to select a digital input jack.

Examples:

If you connect your DVD player to the OPTICAL IN 2 jack, set "a. DVD" to "OPT2."

If you want to listen to audio from the component connected to the OPTICAL IN 3 jack when the VIDEO 1 input selector is selected, set "b. VIDEO1" to "OPT3."

If you want to listen to audio from the component connected to the COAXIAL IN 1 jack when the VIDEO 2 input selector is selected, set "c. VIDEO2" to "COAX1."

For input selectors that you don't want to assign a digital input jack, leave them set to "----."

5

Press the [Setup] button.
The setup menu closes.

Note:

- This procedure can also be performed on the AV receiver by using its [Setup] button, arrow buttons, and [Enter] button.

First Time Setup—Continued

Component Video Setup

If you connect to a COMPONENT VIDEO IN, you must assign it to an input selector. For example, if you connect your DVD player to COMPONENT IN 3, you should assign it to the DVD input selector.

If you want to output composite and S-Video sources from the COMPONENT VIDEO OUT, select Video, as explained below.

Input selector	Analog audio input (fixed)	COMPONENT VIDEO IN jack
DVD	DVD	IN 1
VIDEO 1	VIDEO 1	Video
VIDEO 2	VIDEO 2	Video
VIDEO 3	VIDEO 3	Video
VIDEO 4	VIDEO 4	Video

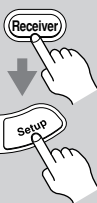
1  Press the [Receiver] button followed by the [Setup] button. The main menu appears onscreen.

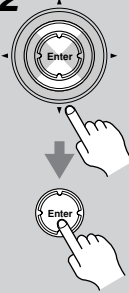
2  Use the Up and Down [▲]/[▼] buttons to select "1. Initial Setup," and then press [Enter]. The initial Setup menu appears.

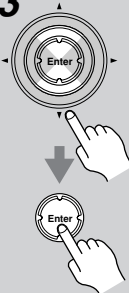
3  Use the Up and Down [▲]/[▼] buttons to select "2. Component Video," and then press the [Enter] button. The Component Video Setup menu appears.

```

Menu
-----
1. Initial Setup
-----
1-2. Component Video
-----
a. DVD/MULTICH : IN1  [00]
b. VIDEO01     : Video [00]
c. VIDEO02     : Video [00]
d. VIDEO03     : Video [00]
e. VIDEO04     : Video [00]
                    
```

4  Use the Up and Down [▲]/[▼] buttons to select an input selector, and then use the Left and Right [◀]/[▶] buttons to select:

- IN1:** Use the video component connected to COMPONENT VIDEO IN 1.
- IN2:** Use the video component connected to COMPONENT VIDEO IN 2.
- IN3:** Use the video component connected to COMPONENT VIDEO IN 3.
- Video:** Output composite video and S-Video sources from the COMPONENT VIDEO OUT.
- Last:** Select this for audio-only components.

5  Press the [Setup] button. The setup menu closes.

Notes:

- If you select Last, the video source remains the same when you select another input selector. For example, if you set VIDEO 1 to Last, select the DVD input selector, then select the VIDEO 1 input selector, you can watch a DVD while listening to audio from the component connected to the VIDEO 1 IN L/R jacks.
- This procedure can also be performed on the AV receiver by using its [Setup] button, arrow buttons, and [Enter] button.

First Time Setup—Continued

Minimum Speaker Impedance (not American models)

This setting is not set automatically by the Automatic Speaker Setup function (see page 39).

If the impedance of any of the connected speakers is 4 ohms or more, but less than 6 ohms, set the Minimum Speaker Impedance to “4 ohms.”

Note:

Before you change this setting, turn down the volume.

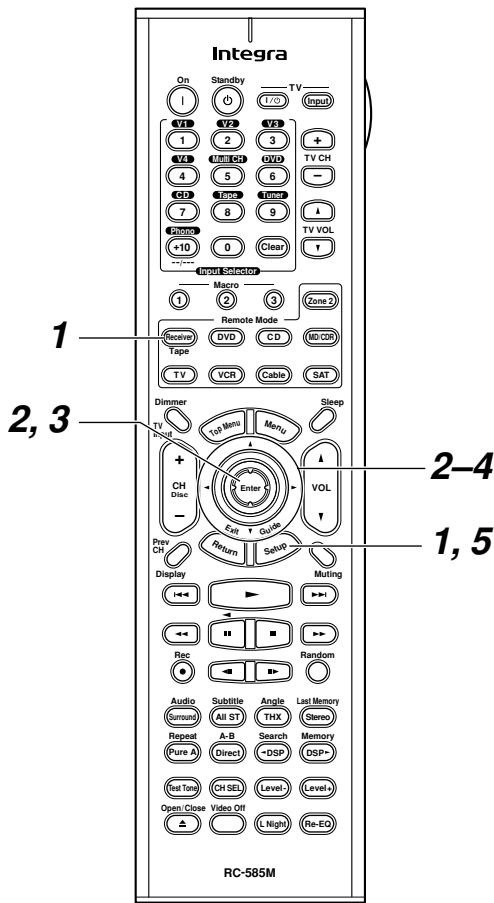

1 Press the [Receiver] button followed by the [Setup] button. The main menu appears onscreen.

2 Use the Up and Down [▲]/[▼] buttons to select “1. Initial Setup,” and then press [Enter]. The Initial Setup menu appears.

3 Use the Up and Down [▲]/[▼] buttons to select “3. Hardware Setup,” and then press [Enter]. The Hardware Setup menu appears.

Menu

1. Initial Setup

1-3. Hardware Setup

a. Powered Zone2 : Not Activated **00**

b. Zone2 Out : Fixed **00**

c. Sp Impedance Minimum : 6ohms **00**

d. TV Format : AUTO **00**

(Menus vary depending on country.)

4 Use the Up and Down [▲]/[▼] buttons to select “b. Sp Impedance Minimum,” and then use the Left and Right [◀]/[▶] buttons to select:

4 ohms: Select if the impedance of any connected speaker is 4 ohms or more, but less than 6 ohms.

6 ohms: Select if the impedances of all connected speakers are between 6 and 16 ohms.

5 Press the [Setup] button. The setup menu closes.



Notes:

- This procedure can also be performed on the AV receiver by using its [Setup] button, arrow buttons, and [Enter] button.

First Time Setup—Continued

TV Format Setup (not American models)

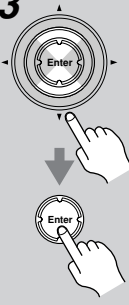
Here you can specify the TV format used in your area.

<p>1</p> 	<p>Press the [Receiver] button followed by the [Setup] button. The main menu appears onscreen.</p>
<p>2</p>	<p>Use the Up and Down [▲]/[▼] buttons to select "1. Initial Setup," and then press [Enter]. The Initial Setup menu appears.</p>
<p>3</p> 	<p>Use the Up and Down [▲]/[▼] buttons to select "3. Hardware Setup," and then press [Enter]. The Hardware Setup menu appears.</p> <div data-bbox="422 940 702 1220" style="border: 1px solid black; padding: 5px; margin: 10px 0;"> <pre> Menu ----- 1. Initial Setup ----- 1-3. Hardware Setup ----- a. Powered Zone2 :Not Activated 00 b. Zone2 Out :Fixed 00 c. Sp Impedance Minimum :6ohms 00 d. TV Format :AUTO 00 </pre> </div> <p>(Menus vary depending on country.)</p>
<p>4</p> 	<p>Use the Up and Down [▲]/[▼] buttons to select "c. TV Format," and then use the Left and Right [◀]/[▶] buttons to select:</p> <p>Auto: Conforms with the video input signal.</p> <p>PAL: Select if the TV system in your area is PAL.</p> <p>NTSC: Select if the TV system in your area is NTSC.</p>
<p>5</p> 	<p>Press the [Setup] button. The setup menu closes.</p>

Note:

- This procedure can also be performed on the AV receiver by using its [Setup] button, arrow buttons, and [Enter] button.

First Time Setup—Continued

Speaker Setup

Some of the settings in this section are set automatically by the Automatic Speaker Setup function (see page 39). Here you can check the settings made by the Automatic Speaker Setup function, or set them manually, which is useful if you change one of the connected speakers after using the Automatic Speaker Setup function.

Speaker Configuration

This setting is set automatically by the Automatic Speaker Setup function (see page 39).

Here you can specify which speakers are connected and their individual sizes.

For speakers with a cone diameter over 6-1/2 inches (16 cm), specify *large*, and for those with a diameter below this, specify *small*.

For the DTR-6.5, if you're using THX-certified speakers, specify *Small* for all speakers.

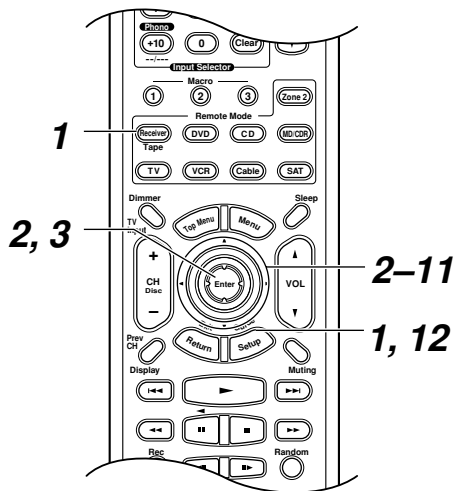
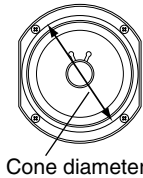

1 Press the [Receiver] button followed by the [Setup] button. The main menu appears onscreen.



2 Use the Up and Down [▲]/[▼] buttons to select "2. Speaker Setup," and then press [Enter]. The Speaker Setup menu appears.

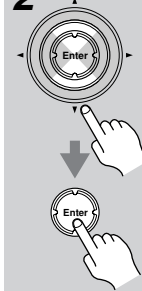

3 Use the Up and Down [▲]/[▼] buttons to select "1. Speaker Config," and then press [Enter]. The Speaker Config menu appears.



Menu	
2. Speaker Setup	
2-1. Speaker Config	
a. Subwoofer	:Yes 00
b. Front	:Large 00
c. Center	:Small 00
d. Surround	:Small 00
e. SurroundBack	:Small 00
f. SurrBack ch	:2ch 00
g. Crossover	:100Hz 00
h. Double Bass	:Off 00

4 Use the Up and Down [▲]/[▼] buttons to select "a. Subwoofer," and then use the Left and Right [◀]/[▶] buttons to select:

Yes: Select if a subwoofer is connected.

No: Select if no subwoofer is connected.

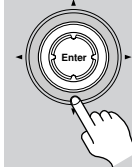

5 Use the Up and Down [▲]/[▼] buttons to select "b. Front," and then use the Left and Right [◀]/[▶] buttons to select:

Small: Select if the front speakers are small.

Large: Select if the front speakers are large.

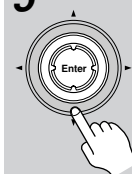

Note:

- If the Subwoofer setting in step 4 is set to No, this setting is fixed at Large.

First Time Setup—Continued

6



Use the Up and Down [▲]/[▼] buttons to select “c. Center,” and then use the Left and Right [◀]/[▶] buttons to select:

Small: Select if the center speaker is small.

Large: Select if the center speaker is large.

None: Select if no center speaker is connected.

Note:

- If the Front setting in step 5 is set to Small, the Large option cannot be selected.

7



Use the Up and Down [▲]/[▼] buttons to select “d. Surround,” and then use the Left and Right [◀]/[▶] buttons to select:

Small: Select if the surround left and right speakers are small.

Large: Select if the surround left and right speakers are large.

None: Select if no surround left and right speakers are connected.

Note:

- If the Front setting in step 5 is set to Small, the Large option cannot be selected.

8



Use the Up and Down [▲]/[▼] buttons to select “e. Surround Back,” and then use the Left and Right [◀]/[▶] buttons to select:

Small: Select if the surround back left and right speakers are small.

Large: Select if the surround back speakers are large.

None: Select if no surround back speakers are connected.

Notes:

- If the Surround setting in step 7 is set to None, this setting cannot be selected.
- If the Surround setting in step 7 is set to Small, this setting cannot be set to Large.

9



Use the Up and Down [▲]/[▼] buttons to select “f. SurrBack ch,” and then use the Left and Right [◀]/[▶] buttons to select:

1ch: Select if one surround back speaker is connected.

2ch: Select if two (left and right) surround back speakers are connected.

Continue with step 10 in the right column.

Crossover

10



Use the Up and Down [▲]/[▼] buttons to select “g. Crossover,” and then use the Left and Right [◀]/[▶] buttons to select a crossover frequency.

Choose a crossover frequency suitable for your setup. If you're using a subwoofer, choose a crossover frequency based on the diameter of your front speakers. If you're not using a subwoofer, use the diameter of any speaker that you specified as Small.

For the DTR-6.5, if you're using THX-certified speakers, select 80Hz (THX).

Speaker cone diameter	Crossover frequency
Over 12 in. (30 cm)	40Hz*
8 to 12 in. (20–30 cm)	60Hz
6-1/2 to 8 in. (16–20 cm)	80Hz (THX)
5-1/4 to 6-1/2 in. (13–16 cm)	100Hz
3-1/2 to 5-1/4 in. (9–13 cm)	120Hz
Under 3-1/2 in. (9 cm)	150Hz

*DTR-6.5 only.

Continue with step 11 on the next page.



- Notes:**
- If the crossover frequency is set to a low value, and the program material doesn't contain any sounds below that frequency, the subwoofer will not output much sound.

First Time Setup—Continued

Double Bass

This setting is not set automatically by the Automatic Speaker Setup function (see page 39).

With the Double Bass function, you can boost bass output by feeding bass sounds from the front left and right channels to the subwoofer. This function can be set only if the Subwoofer setting in step 4 is set to Yes, and the Front setting in step 5 is set to Large.

11	 <p>Use the Up and Down [▲]/[▼] buttons to select “g. Double Bass,” and then use the Left and Right [◀]/[▶] buttons to select: On: Double Bass function on. Off: Double Bass function off (default).</p>
12	 <p>Press the [Setup] button. The setup menu closes.</p>

Notes:



- This procedure can also be performed on the AV receiver by using its [Setup] button, arrow buttons, and [Enter] button.

Speaker Distance

This setting is set automatically by the Automatic Speaker Setup function (see page 39).

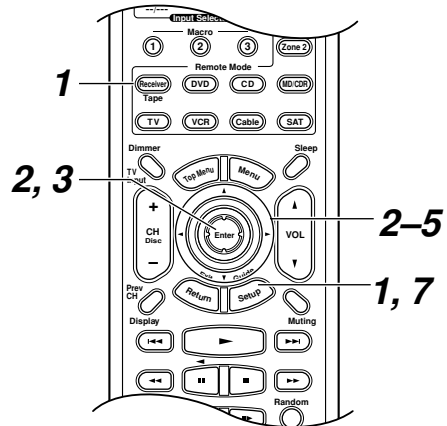
Here you can specify the distance from each speaker to the listening position so that the sound from each speaker arrives at the listener’s ears as the sound designer intended.

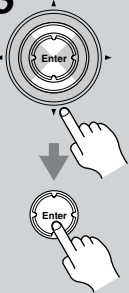

1	 <p>Press the [Receiver] button followed by the [Setup] button. The main menu appears onscreen.</p>
2	 <p>Use the Up and Down [▲]/[▼] buttons to select “2. Speaker Setup,” and then press [Enter]. The Speaker Setup menu appears.</p>
3	 <p>Use the Up and Down [▲]/[▼] buttons to select “2. Speaker Distance,” and then press [Enter].</p>

First Time Setup—Continued

The Speaker Distance menu appears.

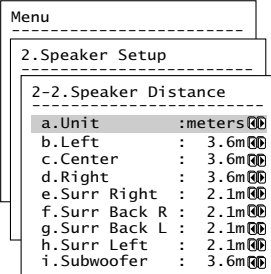

Note:

Speakers that you set to No or None on the Speaker Configuration page (page 46) cannot be selected.

can be set between 15 and 25 ft. (4.5 and 7.5 m). The SurrRight, Surr Left, and Surr Back distances can be set up to 5 ft. (1.5 m) more or 15 ft. (4.5 m) less than the Front distance. For example, if the Front distance is set to 20 ft. (6 m), the SurrRight, Surr Left, and Surr Back distances can be set between 5 and 25 ft. (1.5 and 7.5 m).

- This procedure can also be performed on the AV receiver by using its [Setup] button, arrow buttons, and [Enter] button.

4



Use the Up and Down [▲]/[▼] buttons to select “a. Unit,” and then use the Left and Right [◀]/[▶] buttons to select:

feet: Select if you want to enter distances in feet. Can be set from 1 to 30 feet in 1-foot steps.

meters: Select if you want to enter distances in meters. Can be set from 0.3 to 9 meters in 0.3-meter steps.

5



Use the Up and Down [▲]/[▼] buttons to select “b. Left,” and then use the Left and Right [◀]/[▶] buttons to specify the distance.

Specify the distance from the front left speaker to your listening position.

6

Repeat step 5 for all speakers.

7



Press the [Setup] button.

The setup menu closes.

Notes:

- On the DTR-6.5, if the distance between the furthest and nearest speakers is greater than 20 feet (6 meters), corrected values suitable for home theater use will be set automatically.
- On the DTR-5.5, the Center and Subwoofer distances can be set up to 5 ft. (1.5 m) more or less than the Front distance. For example, if the Front distance is set to 20 ft. (6 m), the Center and Subwoofer distances

First Time Setup—Continued

Speaker Level Calibration

This setting is set automatically by the Automatic Speaker Setup function (see page 39).

Here you can adjust the level of each speaker with the built-in test tone so that the volume of each speaker is the same at the listening position.

Notes:

- The speakers cannot be calibrated while the output of the AV receiver is muted, while a pair of headphones is connected, or when using the multichannel input.
- **Because the DTR-6.5 supports THX, the test tone is output at the standard level of 0 dB (absolute volume setting 82). If you normally listen at volume settings below this, be careful because the test tone will be much louder.**

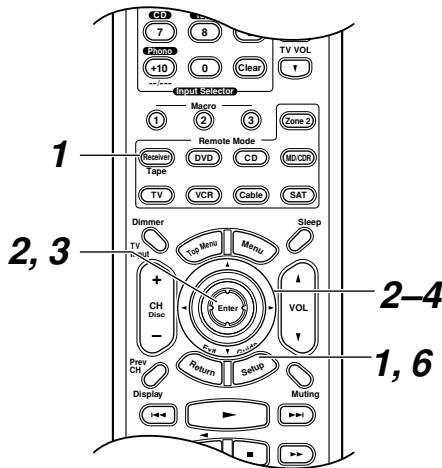

1

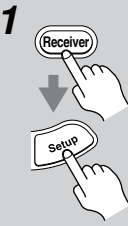

Press the [Receiver] button followed by the [Setup] button.
The main menu appears onscreen.

2

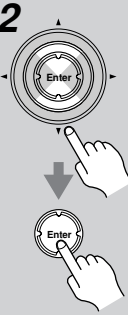

Use the Up and Down [▲]/[▼] buttons to select “2. Speaker Setup,” and then press [Enter].
The Speaker Setup menu appears.

3

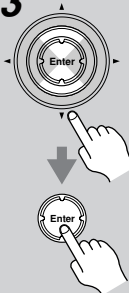

Use the Up and Down [▲]/[▼] buttons to select “3. Level Calibration,” and then press [Enter].
The Level Calibration menu appears and the pink noise test tone is output by the front left speaker.

Menu

2. Speaker Setup

2-3. Level Calibration

a. Left	: 0dB
b. Center	: 0dB
c. Right	: 0dB
d. Surr Right	: 0dB
e. Surr Back R	: 0dB
f. Surr Back L	: 0dB
g. Surr Left	: 0dB
h. Subwoofer	: 0dB

Note:
Speakers that you set to No or None on the Speaker Configuration page (page 46) cannot be selected.

4



Use the Up and Down [▲]/[▼] buttons to select each speaker, and use the Left and Right [◀]/[▶] buttons to set the volume.
The volume can be adjusted from -12 to +12 dB in 1 dB steps (-15 to +12 dB for the subwoofer).

5

Repeat step 4 until the volume of the test tone from each speaker is the same.

6



Press the [Setup] button.
The setup menu closes.

Notes:

- This procedure can also be performed by using the remote controller. First press the [Test Tone] button to output the test tone. Use the [Level-] and [Level+] buttons to set the volume, and use the [CH SEL] button to select the speakers.

First Time Setup—Continued

Equalizer Setting

This setting is set automatically by the Automatic Speaker Setup function (see page 39).

Here you can adjust the EQ of individual speakers. The volume of individual speakers can be set on page 50.

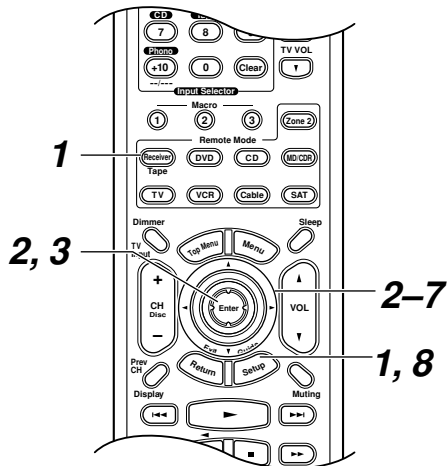

1 Press the [Receiver] button followed by the [Setup] button. The main menu appears onscreen.

2 Use the Up and Down [▲]/[▼] buttons to select "2. Speaker Setup," and then press [Enter]. The Speaker Setup menu appears.

Menu

2. Speaker Setup

1. Speaker Config

2. Speaker Distance

3. Level Calibration

4. Equalizer Settings

3 Use the Up and Down [▲]/[▼] buttons to select "4. Equalizer Settings," and then press [Enter]. The Equalizer Settings menu appears.

4 Use the Left and Right [◀]/[▶] buttons to select:

Off: Tone off, response flat.

Auto: The tone for each speaker is set automatically by the Automatic Speaker Setup function.

Manual: You can adjust the EQ of each speaker manually.

If you select Manual, continue with this procedure. If you select Off or Auto, go to step 8.

5 Use the Down [▼] button to select a speaker.

Menu

2. Speaker Setup

2-4. Equalizer Settings

Use Settings :Manual

← Left →

a. 80Hz : 0dB

b. 250Hz : 0dB

c. 800Hz : 0dB

d. 2.5kHz : 0dB

e. 8kHz : 0dB

6 Use the Up and Down [▲]/[▼] buttons to select a frequency, and then use the Left and Right [◀]/[▶] buttons to adjust the level at that frequency.

The volume at each frequency can be adjusted from -12 to +12 dB in 1 dB steps.

Tip: Low frequencies (e.g., 80Hz) affect bass sounds; high frequencies (e.g., 8kHz) affect treble sounds.

7 Use the Up [▲] button to select "Left," and then use the Left and Right [◀]/[▶] buttons to select another speaker.

Repeat steps 6 and 7 for each speaker.

8 Press the [Setup] button. The setup menu closes.

Notes:

- This procedure can also be performed on the AV receiver by using its [Setup] button, arrow buttons, and [Enter] button.

First Time Setup—Continued

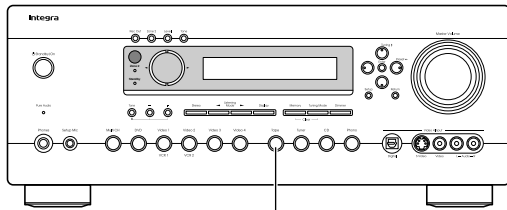

Changing the TAPE/MD/CDR Display

If you connect an **RI**-compatible Integra MiniDisc recorder or CD recorder to the TAPE IN/OUT jacks, for **RI** to work properly, you must change this setting. This setting can only be changed on the AV receiver.



1, 2

(DTR-6.5 shown here)

<p>1</p> <p>Tape</p> 	<p>Press the [TAPE] input selector button so that "TAPE" appears on the display.</p> <div data-bbox="416 1032 743 1088" style="border: 1px solid black; padding: 2px; text-align: center;"> <p>TAPE</p> </div>
<p>2</p> <p>Tape</p> 	<p>Press and hold down the [TAPE] input selector button (about 3 seconds) to set the display.</p> <p>Repeat this step to select TAPE, MD, or CDR.</p> <div data-bbox="416 1279 743 1335" style="border: 1px solid black; padding: 2px; text-align: center;"> <p>MD</p> </div>

Basic Operation

Selecting the Input Source

This section explains how to select the input source (i.e., the AV component that you want to listen to or watch).

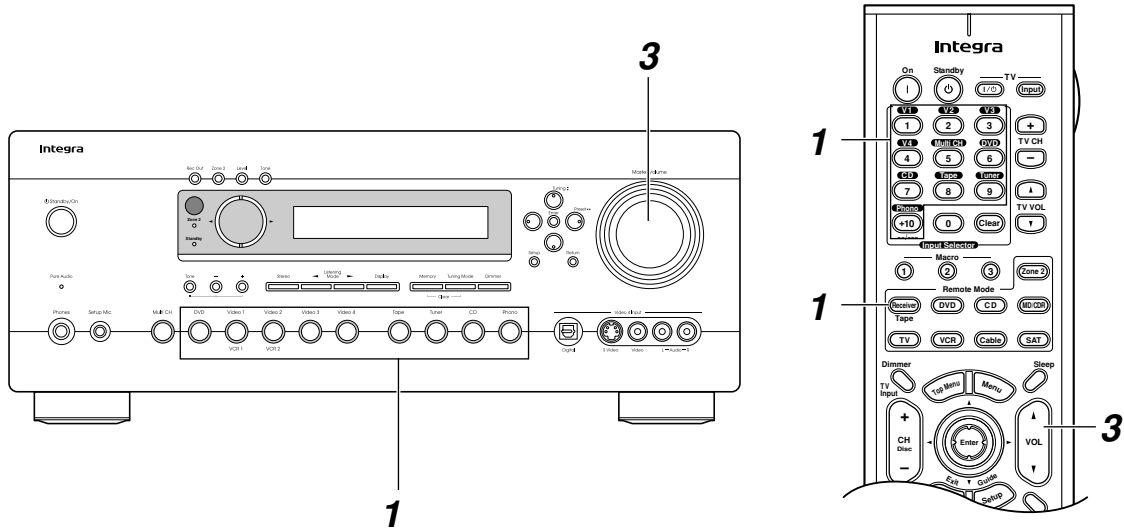

- 1**

AV receiver

Remote controller

Use the AV receiver's input selector buttons to select the input source.

To select the input source with the remote controller, press the [Receiver] button, and then use the Input Selector buttons.

On the remote controller, the [V1], [V2], [V3], and [V4] buttons select the VIDEO 1, VIDEO 2, VIDEO 3, and VIDEO 4 input sources respectively.

Only the RC-585M remote controller has a [PHONO] button.
- 2**

Start playback on the source component.

When you select DVD or another video component, on your TV, you'll need to select the video input that's connected to the AV receiver's MONITOR OUT. On some DVD players, you may need to turn on the digital audio output.
- 3**

AV receiver

Remote controller

To adjust the volume, use the Master Volume control, or the remote controller's [VOL] button.

The volume can be set to MIN, 1 through 99, or MAX.

The AV receiver is designed for home theater enjoyment. It has a wide volume range, allowing precise adjustment.

Basic Operation—Continued

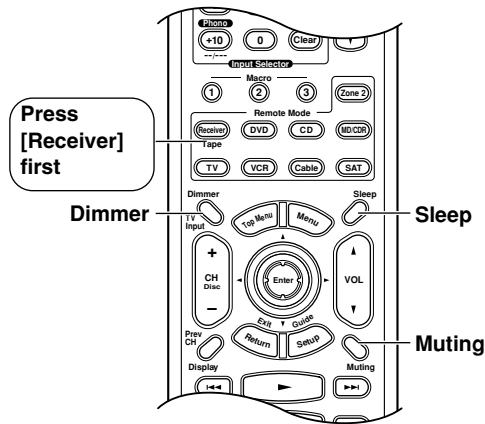

Setting the Display Brightness

You can adjust the brightness of the display.

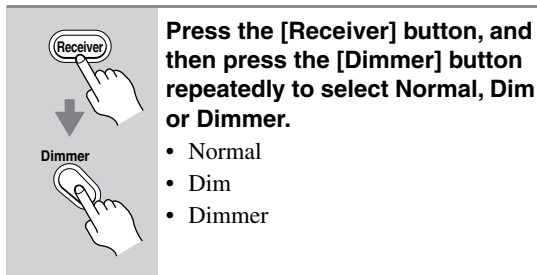

Muting the AV receiver

You can temporarily mute the output of the AV receiver.

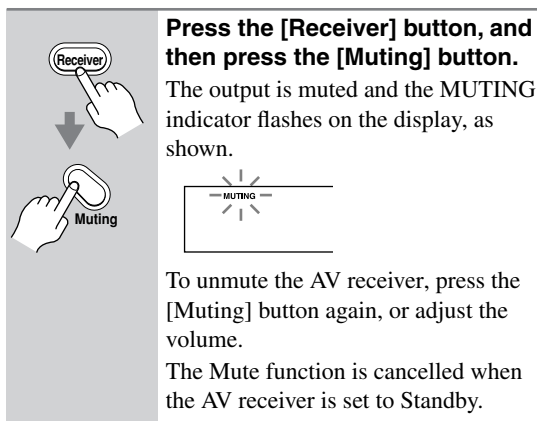

Using the Sleep Timer

With the sleep timer, you can set the AV receiver to automatically turn off after a specified period.

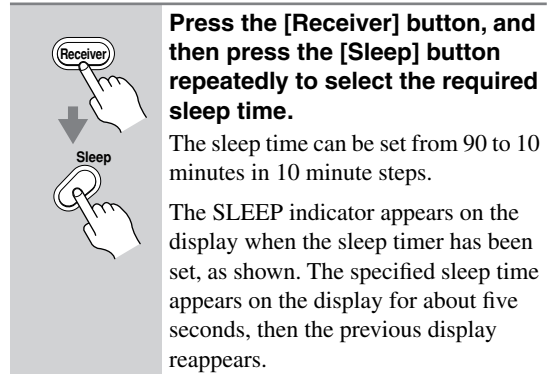

If you need to cancel the sleep timer, press the [Sleep] button repeatedly until the SLEEP indicator disappears.

To check the time remaining until the AV receiver sleeps, press the [Sleep] button. Note that if you press the [Sleep] button while the sleep time is being displayed, you'll shorten the sleep time by 10 minutes.

Using Headphones

You can connect a pair of stereo headphones (1/4-inch phone plug) to the AV receiver's Phones jack for private listening, as shown.

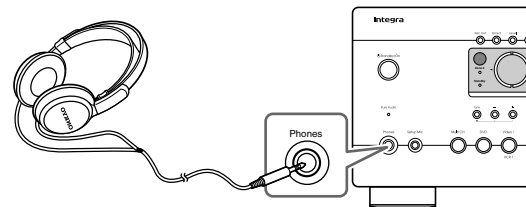

Notes:

- Always turn down the volume before connecting your headphones.
- The speakers are turned off while the headphones plug is inserted in the Phones jack. (Zone 2 speakers are not turned off.)
- When you connect a pair of headphones, the listening mode is set to Stereo, unless it's already set to Stereo, Mono, Direct, or Pure Audio. When you disconnect the headphones, the previous listening mode is resumed.
- Only the Stereo, Direct, Pure Audio, and Mono listening modes can be used with headphones. (The listening modes available also depends on the currently selected input source.)
- When the multichannel input is used, only the front left and right audio can be heard in the headphones. On the DTR-6.5, when the Stereo or Mono listening mode is selected, audio is downmixed for a good sound.

Basic Operation—Continued

Displaying Source Information

You can display various information about the current input source as follows.

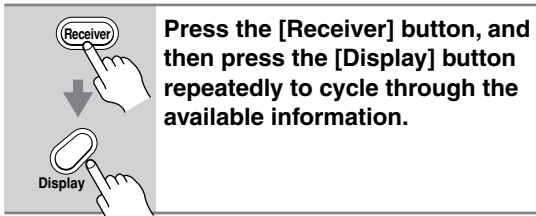
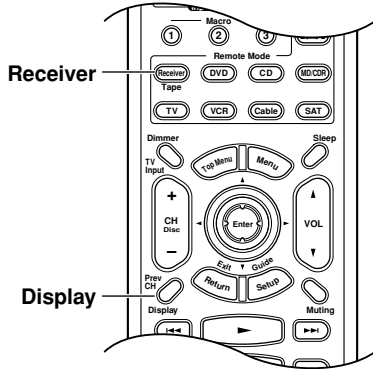

The following information can typically be displayed for input sources.

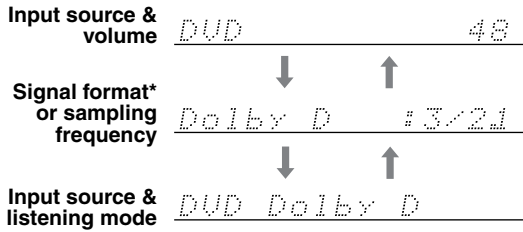

*If the input signal is analog, no format information is displayed. If the input signal is PCM, the sampling frequency is displayed. If the input signal is digital but not PCM, the signal format is displayed. Information is displayed for about three seconds, then the previously displayed information reappears.

Interpreting Surround Channel Values

$$\frac{3}{A} \frac{2}{B} \frac{1}{C}$$

- A: The number of front channels (3 means front left, front right, and center).
- B: The number of surround channels (2 means surround left and surround right). If there's surround back channel information, this will be 3.
- C: LFE channel for subwoofer (1 means yes).

Basic Operation—Continued

Using the Tuner

With the built-in tuner you can enjoy AM and FM radio stations. You can store your favorite stations as presets for quick selection.

Listening to the Radio

1 	<p>Use the [TUNER] input selector button to select either AM or FM. In this example, FM has been selected.</p> <div style="border: 1px solid black; padding: 5px; text-align: center;"> <p>FM 87.50MHz</p> <p>Band Frequency</p> <p>(Actual display depends on country.)</p> </div>
---	---

Manual Tuning Mode

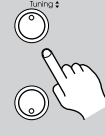
1 	<p>Press the [Tuning Mode] button so that the AUTO indicator disappears from the display.</p>
2 	<p>Press and hold the Tuning Up or Down [▲]/[▼] button. The frequency stops changing when you release the button. Press the buttons repeatedly to change the frequency one step at a time.</p>

The American model changes FM frequency in 0.2 MHz steps, 10 kHz steps for AM. For other models it's 0.05 MHz steps for FM and 9 kHz steps for AM. In Manual Tuning mode, FM stations will be in mono.

Tuning into Radio Stations

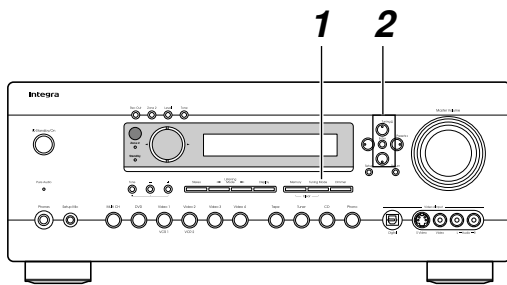

Tuning into weak FM stereo stations

If the signal from a stereo FM station is weak, it may be impossible to get good reception. In this case, switch to Manual Tuning mode and listen to the station in mono.

Auto Tuning Mode

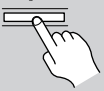
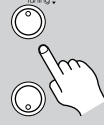
1 	<p>Press the [Tuning Mode] button so that the AUTO indicator appears on the display.</p>
2 	<p>Press the Tuning Up or Down [▲]/[▼] button. Searching stops when a station is found.</p>

When tuned into a station, the TUNED indicator appears. When tuned into a stereo FM station, the FM STEREO indicator appears on the display, as shown.

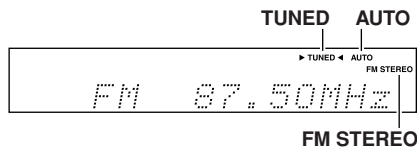

Basic Operation—Continued

Presetting Radio Stations

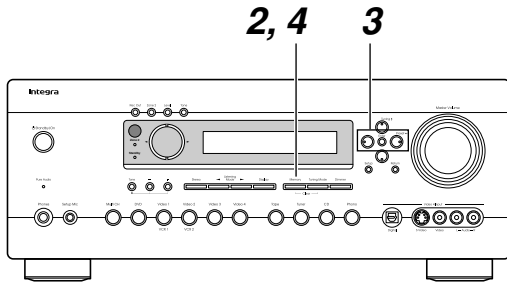

You can store up to 40 of your favorite radio stations as presets.

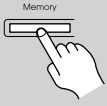
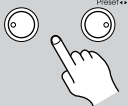
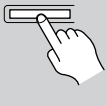
- | | |
|---|---|
| 1 | Tune into the station that you want to store as a preset. |
| 2
 | Press the [Memory] button.
The MEMORY indicator appears and the preset number flashes. |
| 3
 | While the MEMORY indicator is displayed (about 8 seconds), use the Preset [◀]/[▶] buttons to select a preset from 1 through 40.
In this example, preset #3 is selected. |
| 4
 | Press the [Memory] button again to store the station.
The station is stored and the preset number stops flashing. |
| | Repeat this procedure for all your favorite radio stations. |

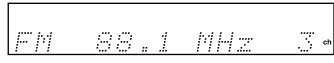
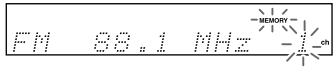

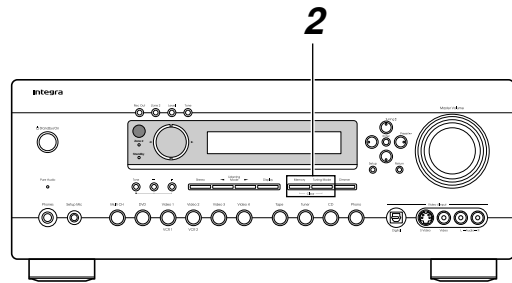

Deleting Presets

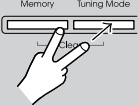

- | | |
|---|--|
| 1 | Select the preset that you want to delete.
See the previous section. |
| 2
 | While holding down the [Memory] button, press the [Tuning MODE] button.
The selected preset is deleted and its number disappears from the display. |

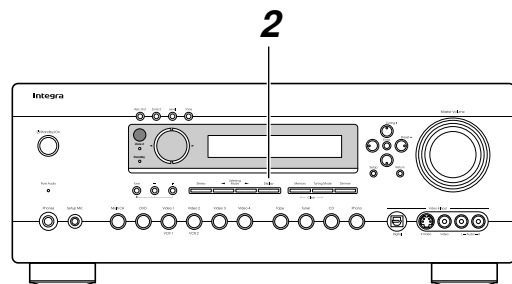
Displaying Radio Information



- | | |
|---|--|
| 1
 | Press the [Display] button repeatedly to cycle through the available information. |
|---|--|

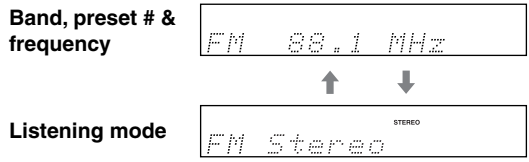

Selecting Preset Stations

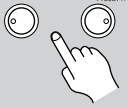
- | | |
|---|---|
| 1
 | Use the [TUNER] input selector button to select either AM or FM. |
| 2
 | Use the Preset [◀]/[▶] buttons, or the remote controller's CH [+/-] button to select a preset. |

Basic Operation—Continued

Selecting Listening Modes

See “About the Listening Modes” on page 60 for detailed information about the listening modes.

- The Dolby Digital and DTS listening modes can only be selected if your DVD player is connected to the AV receiver with a digital audio connection (coaxial or optical).
- Listening mode availability depends on the format of the current input signal.

Selecting on the AV receiver

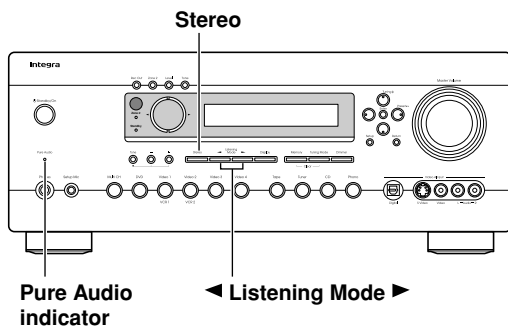

- **[Stereo] button**
This button selects the Stereo listening mode.
- **Listening Mode [◀] [▶] buttons**
These buttons select all the listening modes that can be used with the current input source. Modes can be selected in the following order, depending on the input signal format:
Pure Audio → Direct → Mono → Stereo → Surround (e.g., PLIIx, Neo:6, Dolby D EX, DTS/DTS 96/24, DTS-ES, and so on) → Onkyo original DSP

Selecting with the Remote Controller

RC-585M

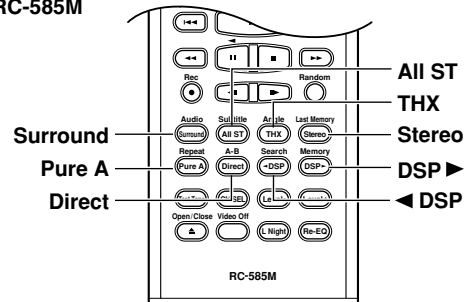

RC-586M

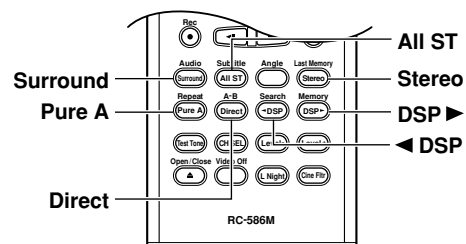

- **[Surround] button**
This button selects the Dolby Digital, Pro Logic IIx, Neo:6, DTS, and other listening modes.
- **[All ST] button**
This button selects the All Ch Stereo listening mode.
- **[THX] button (DTR-6.5 only)**
This button selects the THX listening modes.
- **[Stereo] button**
This button selects the Stereo listening mode.
- **[Pure A] button**
This button selects the Pure Audio listening mode. When this mode is selected, the Pure Audio indicator lights up, the AV receiver outputs no video signals, and its display is turned off.
- **[Direct] button**
This button selects the Direct listening mode.
- **[◀ DSP] & [DSP ▶] buttons**
These buttons select the Onkyo original DSP modes.

Basic Operation—Continued

The following table lists all the listening modes and shows which modes can be selected for each input signal format.

Input signal format	Analog, PCM*1	Dolby D				DTS/DTS 96/24*2					Multich
		*2	2/0	1/0,1+1	Other	*2	2/0	1/0, 1+1	Other	DTS-ES	
Source	CD, TV, LD, VHS, MD, turntable, radio, cassette, DTV, etc.	DVD, DTV, etc.				DVD, LD, CD, etc.					DVD
Listening mode											
Pure Audio	<input type="radio"/>	<input type="radio"/>	<input type="radio"/>	<input type="radio"/>	<input type="radio"/>	<input type="radio"/>	<input type="radio"/>	<input type="radio"/>	<input type="radio"/>	<input type="radio"/>	<input type="radio"/>
Direct	<input type="radio"/>	<input type="radio"/>	<input type="radio"/>	<input type="radio"/>	<input type="radio"/>	<input type="radio"/>	<input type="radio"/>	<input type="radio"/>	<input type="radio"/>	<input type="radio"/>	<input type="radio"/>
Stereo	<input type="radio"/>	<input type="radio"/>	<input type="radio"/>	<input type="radio"/>	<input type="radio"/>	<input type="radio"/>	<input type="radio"/>	<input type="radio"/>	<input type="radio"/>	<input type="radio"/>	<input type="radio"/> *3
Mono	<input type="radio"/>	<input type="radio"/>	<input type="radio"/>	<input type="radio"/>	<input type="radio"/>	<input type="radio"/>	<input type="radio"/>	<input type="radio"/>	<input type="radio"/>	<input type="radio"/>	<input type="radio"/> *3
PLIIx Movie/Music/Game *4	<input type="radio"/>		<input type="radio"/>				<input type="radio"/>				
Neo:6 Cinema	<input type="radio"/>		<input type="radio"/>				<input type="radio"/>				
Neo:6 Music *5	<input type="radio"/>		<input type="radio"/>				<input type="radio"/>				
Dolby D		<input type="radio"/>			<input type="radio"/>						
Dolby D EX *6		<input type="radio"/>									
Dolby D+PLIIx Movie *7		<input type="radio"/>									
Dolby D+PLIIx Music *6		<input type="radio"/>									
DTS, DTS 96/24						<input type="radio"/>			<input type="radio"/>	<input type="radio"/> *8	
DTS+Neo:6 *6						<input type="radio"/>					
DTS+Dolby EX *6						<input type="radio"/>					
DTS+PLIIx Movie *7, Music *6						<input type="radio"/>					
DTS-ES Discrete *6										Discrete	
DTS-ES Matrix *6										Matrix	
Multich											<input type="radio"/>
Multich+Dolby EX *6											<input type="radio"/> *3
Multich+PLIIx Movie *7, Music *6											<input type="radio"/> *3
*9 PLIIx+THX Cinema *4	<input type="radio"/>		<input type="radio"/>				<input type="radio"/>				
*9 Neo:6+THX Cinema	<input type="radio"/>										
*9 THX Cinema		<input type="radio"/>			<input type="radio"/>	<input type="radio"/>			<input type="radio"/>	<input type="radio"/> *8	<input type="radio"/> *3
*9 THX SurrEX *6		<input type="radio"/>				<input type="radio"/>					<input type="radio"/> *3
*9 PLIIx+THX Cinema *7		<input type="radio"/>				<input type="radio"/>					<input type="radio"/> *3
*9 DTS+Neo:6+THX Cinema *6						<input type="radio"/>					
*9 DTS-ES+THX Cinema *6										<input type="radio"/>	
Mono Movie											
Enhance											
Orchestra	<input type="radio"/>	<input type="radio"/>	<input type="radio"/>	<input type="radio"/>	<input type="radio"/>	<input type="radio"/>	<input type="radio"/>	<input type="radio"/>	<input type="radio"/>	<input type="radio"/>	<input type="radio"/> *3
Unplugged											
Studio-Mix											
TV Logic											
All Ch Stereo	<input type="radio"/>	<input type="radio"/>	<input type="radio"/>	<input type="radio"/>	<input type="radio"/>	<input type="radio"/>	<input type="radio"/>	<input type="radio"/>	<input type="radio"/>	<input type="radio"/>	<input type="radio"/> *3
Full Mono	<input type="radio"/>	<input type="radio"/>	<input type="radio"/>	<input type="radio"/>	<input type="radio"/>	<input type="radio"/>	<input type="radio"/>	<input type="radio"/>	<input type="radio"/>	<input type="radio"/>	<input type="radio"/> *3
Theater-Dimensional	<input type="radio"/>	<input type="radio"/>	<input type="radio"/>	<input type="radio"/>	<input type="radio"/>	<input type="radio"/>	<input type="radio"/>	<input type="radio"/>	<input type="radio"/>	<input type="radio"/>	<input type="radio"/> *3

1. In the Pure Audio and Direct listening modes, PCM signals at 32 kHz, 44.1 kHz, and 48 kHz are processed at 64 kHz, 88.2 kHz, and 96 kHz respectively. 96 kHz signals are processed at 48 kHz for all listening modes other than Pure Audio, Direct, and Stereo.
2. In the Pure Audio, Direct, Stereo, and DTS 96/24 listening modes, signals are processed as DTS 96/24. Everything else processed as DTS.
3. DTR-6.5 only.
4. If the SurrBack parameter is set to "None," or the Zone 2 speakers are being used, PLII is used.
5. Available only when Surround speakers are connected.
6. Cannot be selected if the SurrBack parameter is set to "None" or the Zone 2 speakers are being used.
7. Cannot select if the SurrBack ch setting is not set to "2ch," or the Zone 2 speakers are being used.
8. If the SurrBack setting is set to "None," or the Zone 2 speakers are being used, DTS is used.
9. DTR-6.5 only.

Basic Operation—Continued

About the Listening Modes

With its built-in surround-sound decoders and DSP programs, the AV receiver can transform your home listening room into a movie theater or concert hall.

If you connect two surround back speakers (i.e., left and right), both will be used for 6.1-channel surround playback.

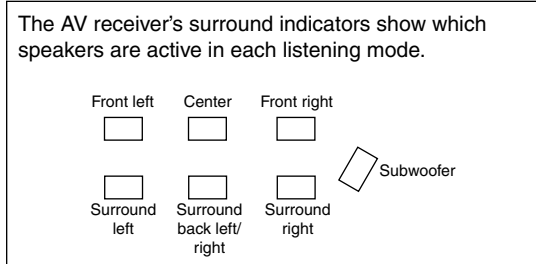

Direct

The selected input source is output by the front left and right speakers only, with minimal processing for a pure sound.

Pure Audio

As an extension of Direct mode, this mode turns off the display, turns off the power to the video circuitry, and minimizes any other possible noise sources, providing a high fidelity sound that's true to the original. (Since the power to the video circuitry is turned off, no video signals are output while this mode is selected.)

Stereo

The selected input source is processed as a stereo signal and output by the front left and right speakers and the subwoofer.

Mono or

Use this mode when watching an old movie with a mono soundtrack, or to select multilingual soundtracks recorded in the left and right channels of some movies. It can also be used when playing a DVD or other source with multiplexed audio, such as a karaoke DVD.

T-D (Theater-Dimensional) or

With this mode you can enjoy a virtual 5.1 surround sound even with only two or three speakers. This works by controlling how sounds reach the listener's left and right ears. Good results may not be possible if there's too much reverb, so we recommend that you use this mode in an environment with little or no natural reverb.

Dolby Pro Logic II Movie

Use this mode with DVDs and videos that bear the Dolby Surround  logo or TV programs that feature Dolby Surround. You can also use this mode with stereo movies or TV programs and the AV receiver will create a 5.1 surround mix from the 2-channel stereo.

Dolby Pro Logic II Music

Use this mode to add 5.1 surround to stereo sources such as music CDs and DVDs.

Dolby Pro Logic IIx

If you've connected surround back speakers to the AV receiver, Dolby Pro Logic IIx allows you to enjoy 7.1-channel playback from 2-channel or 5.1-channel music or movies. Dolby Pro Logic IIx provides a well defined, natural multichannel surround-sound experience, putting the listener in a seamless envelope of sound. The added drama and natural sound enhance the listening experience with CDs, movies, and games.

Dolby Pro Logic IIx has three modes of operation: Movie mode for movies, Music mode for listening to music, and Game mode for use with games consoles with 2-channel stereo outputs.

Dolby Digital

With this format you can experience the same superb sound that you get at a movie theater or concert hall. Use this mode with DVDs that bear the Dolby Digital logo. 

Dolby Digital EX

With an added surround-back channel, this 6.1 channel format offers a heightened sense of space, for added realism with moving sounds, such as those that rotate 360 degrees or pass overhead. Dolby Digital EX material can also be played on conventional 5.1 channel systems, in which case the surround-back channel audio is split between the surround left and right channels. Use this mode with DVDs that have a 5.1-channel soundtrack and bear the Dolby Digital logo. 

DTS

This digital surround format offers a surround sound experience with exceptional fidelity. It uses compressed digital audio data, with six discrete channels (5.1), and the ability to handle large amounts of audio data while remaining faithful to the original. DTS provides very high-quality sound. You'll need a DTS compatible DVD player in order to enjoy DTS material. Use this mode with DVDs, LDs, or CDs that bear the DTS logo. 

DTS 96/24

This mode provides higher audio quality. Use it with CDs, DVDs, and LDs that bear the DTS 96/24 logo. 

DTS-ES Discrete

This is DTS with an added surround back channel for 6.1 surround sound. Use it with program material recorded in DTS 6.1 format. With the additional surround back channel, this format offers 6.1 fully independent digital channels, providing a realistic sense of movement and space. Use it with program material recorded in DTS 6.1, such as CDs, DVDs, or LDs that bear the DTS-ES logo. 

Basic Operation—Continued

DTS-ES Matrix

This is DTS with an added surround back channel for 6.1 surround sound. Use it to provide 6.1 channel surround playback with program material recorded in DTS 5.1 format. Since DTS 5.1 program material contains surround back channel information, all channels can be reconstructed for 6.1-channel playback. Use this mode with CDs, DVDs, or LDs that bear the DTS-ES or DTS logo.



Neo:6

This mode provides 6.1-channel playback from 2-channel sources. It offers six full-bandwidth channels with excellent separation. There are two modes of operation: Cinema mode for movies, and Music mode for listening to music.

Cinema mode simulates the realistic sense of movement that you get with 6.1-channel surround sound sources. Use this mode with videos, DVDs, and TV programs that feature stereo sound.

Music mode uses the surround channels to simulate a natural sound field that cannot be produced with conventional stereo. Use this mode with stereo material such as music CDs.

THX Cinema (DTR-6.5 only) or

THX Ltd, founded by George Lucas, develops quality assurance programs for ensuring that movies are reproduced in movie theaters and home theaters just as the director intended. THX technology is used to eliminate spatial errors that can occur when a movie soundtrack is adapted for use in smaller home theaters, ensuring faithful reproduction.

This mode is ideal for watching a movie with a soundtrack recorded and edited especially for playback in the spaciousness of a typical movie theater.

THX Surround EX (DTR-6.5 only)

This format was jointly developed by Dolby Laboratories and THX Ltd. especially for home theater use. It's based on Dolby Digital EX technology. It adds an extra surround channel to the existing front left, front right, center, surround left, surround right, and LFE (subwoofer) channels, making a total of 6.1 channels. (For best results with DVDs that feature THX Surround EX, use a THX-certified THX speaker system.)

Onkyo Original DSP Modes

Orchestra or

Suitable for classical or operatic music. The center speaker is turned off and the surround channels are emphasized in order to widen the stereo image. In addition, it simulates the natural reverberation of a large hall.

Unplugged

Suitable for acoustic instrument sounds, vocals, and jazz music. By emphasizing the front stereo image, it simulates the stage-front experience.

Studio-Mix

Suitable for rock and pop music. Listening to music in this mode creates a lively sound field with a powerful acoustic image, like being at a club or rock concert.

TV Logic

Adds realistic acoustics to TV programs produced in a TV studio. In addition, it adds surround effects to the entire sound and adds clarity to voices.

Enhance

This mode is ideal for enjoying music programs or TV sports programs. It provides a natural surround sound with movement in the surround back speakers, creating a sound with a live feeling to it.

Mono Movie

This mode is suitable for use with old movies and other mono sound sources. The center speaker outputs the sound as it is, while reverb is applied to the sound output by the other speakers, giving presence to even mono material.

All Ch Stereo

Ideal for background music. The front, surround, and surround back channels create a stereo image that fills the entire listening area.

Full Mono

In this mode, all speakers output mono audio, so the music sounds the same regardless of where you are.

Advanced Operation

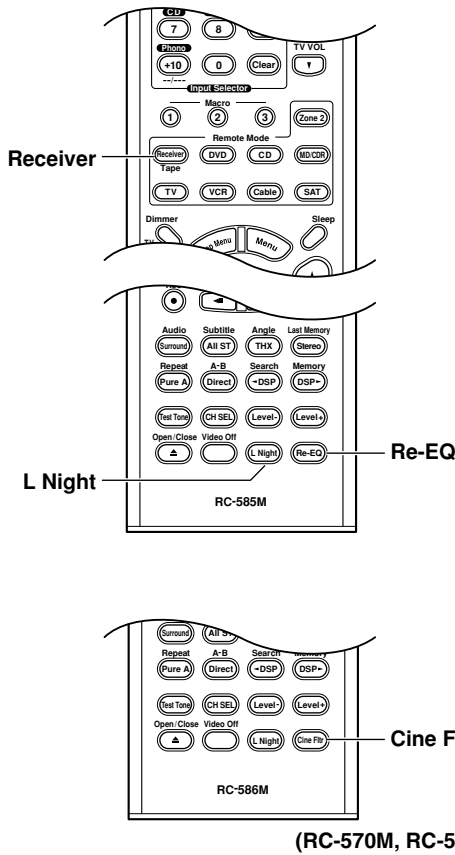

(RC-570M, RC-591M)

Using the Re-EQ Function (DTR-6.5 only)

With the Re-EQ function, you can correct a soundtrack whose high-frequency content is too harsh, making it more suitable for home theater viewing. This function can be used with the following listening modes: Dolby Digital, Dolby Digital EX, Dolby Pro Logic IIx Movie, DTS, DTS-ES, DTS Neo:6 Cinema, DTS 96/24, DTS+Neo:6, and DTS+Dolby EX.

1 Press the [Receiver] button followed by the [Re-EQ] button. Press the button again to turn off the Re-EQ function.

- Notes:**
- By default, the Re-EQ function is off.

Using the CinemaFILTER (DTR-5.5 only)

With the CinemaFILTER, you can soften overly bright movie soundtracks, which are typically mixed for reproduction in a movie theater. CinemaFILTER can be used with the following listening modes: Dolby Digital, Dolby Digital EX, Dolby Pro Logic IIx Movie, DTS, DTS-ES, DTS Neo:6 Cinema, DTS 96/24, DTS+Neo:6, and DTS+Dolby EX.

1 Press the [Receiver] button, and then press the [Cine Fitr] button repeatedly to select:

- On:** CinemaFILTER on.
- Off:** CinemaFILTER off.

Using the Late Night Function (Dolby Digital only)

With the Late Night function, you can reduce the dynamic range of Dolby Digital material so that you can still hear quiet parts even when listening at low volume levels—ideal for watching movies late at night when you don't want to disturb anyone.

1 Press the [Receiver] button, and then press the [L NIGHT] button repeatedly to select:

- Off:** Late Night function off.
- Low:** Small reduction in dynamic range.
- High:** Big reduction in dynamic range.

- Notes:**
- The effect of the Late Night function depends on the Dolby Digital material that you are playing, and with some material there will be little or no effect.
 - The Late Night function is set to Off when the AV receiver is set to Standby.

Advanced Operation—Continued

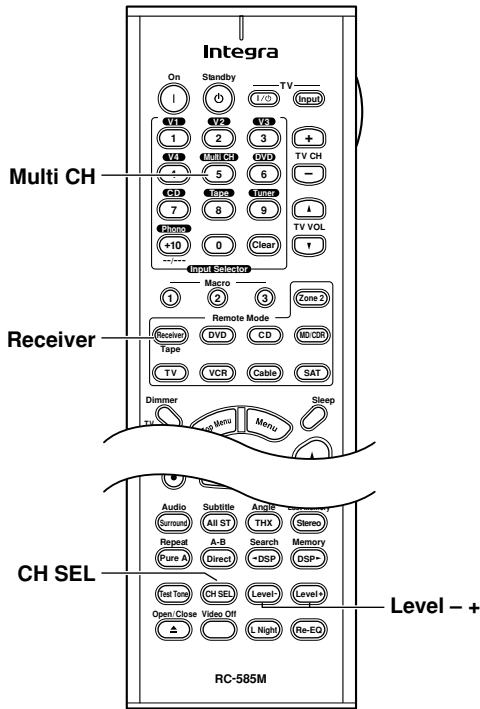

Adjusting Individual Speaker Levels

You can adjust the level of individual speakers during playback. These adjustments are temporary and will be cancelled when the AV receiver is set to Standby.

1 Press the [Receiver] button, use the [CH SEL] button to select each speaker, and use the [Level-] and [Level+] buttons to adjust the volume.

Speakers are selected in the following order: Front Left → Center → Front Right → Surr Right → Surr Back Right → Surr Back Left → Surr left → Subwoofer.

You can adjust the volume of each speaker from -12 dB to +12 dB (-15 dB to +12 dB for the subwoofer). The name of the currently selected speaker and its volume appear on the display, as shown.

Notes:

- You cannot use this function while the AV receiver is muted.
- Speakers that are set to No or None in the Speaker Configuration cannot be adjusted.

Using the DVD Analog Multichannel Input

The DVD analog multichannel input is for connecting components with a 5.1-channel analog audio output, such as a DVD player or MPEG decoder.

See “Using a Multichannel Connection” on page 29 for connection information.

1 Press the [Receiver] button followed by the [Multi CH] button so that “MCH” appears on the display.

Notes:

- To use the bass and treble functions with the DVD analog multichannel input, select the Multich listening mode first.

Adjusting Individual Speaker Levels

You can adjust the level of individual speakers while using the DVD analog multichannel input.

1 Use the remote controller’s [CH SEL] button to select each speaker, and then use the [Level-] and [Level+] buttons to adjust the volume.

The level can be adjusted from -12 to +12 dB (-30 to +12 dB for the subwoofer).

Notes:

- These speaker level settings are completely independent of those explained on pages 50 and left column.
- While the DVD analog multichannel input is selected, you can only select the Direct, Pure Audio, or Multich listening mode. If you select the DVD analog multichannel input while using another listening mode, that listening mode will be cancelled.
- While the DVD analog multichannel input is selected, the Automatic Speaker Setup and Speaker Configuration settings on page 46 are ignored, and signals from the multichannel input are fed to the front left, front right, center, surround left, and surround right speakers, and subwoofer regardless of those settings.
- On the DTR-6.5, you can select the listening modes as explained on page 59. In addition, sound is output by the surround back speakers.

Advanced Operation—Continued

Recording

This section explains how to record the current input source, how to record one input source while enjoying another, and how to dub audio onto your video recordings.

Unless you have the full consent of the copyright holder, copyright laws prohibit using your recordings for anything other than personal enjoyment!

Notes:

- The surround sound and DSP listening modes cannot be recorded.
- Copy-protected DVDs cannot be recorded.
- You cannot record from the DVD analog multichannel input.
- Various restrictions apply to digital recording. Refer to the manuals supplied with your digital recording equipment for more details.
- Digital input signals are output by only the digital outputs, and analog input signals are output by only the analog outputs. There is no internal conversion from digital to analog or vice versa.
- DTS signals will be recorded as noise, so don't attempt analog recording of DTS CDs or LDs.

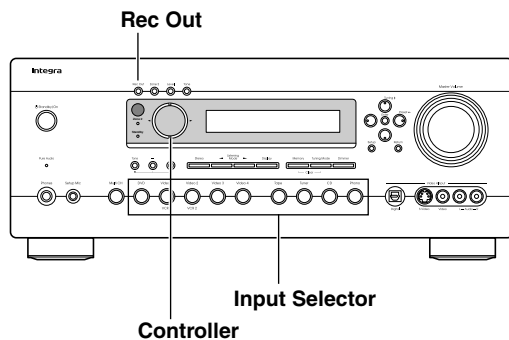

Recording Audio

You can record the current audio source as follows.

1	Use the input selector buttons to select the audio component that you want to record.

2		<p>Press the [Rec Out] button, and then use the Controller [◀]/[▶] buttons to select “Rec Sel : Source.”</p> <p>The current input source can be recorded by the recorder connected to the TAPE OUT.</p>
3		<p>Start recording on the recorder.</p> <p>See your recorder's manual for more information.</p>
4		<p>Start playback on the source component.</p> <p>If you select another input source during recording, that input source will be recorded.</p>

Recording Audio & Watching a Separate AV Source at the Same Time

While recording audio, you can watch a completely separate AV Source at the same time. For example, you could watch a DVD while recording a CD to tape.

1		<p>Press the [Rec Out] button.</p>
2		<p>Within five seconds, use the Controller [◀]/[▶] buttons to select the audio input source that you want to record (you cannot select TAPE).</p> <p>The name of the input source selected for recording appears on the display.</p> <p>The specified input source can now be recorded by the recorder connected to the TAPE OUT.</p>
3		<p>Start recording on the recorder.</p> <p>See your recorder's manual for more information.</p>
4		<p>Start playback on the audio source component.</p>

Notes:

- Since the Zone 2 function and the REC OUT outputs use the same circuitry, you cannot record from a separate source and use Zone 2 at the same time.
- To turn off the REC OUT output (i.e., the TAPE OUT), press the [Rec Out] button, and then use the Controller [◀] [▶] buttons to select “OFF.”

Advanced Operation—Continued

AV Recording

You can record AV input sources to an AV recording component (VCR, etc) connected to the VIDEO 1 OUT or VIDEO 2 OUT. See pages 27–38 for information on connecting components.

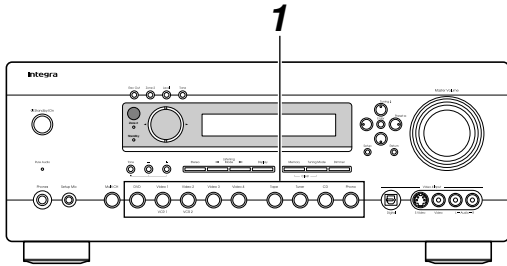

1	<p>Use the input selector buttons to select the AV component that you want to record.</p> <p>Audio signals from the selected input source are output by the VIDEO 1 OUT and VIDEO 2 OUT only.</p> <p>You can watch the source while recording, and the AV receiver's VOLUME control has no effect on recording.</p>
2	<p>Start recording on the AV component connected to the VIDEO 1 OUT or VIDEO 2 OUT.</p>
3	<p>Start playback on the source AV component.</p> <p>If you select another input source during recording, that input source will be recorded.</p>

Recording Separate AV Sources

Here you can record audio and video from completely separate sources, allowing you to overdub audio onto your video recordings. This function takes advantage of the fact that when an audio-only input source (i.e., TAPE, TUNER, or CD) is selected, the video input source remains unchanged.

In the following example, audio from the CD player connected to the CD IN, and video from the camcorder connected to the VIDEO 4 INPUT VIDEO jack are recorded by the VCR connected to the VIDEO 1 OUT jacks.

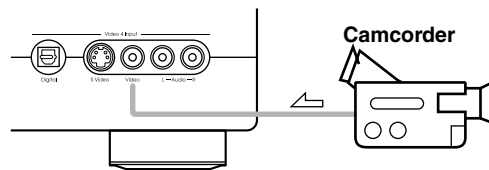

↔ : video signal
 ▲ : audio signal

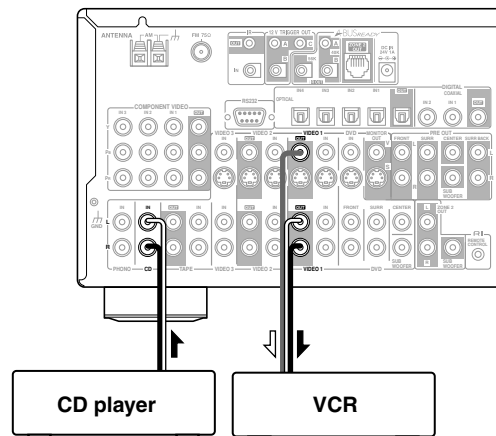







- 1** Prepare the camcorder and CD player for playback.
- 2** Prepare the VCR for recording.
- 3** Press the [VIDEO 4] input selector button.
- 4** Press the [CD] input selector button.
 This selects the CD player as the audio source, but leaves the camcorder as the video source.
- 5** Start recording on the VCR and start playback on the camcorder and CD player.
 The video from the camcorder and the audio from the CD player are recorded by the VCR.

Advanced Setup

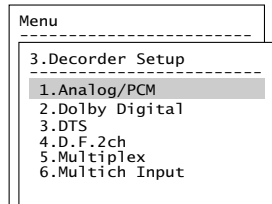
Decoder Setup

Here are surround-related settings for PCM, Dolby Digital, multichannel, and other input signal formats.

<p>1</p> 	<p>Press the [Receiver] button followed by the [Setup] button. The main menu appears onscreen.</p>
<p>2</p> 	<p>Use the Up and Down [▲]/[▼] buttons to select "3. Decoder Setup," and then press [Enter]. The Surround Setup menu appears.</p> 
<p>3</p> 	<p>Use the Up and Down [▲]/[▼] buttons to select the menu items, and then press [Enter].</p>
<p>4</p> 	<p>Use the Up and Down [▲]/[▼] buttons to select the settings, and use the Left and Right [◀]/[▶] buttons to set them. The settings are explained below.</p>
<p>5</p> 	<p>When you've finished, press the [Setup] button. The setup menu closes.</p>

Note:

- This procedure can also be performed on the AV receiver by using its [Setup] button, arrow buttons, and [Enter] button.

- The Surround Mode and SurrBack Mode settings can also be changed by using the remote controller's [SURR] button.
- The THX Mode settings can also be changed by using the remote controller's [THX] button (DTR-6.5 only).

3-1. Analog/PCM

These settings apply to PCM input signals from CD players and so on, and analog signals from cassette players, turntables, and so on.

■ a. Input Channel (Mono)

This setting determines which channel is output when the Mono listening mode is used with a stereo source.

L+R: Both the left and right channels are output (default).

Left: Only the left channel is output.

Right: Only the right channel is output.

■ b. Surround Mode

This setting determines the surround mode for analog and PCM input signals. This setting is unavailable if no center and surround speakers are connected.

You can select PLIIX Movie (default), PLIIX Music, PLIIX Game, Neo:6 Cinema, or Neo:6 Music.

■ c. THX Mode (DTR-6.5 only)

This setting determines which surround mode is used when THX is used with analog and PCM input signals. This setting is unavailable if no surround speakers are connected.

You can select either PLIIX+THX (default) or Neo:6+THX.

If you're not using any surround back speakers, "PLIIX" will be "PLII."

If you're not using any surround speakers, Neo:6 Music cannot be selected.

3-2. Dolby Digital

These settings apply to Dolby Digital input signals.

■ a. LFE Level

With this setting, you can set the level of the LFE (Low Frequency Effects) channel for Dolby Digital sources to $-\infty$, -10 dB, or 0 dB (default).

If you find that the low-frequency effects are too loud when playing Dolby Digital sources, set this to -10 dB or $-\infty$ dB.

■ b. Dolby EX

This setting determines how Dolby Digital EX signals are handled. This setting is unavailable if no surround back speakers are connected.

Auto: If the source signal contains a Dolby Digital EX flag, the Dolby Digital EX listening mode is used.

Manual: Depends on the c. SurrBack Mode setting and d. THX Mode setting.

Advanced Setup—Continued

■ c. SurrBack Mode

This setting determines which surround mode is used for Dolby Digital input signals that don't contain a Dolby Digital EX flag, or when the b. Dolby EX setting is set to Manual. This setting is unavailable if no surround back speakers are connected.

You can select PLIIx Movie (default), PLIIx Music, or Dolby D, or Dolby D EX.

- If only one surround back speaker is connected, PLIIx Movie is unavailable.

■ d. THX Mode (DTR-6.5 only)

This setting determines which surround mode is used when THX is used with Dolby Digital input signals. This setting is unavailable if no surround back speakers are connected.

You can select THX SurrEX (default), PLIIx+THX, or THX Cinema.

- If only one surround back speaker is connected, PLIIx+THX is unavailable.

3-3. DTS

These settings apply to DTS input signals.

■ a. LFE Level

With this setting you can set the level of the LFE (Low Frequency Effects) channel for DTS sources to $-\infty$, -10 dB, or 0 dB (default).

If you find that the low-frequency effects are too loud when playing DTS sources, set this to -10 dB or $-\infty$ dB.

■ b. SurrBack Mode

This setting determines which surround mode is used for DTS input signals that are not DTS-ES. (The handling of DTS-ES input signals is determined automatically.) This setting is unavailable if no surround back speakers are connected.

You can select DTS+Neo:6 (default), Dolby EX, PLIIx Movie, PLIIx Music, or DTS.

- If only one surround back speaker is connected, PLIIx Movie is unavailable.

■ c. THX Mode (DTR-6.5 only)

This setting determines which surround mode is used when THX is used with DTS input signals. This setting is unavailable if no surround back speakers are connected.

You can select THX SurrEX, Neo:6+THX (default), PLIIx+THX, or THX Cinema.

- If only one surround back speaker is connected, PLIIx+THX is unavailable.

3-4. D.F. 2ch

These settings apply to digital input signals, Dolby Digital and so on, with only 2 channels (2/0).

■ a. Input Channel (Mono)

This setting determines which channel is output when the Mono listening mode is used with a stereo source.

L+R: Both the left and right channels are output (default).

Left: Only the left channel is output.

Right: Only the right channel is output.

■ b. Surround Mode

This setting determines the default surround mode for digital input signals, Dolby Digital and so on, with only 2 channels (2/0). This setting is unavailable if no center and surround speakers are connected.

You can select PLIIx Movie (default), PLIIx Music, PLIIx Game, Neo:6 Cinema, or Neo:6 Music.

If you're not using any surround back speakers, "PLIIx" will be "PLII."

If you're not using any surround speakers, Neo:6 Music cannot be selected.

3-5. Multiplex

This setting applies to multiplex input signals.

■ a. Input Channel

This setting determines which channel is output from a stereo multiplex source. Use it to select audio channels or languages with multiplex sources, multilanguage TV broadcasts, and so on.

Main: The main channel is output (default).

Sub: The sub channel is output.

Main/Sub: Both the main and sub channels are output.

3-6. Multichannel Input

These settings apply to the analog multichannel input.

■ a. Subwoofer Sensitivity

When using the DVD analog multichannel input, the loudness of the connected subwoofer also depends on the component that's connected to that input. If you find that it's too loud, set this to 0 dB, $+5$ dB, $+10$ dB, or $+15$ dB. The default setting is 0 dB.

■ b. SurrBack Mode (DTR-6.5 only)

If you're using surround back speakers, this setting determines which surround mode is used with analog multichannel input signals. This setting is unavailable if no surround back speakers are connected.

You can select Dolby EX, PLIIx Movie (default), PLIIx Music, or Multich (straight 5.1-channel playback).

- If only one surround back speaker is connected, PLIIx Movie is unavailable.

■ c. THX Mode (DTR-6.5 only)

This setting determines which surround mode is used when THX is used with analog multichannel input signals. This setting is unavailable if no surround back speakers are connected.





You can select THX SurrEX (default), PLIIx+THX, or THX Cinema.

- If only one surround back speaker is connected, PLIIx+THX is unavailable.

Advanced Setup—Continued

Audio Adjust Functions

Here you can set listening mode-related settings and functions.

<p>1</p> 	<p>Press the [Receiver] button followed by the [Setup] button. The main menu appears onscreen.</p>
<p>2</p> 	<p>Use the Up and Down [▲]/[▼] buttons to select "4. Audio Adjust," and then press [Enter]. The Audio Adjust menu appears.</p>
<p>3</p> 	<p>Use the Up and Down [▲]/[▼] buttons to select menu items, and then press [Enter].</p> <div data-bbox="443 1122 715 1368" style="border: 1px solid black; padding: 5px;"> <p>Menu</p> <hr/> <p>4. Audio Adjust</p> <hr/> <p>1. Mono 2. PLIIx/Neo:6 3. Enhance 4. Orchestra 5. Unplugged 6. Studio-Mix 7. TV Logic 8. Mono Movie 9. Theater-Dimensional</p> </div>
<p>4</p> 	<p>Use the Up and Down [▲]/[▼] buttons to select the settings, and use the Left and Right [◀]/[▶] buttons to set them. The settings are explained below.</p>
<p>5</p> 	<p>When you've finished, press the [Setup] button. The setup menu closes.</p>

Note:

- This procedure can also be performed on the AV receiver by using its [Setup] button, arrow buttons, and [Enter] button.

Advanced Setup—Continued

4-1. Mono

■ a. Output Channel

This setting determines which speakers are used to output mono audio when the Mono listening mode is used.

L/R: Mono audio is output from the front left and right speakers (default).

Center: Mono audio is output from the center speaker.

■ b. Academy (DTR-6.5 only)

Early movies had a mono soundtrack that suffered from audible hiss and a poor high-frequency response due to the quality of the film. To improve matters, the high-frequencies were boosted before being recorded onto film, and then attenuated to their original levels during playback in the movie theater. Some old movies have been transferred to newer distribution media without the high frequencies being attenuated, creating a harsh sound with pronounced hiss. With the Academy Filter, which is based on the playback techniques used in those days, you can attenuate those high-frequencies to their original levels and enjoy the movie as it was intended to be heard.

On: Academy Filter on.

Off: Academy Filter off (default).

4-2. PLIIx/Neo:6

If no surround back speakers are connected, this item will be “PLII/Neo:6” instead of “PLIIx/Neo:6.”

■ a. Panorama

With this function, you can broaden the width of the front stereo image when using the Dolby Pro Logic IIx Music listening mode.

On: Panorama function on.

Off: Panorama function off (default).

■ b. Dimension

With this setting, you can move the sound field forward or backward when using the Dolby Pro Logic IIx Music listening mode. The default setting is 3. Higher settings move the sound field forward. Lower settings move it backward.

If the stereo image feels too wide, or there's too much surround sound, move the sound field forward to improve the balance. Conversely, if the stereo image feels like it's in mono, or there's not enough surround sound, move it backward.

■ c. Center Width

With this function, you can adjust the width of the sound from the center speaker when using the Dolby Pro Logic IIx Music listening mode. If you're using a center speaker, with Dolby Pro Logic IIx, the center channel sound is output by only the center speaker. (If you're not using a center speaker, the center channel sound will be distributed to the front left and right speakers to create a phantom center). This setting controls the front left, right, and center mix, allowing you to adjust the weight

of the center channel sound. It can be adjusted from 0 to 7 (default is 3).

■ d. Center Image

The DTS Neo:6 Music listening mode creates 6-channel surround sound from 2-channel (stereo) sources. With this setting, you can specify by how much the front left and right channel output is attenuated in order to create the center channel. It can be adjusted from 0 to 5 (default is 3).

When set to 0, the front left and right channel output is attenuated by half (–6 dB), giving the impression that the sound is located centrally. This setting works well when the listening position is considerably off center. When set to 5, the front left and right channels are not attenuated, maintaining the original stereo balance.

4-3. Enhance, 4-4. Orchestra, 4-5. Unplugged, 4-6. Studio-Mix, 4-7. TV Logic & 4-8. Mono Movie

These settings apply to the Onkyo original DSP listening modes.

■ a. Front Effect

With this setting, you can turn off the reverb for the front speakers. This is useful when playing live material that already contains live reverberation and the reverb added by the DSP listening mode simply blurs the original sound. When the Front Effect is turned off, no reverb is added to the front left, right, and center speakers and the original reverberation can be heard as it is.

On: Front Effect on (default).

Off: Front Effect off.

■ b. Reverb Level

With this setting, you can adjust the amount of reverb to suit your listening environment, source material, and so on. The available settings are: Low, Middle (default), and High.

■ c. Reverb Time

With this setting, you can adjust the reverb time to suit your listening environment, source material, and so on. The available settings are: Short, Middle (default), and Long.

Advanced Setup—Continued

4-9. Theater-Dimensional

These settings apply to the Theater-Dimensional listening mode.

■ a. Listening Angle

With this setting, you can specify the angle of the front left and right speakers relative to the listening position. Processing for the Theater-Dimensional listening mode is based on this setting. Ideally, the front left and right speakers should be equidistant from the listening position and at an angle close to one of the two available settings.

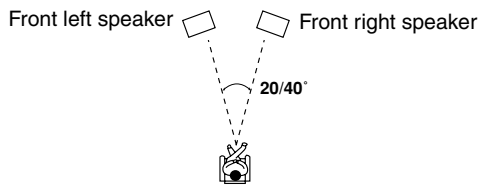

20°: Select if the listening angle is 20 degrees.

40°: Select if the listening angle is 40 degrees (default).

■ b. Center

With this setting, you can specify whether or not you're using a center speaker. If you are, the center channel sound will be output by the center speaker when using the Theater-Dimensional listening mode. This reduces the workload of the front left and right speakers, and creates a more articulate sound space. In this case, the settings for the distance between the listening position and each speaker, and the level of each speaker are important, but making these settings is a breeze with the Automatic Speaker Setup function (see page 39).

On: Select if using a center speaker.

Off: Select if not using a center speaker (default).

■ c. Front Expand

With the Front Expander function, you can broaden the width of the front stereo image. This can be useful with narrow listening angles of 20 degrees or less.

On: Front Expander function on.

Off: Front Expander function off (default).

■ d. Dialog Enhance

With this function, you can improve the clarity of the center channel, which usually contains dialog.

On: Dialog Enhance function on.

Off: Dialog Enhance function off (default).

■ e. Virtual Surr Level

With this setting, you can adjust the level of virtual surround sound from -3 dB to +3 dB (default is 0 dB). If the clarity is poor, or the effect sounds unnatural, you may be able to improve it by lowering this setting.

Assigning Listening Modes to Input Sources

You can assign a default listening mode to each input source that will be selected automatically when you select each input source. For example, you can set the default listening mode to be used with Dolby Digital input signals. You can select other listening modes during playback, but the mode specified here will be resumed once the AV receiver has been set to Standby.

1



Press the [Receiver] button followed by the [Setup] button.

The main menu appears onscreen.

2



Use the Up and Down [▲]/[▼] buttons to select "5. Listening Mode Preset," and then press [Enter].

The Listening Mode Preset menu appears.

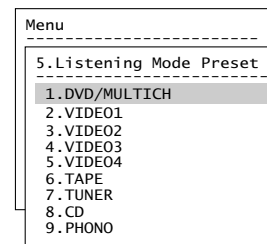

3



Use the Up and Down [▲]/[▼] buttons to select the input selector that you want to set, and then press [Enter].

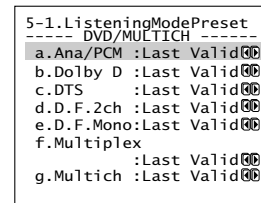

For input selectors that have no digital input jacks, only "a. Analog" will be available.

Advanced Setup—Continued

4



Use the Up and Down [▲]/[▼] buttons to select the signal format that you want to set, and then use the Left and Right [◀]/[▶] buttons to select a listening mode.

Only listening modes that can be used with each input signal format can be selected.

For “Surround” or “THX,” the listening mode specified on pages 66, 67 will be used.

The Last Valid option means that the listening mode selected last will be used.

a. Ana/PCM: With this setting, you can specify the listening mode to be used when an analog (CD, TV, LD, VHS, MD, turntable, radio, cassette, cable, satellite, etc) or PCM digital (CD, DVD, etc) audio signal is played.

b. Dolby D: With this setting, you can specify the listening mode to be used when a Dolby Digital format digital audio signal is played (DVD, etc).

c. DTS: With this setting, you can specify the listening mode to be used when a DTS format digital audio signal is played (DVD, LD, CD, etc).

d. D.F. 2ch: With this setting, you can specify the listening mode to be used when a 2-channel (2/0) digital audio signal (Dolby Digital, DTS) is played (DVD, etc).

e. D.F. Mono: With this setting, you can specify the listening mode to be used when a mono digital audio signal is played (DVD, etc).

f. Multiplex: With this setting, you can specify the listening mode to be used when a multiplex audio signal is played.

g. Multich: This setting is available only when “5-1. DVD/MULTCH” is selected. With this setting, you can specify the listening mode to be used when the DVD analog multichannel input is used.

5



When you’ve finished, press the [Setup] button.

The setup menu closes.

Note:

- This procedure can also be performed on the AV receiver by using its [Setup] button, arrow buttons, and [Enter] button.

Setting Preferences

This section explains the items on the Preference menu.

1



Press the [Receiver] button followed by the [Setup] button.

The main menu appears onscreen.

2



Use the Up and Down [▲]/[▼] buttons to select “6. Preference,” and then press [Enter].

The Preference menu appears.

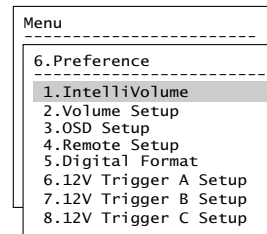

3



Use the Up and Down [▲]/[▼] buttons to select menu items, and then press [Enter].

4



Use the Up and Down [▲]/[▼] buttons to select the settings, and use the Left and Right [◀]/[▶] buttons to set them.

The settings are explained below.

5



When you’ve finished, press the [Setup] button.

The setup menu closes.

Note:

- This procedure can also be performed on the AV receiver by using its [Setup] button, arrow buttons, and [Enter] button.

Advanced Setup—Continued

6-1. IntelliVolume

With this preference, you can set the input level for each input source. This is useful if some of your AV components are louder or quieter than others.

While this preference is shown onscreen, you can select each input source and set the levels while listening to and comparing them.

If a component is too loud compared to your other components, use the Left [◀] button to adjust the level. If it's too quiet, use the Right [▶] button.

- The level can be set from -12 dB to +12 dB.

6-2. Volume Setup

■ a. Volume Display

With this preference, you can choose how the volume level is displayed.

Absolute: Display range is MIN, 1 through 99, MAX.

Relative: Display range is $-\infty$ dB, -81 dB, -80 dB through +18 dB.

The absolute value 82 is equivalent to the relative value 0 dB.

■ b. Maximum Volume

With this preference, you can prevent the volume being set too high by specifying a maximum volume level.

When the Volume Display preference is set to Absolute, the range is from 50 to 99. When it's set to Relative, the range is -32 dB through +17 dB. To specify no maximum volume, select Off.

■ c. Power On Volume

With this preference, you can specify the volume setting to be used each time the AV receiver is turned on.

When the a. Volume Display preference is set to Absolute, the range is MIN, 1 through 99, or MAX. When it's set to Relative, the range is $-\infty$ dB, -81 dB through +18 dB.

To use the same volume level that was used when the AV receiver was turned off, select Last.

The Power On Volume cannot be set higher than the maximum volume specified with the b. Maximum Volume setting.

■ d. Headphones Level

With this preference, you can specify the headphone volume relative to the main volume. This is useful if there's a volume difference between your speakers and your headphones. The headphone volume can be set between -12 dB and +12 dB.

6-3. OSD Setup

■ a. Immediate Display

This preference determines whether or not actions, such as selecting an input source, are displayed onscreen.

Normal: Actions displayed. Select this if you have a standard 4:3 TV.

Wide: Actions displayed. Select this if you have a widescreen 16:9 TV.

Off: Actions not displayed.

Even if this preference is set to Normal or Wide, actions are not displayed on the TV or projector that's connected to the COMPONENT VIDEO OUT.

■ b. Scan Mode

If the text in onscreen setup menus flickers due to compatibility with the connected display device (TV, projector, etc), set the Scan Mode to Non-Interlaced.

Interlaced: Default.

Non-Interlaced: Select if the text flickers.

- Depending on the display device, when Non-Interlaced is selected, the onscreen setup menus may not appear. If this happens, use the AV receiver's display and repeat the procedure to revert to Interlaced.

6-4. Remote Setup

■ a. Remote ID

With this setting, you can change the AV Receiver's remote control ID. You may need to change this if the remote controller's control codes overlap with those of another Integra component located in the same room.

- If you change the AV receiver's remote control ID, be sure to set the same ID on both the AV receiver and remote controller (see right column). The default ID for both is 1.

■ b. IR IN Position

When using a commercially available IR receiver, use this setting to specify its location.

Main: Select if the IR receiver is located in the main room.

Zone 2: Select if the IR receiver is located in, and will be used to control Zone 2.

Advanced Setup—Continued

6-5. Digital Format

■ b. Digital Format

This setting does not apply to input selectors not assigned to a digital input jack.

With this setting, you can set a digital input to DTS, PCM, or Auto. This can be set for each input selector individually.

Use the Up and Down [▲]/[▼] buttons to select the input selector that you want to set, and then use the Left and Right [◀]/[▶] buttons to select:

- Auto:** PCM, Dolby Digital, and DTS formats are accepted. If no digital signal is present, the analog input is used.
- DTS:** Select this option if playing a DTS CD with the Auto option produces noise while the AV receiver is identifying the DTS signal, or when using fast forward or fast reverse. Nothing is output if the input signal is not DTS.
- PCM:** Select this option if playing a CD or other PCM source with the Auto option causes the tops of tracks to be clipped. Nothing is output if the input signal is not PCM.

- If there is no digital connection, only Auto appears.
- Select Auto or DTS when playing a DTS CD or LD. If you select PCM, only noise will be heard.

6-6., 6-7., 6-8. 12V Trigger Setup

When the AV receiver's 12 V TRIGGER OUT A/B/C jack is connected to the 12 V TRIGGER IN jack on a connected component, you can specify whether or not a 12-volt trigger signal is output when that component is selected as the source for the main room, Zone 2, or both.

By default, on the Trigger A Setup menu, all input sources are set to Main. On the Trigger A and B Setup menus, all input sources are set to Off.

Off: No trigger signal is output.

Main: Select this if you want to output a 12-volt trigger signal when a connected component is selected as the source for the main room.

Zone2: Select this if you want to output a 12-volt trigger signal when a connected component is selected as the source for Zone 2.

Main/Zone2: Select this if you want to output a 12-volt trigger signal when a connected component is selected as the source for either the main room or Zone 2.

■ Delay

When several components are turned on simultaneously via the 12-volt triggers, depending on the type of components, a large amount of current may be drawn momentarily. To prevent this, you can delay the trigger signals output by the AV receiver. In addition, by delaying the trigger signal for your power amplifier so that it's the last

component to be turned on, you can avoid the "thump" noise that's sometimes heard when a source component is turned on.

The delay determines how long after the input source is changed on the AV receiver the trigger signal is output, and can be set to 0 sec, 1 sec, 2 sec, or 3 sec. When set to 0 sec, the trigger signal is output as soon as the input source is changed.

Changing the Remote Controller's ID

If several Integra components are used in the same room, the remote controller's control codes may overlap with those of another component. To differentiate the remote controller's control codes, you can change its ID to another number.

Notes:

If you change the remote controller's ID, be sure to set the same ID on both the remote controller and AV receiver (see 6-4. Remote Setup in the left column). The default ID for both is 1.

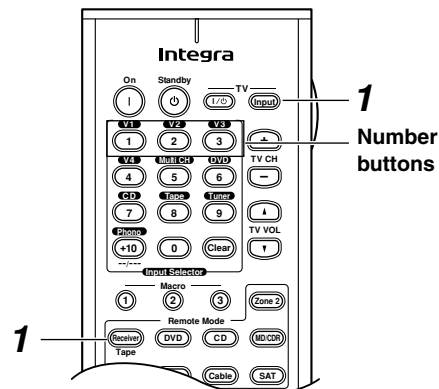

- 1** Press and hold down the [Receiver] button, and then press the TV [Input] button.
- 2** Use the number buttons to enter a remote control ID.
You can enter 1, 2, or 3.

Zone 2

Connecting Zone 2

With the Zone 2 function, you can enjoy one input source in the main room and a different source in another room.

There are two connection methods: using a receiver/integrated amp in Zone 2 or using only a pair of speakers in Zone 2.

Using a Receiver/Integrated Amp in Zone 2

With this connection method, you can use 7.1 surround sound in the main room and play a different AV source in Zone 2. The volume for Zone 2 is set on the receiver/integrated amp.

- Use an RCA audio cable to connect the AV receiver's ZONE 2 OUT L/R jacks to an analog audio input on your receiver/integrated amp.
- DTR-6.5 only: Connect the AV receiver's ZONE 2 OUT SUBWOOFER jack to the subwoofer in Zone 2.
- Connect the Zone 2 speakers to the speaker terminals on the receiver/integrated amp.

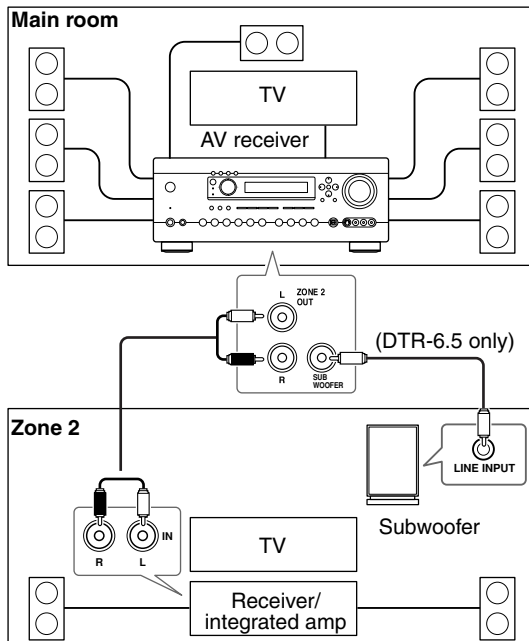

The AV receiver's ZONE 2 OUT jacks can also be used as pre outs, although, in this case, the volume cannot be controlled solely on the connected amplifier. See "Setting the Zone 2 Out" on page 76 for details.

Using Only Speakers in Zone 2

With this connection method, you can use 5.1 surround sound in the main room and play a different AV source in Zone 2. The volume for Zone 2 is set on the AV receiver.

- Set the Powered Zone 2 setting to Activated (see page 75).
- Connect your Zone 2 speakers to the AV receiver's ZONE 2 SPEAKERS terminals.

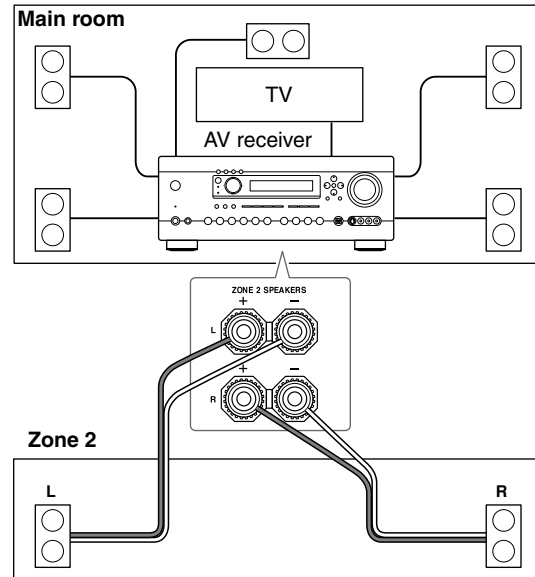

Zone 2—Continued

Setting the Powered Zone 2

To use Zone 2, you must make this setting. It enables the speakers connected to the ZONE 2 SPEAKERS terminals so that they produce sound when Zone 2 is used.

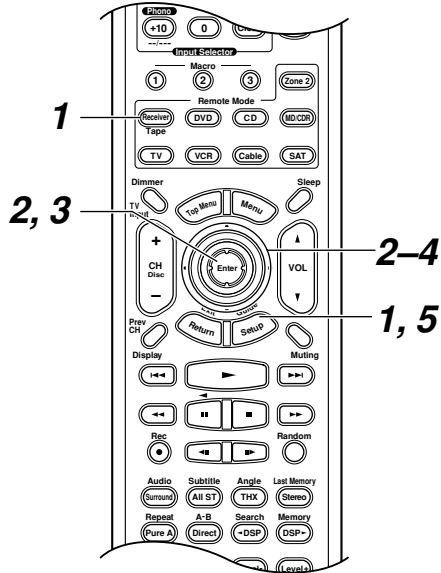

1 Press the [Receiver] button followed by the [Setup] button. The main menu appears onscreen.

2 Use the Up and Down [▲]/[▼] buttons to select "1. Initial Setup," and then press [Enter]. The Initial Setup menu appears.

3 Use the Up and Down [▲]/[▼] buttons to select "3. Hardware Setup," and then press [Enter]. The Hardware Setup menu appears.

4 Use the Up and Down [▲]/[▼] buttons to select "a. Powered Zone 2," and use the Left and Right [◀]/[▶] buttons to select:

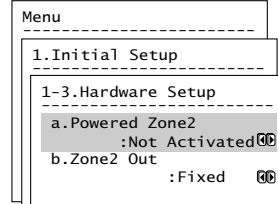

Not Activated: Zone 2 SPEAKERS terminals deactivated.

Activated: Zone 2 SPEAKERS terminals activated.

When Zone 2 is activated and turned on (see page 77), the speakers connected to the ZONE 2 SPEAKERS terminals output sound, but the speakers connected to the SURROUND BACK SPEAKERS terminals do not. (When Zone 2 is activated but not used, the surround back speakers work as normal.)

5 Press the [Setup] button. The setup menu closes.

Note:

- This procedure can also be performed on the AV receiver by using its [Setup] button, arrow buttons, and [Enter] button.

Zone 2—Continued

Setting the Zone 2 Out

The ZONE 2 OUT L/R jacks can also be used as pre outs.

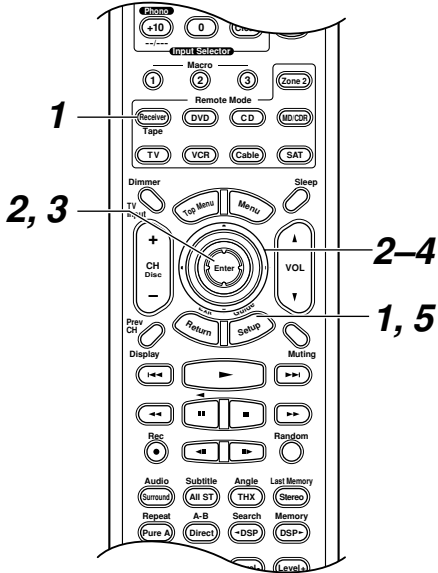

1

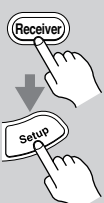

Press the [Receiver] button followed by the [Setup] button.
The main menu appears onscreen.

2



Use the Up and Down [▲]/[▼] buttons to select "1. Initial Setup," and then press [Enter].
The Initial Setup menu appears.

3

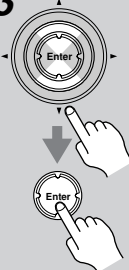

Use the Up and Down [▲]/[▼] buttons to select "3. Hardware Setup," and then press [Enter].
The Hardware Setup menu appears.

Menu

1. Initial Setup

1-3. Hardware Setup

a. Powered Zone2 :Not Activated **ⓐ**

b. Zone2 Out :Fixed **ⓐ**

4



Use the Up and Down [▲]/[▼] buttons to select "b. Zone 2 Out," and use the Left and Right [◀]/[▶] buttons to select:

Menu

1. Initial Setup

1-3. Hardware Setup

a. Powered Zone2 :Not Activated **ⓐ**

b. Zone2 Out :Fixed **ⓐ**

c. Sp Impedance Minimum :6ohms **ⓐ**

d. TV Format :AUTO **ⓐ**

Fixed: The ZONE 2 OUT L/R jacks work as line outs, and you can control the volume solely on the connected amplifier.
Variable: The ZONE 2 OUT L/R jacks work as pre outs. Since the output level is controlled by the AV receiver's Master Volume control, you cannot control the volume solely on the connected amplifier.

5



Press the [Setup] button.
The setup menu closes.

Zone 2—Continued

Using Zone 2

Here you can turn on Zone 2, select an input source, and adjust the volume.

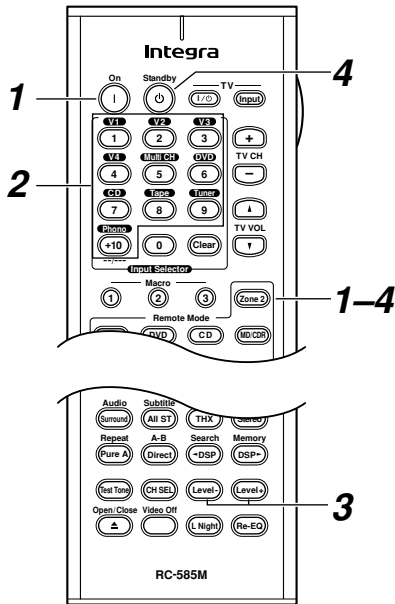

Note:

To control Zone 2 with the remote controller, you must press the [ZONE 2] button first.

1 **Point the remote controller at the AV receiver and press the [ZONE 2] button followed by the [On] button.**
This turns on Zone 2 and the AV receiver's 12V TRIGGER OUT.

2 **To select the Zone 2 input source with the remote controller, press the [ZONE 2] button followed by an input selector button.**
If you select AM or FM, you can use the remote controller's [TUNER] button to select the band.
To perform steps 1 and 2 on the AV receiver, press the [ZONE 2] button, and then use the Controller [◀]/[▶] buttons within five seconds.
The name of the selected Zone 2 source appears on the display.

3 **To adjust the Zone 2 volume with the remote controller, press the [ZONE 2] button, and then use the [Level-] and [Level+] buttons.**
To do this on the AV receiver, press the Zone 2 [Level] button, and then use the Controller [◀]/[▶] buttons.
If the Zone 2 receiver/integrated amp is connected to the AV receiver's ZONE 2 LINE OUT L/R jacks, use the volume control on the receiver/integrated amp.

4 **To turn off Zone 2 with the remote controller, press the [ZONE 2] button followed by the [Standby] button.**
To do this from the AV receiver, press the [ZONE 2] button, and then use the Controller [◀]/[▶] buttons to select OFF.

Notes:

- If the Sleep function has been set, the Zone 2 component will turn off along with the AV receiver when the specified sleep time expires. To use the Sleep function with Zone 2 only, set the Sleep function and then set the AV receiver to Standby.
- Only analog input sources are output by the ZONE 2 LINE OUT and ZONE 2 SPEAKERS terminals. Digital input sources are not output. If no sound is heard when an input source is selected, check if it's connected to an analog input.
- Since the Zone 2 function and the REC OUT outputs use the same circuitry, if the [Rec Out] function is used, Zone 2 will be turned off.
- While Zone 2 is being used, listening modes that need surround back speakers (i.e., Dolby Digital EX, DTS-ES, and THX Surround EX) are unavailable.
- While Zone 2 is on, **RI** functions will not work.
- You can't select different radio stations for Zone 2 and the main room. For example, if you an FM station for the main room, that station will also be used in Zone 2.

Zone 2—Continued



Using the 12V Trigger

When the AV receiver's 12 V TRIGGER OUT A/B/C jack is connected to the 12 V TRIGGER IN jack on a connected component, the AV receiver can be configured so that the component is turned on automatically when Zone 2 is used. See page 73 for details.

Adjusting the Bass & Treble for Zone2

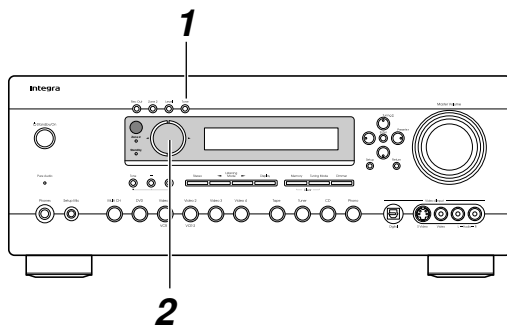
You can adjust the bass and treble for Zone2.



1	 <p>Press the [Tone] button repeatedly to select either Bass or Treble.</p>
2	 <p>Use the Controller [◀]/[▶] buttons to adjust.</p>

■ Bass

You can boost or cut low-frequency sounds output by the front speakers from -10 dB to +10 dB in 2 dB steps.

■ Treble

You can boost or cut high-frequency sounds output by the front speakers from -10 dB to +10 dB in 2 dB steps.

Using the Remote Control in Zone 2

To use the remote controller to control the AV receiver from Zone 2, you'll need one of the following commercially available multiroom remote control kits:

- Multiroom Kits such as those made by Niles and Xantech.

These kits can also be used when the AV receiver is not in line of sight of the remote controller, for example, when it's installed inside a cabinet.

Using a Multiroom Kit with Zone 2

In the following diagram, an IR receiver picks up the infrared signals from the remote controller in Zone 2 and feeds them to the AV receiver in the main room via the connecting block.

- On the Remote Setup menu, set the IR IN Position setting to "Zone 2" (see page 72).

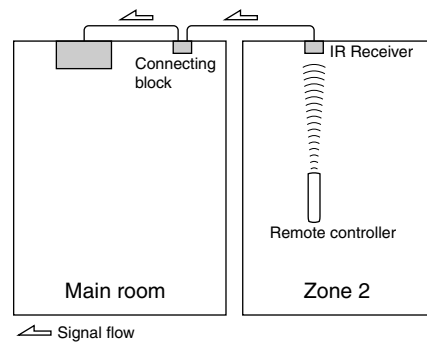

Connect the miniplug cable from the connecting block to the AV receiver's IR IN jack as shown below.

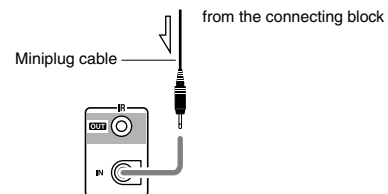

Zone 2—Continued

Using a Multiroom Kit with a Cabinet

In the following diagram, an IR receiver picks up the infrared signals from the remote controller and feeds them to the AV receiver in the cabinet via the connecting block.

- On the Remote Setup menu, set the IR IN Position setting to “Main” (see page 72).

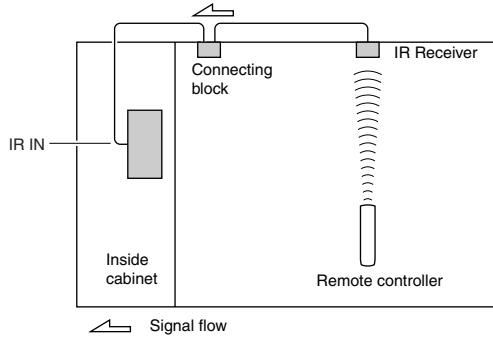

Controlling Out-of-range Components

If another AV component is out of range of its remote controller, you can use a commercially available IR emitter to retransmit the remote controller signals received at the AV receiver's IR IN, as shown below.

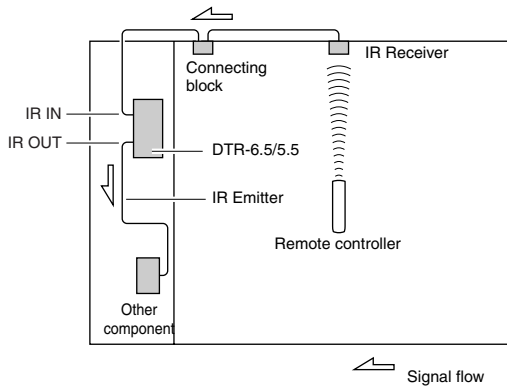

Connect the IR emitter to the AV receiver's IR OUT, and place the IR emitter in front of the other AV component's remote control sensor (usually located on the front panel), as shown below. See the instructions supplied with the IR emitter.

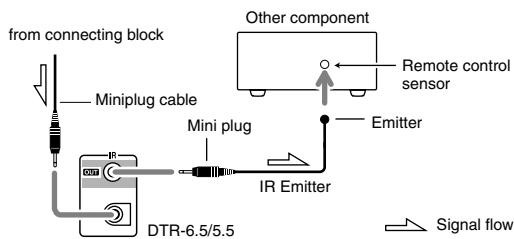

Only remote controller signals received by the AV receiver's IR IN are fed through to the IR OUT. Signals picked up by the AV receiver's remote control sensor are not output.

Controlling Other Components

You can use the AV Receiver's remote controller (RC-588M/RC-590M/RC-591M) to control your other components, including those made by other manufacturers. This chapter explains how to:

- Enter the remote control code for a component that you want to control (e.g., DVD, TV, VCR).
- Learn commands directly from another component's remote controller (see page 88).
- Program the Macro function to perform a sequence of actions with a single press of a button (see page 89).

Entering Remote Control Codes

Entering the appropriate remote control code for each Remote Mode button will allow you to control your other components with the remote controller. You'll need to perform this procedure for each component that you want to control.

For the [DVD], [TV], [VCR], [CABLE], and [SAT] buttons, choose a code from the respective category. For the [CD] and [MD/CDR] buttons, you can choose a code from any category. Remote control codes cannot be entered for the [Receiver] and [ZONE 2] buttons.

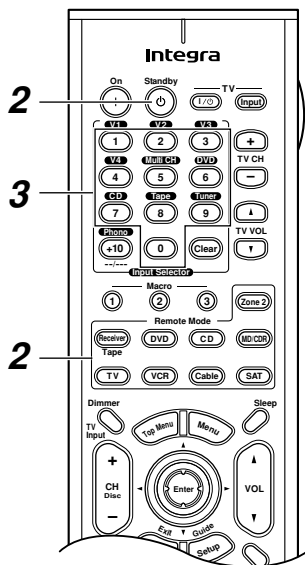

- 1** Look up the remote control code for your component. See "Remote Control Codes" on page 82.

- 2** While holding down the Remote Mode button that you want to enter the code for, press the [Standby] button.

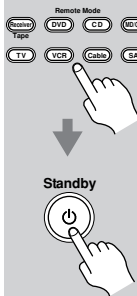

- 3** Within 30 seconds, use the number buttons to enter the 4-digit remote control code.

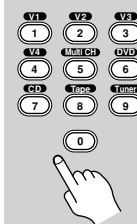

- 4** Select the remote controller mode, point the remote controller at the component, and check its operation.

Remote controller buttons that can be used in DVD mode are shown on page 16. Those that can be used with the TV, VCR, CABLE, and SAT modes are shown on pages 86, 87.

If the remote controller works OK, the code has been entered correctly. If not, try again or try another code.

Codes for Integra DVD Players

The remote control code for an Integra DVD player depends on whether it's connected via **RI**, as follows:

- 5001:** Use this code if you've connected an **RI** cable and an analog audio cable to your DVD player. This is the default setting, so if you're using **RI**, you don't need to change anything. Point the remote controller at the AV receiver to operate the DVD player.
- 5002:** Use this code if your DVD player doesn't have an **RI** jack, or you're not using **RI**. Point the remote controller at the DVD player to operate it.

Setting the [MD/CDR] Button to CDR

By default, the [MD/CDR] button is set to control a MiniDisc recorder. To control a CD recorder, it must be set to CDR. The codes are as follows:

- 6002:** Code for controlling a CD recorder.
- 6003:** Code for controlling an MD recorder (default).

Controlling Other Components—Continued

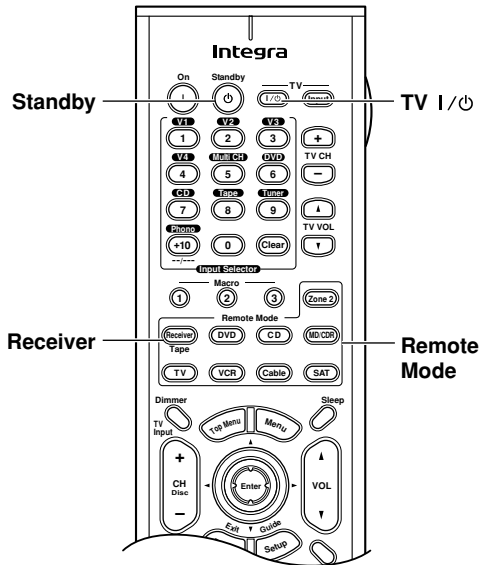

Resetting the Remote Controller

Here you can reset the remote controller to its default settings.

- 1**

While holding down the [Receiver] button, press the [Standby] button.
Release both buttons and wait five seconds.
- 2**

Press the [Receiver] button again.
The remote controller is reset.

Resetting Remote Mode Buttons

If you've entered another code for one of these buttons and now want to return to the default, perform the following procedure.

By default, some REMOTE MODE buttons are preprogrammed with remote control codes for controlling Integra components connected via **RI**.

- 1**

While holding down the Remote Mode button that you want to reset, press the TV [I/O] button.
Release both buttons and wait two seconds.
- 2**

Press the Remote Mode button again.
The Remote Mode button is reset.

Controlling Other Components—Continued

Remote Control Codes

When two or more codes are given, try each one in turn, and choose the one that works best.

Depending on the manufacturer and component, the remote controller may not work as expected.

DVD (DVD player)	
Manufacturer	Control code
Aiwa	5010
Akai	5019
Apex	5015, 5016
CyberHome	5027
Denon	5017, 5020
GE	5003
Hitachi	5009
Integra	5001, 5002
Integra Research	5001, 5002
JVC	5023
Kenwood	5017
Magnavox	5004, 5021
Marantz	5025, 5026
Mitsubishi	5005
Onkyo	5001, 5002
Panasonic	5011, 5017, 5020
Philips	5004, 5021, 5028
Pioneer	5006
Proscan	5003
RCA	5003
Sanyo	5012
Sony	5007, 5013, 5018, 5029
Technics	5020
Thomson	5022, 5024
Toshiba	5008, 5021
Xbox	5022
Yamaha	5020
Zenith	5014, 5021

SAT (satellite receiver)	
Manufacturer	Control code
Alba	4014, 4017, 4025, 4027
Allsat	4015, 4027
Alltech	4022, 4025
Amstrad	4013, 4019, 4025, 4030, 4031
Anglo	4025
Ankaro	4025
Antron	4017
Apollo	4017
Arcon	4016
Armstrong	4013
Asat	4016
Astra	4013, 4016, 4024
Astro	4019, 4020
AudioTon	4015
Bush	4012, 4014
Condor	4024

SAT (satellite receiver)	
Manufacturer	Control code
Conrad	4024
Cosat	4015, 4023
Crown	4013
Daewoo	4016, 4017, 4025
Diamond	4022
Dishnet	4008
Dual	4016
Echostar	4010, 4018, 4025
Einhell	4013, 4017, 4025
Elta	4015, 4017
Engel	4025
Eurosat	4013, 4022
Eurosky	4013, 4024
Eurostar	4024
Fagor	4015, 4023
Ferguson	4012
Fidelity	4030
Fracarro	4017
FTE	4025, 4030
Fuba	4017
Galaxis	4015, 4023
GE	4001, 4002
General Instruments	4003
GMI	4013
Grundig	4021, 4029, 4031
Hinari	4017
Hirschmann	4019, 4035
Hitachi	4036, 4037
Hughes Network Systems	4011
Huth	4013, 4015, 4024
Imperial	4014
Intertronic	4013
Intervision	4015, 4023, 4024
Johansson	4015
JVC	4009, 4021
Kathrein	4025
Kolon	4017
K-SAT	4025
Kyostar	4017
Lasat	4013, 4020, 4024
Lenco	4016, 4017, 4025
Lennox	4023
Loewe	4013
Lorenzen	4024
Macab	4022
Manhattan	4015, 4020, 4023
Maspro	4021, 4025
Matsui	4021
Mediamarkt	4013
Medion	4025
Metronic	4013, 4017, 4020
Micro Technology	4025
Minerva	4021
Morgan's	4013, 4015, 4025
Mysat	4025
Neuhaus	4019, 4023, 4024, 4025
Neusat	4025

SAT (satellite receiver)	
Manufacturer	Control code
Nikko	4013, 4025, 4027
Nokia	4033
Nordmende	4017, 4020
Oceanic	4022
Octagon	4016, 4017
Okano	4013
Optex	4015, 4023
Orbit	4016
Orbitech	4017, 4019
Pace	4012, 4026, 4031
Pacific	4022
Palladium	4013, 4017, 4021
Palsat	4019
Panasonic	4006, 4031
Panda	4024
Philips	4021, 4029
Phonotrend	4015, 4023
Predki	4017
Premier	4023
Primestar	4007
Proscan	4001, 4002
Protek	4022
Pye	4021
Quelle	4024
Radix	4035
RCA	4001, 4002
Roadster	4025
Rover	4025
Saba	4014, 4020, 4024, 4027
Samsung	4017
Satcom	4024
SatPartner	4017, 4020, 4027, 4030
Schneider	4029
Sedea Electronique	4017
Seemann	4013
SEG	4017, 4028
Seleco	4015, 4023
Skymaster	4025, 4034
Skyvision	4015
Sony	4005, 4031
Strong	4016, 4017, 4020
Sunstar	4013
Techniland	4015, 4023
TechniSat	4019
Teco	4013, 4016
Teleciel	4027
Telefunken	4017
Teleka	4013
Telemaster	4020
Telewire	4015, 4023
Tensai	4016
Thomson	4024, 4025
Thorens	4022
Tonna	4015, 4023, 4025
Toshiba	4004
Triasat	4019

Controlling Other Components—Continued

SAT (satellite receiver)	
Manufacturer	Control code
Tristar	4016
Unisat	4013
Universum	4021, 4024
Vortec	4017
Wela	4025
Zehnder	4020
Zenith	4032

CBL (cable receiver)	
Manufacturer	Control code
ABC	3001, 3002, 3021
Archer	3006
Cabletime	3028, 3032
Cableview	3004
Contec	3009
Eastern	3010
GE	3001, 3002
Gemini	3011
General Instruments	3002, 3022
Grundig	3031
Hamlin	3012
Hitachi	3002
Jerrold	3002, 3011, 3013, 3021, 3022, 3023, 3026
Magnavox	3014
Memorex	3015
Movie Time	3016
NEC	3003
Nokia	3033
NSC	3016
Oak	3009
Panasonic	3020
Philips	3007, 3008, 3014
Pioneer	3017, 3024
Proscan	3001, 3002
RCA	3004, 3020, 3022
Realistic	3006
Sagem	3034
Salora	3029
Samsung	3017
Signature	3002
Sprucer	3020
Standard Component	3018
Starcom	3011, 3021
Stargate	3011
Tele+1	3030
Tocom	3013
United Cable	3021, 3023
Universal	3005, 3006
Videoway	3025
View Star	3009, 3014, 3016
Zenith	3019

VCR	
Manufacturer	Control code
Aiwa	2012, 2046, 2047
Akai	2003, 2004, 2022
Alba	2033, 2041, 2044, 2045, 2047
Anitech	2033
ASA	2034
Baird	2036
Bell & Howell	2007
Blaupunkt	2039, 2042
Bush	2033, 2041, 2044, 2045, 2047
Canon	2010, 2011
Carver	2014
Cimline	2033
Citizen	2008, 2009
Colortyme	2005
Craig	2008
Crown	2033
Curtis Mathes	2001, 2005, 2008, 2009, 2010, 2011, 2023, 2026
Cyrus	2034
Daewoo	2012
Dansai	2033
Decca	2034
Dimensia	2001, 2026
Dumont	2034, 2036, 2037
Elcotech	2033
Emerson	2003, 2010, 2012, 2022
ESC	2043
Ferguson	2035
Finlandia	2034, 2036
Finlux	2034, 2036, 2037
Firstline	2033, 2041
Fisher	2007, 2030, 2036
Fuji	2004, 2010, 2024
Funai	2012
Garrard	2012
GE	2001, 2002, 2008, 2010, 2011, 2023, 2025, 2026
GEC	2034
GoldHand	2033
GoldStar	2005, 2009
Goodmans	2031, 2033
Gradiente	2012
Graetz	2036, 2043
Granada	2030, 2034, 2036
Grandin	2033
Grundig	2029, 2033, 2034, 2039, 2040, 2042, 2044
Harman Kardon	2005
HCM	2033, 2044
Hinari	2028, 2033, 2043, 2044, 2047
Hitachi	2013, 2021, 2025, 2028, 2037, 2038, 2043
Ingersol	2028
Interfunk	2034
ITT	2030, 2036, 2043, 2048
JC Penney	2005, 2006, 2007, 2008, 2010, 2011, 2013, 2014, 2021

VCR	
Manufacturer	Control code
Jensen	2013
JVC	2005, 2006, 2007, 2009, 2032, 2035, 2040, 2048
Kaisui	2033
Kendo	2041, 2046
Kenwood	2005, 2006, 2007, 2009
Kodak	2010
Loewe	2028, 2034
Logik	2028, 2043
Luxor	2030, 2031, 2036
Magnavox	2010, 2011, 2014, 2019, 2020
Marantz	2005, 2006, 2007, 2009, 2010, 2014, 2031, 2034
Matsui	2028, 2041, 2046, 2047
Matsushita	2010
Memorex	2007, 2008, 2010, 2012, 2019, 2030, 2036
Metz	2039
MGA	2022
Minerva	2039
Minolta	2013, 2021
Mitsubishi	2013, 2022, 2032, 2034
Motorola	2010
MTC	2008
Multitech	2008, 2012, 2033
NEC	2005, 2006, 2007, 2009, 2032
Neckermann	2034
Nesco	2033
NOBLEX	2008
Nokia	2030, 2036, 2043
Nordmende	2048
Okano	2046
Olympus	2010
Optonica	2017
Orion	2028, 2041, 2045, 2046, 2047
Osaki	2033
Otto Versand	2034
Palladium	2033
Panasonic	2010, 2011, 2042
Pentax	2013, 2021, 2025, 2037
Pentex Research	2009
Philco	2010, 2011, 2014
Philips	2010, 2014, 2017, 2034, 2048
Phonola	2034
Pioneer	2006, 2013, 2032, 2034
Proline	2044
Proscan	2001, 2002, 2026
Pye	2034
Quasar	2010, 2011
Quelle	2034
Radio Shack	2017
Radio Shack/ Realistic	2007, 2008, 2010, 2011, 2012, 2017
Radiola	2034

Controlling Other Components—Continued

VCR	
Manufacturer	Control code
RCA	2001, 2002, 2003, 2008, 2010, 2013, 2021, 2023, 2025, 2026, 2027
Realistic	2007, 2008, 2010, 2011, 2012, 2017
Rex	2048
Roadstar	2033, 2043
Runco	2019
Saba	2040, 2048
Saisho	2028, 2041
Salora	2030
Samsung	2008, 2043, 2049
Sansui	2006, 2032
Sanyo	2007, 2008, 2030, 2036
Saville	2047
SBR	2034
Schaub Lorenz	2036
Schneider	2033, 2034
Scott	2015
Sears	2007, 2010, 2013, 2021
SEG	2043
SEI	2028, 2034
Sharp	2016, 2017, 2031
Shintom	2004, 2033, 2036
Shorai	2028
Siemens	2034, 2036, 2039
Singer	2010
Sinudyne	2028, 2034
Sonorol	2030, 2031
Sony	2004, 2018, 2024
STS	2010, 2021
Sunkai	2046
Sylvania	2010, 2011, 2012, 2014
Symphonic	2012
Tandy	2007
Tatung	2034
Teac	2012
Technics	2010, 2042
Teknika	2010, 2012
Telefunken	2048
Thomson	2048
Thorn	2035, 2036
Toshiba	2013, 2015, 2022, 2034, 2048
Totevision	2008
Uher	2043
Unitech	2008
Universum	2034, 2039, 2043
Vector Research	2005, 2006
Video Concepts	2005, 2006, 2022
Wards	2008, 2010, 2012, 2013, 2017, 2021, 2027
XR-1000	2010, 2012
Yamaha	2005, 2006, 2007, 2009
Yoko	2043
Zenith	2004, 2019, 2024

TV	
Manufacturer	Control code
Admiral	1026, 1040, 1062
Akai	1002, 1067
Akura	1045
Alba	1035, 1043
Amplivision	1063
Amstrad	1035, 1067
Amtron	1009
Anam National	1003, 1009
Anitech	1035
AOC	1004, 1005, 1006
Arc en Ciel	1066
Arcam	1063
ASA	1040
Audiovox	1009
Autovox	1040, 1068
Baird	1069
Bang & Olufsen	1040
Baur	1036, 1054, 1055, 1058, 1059, 1068
Beko	1052
Bell & Howell	1010, 1017
Binatone	1063
Blaupunkt	1041, 1042, 1044, 1058, 1059
Boots	1063
Brionvega	1040
Bruns	1040
BSR	1048
Bush	1035, 1043, 1048, 1050, 1053, 1057
Cascade	1035
Celebrity	1002
Century	1040
Cimline	1035, 1043
Citizen	1004, 1006, 1009, 1017, 1022, 1025
Clatronic	1052
Colortyme	1004, 1006
Condor	1052
Contec	1035
Contec/Cony	1007, 1009
Continental Edison	1066
Craig	1009
Crosley	1040
Crown	1009, 1014, 1035, 1052
Curtis Mathes	1001, 1004, 1006, 1010, 1017, 1022, 1025, 1034
Daewoo	1004, 1005, 1006, 1025, 1035, 1053
Daytron	1004, 1006, 1025, 1035
Decca	1067
Dimensia	1001, 1034
Dixi	1035
Dual	1057, 1068
Dumont	1004, 1039, 1040
Electroband	1002
Electrohome	1002, 1003, 1004, 1006, 1008
Elta	1035

TV	
Manufacturer	Control code
Emerson	1004, 1006, 1007, 1009, 1010, 1017, 1025, 1027, 1029, 1033, 1040, 1070
Envision	1004, 1006
Erres	1037
Europhon	1067
Fidelity	1068
Finlux	1039, 1040, 1067
Firstline	1035, 1043, 1048, 1049, 1063
Fisher	1010, 1017, 1052, 1063, 1068
Formenti	1040
Frontech	1045, 1062
Fujitsu	1070
Funai	1009, 1045, 1048, 1070
GE	1001, 1003, 1004, 1006, 1011, 1012, 1019, 1034
GEC	1038, 1063, 1067, 1069
Geloso	1035
Genexxa	1062
GoldStar	1004, 1005, 1006, 1007, 1008, 1025, 1047, 1063
Goodmans	1043, 1053, 1063
Gorenje	1052
Graetz	1062, 1069
Granada	1063, 1067
Grundig	1039, 1041, 1042, 1058, 1059, 1064
Hallmark	1004, 1006
Hanseatic	1060, 1068
Hantarex	1067
HCM	1035
Hinari	1035, 1043
Hitachi	1004, 1006, 1007, 1013, 1027, 1038, 1062, 1063, 1069
Huanyu	1053
ICE	1045, 1063
Imperial	1052
Infinity	1014
Inno Hit	1056, 1067
Interfunk	1055, 1062, 1066, 1069
Intervision	1045, 1063
ITT	1062, 1068, 1069
JBL	1014
JC Penney	1001, 1004, 1005, 1006, 1011, 1012, 1016, 1019, 1022, 1025, 1034
Jensen	1004, 1006
JVC	1007, 1012, 1013, 1015, 1033
Kaisui	1035, 1063
Kapsch	1062, 1069
Kathrein	1060
Kawasho	1002, 1004, 1006
Kendo	1043
Kenwood	1004, 1006, 1008
Kloss Novabeam	1009
Korting	1040
KTV	1009, 1025
LG	1005

Controlling Other Components—Continued

TV	
Manufacturer	Control code
Loewe	1014, 1040, 1055
Luxman	1004, 1006
LXI	1001, 1006, 1010, 1014, 1016, 1017, 1034
M Electronic	1035, 1053, 1062, 1063
Magnadyne	1040, 1067, 1068
Magnafon	1067
Magnavox	1004, 1006, 1008, 1014, 1018, 1020
Marantz	1004, 1006, 1014, 1060
Matsui	1035, 1043, 1048, 1050, 1063, 1064, 1067, 1068
Megatron	1006
Memorex	1005, 1006, 1010, 1017, 1035
Metz	1040, 1051, 1058
MGA	1004, 1005, 1006, 1008
Minerva	1039, 1058, 1059, 1064
Mitsubishi	1004, 1005, 1006, 1008, 1040, 1055, 1058
Mivar	1047, 1056, 1067
Motorola	1003, 1026
MTC	1004, 1005, 1006, 1022, 1055
Multitech	1009, 1035
NAD	1006, 1016
NEC	1003, 1004, 1005, 1006
Neckermann	1040, 1041, 1054, 1059, 1060
Nikkai	1045
Nikko	1006
Oceanic	1062
Onwa	1009
Optonica	1021, 1026
Orion	1029, 1043, 1048, 1049, 1050, 1067, 1068
Osaki	1045, 1063
Otto Versand	1036, 1041, 1043, 1054, 1055, 1058, 1059, 1060, 1063
Palladium	1052
Panasonic	1003, 1012, 1014, 1031, 1044, 1046, 1051, 1061, 1062, 1069
Pathe Marconi	1066
Philco	1003, 1004, 1005, 1006, 1007, 1008, 1014, 1018, 1040
Philips	1003, 1004, 1007, 1008, 1014, 1018, 1019, 1020, 1037, 1038, 1040, 1053, 1059, 1060
Phoenix	1040
Phonola	1037, 1040
Pioneer	1004, 1006, 1027, 1062
Portland	1004, 1005, 1006, 1025
Price Club	1022
Prism	1012
Profex	1035
Proline	1049
Proscan	1001, 1034
Protech	1035, 1045, 1063
Proton	1004, 1006, 1007
Pye	1037

TV	
Manufacturer	Control code
Quasar	1003, 1012, 1031
Quelle	1036, 1039, 1054, 1055, 1058, 1059, 1068
Radio Shack	1010, 1017, 1034
Radio Shack/ Realistic	1001, 1004, 1006, 1007, 1009, 1010, 1017, 1021, 1025
Radiola	1037
Radiomarelli	1040, 1067
RCA	1001, 1003, 1004, 1005, 1006, 1008, 1027, 1034
Realistic	1010, 1017, 1034
Rex	1045, 1062
RFT	1040
Roadstar	1035, 1045
Saba	1040, 1062, 1066, 1069
Saisho	1035, 1043, 1045, 1067, 1068
Salora	1062
Sambers	1056, 1067
Sampo	1004, 1006, 1025
Samsung	1004, 1005, 1006, 1007, 1008, 1022, 1025, 1035, 1045, 1047, 1052, 1056, 1060, 1063, 1065
Sansui	1029
Sanyo	1004, 1010, 1017
SBR	1037, 1038
Schaub Lorenz	1069
Schneider	1068
Scott	1004, 1006, 1007, 1009, 1070
Sears	1001, 1004, 1006, 1008, 1010, 1015, 1016, 1017, 1028, 1034, 1070
SEG	1045, 1063
SEI	1036, 1040, 1048, 1067, 1068
Seleco	1062
Sharp	1004, 1006, 1007, 1021, 1023, 1025, 1026
Shorai	1048
Siarem	1040, 1067
Siemens	1041, 1042, 1058, 1059
Singer	1040
Sinudyne	1036, 1040, 1043, 1067, 1068
Solavox	1062
Sonoko	1035
Sonolor	1062
Sony	1002, 1030, 1032, 1036, 1054
Soundesign	1004, 1006, 1009, 1070
Starlite	1009
Stern	1062
Sunkai	1043, 1048, 1049, 1050
Sylvania	1004, 1006, 1008, 1014, 1018, 1020
Symphonic	1009, 1028
Tandy	1026, 1062, 1063
Tashiko	1038, 1063
Tatung	1003, 1063, 1067
Tec	1063

TV	
Manufacturer	Control code
Technics	1012, 1044, 1061
Techwood	1004, 1006, 1012
Teknika	1004, 1005, 1006, 1007, 1009, 1022, 1025, 1031, 1070
Teleavia	1066
Telecaption	1024
Telefunken	1066
Teletech	1035
Teleton	1063
Tensai	1048
Thomson	1066
Thorn	1054, 1055, 1058
Toshiba	1010, 1016, 1017, 1022, 1024, 1039
Totevision	1025
Triumph	1067
Universal	1011, 1019
Universum	1045, 1052, 1058
Voxson	1040, 1062
Waltham	1063
Wards	1001, 1004, 1005, 1006, 1008, 1011, 1014, 1018, 1019, 1020, 1021, 1034, 1070
Watt Radio	1068
Wega	1040
Yamaha	1004, 1005, 1006, 1008
Yoko	1045, 1063
Zenith	1004

Controlling Other Components—Continued

To control another component, point the remote controller at it and use the buttons as explained below (you must select the appropriate remote control mode first).

Controlling a TV

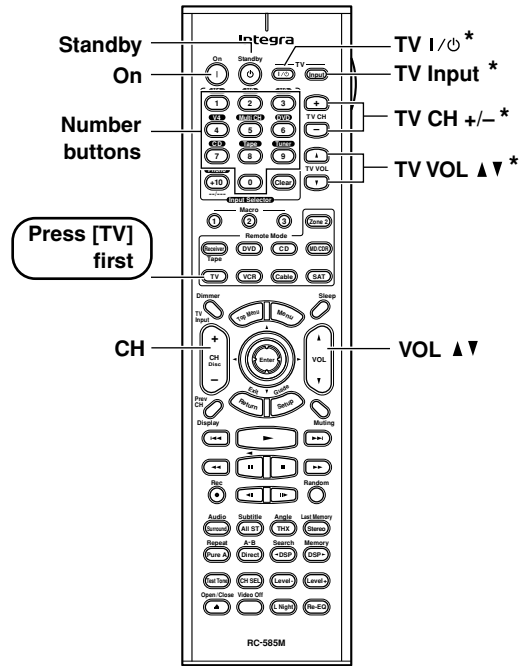

[On], [Standby]	Set the TV to On or Standby
TV [I/Power]	Turn the TV on or off
Number buttons	Enter numbers
[CH +/-]	Select channels on the TV
[TV INPUT]	Select inputs on the TV
VOL [▲]/[▼]	Adjust the TV's volume

* Buttons marked with an asterisk can always be used to control a TV regardless of the currently selected remote controller mode.

The following buttons control the AV Receiver.

[VOL]: Adjusts the volume of the AV receiver.

[Muting]: Mutes the AV Receiver.

Controlling a Cable Receiver

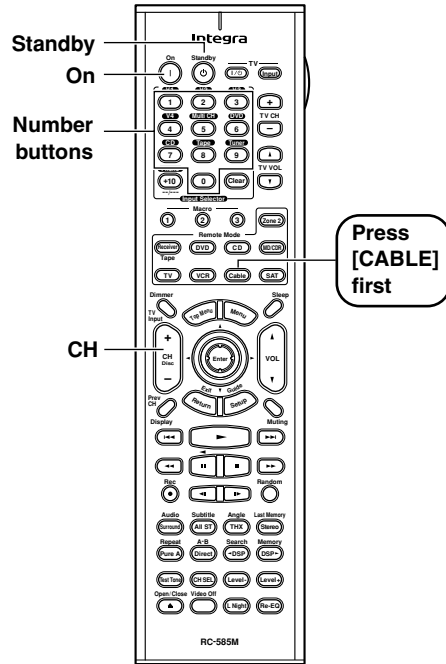

[On], [Standby]	Set the cable receiver to On or Standby
[CH +/-]	Select cable channels
Number buttons	Enter numbers

The following buttons control the AV Receiver.

[VOL]: Adjusts the volume of the AV receiver.

[Muting]: Mutes the AV Receiver.

Controlling Other Components—Continued

Controlling a VCR

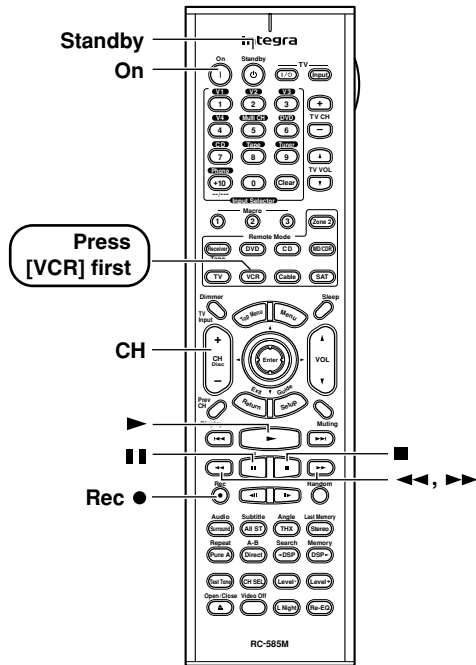

[On], [Standby]	Set the VCR to On or Standby
[CH +/-]	Selects channels on the VCR
[▶]	Play
[■]	Stop
[◀◀]	Rewind
[▶▶]	Fast forward
[⏸]	Pause
REC [●]	Record

The following buttons control the AV Receiver.
[VOL]: Adjusts the volume of the AV receiver.
[Muting]: Mutes the AV Receiver.

Controlling a Satellite Receiver

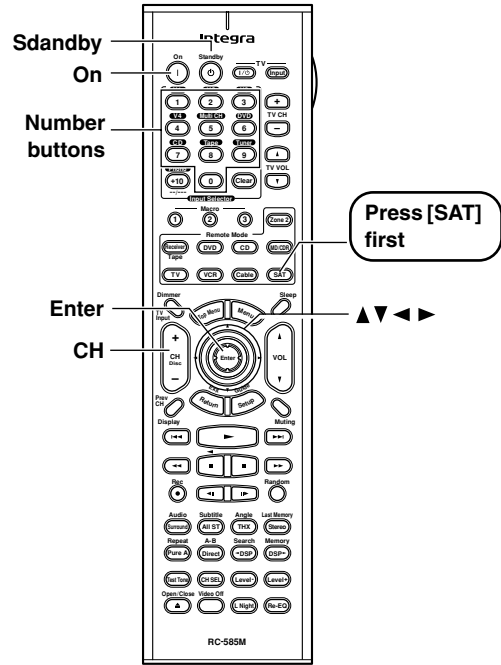

[On], [Standby]	Set the satellite receiver to On or Standby
[CH +/-]	Select satellite channels
[▲]/[▼]/[◀]/[▶]	Select menu items
[Enter]	Confirm selection
Number buttons	Enter numbers

The following buttons control the AV Receiver.
[VOL]: Adjusts the volume of the AV receiver.
[Muting]: Mutes the AV Receiver.

Controlling Other Components—Continued

Learning Commands from Another Remote Controller

The AV receiver's remote controller can learn the commands of other remote controllers simply by pointing them at each other. For example, by transmitting the Play command from your CD player's remote controller, the remote controller can learn it and then transmit the same command when its Play [▶] button is pressed in CD mode.

This is convenient when you want to add commands to buttons after entering a remote control code (page 80).

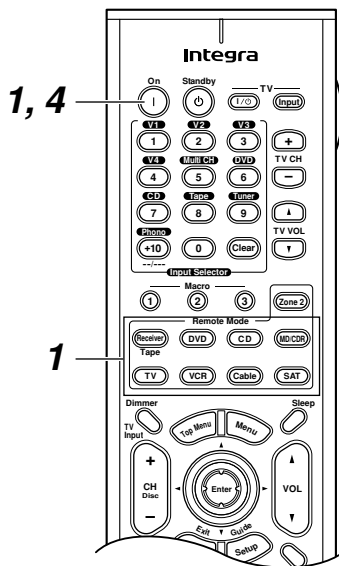

1 While holding down the Remote Mode button that you want to learn the command, press the [On] button.

2 On the AV receiver's remote controller, press the button you want to learn the new command.

3

Point the remote controllers at each other, about 2 to 6 inches (5–15 cm) apart, and then, on the other remote controller, press the button whose command you want to learn.

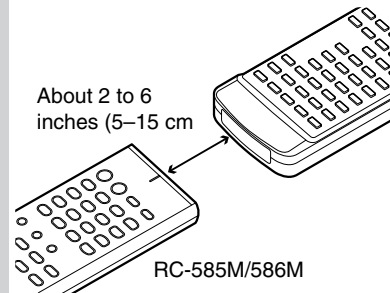

4

To teach the AV receiver's remote controller more new commands, repeat steps 2 and 3.

Press the [On] button when you've finished.

Notes:

- The following buttons cannot be taught new commands: Remote Mode, Macro [1], [2], [3], TV [I/⏻], TV [Input], TV CH [+]/[-], TV VOL [▲]/[▼].
- The AV receiver's remote controller can learn up to approximately 150 commands. However, the commands of some remote controllers may use a lot of memory, in which case, this will be reduced.
- By default, the AV receiver's remote controller knows the commands for controlling an Integra CD player, cassette deck, DVD player, and MD player (e.g., Play, Stop, Pause, etc., buttons). These buttons can learn new commands, although the defaults will be restored if the remote controller is reset.
- To learn a new command for a button that has already learned one, simply repeat this procedure.
- Like most remote controllers, the AV receiver's remote controller uses infrared. Commands from remote controllers that don't use infrared cannot be learnt.
- When the remote controller's batteries expire, all learned commands will be lost and will have to be learned all over again, so don't discard your other remote controllers.

Controlling Other Components—Continued

Using Macros

With the Macro function, you can program the remote controller's Macro buttons to perform a sequence of actions with just one button press. For example, normally you need to perform the following actions to play a CD:

1. Press the Remote Mode [Receiver] button to select Receiver mode.
2. Press the [On] button to turn on the AV receiver.
3. Press the [CD] Input Selector button to select the CD input source.
4. Press the Remote Mode [CD] button to select the CD remote controller mode.
5. Press the Play [▶] button to start playback on the CD player.

With the Macro function, you can program one of the Macro buttons to perform all five actions in one go.

Making Macros

There are three Macro buttons, and each button can be programmed with a different macro in each remote controller mode. Each macro can perform up to eight actions.

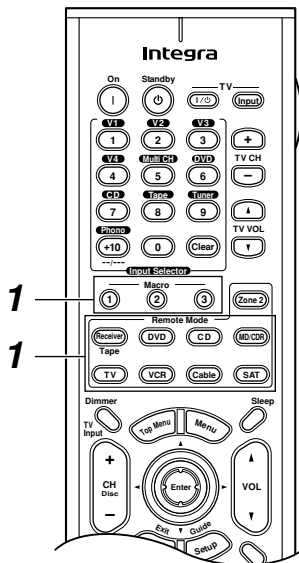

1

While holding down the Remote Mode button for the mode that you want to learn the macro, press Macro button [1], [2], or [3]. The Remote indicator lights up.

The diagram illustrates the first step of macro programming. A hand is shown pressing the 'Receiver' button in the Remote Mode section. Below this, another hand is shown pressing one of the three Macro buttons (labeled 1, 2, or 3). The text indicates that the Remote indicator will light up during this process.

2

On the remote controller, press the buttons whose actions you want to program into the macro in the order you want them performed.

For example, to program the previous CD example into a macro, press the following buttons: Remote Mode [Receiver], [On], Input Selector [CD], Remote Mode [CD], Play [▶].

3

When you've finished, press the Macro button again.

Notes:

- If after programming a macro you teach one of the buttons in that macro a new command, then the macro will no longer work properly. In this case, you must program the macro again.

Running Macros

Programmed macros can be run as follows.

1

Press the Macro [1], [2], or [3] button.

The actions in the macro are performed in the order in which they were programmed.

Troubleshooting

If you have any trouble using the AV receiver, look for a solution in this section. If you can't resolve the issue yourself, contact the dealer from whom you purchased this unit.

Power

Can't turn on the AV receiver?

- Make sure that the power cord is properly plugged into the wall outlet.
- Unplug the power cord from the wall outlet, wait five seconds or more, then plug it in again.

The AV receiver turns off as soon as it's turned on?

- The amp protection circuit has been activated. Remove the power cord from the wall outlet immediately and contact the dealer from whom you purchased this unit.

Audio

There's no sound, or it's very quiet?

- Make sure that all audio connecting plugs are pushed in all the way (page 21).
- Make sure that the inputs and outputs of all components are connected properly (page 21).
- Make sure that the polarity of the speaker cables is correct, and that the bare wires are in contact with metal part of each speaker terminal (page 23)
- Make sure that the input source is properly selected (page 53).
- Make sure that the speaker cables are not shorting.
- Check the volume. It can be set to MIN, 1 through 99, or MAX (page 53). The AV receiver is designed for home theater enjoyment. It has a wide volume range, allowing precise adjustment.
- If the MUTING indicator is shown on the display, press the remote controller's [Muting] button to unmute the AV receiver (page 54).
- While a pair of headphones is connected to the Phones jack, no sound is output by the speakers (page 54).
- Check the digital audio output setting on the connected device. On some games consoles, such as those that support DVD, the default setting is off.
- With some DVD-Video discs, you need to select an audio output format from a menu.
- For the DTR-5.5, if your turntable doesn't have a built-in phono preamp, you must connect one between it and the AV receiver. If your turntable uses an MC cartridge, you must connect an MC head amp, or an MC transformer and phono equalizer.
- For the DTR-6.5, if your turntable uses an MC cartridge, you must connect an MC head amp or an MC transformer (see page 36).

- Make sure that none of the connecting cables are bent, twisted, or damaged.
- Not all listening modes use all speakers (page 60).
- Specify the speaker distances (page 48) and adjust the individual speaker levels (page 50).
- Make sure that the speaker setup microphone is not still connected.

Only the front speakers produce sound?

- When the Stereo listening mode is selected, only the front speakers and subwoofer produce sound.
- When the Direct or Pure Audio listening mode is selected, only the front speakers produce sound.
- Make sure the speakers are configured correctly (page 46).

Only the center speaker produces sound?

- If you use the Pro Logic IIx Movie or Pro Logic IIx Music listening mode with a mono source, such as an AM radio station or mono TV program, the sound is concentrated in the center speaker.
- Make sure the speakers are configured correctly (page 46).

The surround speakers produce no sound?

- When the Stereo, Direct, or Pure Audio listening mode is selected, the surround speakers produce no sound (page 60).
- Depending on the source and current listening mode, not much sound may be produced by the surround speakers. Try selecting another listening mode.
- Make sure the speakers are configured correctly (page 46).

The center speaker produces no sound?

- When the Mono, Stereo, Direct, Pure Audio, or Orchestra listening mode is selected, the center speaker produces no sound (page 61).
- Make sure the speakers are configured correctly (page 46).

The surround back speakers produce no sound?

- The surround back speakers are not used with all listening modes. Select another listening mode (page 60).
- Not much sound may be produced by the surround back speakers with some sources.
- Make sure the speakers are configured correctly (page 46).

Troubleshooting—Continued

The subwoofer produces no sound?

- When you play source material that contains no information in the LFE channel, the subwoofer produces no sound.
- Make sure the speakers are configured correctly (page 46).

There's no sound with a certain signal format?

- Check the digital audio output setting on the connected device. On some games consoles, such as those that support DVD, the default setting is off.
- With some DVD-Video discs, you need to select an audio output format from a menu.
- Depending on the input signal, some listening modes cannot be selected (page 59).

Can't select the DTS-ES Discrete/Matrix or THX Surround EX (DTR-6.5 only) listening modes?

- These modes cannot be selected when no surround back speakers are connected, or the Zone 2 speakers are being used.

Can't get 6.1 playback?

- If no surround back speakers are connected, or the Zone 2 speakers are being used, 6.1 playback is not possible.

The volume cannot be set to 99?

- When the levels of all speakers have been calibrated (page 50), the maximum volume setting may change.

Noise can be heard?

- Using cable ties to bundle audio cables with power cords, speaker cables, and so on may degrade the audio performance, so don't do it.
- An audio cable may be picking up interference. Try repositioning your cables.

The Late Night function doesn't work?

- Make sure the source material is Dolby Digital (page 62).

The DVD analog multichannel input doesn't work?

- Check the DVD analog multichannel input connections (page 29).
- To select the DVD analog multichannel input, press the [Multi CH] input selector button.
- Check the audio output settings on your DVD player.

About DTS signals

- When DTS program material ends and the DTS bitstream stops, the AV receiver remains in DTS listening mode and the DTS indicator remains on. This is to prevent noise when you use the pause, fast forward, or fast reverse function on your player. If you switch your player from DTS to PCM, because the AV receiver does not switch formats immediately, you may not hear any sound, in which case you should stop your player for about three seconds, and then resume playback.
- With some CD and LD players, you won't be able to playback DTS material properly even though your player is connected to a digital input on the AV receiver. This is usually because the DTS bitstream has been processed (e.g., output level, sampling rate, or frequency response changed) and the AV receiver doesn't recognize it as a genuine DTS signal. In such cases, you may hear noise.
- When playing DTS program material, using the pause, fast forward, or fast reverse function on your player may produce a short audible noise. This is not a malfunction.

Video

There's no picture?

- Make sure that all video connecting plugs are pushed in all the way (page 21).
- Make sure that each video component is properly connected.
- If your video component is connected to a component video input, your TV must be connected to the component video output (page 26).
- On your TV, make sure that the video input to which the AV receiver is connected is selected.
- While the Pure Audio listening mode is selected, the video circuits are turned off and the AV receiver outputs no video signals.

The onscreen menus don't appear?

- Make sure that the video settings are correct (page 43).
- On your TV, make sure that the video input to which the AV receiver is connected is selected.
- Depending on the display device, when the "b. Scan Mode" setting on the "6-3. OSD Setup" menu is set to Non-Interlaced, the onscreen setup menus may not appear. If this happens, use the AV receiver's display and change that setting to Interlaced.

Troubleshooting—Continued

Tuner

Reception is noisy, FM stereo reception is noisy, or the FM STEREO indicator doesn't appear?

- Relocate your antenna.
- Move the AV receiver away from your TV or computer.
- Listen to the station in mono (page 56).
- When listening to an AM station, operating the remote controller may cause noise.
- Passing cars and airplanes can cause interference.
- Concrete walls weaken radio signals.
- If nothing improves the reception, install an outdoor antenna.

Remote Controller

The remote controller doesn't work?

- Make sure that the batteries are installed with the correct polarity (page 13).
- Install new batteries. Don't mix different types of batteries, or old and new batteries (page 13).
- Make sure that the remote controller is not too far away from the AV receiver, and that there's no obstruction between the remote controller and the AV receiver's remote control sensor (page 13).
- Make sure that the AV receiver is not subjected to direct sunshine or inverter-type fluorescent lights. Relocate if necessary.
- If the AV receiver is installed in a rack or cabinet with colored-glass doors, the remote controller may not work reliably when the doors are closed.
- Make sure you've selected the correct remote controller mode (page 13).
- When using the remote controller to control other manufacturers' AV components, some buttons may not work as expected.
- Make sure you've entered the correct remote control code.

Can't control other components?

- If it's an Integra component, make sure that the **RI** cable and analog audio cable are connected properly. Connecting only an **RI** cable won't work (page 37).
- Make sure you've selected the correct remote controller mode (page 14).
- If you connect an MD recorder or CD recorder to the TAPE jacks, be sure to set make the necessary setting (pages 52 and 80).
- When learning commands, make sure that the transmitting ends of both remote controllers are pointing at each other.

- Are you trying to learn from a remote controller that cannot be used for learning? Some commands cannot be learnt, especially those that transmit several instructions with a single button press.
- The wrong remote control code has been entered.
- The entered remote control code may not be correct. If more than one code is listed, try each one.
- With some AV components, certain buttons may not work as expected, and some may not work at all.
- To control Integra components, point the remote controller at the AV receiver.
- To control another manufacturer's component, point the remote controller at that component.

Recording

Can't record?

- On your recorder, make sure the correct input is selected (e.g., digital or analog).

Zone 2

Zone 2 has turned off?

- Was the Sleep function set? The Sleep function turns off Zone 2 as well as the AV receiver. To set the Sleep function for Zone 2 only, see page 77.

There's no sound?

- Since the Zone 2 function and the REC OUT outputs use the same circuitry, you cannot use Zone 2 and record at the same time. When the [Rec Out] button is pressed, Zone 2 is turned off.
- Only components connected to analog inputs can be played in Zone 2.

Troubleshooting—Continued

Others

The sound changes when I connect my headphones?

- When a pair of headphones is connected, the listening mode is set to Stereo, unless it's already set to Stereo, Direct, or Pure Audio. When you disconnect the headphones, the previous listening mode will be resumed.

The speaker volume cannot be set as required?

- When the Automatic Speaker Setup function is used, or the volume is adjusted on the onscreen setup menus, the maximum possible volume setting may change.

The speaker distance cannot be set as required?

- In some cases, corrected values suitable for home theater use may be set automatically.

The display doesn't work?

- The display is turned off when the Pure Audio listening mode is selected.
- Actions are not displayed on the TV or projector that's connected to the COMPONENT VIDEO OUT.

How do I change the language of a multiplex source?

- Use the "a. Input Channel" setting on the "3-5. Multiplex" menu to select Main or Sub (page 67).

The AV receiver contains a microcomputer for signal processing and control functions. In very rare situations, severe interference, noise from an external source, or static electricity may cause it to lockup. In the unlikely event that this happens, unplug the power cord from the wall outlet, wait at least five seconds, and then plug it back in again.

Onkyo is not responsible for damages (such as CD rental fees) due to unsuccessful recordings caused by the unit's malfunction. Before you record important data, make sure that the material will be recorded correctly.

Resetting the AV receiver to its factory defaults
To reset the AV receiver to its factory defaults, turn it on and, while holding down the [VIDEO 1] button, press the [Standby/On] button. "CLEAR" will appear on the display and the AV receiver will enter Standby mode.

The AV receiver uses a battery-less memory backup system in order to retain radio presets and other settings when it's unplugged or in the case of a power failure. Although no batteries are required, the AV receiver must be plugged into an AC outlet in order to charge the backup system.

Specifications (DTR-6.5)

Amplifier Section

Power Output (2 channels driven):	100 W + 100 W (8Ω,20Hz-20kHz,FTC) 130 W + 130 W (6Ω,1kHz,DIN) 160 W + 160 W (6Ω,1kHz,JEITA)
Dynamic Power	230 W + 230 W (3Ω,Front) 170 W + 170 W (4Ω,Front) 115 W + 115 W (8Ω,Front)
THD (Total Harmonic Distortion)	0.08 % (Power Rated)
Damping Factor	60 (Front,1kHz,8Ω)
Input Sensitivity and Impedance	200 mV/ 47 kΩ (LINE) 2.5 mV/ 4.7 kΩ (PHONO MM)
Output Level and Impedance	200 mV/ 470 Ω (REC OUT)
Phono Overload	70 mV (MM 1kHz 0.5 %)
Frequency Response	10 Hz-100 kHz/ +1 dB-3 dB (Direct mode)
Tone Control	±10 dB, 50 Hz (BASS) ±10 dB, 10 kHz (TREBLE)
SN Ratio	106 dB (LINE,IHF-A) 80 dB (PHONO,IHF-A)
Speaker Impedance	American : 6Ω~ other :4 Ω~

Video Section

Input Sensitivity/Output Level and Impedance	1 Vp-p /75Ω (Component and S-Video Y) 0.7 Vp-p /75Ω (Component Pb/Cb,Pr/Cr) 0.28 Vp-p /75Ω(S-Video C) 1 Vp-p /75Ω(Composite)
Component Video Frequency Response	5 Hz - 50 MHz

Tuner Section

FM

Tuning Frequency Range	American: 87.5 MHz- 107.9 MHz Other : 87.5 MHz- 108.0 MHz
Usable Sensitivity	Stereo; 17.2 dBf 2 μV(75Ω IHF) Mono; 11.2 dBf 1 μV(75Ω IHF)
S/N Ratio	Stereo; 70 dB (IHF-A) Mono; 76 dB (IHF-A)
THD	Stereo; 0.3 % (1kHz) Mono 0.2 % (1kHz)
Frequency Response	30 Hz-15 kHz / ±1 dB
Stereo Separation	45 dB (1kHz)

AM

Tuning Frequency Range	American: 530 kHz-1700 kHz Others: 522 kHz-1611 kHz
Usable Sensitivity	30 μV
S/N Ratio	40 dB
THD	0.70%

General

Power Supply	American: AC 120 V, 60 Hz Australian: AC 230-240 V, 50 Hz
Power Consumption	American : 8.1A Others : 700 W
Stand-by Power Consumption	1.0 W
Dimensions(W x H x D)	435 W x 175 H x 428 D mm 17-1/8" W x 6-7/8" H x 16-7/8" D inches
Weight	15.2 kg 33.5 lbs

Video Inputs

Component Video Input	1,2,3
S-Video Compatible Jack Input	DVD,VIDEO1,VIDEO2,VIDEO3, VIDEO4
A/V Input	DVD,VIDEO1,VIDEO2,VIDEO3, VIDEO4

Video Outputs

Component Video Output	OUT
S-Video Compatible Jack Output	MONITOR OUT,VIDEO1,VIDEO2
A/V Output	MONITOR OUT,VIDEO1,VIDEO2

Audio Inputs

Digital Inputs	Optical : 5 , 1 (Front Panel) Coaxial : 2
Analog Inputs	DVD(MULTICHANNEL),VIDEO1, VIDEO2,VIDEO3,VIDEO4,TAPE,CD,PHONO
Multichannel Inputs	6

Audio Outputs

Digital Outputs	Optical : 1 Coaxial : 1
Analog Outputs	TAPE,VIDEO1,VIDEO2
Multichannel Pre Outputs	7
Subwoofer Pre Outputs	1
Speaker Outputs	9
Phones	1

Other Jacks

RS-232 Control	1
IR Input/Output	1
12V Trigger Out	3

Specifications and features are subject to change without notice.

Specifications (DTR-5.5)

Amplifier Section

Power Output (2 channels driven):	85 W + 85 W (8Ω,20Hz–20kHz, FTC) 120 W + 120 W (6Ω,1kHz,DIN) 150 W + 150 W (6Ω,1kHz,JEITA)
Dynamic Power	220 W + 220 W (3Ω,Front) 165 W + 165 W (4Ω,Front) 100 W + 100 W (8Ω,Front)
THD (Total Harmonic Distortion)	0.08 % (Power Rated)
Damping Factor	60 (Front,1kHz,8Ω)
Input Sensitivity and Impedance	200 mV/ 47 kΩ (LINE)
Output Level and Impedance	200 mV/ 470 Ω (REC OUT)
Frequency Response	10 Hz–100 kHz/ +1 dB-3 dB (Direct mode)
Tone Control	±10 dB, 50 Hz (BASS) ±10 dB, 10 kHz (TREBLE)
SN Ratio	106 dB (LINEIHF-A)
Speaker Impedance	American : 6Ω– Others :4 Ω–

Video Section

Input Sensitivity/Output Level and Impedance	1 Vp-p /75Ω (Component and S-Video Y) 0.7 Vp-p /75Ω (Component Pb/Cb,Pr/Cr) 0.28 Vp-p /75Ω(S-Video C) 1 Vp-p /75Ω(Composite)
Component Video Frequency Response	5 Hz – 50 MHz

Tuner Section

■ FM

Tuning Frequency Range	American; 87.5 MHz– 107.9 MHz Others; 87.5 MHz– 108.0 MHz
Usable Sensitivity	Stereo:17.2 dBf 2 μV(75Ω IHF) Mono: 11.2 dBf 1 μV(75Ω IHF)
S/N Ratio	Stereo: 70 dB (IHF-A) Mono:76 dB (IHF-A)
THD	Stereo: 0.3 % (1kHz) Mono:0.2 % (1kHz)
Frequency Response	30 Hz–15 kHz / ±1 dB
Stereo Separation	45 dB (1kHz)

■ AM

Tuning Frequency Range	American; 530 kHz–1700 kHz Others; 522 kHz–1611 kHz
Usable Sensitivity	30 μV
S/N Ratio	40 dB
THD	0.70%

General

Power Supply	American: AC 120 V, 60 Hz Australian: AC 230-240 V, 50 Hz
Power Consumption	American : 6.7A Others: 650 W
Stand-by Power Consumption	1.0 W
Dimensions(W x H x D)	435 W x 175 H x 428 D mm 17-1/8" W x 6-7/8" H x 16-7/8" D inches
Weight	13.4 kg 29.5 lbs

■ Video Inputs

Component Video Input	1,2,3
S-Video Compatible Jack Input	DVD,VIDEO1,VIDEO2,VIDEO3, VIDEO4
A/V Input	DVD,VIDEO1,VIDEO2,VIDEO3, VIDEO4

■ Video Outputs

Component Video Output	OUT
S-Video Compatible Jack Output	MONITOR OUT,VIDEO1,VIDEO2
A/V Output	MONITOR OUT,VIDEO1,VIDEO2

■ Audio Inputs

Digital Inputs	Optical :4(American)/ 3(other) 1 (Front Panel) Coaxial : 2
Analog Inputs	DVD(MULTICHANNEL),VIDEO1, VIDEO2,VIDEO3,VIDEO4,TAPE,CD
Multichannel Inputs	6

■ Audio Outputs

Digital Outputs	1 (Optical) 0 (Coaxial)
Analog Outputs	TAPE,VIDEO1,VIDEO2
Subwoofer Pre Outputs	1
Speaker Outputs	9
Phones	1

■ Other Jacks

RS-232 Control	1
IR Input/Output	1
12V Trigger Out	3

Specifications and features are subject to change without notice.

Integra Division of
ONKYO U.S.A. CORPORATION
18 park Way, Upper Saddle River, N.J. 07458, U.S.A.
Tel: 201-785-2600 Fax: 201-785-2650 <http://www.integrahometheater.com>

Integra Division of
ONKYO CORPORATION
Sales & Product Planning Div.: 2-1, Nisshin-cho, Neyagawa-shi, OSAKA 572-8540, JAPAN
Tel: 072-831-8023 Fax: 072-831-8124



I0407-1

SN 29343827
(C) Copyright 2004 ONKYO CORPORATION Japan. All rights reserved.



Free Manuals Download Website

<http://myh66.com>

<http://usermanuals.us>

<http://www.somanuals.com>

<http://www.4manuals.cc>

<http://www.manual-lib.com>

<http://www.404manual.com>

<http://www.luxmanual.com>

<http://aubethermostatmanual.com>

Golf course search by state

<http://golfingnear.com>

Email search by domain

<http://emailbydomain.com>

Auto manuals search

<http://auto.somanuals.com>

TV manuals search

<http://tv.somanuals.com>