

Integra

AV Receiver

DTR-7.1

Instruction Manual

Thank you for purchasing the Integra AV Receiver. Please read this manual thoroughly before making connections and turning on the power. Following the instructions in this manual will enable you to obtain optimum performance and listening enjoyment from your new AV Receiver. Please retain this manual for future reference.

Contents

Before using 2

Facilities and connections 8

Setting OSD menu 28

Enjoying music or videos 48

Remote controller 56

Appendix 68

WARNING:

TO REDUCE THE RISK OF FIRE OR ELECTRIC SHOCK, DO NOT EXPOSE THIS APPLIANCE TO RAIN OR MOISTURE.

CAUTION:

TO REDUCE THE RISK OF ELECTRIC SHOCK, DO NOT REMOVE COVER (OR BACK). NO USER-SERVICEABLE PARTS INSIDE. REFER SERVICING TO QUALIFIED SERVICE PERSONNEL.



WARNING
RISK OF ELECTRIC SHOCK
DO NOT OPEN

AVIS
RISQUE DE CHOC ELECTRIQUE
NE PAS OUVRIR



The lightning flash with arrowhead symbol, within an equilateral triangle, is intended to alert the user to the presence of uninsulated "dangerous voltage" within the product's enclosure that may be of sufficient magnitude to constitute a risk of electric shock to persons.



The exclamation point within an equilateral triangle is intended to alert the user to the presence of important operating and maintenance (servicing) instructions in the literature accompanying the appliance.

Important Safeguards

- 1. Read Instructions** – All the safety and operating instructions should be read before the appliance is operated.
- 2. Retain Instructions** – The safety and operating instructions should be retained for future reference.
- 3. Heed Warnings** – All warnings on the appliance and in the operating instructions should be adhered to.
- 4. Follow Instructions** – All operating and use instructions should be followed.
- 5. Cleaning** – Unplug the appliance from the wall outlet before cleaning. The appliance should be cleaned only as recommended by the manufacturer.
- 6. Attachments** – Do not use attachments not recommended by the appliance manufacturer as they may cause hazards.
- 7. Water and Moisture** – Do not use the appliance near water –for example, near a bath tub, wash bowl, kitchen sink, or laundry tub; in a wet basement; or near a swimming pool; and the like.
- 8. Accessories** – Do not place the appliance on an unstable cart, stand, tripod, bracket, or table. The appliance may fall, causing serious injury to a child or adult, and serious damage to the appliance. Use only with a cart, stand, tripod, bracket, or table recommended by the manufacturer, or sold with the appliance. Any mounting of the appliance should follow the manufacturer's instructions, and should use a mounting accessory recommended by the manufacturer.
- 9. An appliance and cart combination** should be moved with care. Quick stops, excessive force, and uneven surfaces may cause the appliance and cart combination to overturn.
- 10. Ventilation** – Slots and openings in the cabinet are provided for ventilation and to ensure reliable operation of the appliance and to protect it from overheating, and these openings must not be blocked or covered. The openings should never be blocked by placing the appliance on a bed, sofa, rug, or other similar surface. The appliance should not be placed in a built-in installation such as a bookcase or rack unless proper ventilation is provided. There should be free space of at least 20 cm (8 in.) and an opening behind the appliance.
- 11. Power Sources** – The appliance should be operated only from the type of power source indicated on the marking label. If you are not sure of the type of power supply to your home, consult your appliance dealer or local power company.
- 12. Grounding or Polarization** – The appliance may be equipped with a polarized alternating current line plug (a plug having one blade wider than the other). This plug will fit into the power outlet only one way. This is a safety feature. If you are unable to insert the plug fully into the outlet, try reversing the plug. If the plug should still fail to fit, contact your electrician to replace your obsolete outlet. Do not defeat the safety purpose of the polarized plug.
- 13. Power-Cord Protection** – Power-supply cords should be routed so that they are not likely to be walked on or pinched by items placed upon or against them, paying particular attention to cords at plugs, convenience receptacles, and the point where they exit from the appliance.
- 14. Outdoor Antenna Grounding** – If an outside antenna or cable system is connected to the appliance, be sure the antenna or cable system is grounded so as to provide some protection against voltage surges and built-up static charges. Article 810 of the National Electrical Code, ANSI/NFPA 70, provides information with regard to proper grounding of the mast and supporting structure, grounding of the lead-in wire to an antenna-discharge unit, size of grounding conductors, location of antenna-discharge unit, connection to grounding electrodes, and requirements for the grounding electrode. See Figure 1.
- 15. Lightning** – For added protection for the appliance during a lightning storm, or when it is left unattended and unused for long periods of time, unplug it from the wall outlet and disconnect the antenna or cable system. This will prevent damage to the appliance due to lightning and power-line surges.
- 16. Power Lines** – An outside antenna system should not be located in the vicinity of overhead power lines or other electric light or power circuits, or where it can fall into such power lines or circuits. When installing an outside antenna system, extreme care should be taken to keep from touching such power lines or circuits as contact with them might be fatal.
- 17. Overloading** – Do not overload wall outlets, extension cords, or integral convenience receptacles as this can result in a risk of fire or electric shock.
- 18. Object and Liquid Entry** – Never push objects of any kind into the appliance through openings as they may touch dangerous voltage points or short-out parts that could result in a fire or electric shock. Never spill liquid of any kind on the appliance.
- 19. Servicing** – Do not attempt to service the appliance yourself as opening or removing covers may expose you to dangerous voltage or other hazards. Refer all servicing to qualified service personnel.
- 20. Damage Requiring Service** – Unplug the appliance from the wall outlet and refer servicing to qualified service personnel under the following conditions:
 - When the power-supply cord or plug is damaged,
 - If liquid has been spilled, or objects have fallen into the appliance,
 - If the appliance has been exposed to rain or water,
 - If the appliance does not operate normally by following the operating instructions. Adjust only those controls that are covered by the operating instructions as an improper adjustment of other controls may result in damage and will often require extensive work by a qualified technician to restore the appliance to its normal operation,
 - If the appliance has been dropped or damaged in any way, and
 - When the appliance exhibits a distinct change in performance – this indicates a need for service.

PORTABLE CART WARNING



S3125A

21. **Replacement Parts** – When replacement parts are required, be sure the service technician has used replacement parts specified by the manufacturer or have the same characteristics as the original part. Unauthorized substitutions may result in fire, electric shock, or other hazards.
22. **Safety Check** – Upon completion of any service or repairs to the appliance, ask the service technician to perform safety checks to determine that the appliance is in proper operation condition.
23. **Wall or Ceiling Mounting** – The appliance should be mounted to a wall or ceiling only as recommended by the manufacturer.
24. **Heat** – The appliance should be situated away from heat sources such as radiators, heat registers, stoves, or other appliances (including amplifiers) that produce heat.

Precautions

1. Warranty Claim

You can find the serial number on the rear panel of this unit. In case of warranty claim, please report this number.

2. Recording Copyright

Recording of copyrighted material for other than personal use is illegal without permission of the copyright holder.

3. AC Fuse

The fuse is located inside the chassis and is not user-serviceable. If power does not come on, contact your Integra/Onkyo authorized service station.

4. Care

From time to time you should wipe the front and rear panels and the cabinet with a soft cloth. For heavier dirt, dampen a soft cloth in a weak solution of mild detergent and water, wring it out dry, and wipe off the dirt. Following this, dry immediately with a clean cloth. Do not use rough material, thinners, alcohol or other chemical solvents or cloths since these could damage the finish or remove the panel lettering.

5. Power

WARNING

BEFORE PLUGGING IN THE UNIT FOR THE FIRST TIME, READ THE FOLLOWING SECTION CAREFULLY.

The voltage of the available power supply differs according to country or region. Be sure that the power supply voltage of the area where this unit will be used meets the required voltage (e.g., AC 120 V, 60 Hz) written on the rear panel.

FIGURE 1:
EXAMPLE OF ANTENNA GROUNDING AS PER NATIONAL
ELECTRICAL CODE, ANSI/NFPA 70

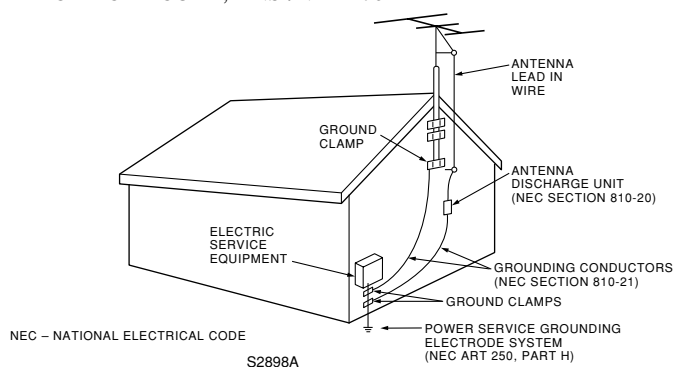

For U.S. models

Note to CATV system installer:

This reminder is provided to call the CATV system installer's attention to Article 820-40 of the NEC, ANSI/NFPA 70, which provides guidelines for proper grounding and, in particular, specifies that the cable ground shall be connected to the grounding system of the building, as close to the point of cable entry as practical.

FCC Information for User

CAUTION:

The user changes or modifications not expressly approved by the party responsible for compliance could void the user's authority to operate the equipment.

NOTE:

This equipment has been tested and found to comply with the limits for a Class B digital device, pursuant to Part 15 of the FCC Rules. These limits are designed to provide reasonable protection against harmful interference in a residential installation. This equipment generates, uses and can radiate radio frequency energy and, if not installed and used in accordance with the instructions, may cause harmful interference to radio communications. However, there is no guarantee that interference will not occur in a particular installation. If this equipment does cause harmful interference to radio or television reception, which can be determined by turning the equipment off and on, the user is encouraged to try to correct the interference by one or more of the following measures:

- Reorient or relocate the receiving antenna.
- Increase the separation between the equipment and receiver.
- Connect the equipment into an outlet on a circuit different from that to which the receiver is connected.
- Consult the dealer or an experienced radio/TV technician for help.

For Canadian models

NOTE:

THIS CLASS B DIGITAL APPARATUS COMPLIES WITH CANADIAN ICES-003.

For models having a power cord with a polarized plug:

CAUTION: TO PREVENT ELECTRIC SHOCK, MATCH WIDE BLADE OF PLUG TO WIDE SLOT, FULLY INSERT.

Modele pour les Canadien

REMARQUE:

CET APPAREIL NUMÉRIQUE DE LA CLASSE B EST CONFORME À LA NORME NMB-003 DU CANADA.

Sur les modèles dont la fiche est polarisée:

ATTENTION: POUR ÉVITER LES CHOCS ÉLECTRIQUES, INTRODUIRE LA LAME LA PLUS LARGE DE LA FICHE DANS LA BORNE CORRESPONDANTE DE LA PRISE ET POUSSER JUSQU'AU FOND.

Contents

Before using

Important Safeguards	2
Precautions	3
Contents	4
Supplied accessories	5
Features	6
Before using this unit	7
Installing the remote controller batteries	7
Using the remote controller	7

Facilities and connections

Front panel facilities	8
Front panel	9
Front panel display	10
Remote controller	11
Rear panel facilities	12
Example of how to connect your equipment	16
Standard connections	17
Connecting your audio components	18
Connecting your video components	18
Connecting speakers	20
Ideal speaker configuration	20
Minimum speaker configuration for surround sound playback	20
Speaker placement	20
Connecting speakers	21
Connecting the speaker cable	21
Connecting a subwoofer	21
Connecting antennas	22
Assembling the AM loop antenna	22
Connecting the AM antenna cable	22
Connecting the included antennas	22
Connecting an FM outdoor antenna	23
Connecting an AM outdoor antenna	23
Directional linkage	23
Connecting to the remote zone input	24
When using the ZONE 2 SPEAKERS terminals	24
When using the ZONE 2 OUT terminals	25
Connecting to the IR IN MAIN input	25
Connecting power amplifiers and two surround back speakers	26
Connecting power amplifiers	26
Connecting two surround back speakers	26
Connecting the power	27
Connecting the power	27

Setting OSD menu

The On-Screen Display (OSD) menu	28
Navigating through the OSD menu	29
Speaker Setup	30
1. Speaker Setup menu	30
1-1. Speaker Config sub-menu	30
1-2. Speaker Distance sub-menu	31
1-3. Level Calibration sub-menu	32
1-4. Bass Peak Level sub-menu	33
Input Setup	34
2. Input Setup menu	34
2-1. Audio Setup sub-menu	34
2-2. Video Setup sub-menu	36
2-3. Listening Mode Preset sub-menu	37
Input source signals	37
Listening modes	38
2-4. Tone Control sub-menu	40
2-5. IntelliVolume sub-menu	40
2-6. 12V Trigger sub-menu	40
Listening Mode Setup	41
3. Listening Mode Setup menu	41
Description listening mode parameters	43
Preference	45
4. Preference menu	45
4-1. Volume Setup sub-menu	45
4-2. Headphones Level sub-menu	45
4-3. DTS LFE Level Setup sub-menu	45
4-4. Powered Zone 2 Setup sub-menu	45
OSD Setup	46
5. OSD Setup menu	46
5-1. OSD Config sub-menu	46
5-2. OSD Setup sub-menu	47
5-3. OSD Position sub-menu	47

Enjoying music or videos

Enjoying music in the remote zone	48
Controlling the DTR-7.1 from the remote zone	48
Controlling the DTR-7.1 without the remote controller	48
Listening to Radio Broadcasts	49
Listening to FM/AM Radio Stations	49
Tuning into a radio station	49
Presetting a radio station	50
Selecting a preset radio station	50
Erasing a preset radio station	50

Contents

Enjoying music or videos with the DTR-7.1	51
Selecting an input source	51
Adjusting the volume	51
Changing the listening mode	51
Listening with headphones	51
Using the many features of the DTR-7.1	52
If one of the messages shown below appears	52
Enjoying the multichannel input	52

Recording a source	53
To record the input source signal you are currently watching or listening to	53
To record an input source signal different from that you are currently watching or listening to	54
Recording the video from one source and the audio from another	54

Giving a name to each input source and preset radio station	55
Giving a name to each input source	55
To change a name	55
To erase a name	55
Giving a name to each preset radio station	55

Remote controller

Using remote controller	56
Overview	56
Using the remote controller to control each device	56
Controlling the DTR-7.1	56
Controlling an Integra/Onkyo CD player	58
Controlling an Integra/Onkyo MD recorder	58
Controlling an Integra/Onkyo cassette tape deck	59
Calling up a preset radio station	59
Controlling an Integra/Onkyo DVD player	60
SAT, CABLE, VCR, and TV MODE buttons	60

Programming the commands of remote controllers for other devices into the remote controller

61	
Programming procedure	61
Erasing the programmed command from one button	63
Erasing all the commands programmed under a MODE button ..	63
Using a Macro function	64
What is a Macro function?	64
Programming a Macro function	64
Running a Macro function	64
Programming the Direct Macro function	65
Running a Direct Macro function	65
Erasing a macro from the MODE MACRO button	66
Erasing a direct macro from the DIRECT MACRO button	66
Erasing all commands and macros that have been programmed	67
(Macro mode programming memo	67)

Appendix

Troubleshooting guide	68
POWER	68
SPEAKERS	68
FM/AM TUNER	69
VIDEO and AUDIO	69
REMOTE CONTROLLER	70
OTHER	70
Specifications	71

Supplied accessories

Check that the following accessories are supplied with the DTR-7.1.

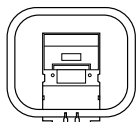

AM loop antenna × 1

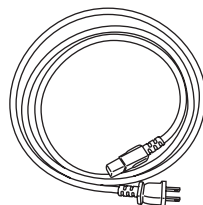

Power cord × 1

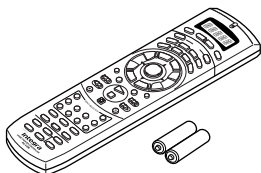

Remote controller × 1
Batteries (AA, R6 or UM-3) × 2

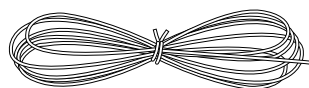

FM indoor antenna × 1

Features

- THX Surround EX®
- THX® Select Certified
- Dolby® Digital, DTS®, Dolby® Pro Logic™
- Theater-Dimensional™ Virtual Surround Mode
- Cinema Re-EQ™ Circuitry
- 100 W×2 (Front), 100 W (Center), 100 W×2 (Surround), 100 W (Surround Back) at 8 Ω, 20Hz-20kHz, 0.08% THD (FTC)
- Wide Range Amplifier Technology (WRAT)
- All Discrete Output Stage
- 96kHz/24Bit D/A Converters
- DVD-Audio Capability
- 12 V DC Trigger (A, B)
- Listening mode Input Memory
- HDTV Ready Component Video Circuit (45 MHz (-3 dB))
- 4 Digital Inputs (2 Coaxial and 2 Optical) and 1 Digital Output (Optical)
- 3 Audio Inputs and 5 A/V Inputs
- 5 S-Video Inputs and 3 S-Video Outputs
- 2 Component Video Inputs and 1 Component Video Output
- Pre Out Terminals for Front L/R, Center, Surround L/R, Surround back L/R and Subwoofer
- Heavy-Duty Multiway Speaker Binding Posts for All Channels; All Dual Banana-Plug Compatible
- Zone 2 Powered capability
- Powerful Backlit Learning Remote with Macro Functions and LCD Display
- IntelliVolume
- Character Input

- * Manufactured under license from Dolby Laboratories. "Dolby", "Pro Logic" and the double-D symbol are trademarks of Dolby Laboratories. Confidential Unpublished Works. ©1992-1997 Dolby Laboratories, Inc. All rights reserved.
- "Theater-Dimensional" and  are trademarks of Onkyo Corporation.
 - Lucasfilm, THX, THX Select and THX Surround EX are registered trademarks of Lucasfilm LTD.
 - Re-Equalization and the "Re-EQ" logo are trademarks of Lucasfilm Ltd. Manufactured under license of Lucasfilm Ltd.
 - Manufactured under license from Digital Theater Systems, Inc. US Pat. No.5,451,942 and other worldwide patents issued and pending. "DTS" and "DTS Digital Surround" are trademarks of Digital Theater Systems, Inc. © 1996 Digital Theater Systems, Inc. All rights reserved.
 - Xantech is a registered trademark of Xantech Corporation.
 - Niles is a registered trademark of Niles Audio Corporation.

THX Select

Before any home theatre component can be THX Select certified, it must pass a rigorous series of quality and performance tests. Only then can a product feature the THX Select logo, which is your guarantee that the Home Theatre products you purchase will give you superb performance for many years to come. THX Select requirements define hundreds of parameters, including power amplifier performance, and pre-amplifier performance and operation for both digital and analog domains. THX Select receivers also feature proprietary THX technologies (e.g., THX Mode, see page 38) which accurately translate film soundtracks for home theater playback.

Before using this unit

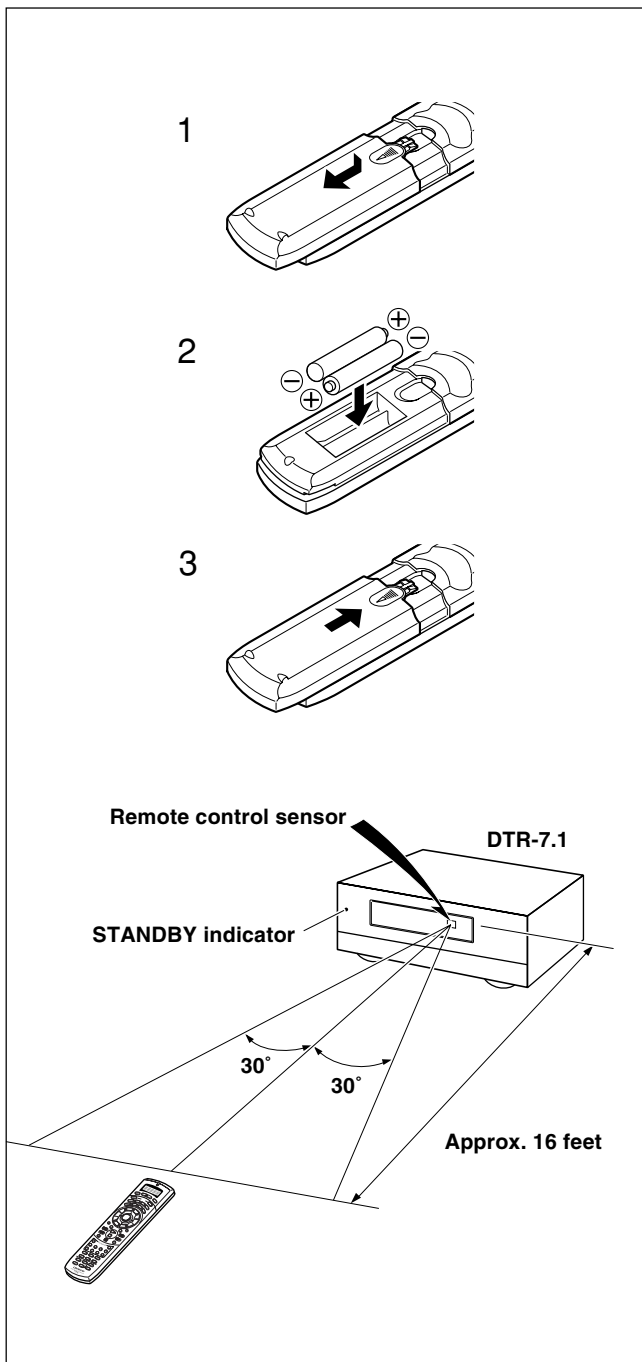

Installing the remote controller batteries

1. Remove the battery compartment cover by pressing and sliding the cover.
2. Insert two AA (R6 or UM-3) batteries into the battery compartment. Carefully follow the polarity diagram (positive (+) and negative (-) symbols) inside the battery compartment.
3. After batteries are installed and seated correctly, replace the compartment cover.

Notes:

- Do not mix new batteries with old batteries or different kinds of batteries.
- To avoid corrosion, remove the batteries if the remote controller is not to be used for a long time.
- Remove dead batteries immediately to avoid damage from corrosion. If the remote controller does not operate smoothly, replace both the batteries at the same time.
- The life of the batteries supplied is about six months but this will vary depending on usage.

Using the remote controller

Point the remote controller toward the remote control sensor. The STANDBY indicator lights up when the unit receives a signal from the remote controller.

Notes:

- Place the unit away from strong light such as direct sunlight or inverted fluorescent light which can prevent proper operation of the remote controller.
- Using another remote controller of the same type in the same room or using the unit near equipment which uses infrared rays may cause operational interference.
- Do not put objects on the remote controller. Its buttons may be pressed by mistake and drain the batteries.
- Make sure the audio rack doors do not have colored glass. Placing the unit behind such doors may prevent proper remote controller operation.
- If there is any obstacle between the remote controller and the remote control sensor, the remote controller will not operate.

Front panel facilities

Here is an explanation of the controls and displays on the front panel of the DTR-7.1.

Front panel

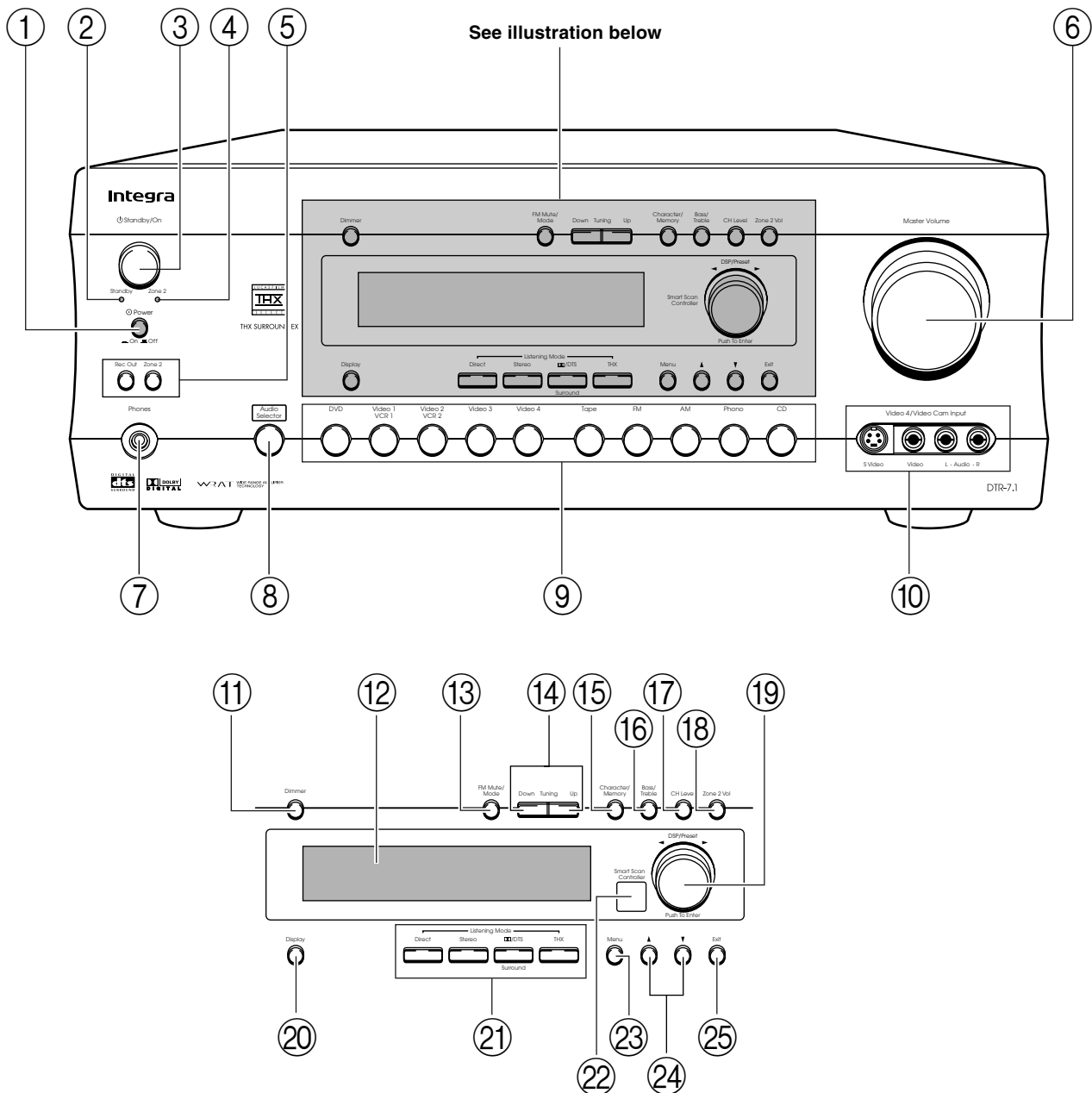

Front panel display

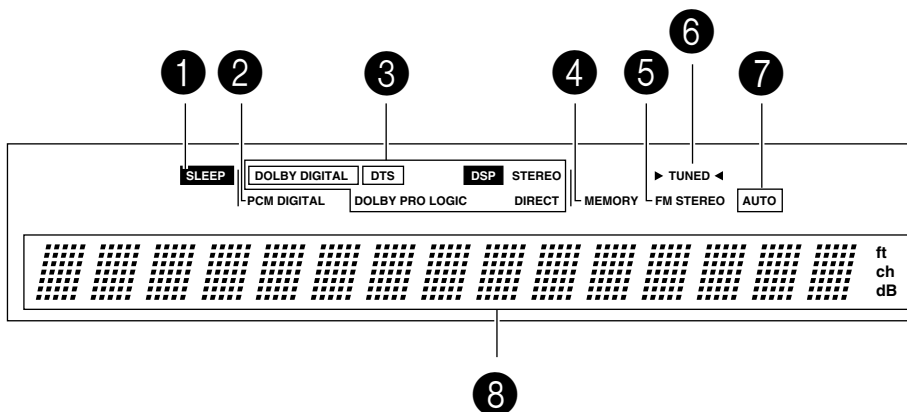

Front panel facilities

Front panel

① Power switch

After plugging in the power cord into the rear panel and wall outlet, pressing this button connects the DTR-7.1 to the AC mains and turns it on.

- Before turning on the power, make sure all cables are properly connected.
- Turning on the DTR-7.1 may cause a momentary power surge that might interfere with other electrical equipment on the same circuit. If this is a problem, plug the DTR-7.1 into a different electrical circuit.

② Standby indicator

Lights when the DTR-7.1 is in the standby state and flashes when a signal is received from the remote controller.

③ Standby/On button

Pressing this button while the main power is turned on the Standby indicator lights up and the front display turns off. Pressing it again returns it to the standby state. This state turns off the display, disables control functions.

④ Zone 2 indicator

Lights when a signal is output to the remote zone (Zone 2). When the Zone 2 indicator is off, then either output to the remote zone is turned off or Rec Out is selected.

⑤ Rec Out/Zone 2 buttons

These buttons allow you to use the DTR-7.1 to output to a remote zone (Zone 2) or to another component for recording purposes (Rec Out). Press the Rec Out button to output the audio and video signals to a recording component for recording purposes. Press the Zone 2 button to enjoy the output from the DTR-7.1 in a different room, which is referred to as a remote zone (Zone 2).

When either button is pressed, the currently selected input source for recording or outputting to the remote zone is displayed in the front panel display. If "SOURCE" is displayed, then the same input source as that selected for the main zone will be output.

To select an input source, press the desired button (Rec Out or Zone 2) and then press one of the input source button within 3 seconds. That source will be output for recording or viewing in the remote zone. To turn off either the Rec Out or Zone 2 output, when "SOURCE" is displayed, press the button again. "OFF" appears in the front display.

Notes:

- The Rec Out and Zone 2 buttons use the same circuit and therefore cannot be used at the same time. When Rec Out is selected, nothing is output to Zone 2, and vice versa.
- When not using Rec Out or Zone 2, turn off the signal. If turned on and the connected component is not turned on, the electric signal will still be sent through the circuitry and the excess load may cause deterioration of the audio signal.

⑥ Master Volume dial

The Master Volume dial is used to control the volume for the main zone. The volume for the remote zone (Zone 2) is independent.

⑦ Phones jack

This is a standard stereo jack for connecting stereo headphones. The audio for the front right and left speakers are sent to the headphone speakers. When the headphones are plugged in, the listening mode automatically changes to stereo and output to the speakers is stopped.

⑧ Audio Selector button

This button is used to select the type of audio input signal. Each time pressed, the setting cycles from "AUTO" → "Multichannel" → "Analog" and back.

AUTO (automatic detection): With this setting, the DTR-7.1 automatically detects whether the input signal is digital or analog. When a digital signal is not input, then the analog signal is played.

Multichannel: Select this setting to play back the input from the component connected to the MULTI CHANNEL INPUT port. This setting is effective when the Multichannel setting in the Audio Setup sub-menu is set to "Yes" (see page 35).

Analog: Select this setting to play back the input from a source component connected to an AUDIO IN jack. With this setting, even if a digital signal is input from the same component, only the analog signal will be output.

⑨ Input Source Buttons (DVD, Video 1–4, Tape, FM, AM, Phono, and CD)

These buttons are used to select the input source for the main zone. To select the input source for the remote zone (Zone 2) or recording out (Rec Out), first press the Zone 2 or Rec Out button, and then the desired input source button.

⑩ Video 4/Video Cam Input

These inputs are for connecting video cameras and other such equipment.

⑪ Dimmer button

Press to set the brightness of the front display. There are 3 settings available: normal, dark, and very dark.

- The dimmer control for the front display can also be performed at the remote controller.

⑫ Front display

⑬ FM Mute/Mode button

If you are listening to an FM radio station in stereo and the sound cuts out or there is a great deal of noise, switch from STEREO to MONO. Each time this button is pressed, the AUTO indication flashes and the stereo mode changes from AUTO to MONO and vice versa. This button also turns on and off the FM MUTE.

⑭ Tuning Up/Down button

Use these buttons to change the tuner frequency. The tuner frequency is displayed in the front display and it can be changed in 50 kHz increments for FM and 10 kHz (or 9 kHz) increments for AM.

When FM is selected, you can hold down one of the tuning buttons and then release it to activate the auto-search feature. It will search for a station in the direction of the button you pressed and stop when it tunes into one.

Front panel facilities

15 Character/Memory button

This button is used to program names to preset radio stations and input sources, to change names previously programmed, or to delete names. This button is also used to assign the radio station that is currently tuned in to a preset channel or delete a previously preset station.

16 Bass/Treble button

Press to enter the mode for adjusting the bass and treble levels.

17 CH Level button

Press to select the channel whose level is to be adjusted.

18 Zone 2 Vol button

Press to enter the mode for adjusting the volume in the remote zone (Zone 2).

19 Smart Scan Controller (SSC) dial

Turn clockwise or counterclockwise to select the setting for the parameter displayed in the front display. Press to move to the next parameter.

20 Display button

The Display button is used to display information about the current input source signal. Each time you press the display button, the screen changes to show you different information concerning the input signal.

When an input source other than FM or AM is selected:

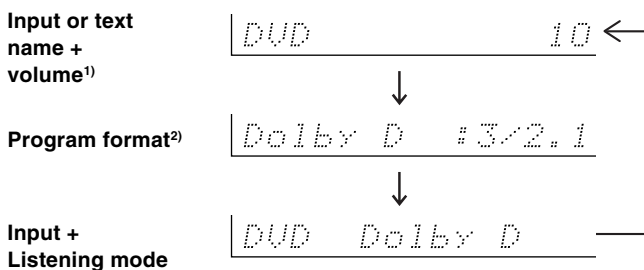

1) You can program text name for each input source (see page 52). That text name will be displayed at this time.

2) If the input signal does not have a program format, then this will be skipped.

When FM or AM is selected as the input source:

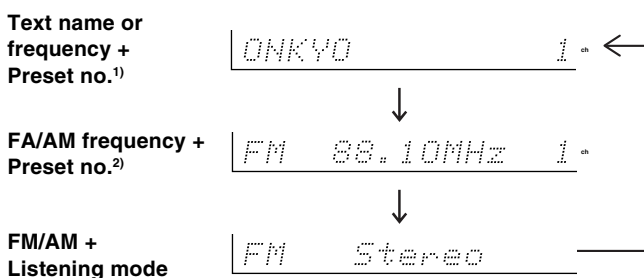

1) Not displayed if there is no text name programmed for the preset channel.

2) If a text name is programmed for the preset channel, display "2" is displayed for 3 seconds each time the input is changed from FM to AM or vice versa.

21 Listening Mode buttons

Press these buttons to select a listening mode for the current input source.

DIRECT: Select for direct audio output that does not pass through sound alteration circuits and other filters.

STEREO: Select for normal stereo output.

Dolby/DTS SURROUND: Select for the Dolby Pro Logic, Dolby Digital, or DTS listening modes.

THX: Select for the THX listening mode.

22 Remote control sensor

23 Menu button

Press to bring up the OSD menu. The OSD menu will appear on the TV monitor as well as the front display on the DTR-7.1.

24 ▲ and ▼ buttons

When selecting items in the OSD Menu, press these buttons to move the on-screen cursor (or the highlighted portion) upward and downward.

25 Exit button

Press to exit the OSD menu when at the Menu Screen, or move to one screen previous to the one that is displayed if at any other screen.

Front panel display

- 1 SLEEP indicator
- 2 PCM DIGITAL indicator
- 3 Listening mode or digital input format indicator
- 4 MEMORY indicator
- 5 FM STEREO indicator
Lights when tuned into an FM radio broadcast in stereo.
- 6 TUNED indicator
- 7 AUTO indicator
- 8 Multi function display

Remote controller

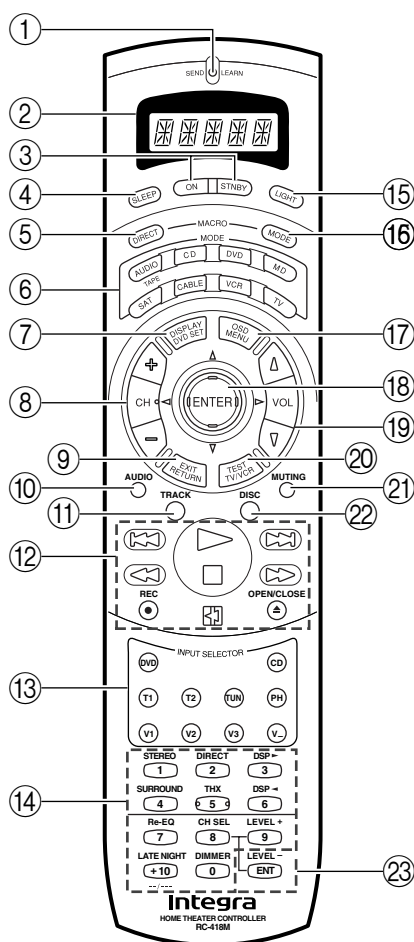

For a more detailed explanation of how to use the remote controller, refer to pages 58 through 69.

① SEND/LEARN indicator

Lights red when sending a signal.

② LCD display

Displays the component being operated or the operation status.

③ ON/STNBY button

ON: Turns on the DTR-7.1.

STNBY: Places the DTR-7.1 in the standby state.

Be aware that pressing the STNBY button only places the DTR-7.1 in standby and does not turn the power completely off.

④ SLEEP button

For setting the sleep time.

⑤ DIRECT MACRO button

For executing and programming the Direct Macro function.

⑥ MODE buttons

For selecting the component to be operated by the remote controller.

⑦ DISPLAY/DVD SET button

For changing the display in the front display. However, when in the DVD mode, this button displays the DVD setup menu.

⑧ CH +/- buttons

For selecting a tuner preset channel.

⑨ EXIT/RETURN button

For entering the selected setting and returning to the previous screen.

⑩ AUDIO button

For selecting the audio input signal. The setting changes from "AUTO" to "Multichannel" to "Analog" and back each time this button is pressed.

⑪ TRACK button

For selecting a track when playing back a compact disc.

⑫ CD/TAPE/DVD/MD operation buttons

For operating Onkyo components connected to the DTR-7.1.

⑬ Input Selector buttons

For selecting the input source. To select Video 4, press the V- button and then 4 of the numerical keys.

⑭ Numeric key/STEREO/DIRECT/THX/DSP +/-/SURROUND/Re-EQ/LATE NIGHT/CH SEL/LEVEL +/-/DIMMER buttons

For entering the number of a track.

You can also select a listening mode, set the speaker output level, and adjust the brightness of the front display (DIMMER).

⑮ LIGHT button

For illuminating the buttons of the remote controller.

⑯ MODE MACRO button

For executing and programming the Macro function.

⑰ OSD/MENU button

For displaying the OSD Menu. However, when in the DVD mode, this button displays the DVD menu.

⑱ ENTER/cursor button

When selecting items in the OSD Menu, press the upper and lower portions to move the on-screen cursor (or highlighted portion) upward and downward, press the right and left portions to select parameter values or modes, and press ENTER to display the screen for the selected item.

⑲ VOL +/- button

For adjusting the volume.

⑳ TEST/TV/VCR button

For setting the output levels for each speaker. Programs the TV/VCR switching mode when programming the remote controllers of other components.

㉑ MUTING button

Activates the mute function.

㉒ DISC button

For selecting the compact disc for playback when using a CD changer.

㉓ ENT button

For entering setting when operating MD or DVD players.

Rear panel facilities

Here is an explanation of the terminals found on the rear of the DTR-7.1 and how they are used. Before connecting your audio and video components, be sure to read this section carefully and then proceed to the explanations on how to connect each individual component (see pages 16).

- Be sure to always refer to the instructions that came with the component that you are connecting.
- Do not plug in the power cord until all connections have been made.
- For input jacks, red connectors (marked R) are used for the right channel, white connectors (marked L) are used for the left channel, and yellow connectors (marked V) are used for video connection.

- Insert all plugs and connectors securely. Improper connections can result in noise, poor performance, or damage to the equipment.

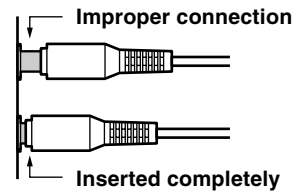

- Do not bind audio/video connection cables with power cords and speaker cables. Doing so may adversely affect the picture and sound quality.

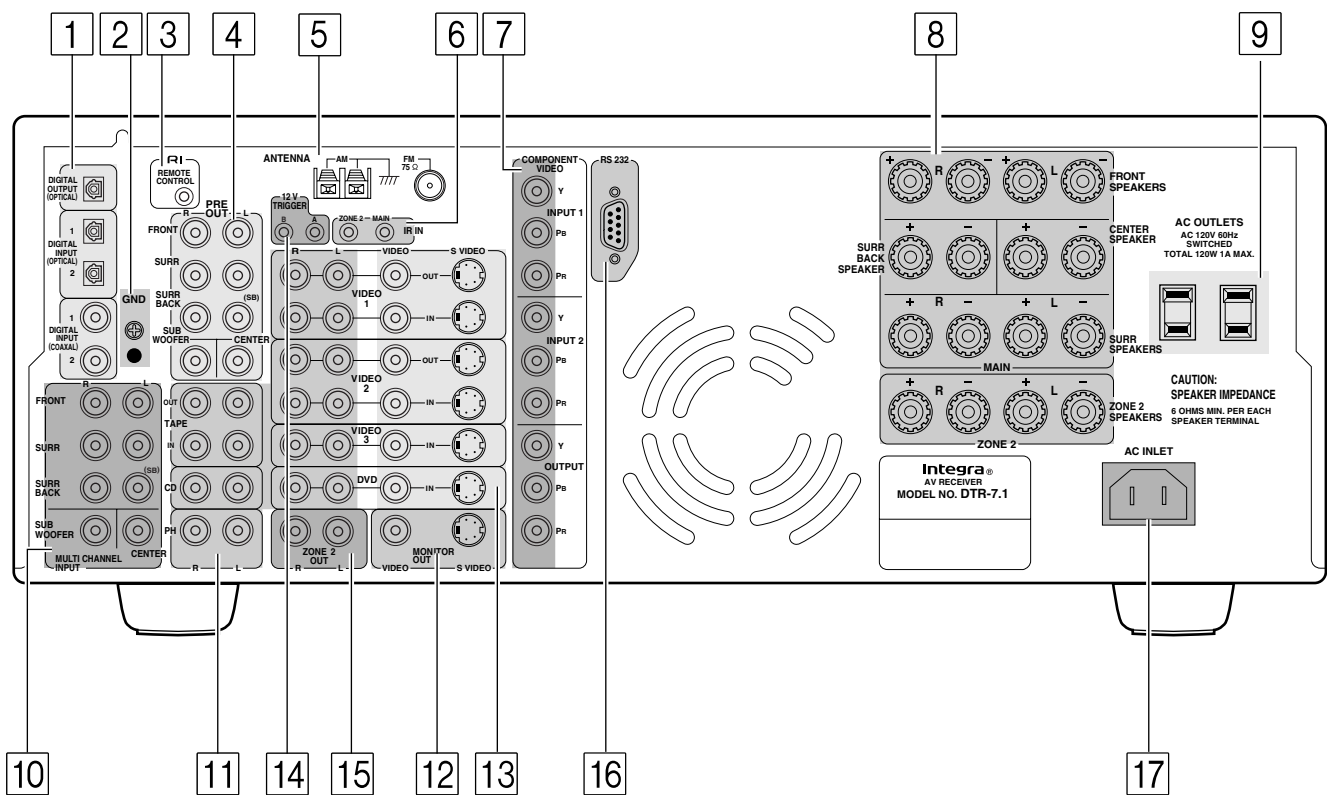

Rear panel facilities

1 DIGITAL INPUT/OUTPUT (coaxial and optical)

These are the digital audio inputs and outputs. There are 2 digital inputs with coaxial jacks and 2 with optical jacks. The inputs accept digital audio signals from a compact disc, LD, DVD, or other digital source component. For digital output, there is 1 optical output. The digital outputs can be connected to MD recorders, CD recorders, DAT decks, or other similar components.

- When using the digital inputs and outputs, make sure to also connect the analog connections whenever possible.
- When using one of the optical input or output jacks, remove the protective cap and keep it safely. When the jack is not used, replace the protective cap.
- When using an optical input or output jack, always use an optical fiber cable.

COAXIAL Coaxial cable

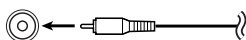

OPTICAL Optical fiber cable

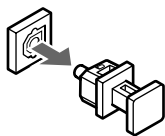

Optical digital input terminal

An optical digital input terminal is equipped with a protection cap. When connecting, remove this cap. When not using, put the cap back on the terminal.

2 GND

Use this GND terminal for connecting the ground (or earth) wire if a turntable is connected. Refer to "Connecting a turntable" on page 18.

3 RI (RI)

By connecting the **RI** connector as shown in the diagram below, you can use the RC-418M remote controller to operate Integra/Onkyo cassette tape decks and compact disc players that also have Integra/Onkyo's **RI** connectors. Simply connect a remote control cable from this connector to the **RI** connector of the cassette tape deck or compact disc player. An **RI** remote control cable with a 3.5-mm (1/8-inch) miniature two-conductor plug comes with every cassette tape deck and compact disc player that has an **RI** connector.

- For remote control operation, the audio connection cables must also be connected.
- The RC-418M remote controller does not support turntables.
- If the connected component has two **RI** connectors, you can use either one to connect to the DTR-7.1. The other one can be used to daisy chain with another component.
- For Integra DVD or MD players, you can control them by simply pointing the RC-418M controller directly at the component.

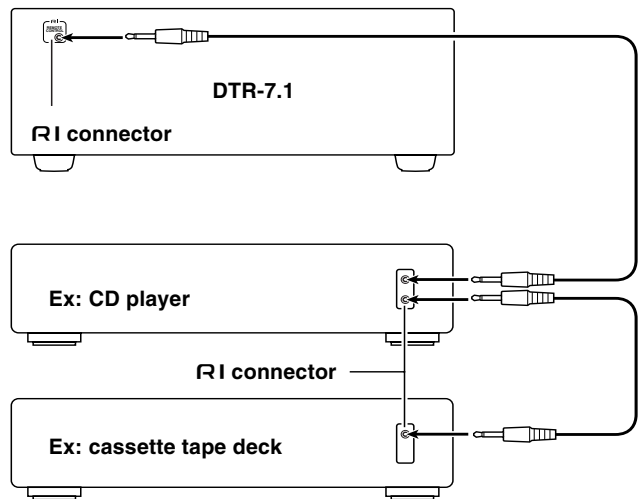

4 PRE OUT

These jacks are for connecting auxiliary power amplifier.

5 ANTENNA

These jacks are for connecting the FM indoor antenna and AM loop antenna that are supplied with the DTR-7.1.

6 IR IN MAIN/IR IN ZONE 2

If the DTR-7.1 is located inside a rack or cabinet that will not allow infrared beams to reach the IR sensor, you will need to connect a remote sensor to IR IN MAIN input to be able to use the remote controller. Then install the remote sensor in an unblocked location where you can easily point the remote controller.

To use the remote controller in the remote zone (Zone 2), which may be far separated from the DTR-7.1, connect a multiroom system kit to the IR IN MAIN/IR IN ZONE 2 input.

To be able to use the remote controller through either the IR IN MAIN or IR IN ZONE 2 inputs, you must connect one of the following (sold separately):

- Onkyo's Multi-Room System kits (IR Remote Controller Extension System), or
- Multiroom A/V distribution and control systems from Niles® and Xantech® to name a few

7 COMPONENT VIDEO INPUT/OUTPUT

If your DVD player or other device has component video connectors, be sure to connect them to these component video connectors on the DTR-7.1. The DTR-7.1 has two component video input connectors to obtain the color information (Y, Pb, Pr) directly from the recorded DVD signal or other video component and one component video output connector to output it directly into the matrix decoder of the display device. By sending the pure DVD component video signal directly, the DVD signal forgoes the extra processing that normally would degrade the image. The result is vastly increased image quality, with incredibly lifelike colors and crisp detail.

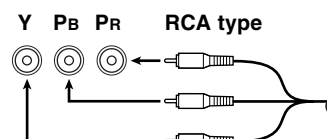

Rear panel facilities

8 SPEAKERS

6 terminals are provided for the front left, front right, front center, surround left, surround right, and surround back speakers. Speaker outputs are compatible with banana plug connectors (other than European models).

9 AC OUTLETS

The DTR-7.1 is supplied with AC mains outlets for connecting the power cords from other devices so that their power is supplied through the DTR-7.1. By doing this, you can use the STANDBY/ON button on the DTR-7.1 to turn on and off the connected devices as well.

Caution:

Make sure that the total capacity of the other components connected to this unit does not exceed the capacity that is printed on the rear panel.

For this model, the capacity is 120 watts.

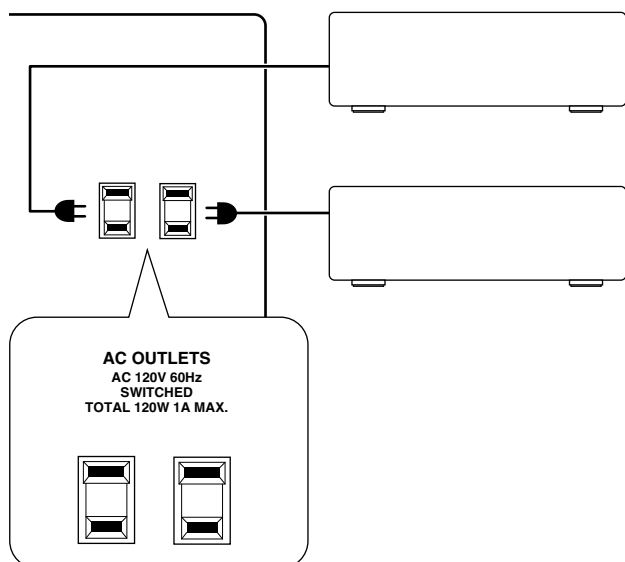

10 MULTI CHANNEL INPUT

By connecting a DVD player, MPEG decoder, or other component that has a multi channel port, you can playback the audio with 5.1 channel or 7.1 channel output. So, be sure to prepare a cable that can properly connect the DTR-7.1 to the peripheral device.

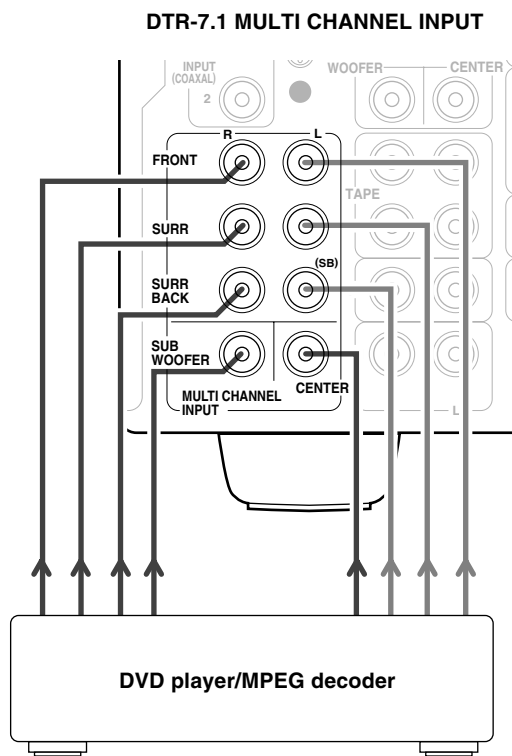

11 AUDIO IN/OUT

These are the analog audio inputs and outputs. There are 7 audio inputs (4 of which are linked to video inputs) and 3 audio outputs (2 of which is linked to a video output). The audio jacks are nominally labeled for cassette tape decks, compact disc players, turntables, and DVD players. To the audio jacks for VIDEO 1 to 3 connect the audio output from VCRs, LD players, and other video components. The audio inputs and outputs require RCA-type connectors.

- When connecting a VCR or other video component, make sure you connect the audio and video leads together (i.e., both to VIDEO 3).
- The DTR-7.1 is designed for use with turntables that use moving magnet cartridges.

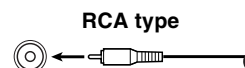

12 MONITOR OUT

The monitor output includes both composite video and S video configurations. This output is for connecting television monitors or projectors.

Rear panel facilities

13 VIDEO IN/OUT

These are the video inputs and outputs. On the rear panel, there are 4 video inputs and 2 video outputs and each one includes both composite video and S video configurations. Connect VCRs, LD players, DVD players, and other video components to the video inputs.

The 2 video output channels can be used to be connected to video tape recorders for making recordings.

- When connecting a VCR or other video component, make sure you connect the audio and video leads together (i.e., both to VIDEO 3).
- The VIDEO 4 inputs are located on the front panel.

Composite video jack



S video jack



14 12V TRIGGER A, B terminals

These terminals are provided so that you can use the operation of the DTR-7.1 control the operation of another externally connected device. Connect the component to this 1/8-inch mini-jack terminal and when the set input source is selected, the device will turn on. Set the 12V TRIGGER terminal using the 12V Trigger setting of the 12V Trigger sub-menu (see page 40).

15 ZONE 2

These are the audio output jacks for the remote zone (Zone 2). Use these outputs to connect the remote zone. For the connection procedure, refer to “Connecting to the remote zone (Zone 2) input” on page 24. These outputs are activated by the Zone 2 button on the front panel.

16 AC INLET

Plug the supplied power cord into this AC INLET and then into the power outlet on the wall.

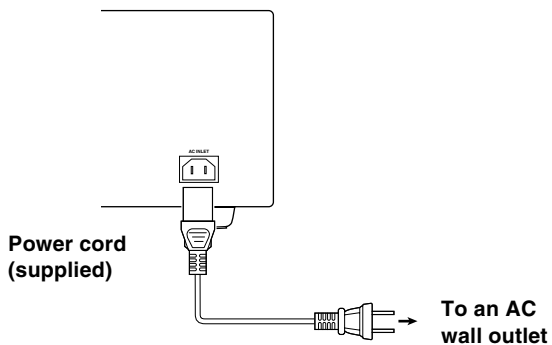

- Do not use a power cord other than the one supplied with the DTR-7.1. The power cord supplied is designed for use with the DTR-7.1 and should not be used with any other device.
- Never have the power cord disconnected from the DTR-7.1 while the other end is plugged into the wall outlet. Doing so may cause an electric shock. Always connect by plugging into the wall outlet last and disconnect by unplugging from the wall outlet first.

17 RS 232

The RS 232 port is to be used in conjunction with an external controller to control the operation of the DTR-7.1 by using an external device.

Example of how to connect your equipment

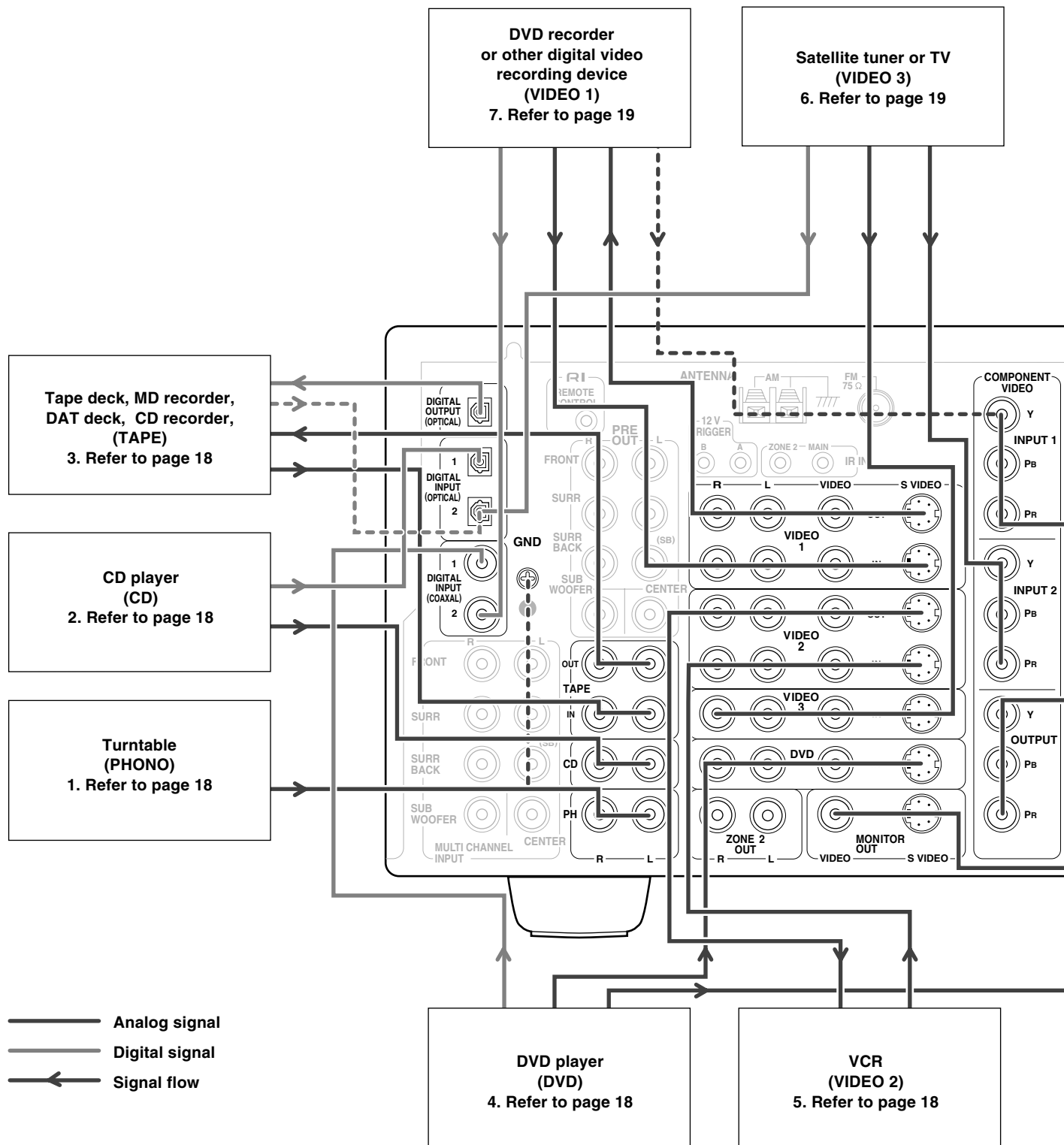

Example of how to connect your equipment

Standard connections

Here is explanation of how to connect the main components to the DTR-7.1 in the standard manner. There are many ways that any one component can be connected, and it is up to you to decide which method best fits your situation. The directions given here are only one option and should only be thought of as such. It is best to fully understand the nature of each connector and terminal as well as each of your components and their features to ascertain which method of connection is best.

- Be sure to always refer to the instruction manual that came with the component that you are connecting.
- Do not plug in the power cord until all connections have been made.
- For input jacks, red connectors (marked R) are used for the right channel, white connectors (marked L) are used for the left channel, and yellow connectors (marked V) are used for video connection.
- Insert all plugs and connectors securely. Improper connections can result in noise, poor performance, or damage to the equipment.
- Do not bind audio connection cables with power cords and speaker cables. Doing so may adversely affect the sound quality.

For a detailed explanation of how to connect the devices given below, refer to the pages listed.

Speakers: See page 20

Radio antenna: See page 22

Enjoying the DTR-7.1 from a remote room (Zone 2):

See page 24

Power amplifier: See page 26

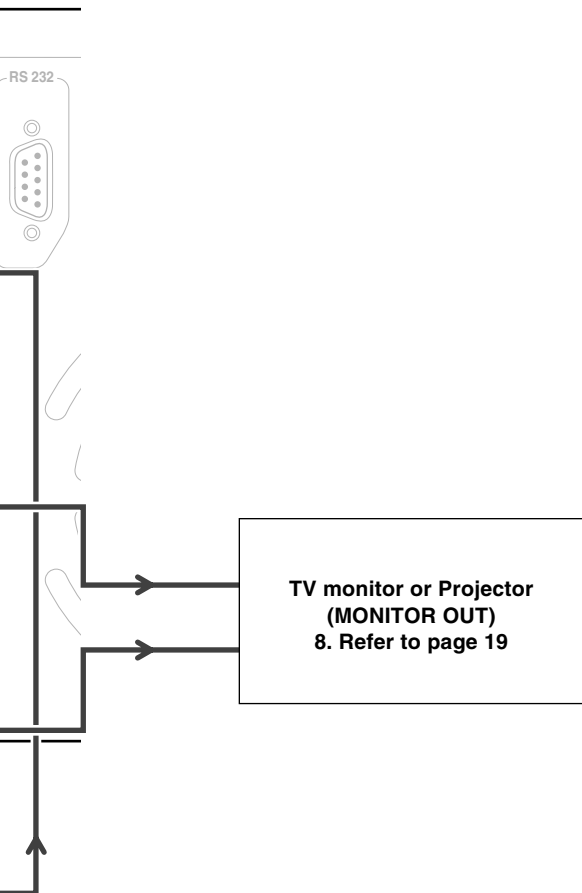

Default setting

Input source	Digital input	Component video
CD	OPTICAL 1	
PHONO	----	
FM		
AM		
TAPE	----	
DVD	COAXIAL 1	INPUT 1
VIDEO 1	COAXIAL 2	----
VIDEO 2	----	----
VIDEO 3	OPTICAL 2	INPUT 2
VIDEO 4	----	----

---- : No setting

 : Not applicable

Example of how to connect your equipment

Connecting your audio components

Below is an example of how you can connect your audio components to the DTR-7.1. Refer to the diagram on pages 16 and 17 for the following connection examples.

1. Connecting a turntable

Using an RCA-type audio connection cable, connect the output terminal on the turntable to the PHONO IN jacks on the DTR-7.1. Make sure that you properly connect the left channel to the L jack and the right channel to the R jack.

Note:

The DTR-7.1 is designed for use with moving magnet cartridges. For proper operation, connect a ground (or earth) wire to the GND terminal. For some turntables, however, connecting the ground wire may cause increased noise, and in such a case, a ground wire is not necessary and should not be connected.

2. Connecting a compact disc player

Using an RCA-type audio connection cable, connect the output terminal on the compact disc player to the CD IN jacks on the DTR-7.1. Make sure that you properly connect the left channel to the L jack and the right channel to the R jack.

If the compact disc player has a digital output jack as well, be sure to also connect it to either a DIGITAL INPUT (COAXIAL) or DIGITAL INPUT (OPTICAL) jack on the DTR-7.1 depending on the type of connector on the compact disc player.

With the initial settings of the DTR-7.1, the CD input source is set for digital input at the OPTICAL 1 jack. If the digital connection is made at a different jack, this must be changed at the OSD Menu: Input Setup → Audio Setup → Digital Input (see page 34).

3. Connecting a cassette tape deck, MD recorder, DAT deck, or CD recorder

Using an RCA-type audio connection cable, connect the output terminals (PLAY) of the device to the TAPE IN jacks on the DTR-7.1 and the input terminals (REC) to the TAPE OUT jacks. Make sure that you properly connect the left channel to the L jack and the right channel to the R jack.

If the device has a digital output jack as well, be sure to also connect it to either a DIGITAL INPUT (COAXIAL) or DIGITAL INPUT (OPTICAL) jack on the DTR-7.1 depending on the type of connector on the device.

If you connect the device to the DIGITAL INPUT terminal, then this input source must be set for digital input at the OSD Menu: Input Setup → Audio Setup → Digital Input.

If the device also has a digital input jack, it can be connected to the DIGITAL OUTPUT (OPTICAL) jack on the DTR-7.1 for digital recording of the source for REC OUT at the DTR-7.1.

Caution:

The output from the DIGITAL OUTPUT jack of the DTR-7.1 is only the digital signal input to the DIGITAL INPUT jack.

Connecting your video components

Below is an example of how you can connect your video components to the DTR-7.1. Refer to the diagram on pages 16 and 17 for the following connection examples.

The flow of the video signals is as follows:

- The signal that comes in from VIDEO IN is sent to VIDEO OUT.
- The signal that comes in from S VIDEO IN is sent to S VIDEO OUT
- The signal that comes in from COMPONENT VIDEO IN is sent to COMPONENT VIDEO OUT.

Caution:

If only the video connection for the MONITOR OUT is made, even if the input from each source component is through a component video connection, the picture will not appear. If only the S video connection for the MONITOR OUT is made, the picture will not appear.

4. Connecting a DVD player or LD player

Using an RCA-type video connection cable, connect the video output terminal (composite) on the device to the DVD VIDEO IN jack on the DTR-7.1. If there is an S video output terminal on the device, connect it to the DVD S VIDEO IN jack using an S video cable. If the device has component video outputs, connect them to one of the COMPONENT VIDEO INPUT jacks.

Using an RCA-type audio connection cable, connect the audio output terminal on the device to the audio DVD IN jacks on the DTR-7.1. Make sure that you properly connect the left channel to the L jack and the right channel to the R jack.

If the device has a digital output jack as well, be sure to also connect it to either a DIGITAL INPUT (COAXIAL) or DIGITAL INPUT (OPTICAL) jack on the DTR-7.1 depending on the type of connector on the DVD player.

With the initial settings of the DTR-7.1, the DVD input source is set for digital input at the COAXIAL 1 jack. If the digital connection is made at a different jack, this must be changed at the OSD Menu: Input Setup → Audio Setup → Digital Input (see page 34).

5. Connecting a video cassette recorder

Using an RCA-type video connection cable, connect the video output terminal (composite) on the video cassette recorder to the VIDEO 2 IN jacks on the DTR-7.1 and video input terminal to the VIDEO 2 OUT jacks. If there is an S video input/output terminal on the video cassette recorder, connect it to the S VIDEO 2 IN/OUT jack using an S video cable. If the video cassette recorder has component video outputs, connect them to one of the COMPONENT VIDEO INPUT jacks.

Using an RCA-type audio connection cable, connect the audio output terminal on the video cassette recorder to the same VIDEO 2 IN audio jacks on the DTR-7.1 and audio input terminal to the VIDEO 2 OUT audio jacks. Make sure that you properly connect the left channel to the L jack and the right channel to the R jack.

Example of how to connect your equipment

6. Connecting a satellite tuner or television

Using an RCA-type video connection cable, connect the video output terminal (composite) on the satellite tuner or television to the VIDEO 3 IN jacks on the DTR-7.1. If there is an S video output terminal on the satellite tuner or television, connect it to the S VIDEO 3 IN jack using an S video cable. If the satellite tuner or television has component video outputs, connect them to one of the COMPONENT VIDEO INPUT jacks.

Using an RCA-type audio connection cable, connect the audio output terminal on the satellite tuner or television to the same VIDEO 3 IN audio jacks on the DTR-7.1. Make sure that you properly connect the left channel to the L jack and the right channel to the R jack.

If the satellite tuner or television has a digital output jack as well, be sure to also connect it to either a DIGITAL INPUT (COAXIAL) or DIGITAL INPUT (OPTICAL) jack on the DTR-7.1 depending on the type of connector on the set top box or television.

With the initial settings of the DTR-7.1, the VIDEO 3 input source is set for digital input at the OPTICAL 2 jack. If the digital connection is made at a jack different from the initial settings, this must be changed at the OSD Menu: Input Setup → Audio Setup → Digital Input (see page 34).

7. Connecting a DVD recorder or other digital video recording device

Using an RCA-type video connection cable, connect the video output terminal (composite) on the device to the VIDEO 1 IN jacks on the DTR-7.1 and video input terminal to the VIDEO 1 OUT jacks. If there is an S video input/output terminal on the device, connect it to the S VIDEO 1 IN/OUT jack using an S video cable. If the device has component video outputs, connect them to one of the COMPONENT VIDEO INPUT jacks.

Using an RCA-type audio connection cable, connect the audio output terminal on the device to the same VIDEO 1 IN audio jacks on the DTR-7.1 and audio input terminal to the VIDEO 1 OUT audio jacks. Make sure that you properly connect the left channel to the L jack and the right channel to the R jack.

If the device has a digital output jack as well, be sure to also connect it to either a DIGITAL INPUT (COAXIAL) or DIGITAL INPUT (OPTICAL) jack on the DTR-7.1 depending on the type of connector on the device.

With the initial settings of the DTR-7.1, the VIDEO 1 input source is set for digital input at the COAXIAL 2 jack. If the digital connection is made at a different jack, this must be changed at the OSD Menu: Input Setup → Audio Setup → Digital Input (see page 34).

If the device also has a digital input jack, it can be connected to the DIGITAL OUTPUT (OPTICAL) jack on the DTR-7.1 for digital recording of the source for REC OUT at the DTR-7.1.

8. Connecting a television monitor or projector

Using an RCA-type video connection cable, connect the video input terminal (composite) on the monitor to one of the MONITOR OUT jacks on the DTR-7.1. If there is an S video input terminal on the monitor, connect it to the S VIDEO MONITOR OUT jack using an S video cable. If the device has component video inputs, connect them to the COMPONENT VIDEO OUTPUT jacks.

Caution:

Note that the OSD Menu will only be displayed on the monitor connected to MONITOR OUT and not those connected to the COMPONENT VIDEO OUTPUT jacks.

9. Connecting video camera or television game

Using an RCA-type video connection cable, connect the video output terminal (composite) on the device to the VIDEO 4 IN jacks on the DTR-7.1. If there is an S video output terminal on the device, connect it to the S VIDEO 4 VIDEO CAM INPUT jack using an S video cable.

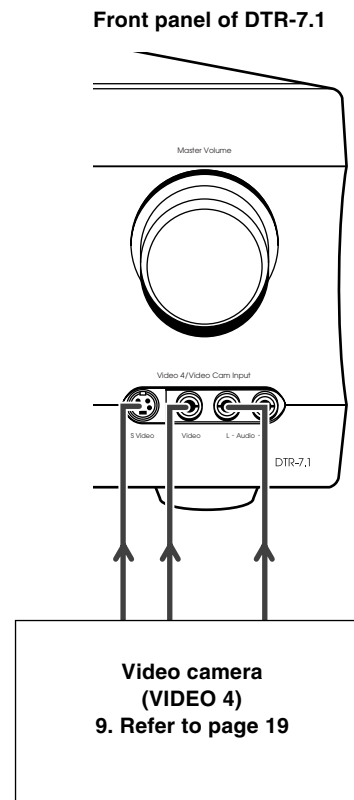

The VIDEO 4 INPUT jack is equipped with a protective cap. When using this jack, remove the protective cap and keep it safely. When not using this jack, replace the protective cap.

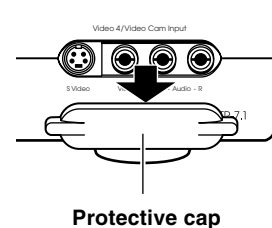

Connecting speakers

Before connecting the speakers, place them correctly by consulting the instruction manuals that came with them.

For surround playback, the configuration and placement of your speakers are very important.

For THX surround EX playback, we recommend that you use a THX speaker system that is certified by Lucasfilm Ltd.

Ideal speaker configuration

- **Front right and left speakers**
- **Center speaker**
Produces a rich sound image by serving as a sound source for the front right and left speakers and enhancing the sonic movement.
- **Surround right and left speakers**
Adds three-dimensional sonic movement and produces environmental sound associated with the background and effect sound for each scene.
- **Surround back speaker**
Required for enjoying THX Surround EX audio. For audio using surround back right and surround back left speakers, a separately-sold 2-channel power amplifier is required.
- **Subwoofer**
Produces powerful and heavy bass.

Minimum speaker configuration for surround sound playback

- **Front right and left speakers**
- **Surround right and left speakers**

The sound recorded for the center speaker and the subwoofer will be properly distributed to the front right and left speakers for optimized surround playback.

Speaker placement

Ideal speaker placement varies depending on the size of your room and the wall coverings. Here, only typical example of speaker placement and recommendations are shown.

Important points regarding speaker placement

Front left and right speakers and center speaker

- Place these three speakers at the same height from the floor.
- Place each speaker so that sound is aimed at the location of the listener's ears when at the listening position.

Surround left and right speakers

- Place these speakers so that their height is 3.3 feet (1 meter) higher than that of the listener's ears.

Surround back speaker/Surround back left and right speakers

- Surround back speaker is required for enjoying THX Surround EX audio.
- Place these speakers behind the listener so that the angle between each speaker and the listener is approximately 30 degrees.
- Place these speakers so that their height is 3.3 feet (1 meter) higher than that of the listener's ears.

(Only one surround back speaker)

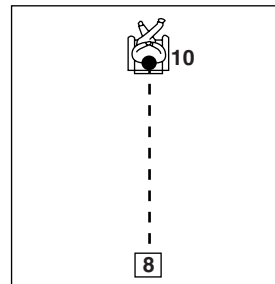

(Two surround back speakers)

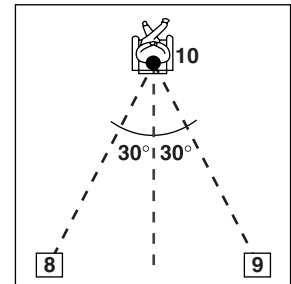

Subwoofer

A subwoofer is recommended for the highest bass effect.

(Only one surround back speaker)

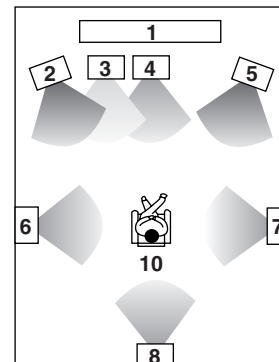

(Two surround back speakers)

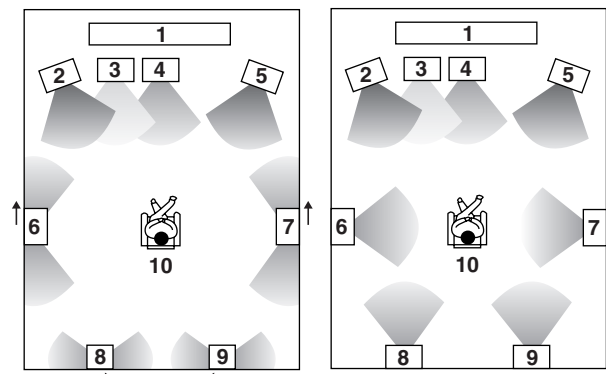

- | | |
|-----------------------|---|
| 1 TV or screen | 6 Surround left speaker |
| 2 Front left speaker | 7 Surround right speaker |
| 3 Subwoofer | 8 Surround back left speaker or Surround back speaker |
| 4 Center speaker | 9 Surround back right speaker |
| 5 Front right speaker | 10 Listening position |

Most dipoles have an arrow on them to indicate their orientation towards the screen. So for the side dipoles, the arrows point forward. For the back dipoles, the arrows should point towards each other to achieve the correct acoustical phasing in the room.

Connecting speakers

Connecting speakers

Notes:

- The DTR-7.1 is designed to produce optimum sound quality when speakers with impedances within the specified ranges are connected. Check the following information and choose speakers with appropriate impedances for the connections.

CAUTION:

SPEAKER IMPEDANCE

6 min. per each speaker terminal.

- When you are using only one speaker or when you wish to listen to monaural (mono) sound, a single speaker should never be connected in parallel to both the right and left-channel terminals simultaneously.

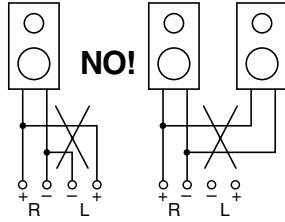

- To prevent damage to circuitry, never short-circuit the positive (+) and negative (-) speaker wire.



- Be sure to connect the positive and negative cables for the speakers properly. If they are mixed up, the left and right signals will be reversed and the audio will sound unnatural.
- Connect speakers with an impedance between 6 and 16 . Connecting speakers with an impedance less that 6 may damage the DTR-7.1.
- Do not connect more than one speaker cable to one speaker terminal. Doing so may damage the DTR-7.1.

Connecting the speaker cable

- Strip away 5/8 in. of wire insulation.
- Twist wire ends very tight.
- Unscrew
- Insert wire
- Screw

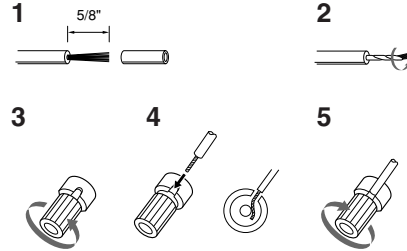

Connecting a subwoofer

Use the PRE OUT SUBWOOFER jack to connect a subwoofer with a built-in power amplifier. If your subwoofer does not have a built-in amplifier, connect an amplifier to the PRE OUT SUBWOOFER jack and the subwoofer to the amplifier.

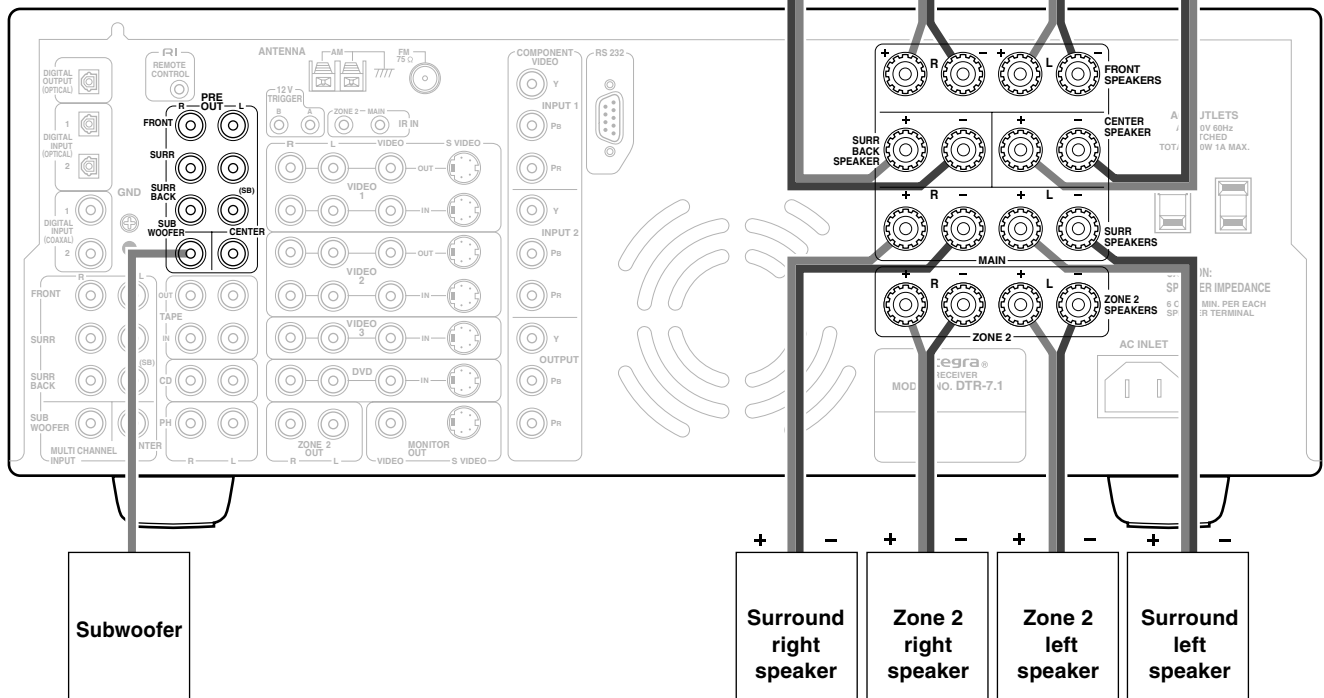

Connecting antennas

To use the tuner of DTR-7.1, it is necessary to prepare the supplied FM and AM antennas.

- Adjustment and placement of the FM and AM antennas for better reception must be done while listening to a station broadcast.
- If better reception cannot be obtained, then placement of an outside antenna is recommended.

Assembling the AM loop antenna

Assemble the loop antenna as shown in the illustration.

- Refer to the next page for details on connecting the AM loop antenna.

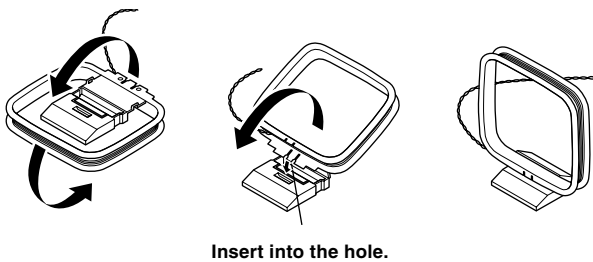

Connecting the AM antenna cable

1. Press down the lever.
2. Insert the wire into the hole.
3. Release the lever.

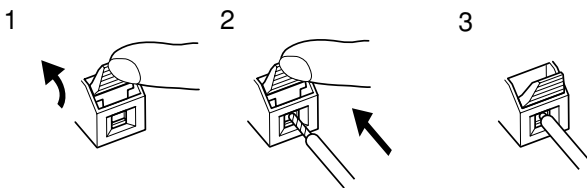

Connecting the included antennas

Connecting the FM indoor antenna:

The FM indoor antenna is for indoor use only. During use, extend the antenna and move it in various directions until the clearest signal is received. Fix it with push pins or similar implements in the position that will cause the least amount of distortion.

If the reception is not very clear with the attached FM indoor antenna, the use of an outdoor antenna is recommended.

Connecting the AM loop antenna:

The AM loop antenna is for indoor use only. Set it in the direction and position where you receive the clearest sound. Put it as far away as possible from the DTR-7.1, televisions, speaker cables, and power cords.

When reception is not satisfactory with the attached AM loop antenna alone, connection of an outdoor antenna is recommended.

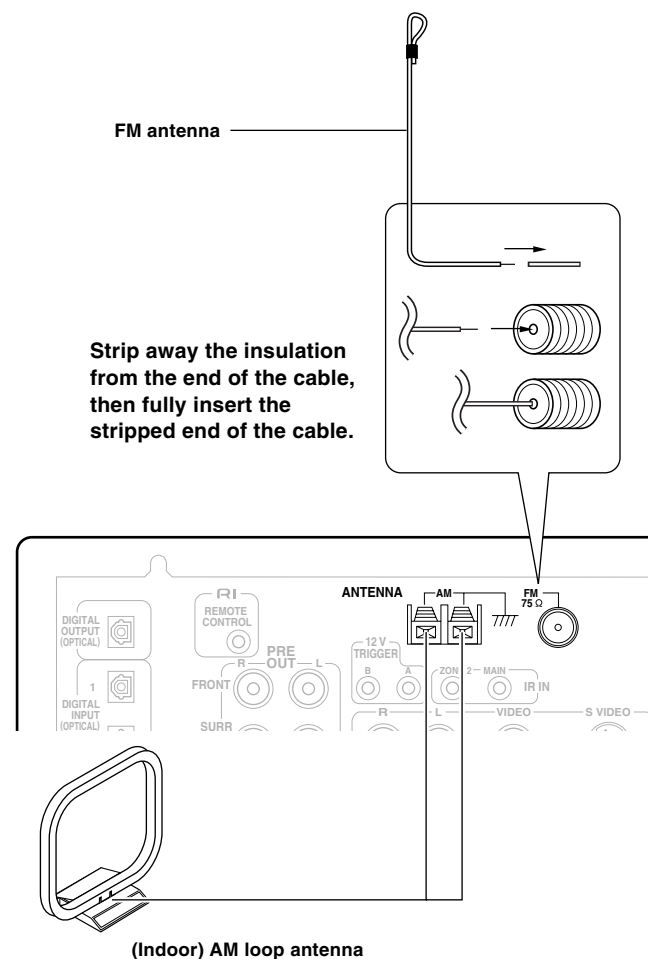

Hint:

Either of the split ends of the AM antenna can be connected to either terminal. Unlike speaker cabling, there is no polarity for AM broadcast signals.

Connecting antennas

Connecting an FM outdoor antenna

Please make sure that you follow the considerations:

- Keep the antenna away from noise sources (neon signs, busy roads, etc.).
- It is dangerous to put the antenna close to power lines. Keep it well away from power lines, transformers, etc.
- To avoid the risk of lightning and electrical shock, grounding is necessary. Follow item 14 of the "Important Safeguards" on page 2 when you install the outdoor antenna.

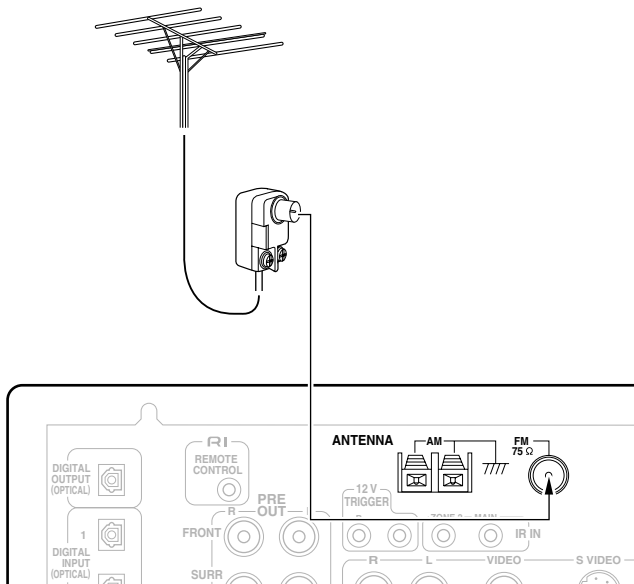

Directional linkage

Do not use the same antenna for both FM and TV (or VCR) reception since the FM and TV (or VCR) signals can interfere with each other. If you must use a common FM/TV (or VCR) antenna, use a directional linkage type splitter.

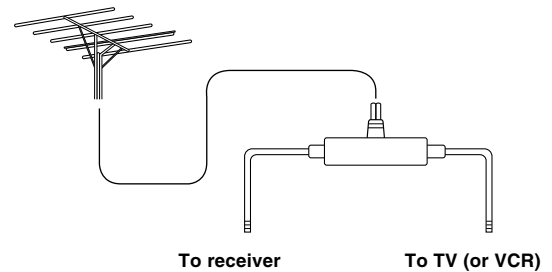

Connecting an AM outdoor antenna

An outdoor antenna will be more effective if it is stretched horizontally above a window or outside.

- Do not remove the AM loop antenna.
- To avoid the risk of lightning and electrical shock, grounding is necessary. Follow item 14 of the "Important Safeguards" on page 2 when you install the outdoor antenna.

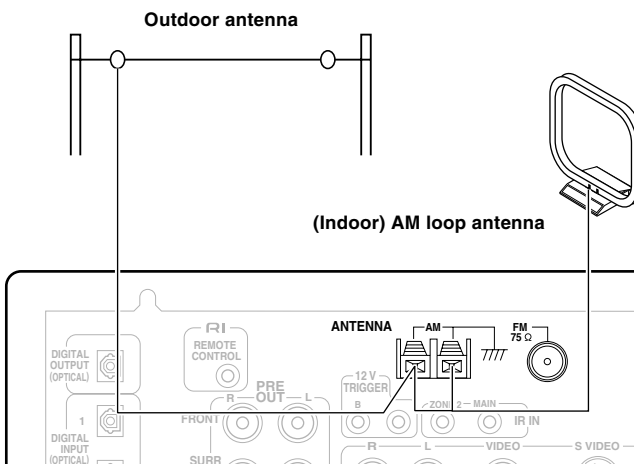

Connecting to the remote zone (Zone 2) input

Outline

The IR IN ZONE 2 input allows you to control the DTR-7.1 from the remote zone (Zone 2) with the remote controller even though the remote zone is physically separated. The diagram below shows how to make the proper connections for the remote zone.

The following equipment (sold separately) is essential for operation from the remote zone:

- Onkyo's Multi-Room System kits (IR Remote Controller Extension System), or
- Multiroom A/V distribution and control systems from Niles® and Xantech® to name a few

Make connection as shown below. Do not plug the equipment into the power source until the connection is complete.

When using the ZONE 2 SPEAKERS terminals

1. Connect the speaker cables from the speakers in the remote zone (Zone 2) speaker terminals on the DTR-7.1.
2. Install the connecting block in the main zone and connect it to the IR IN ZONE 2 input at the DTR-7.1.
3. Install the remote sensor in the remote zone and connect it to the connecting block in the main zone.

Connection example for Onkyo's Multi-room System kit

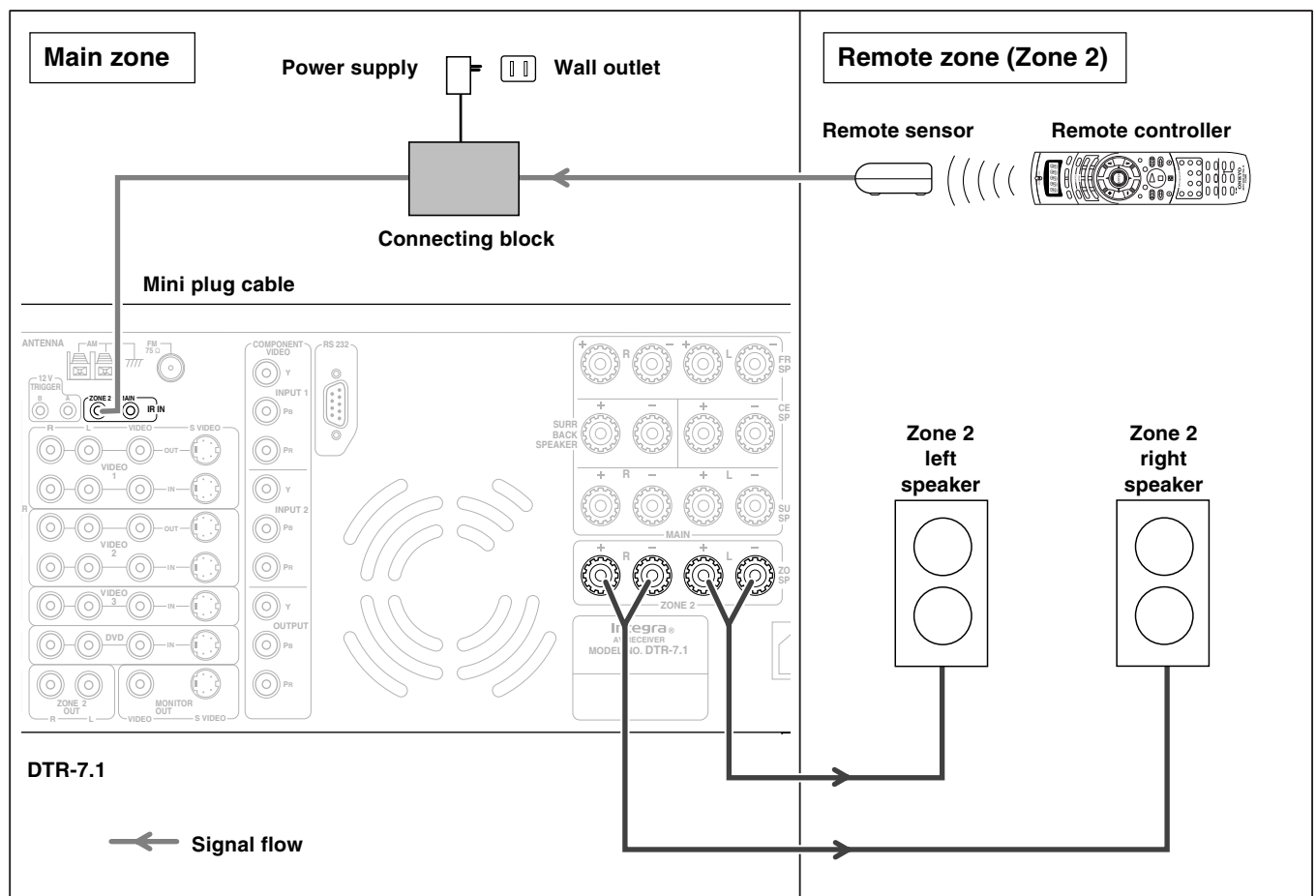

Connecting to the remote zone (Zone 2) input

When using the ZONE 2 OUT terminals

The ZONE 2 OUT terminal is a constant output. Connect to the LINE input of the amplifier (CD, tape, etc.). Adjust the volume with the amplifier connected to the ZONE 2 OUT terminal.

1. Connect the DTR-7.1 to the amplifier for the remote zone.

2. Connect the remot zone speaker cables to the speaker terminals on the amplifier.
3. Install the connecting block in the main zone and connect it to the IR IN ZONE 2 input at the DTR-7.1.
4. Install the remote sensor in the remote zone and connect it to the connecting block in the main zone.

Connection example for Onkyo's Multi-room System kit

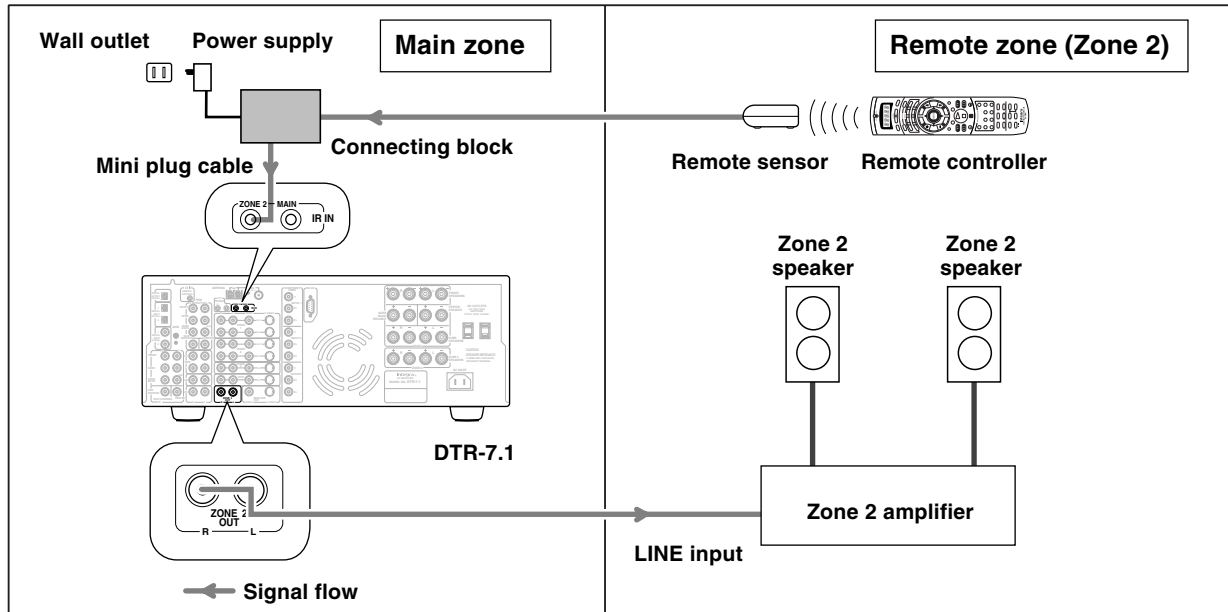

Connecting to the IR IN MAIN input

Outline

If the DTR-7.1 is located inside a cabinet or other enclosure where the infrared beams from the remote controller cannot enter, then operation with the remote controller will not be possible. In such a case, it will be necessary to install a remote sensor at a location outside of the cabinet for the infrared beams from the controller to reach.

1. Connect the connecting block to the IR IN MAIN input at the DTR-7.1.
2. Install the remote sensor at a location where it can detect the infrared beams from the remote controller.
3. Connect the remote sensor to the connecting block.

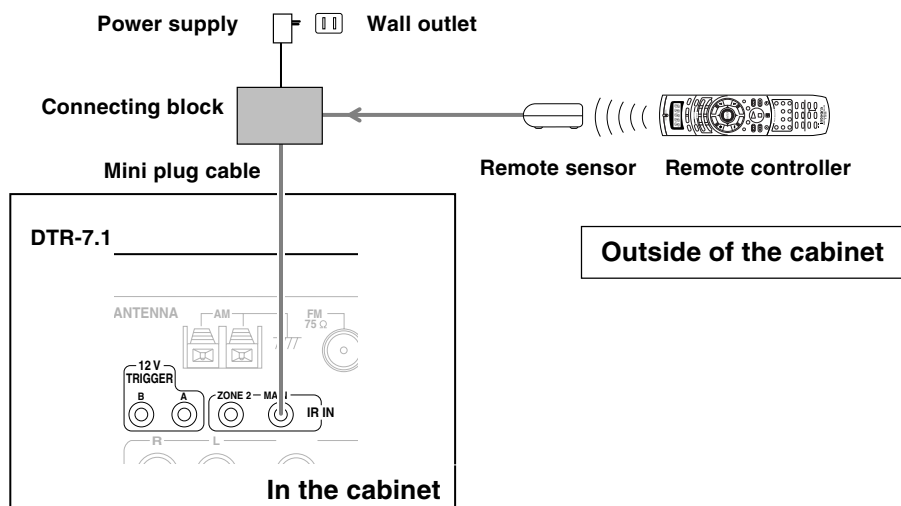

Connecting power amplifiers and two surround back speakers

Connecting power amplifiers

Using auxiliary power amplifiers allows you to listen at louder volumes than with the DTR-7.1 alone. If power amplifiers are used, connect each speaker to the corresponding power amplifier.

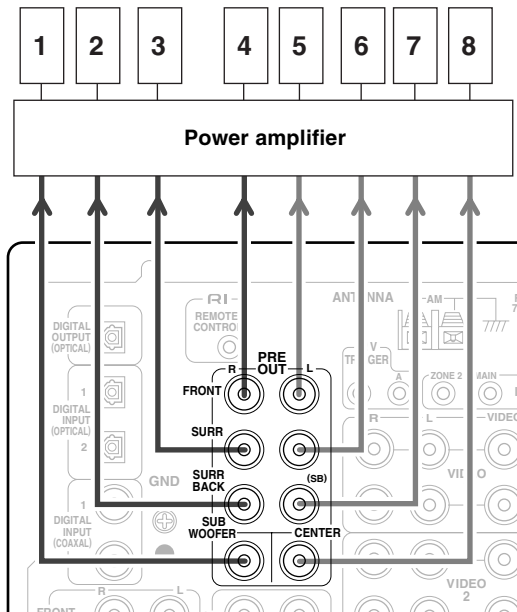

- | | |
|-------------------------------|------------------------------|
| 1 Subwoofer | 6 Surround left speaker |
| 2 Surround back right speaker | 7 Surround back left speaker |
| 3 Surround right speaker | 8 Center speaker |
| 4 Front right speaker | |
| 5 Front left speaker | |

Connecting two surround back speakers

To connect two surround back speakers, connect a power amplifier to the PRE OUT SURR BACK terminals on the DTR-7.1, and connect the surround back speakers to that power amplifier. You will also need to make the appropriate setting in the OSD Menu: Speaker Setup → Speaker Config → Surr Back Out (see page 30).

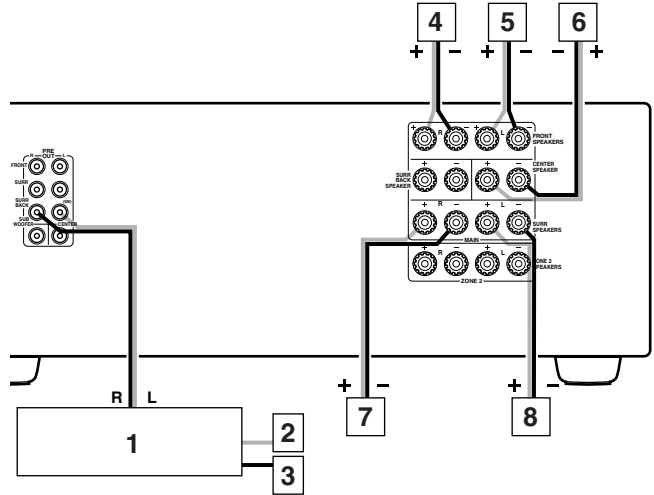

- | | |
|-------------------------------|--------------------------|
| 1 Power amplifier | 6 Center speaker |
| 2 Surround back left speaker | 7 Surround right speaker |
| 3 Surround back right speaker | 8 Surround left speaker |
| 4 Front right speaker | |
| 5 Front left speaker | |

Connecting the power

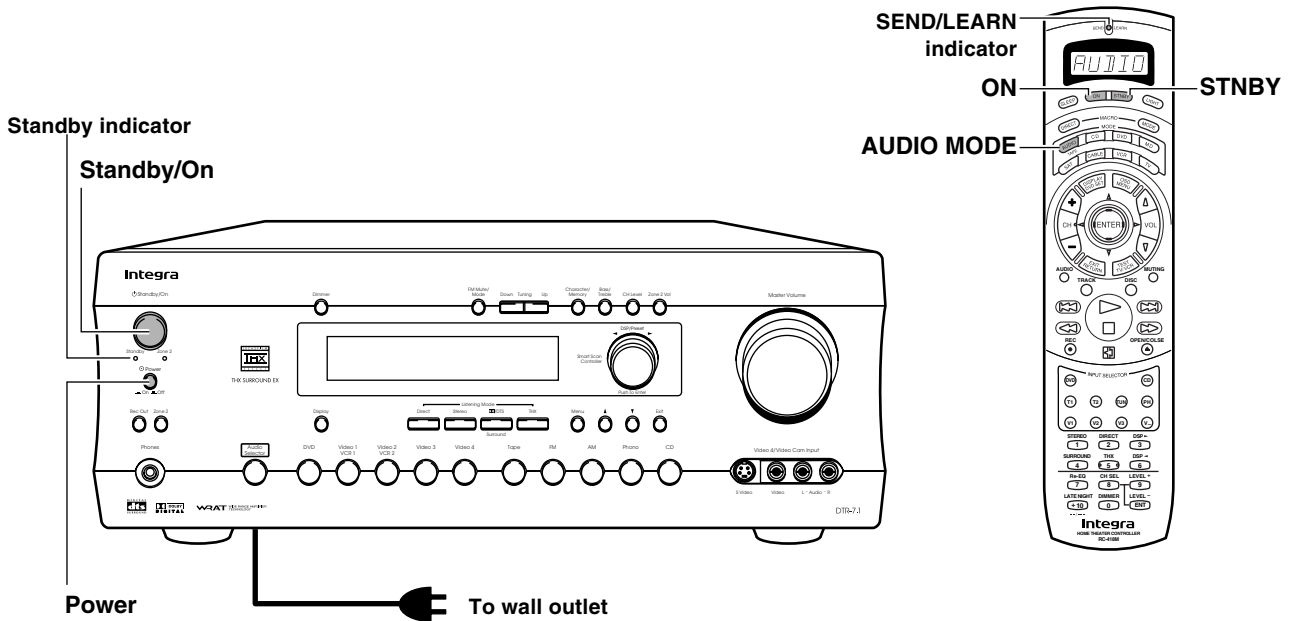

Connecting the power

- The DTR-7.1 is shipped with the main power (Power) switch in the on position (ON). When the power cord is plugged in for the first time, the DTR-7.1 will automatically enter the standby state and the Standby indicator will light (same condition after step 2 below).
- Before you plug in the DTR-7.1, confirm that all connections have been made properly.
- Turning on the power may cause a momentary power surge, which might interfere with other electrical equipment on the same circuit, such as computers. If this happens, use a wall outlet on a different circuit.

1. Plug the power cord into an AC wall outlet.

2. Press the Power switch to set the DTR-7.1 to standby state.

The Standby indicator will light up.

3. Press the Standby/On button to turn on the DTR-7.1. The display will light up and the Standby indicator will turn off.

If you press the Standby/On button again, the receiver returns to Standby mode.

Turning the power on from the remote controller:

Before you can use the remote controller, you must perform steps 1 and 2 above and place the DTR-7.1 in the standby state.

1. Press the AUDIO MODE button.

2. Press the ON button to turn on the DTR-7.1 (take it out of the standby state).

- To return the DTR-7.1 to the standby state, press the STNBY button.

Memory preservation

This unit does not require memory preservation batteries. A built-in memory power backup system preserves the contents of the memory during power failures and even when the Power switch is set to off. The Power switch must be set to on in order to charge the backup system.

The memory preservation period after the unit has been turned off varies depending on climate and placement of the unit. On the average, memory contents are protected over a period of a few weeks after the last time the unit has been turned off. This period is shorter when the unit is exposed to a highly humid climate.

The On-Screen Display (OSD) menu

The OSD menu is a settings menu that is displayed on your TV monitor and allows you to perform your speaker settings, setup your input sources, set the listening modes, and much more. In most situations, you will only need to set this once during the installation and layout of your home theater, and it rarely needs to be changed later.

The OSD menu consists of a main screen that is divided up into 5 menus: Speaker Setup, Input Setup, Listening Mode Setup, Preference, and OSD Setup. These menus are then divided up into various sub-menus, and these contain settings for you to optimize your home theater as you wish.

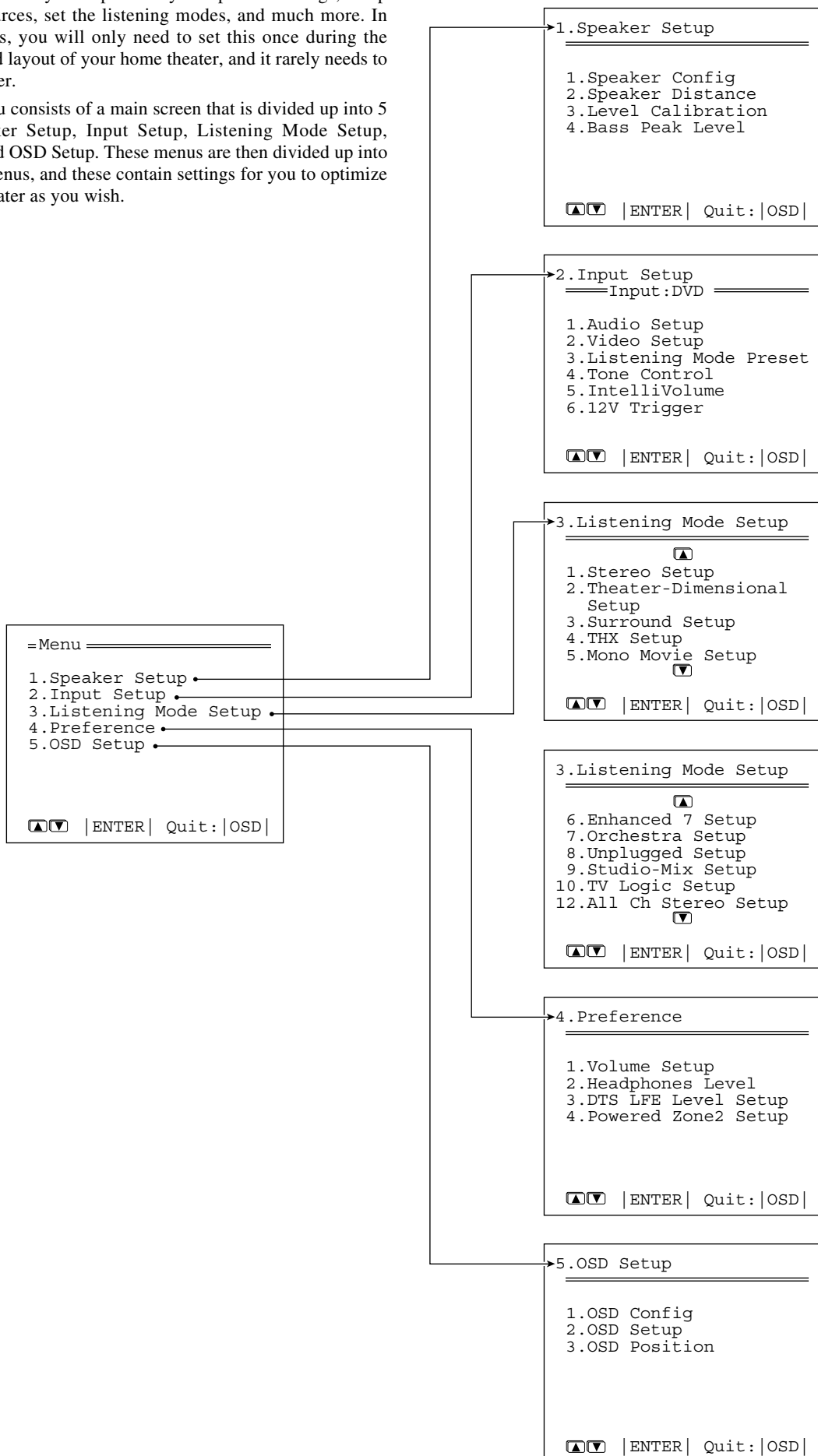

The On-Screen Display (OSD) menu

OSD

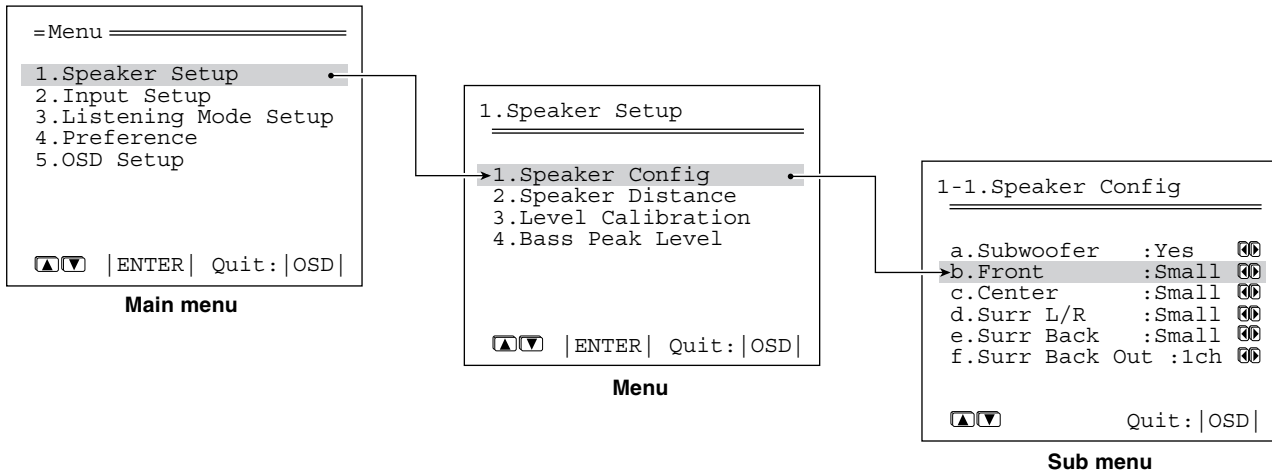

Navigating through the OSD menu

The explanations here assume you are using the buttons on the DTR-7.1 when entering the OSD menu. However, you can use the buttons on the remote controller as well. In addition to the display of the OSD Menu on your television monitor, the corresponding menu will also be displayed in the front display on the DTR-7.1.

The buttons on the remote controller correspond to those on the DTR-7.1 as shown below.

Button on remote controller	Button on DTR-7.1
OSD/MENU	Menu
(upper edge of ENTER button)	UP
(lower edge of ENTER button)	DOWN
(left edge of ENTER button)	(turn the SSC dial to the left)
(right edge of ENTER button)	(turn the SSC dial to the right)
ENTER	(press the SSC dial)
EXIT/RETURN	Exit

1. Press the MENU button.

The main menu screen of the OSD menu appears on your TV monitor.

2. Using the ▲ and ▼ cursor buttons, select the menu that you want to enter.

3. Press the ENTER button to enter the selected menu.

The screen for that menu appears.

4. Using the ▲ and ▼ cursor buttons, select the sub-menu that you want to enter, and press the ENTER button.

Each sub-menu has different settings that can be changed as desired, and they are all explained below. To change a setting, first select it using the ▲ and ▼ cursor buttons, and then change the setting using the ◀ and ▶ cursor buttons.

5. Press the EXIT button to set the new settings and return to the previous menu screen, and again to return to the main screen.

Note:

Press the MENU button to exit the OSD menu immediately.

If the OSD Menu does not appear

If the monitor is connected to MONITOR OUT (VIDEO) of the DTR-7.1, then perform the operations given below and set the OSD output to "Video." (The initial setting is "S Video.")

1. Press the Menu button.

"1. Speaker Setup" appears in the front display.

2. Turn the SSC dial to the right to display "5. OSD Setup" and press the SSC dial.

"OSD Config?" appears.

3. Press the SSC dial.

"OSD Out: S Video" appears.

4. Turn the SSC dial to the right to display "OSD Out: Video."

The OSD output changes to "Video."

Speaker Setup

1. Speaker Setup menu

After you have installed the DTR-7.1, connected all the components, and determined the speaker layout, it is now time to perform the settings in the Speaker Setup menu for the optimum sound acoustics for your environment and speaker layout.

Before you perform the following settings, it is important that you first determine the following characteristics:

- The types and sizes of the speakers that are connected.
- The distance from each speaker to your normal listening position.

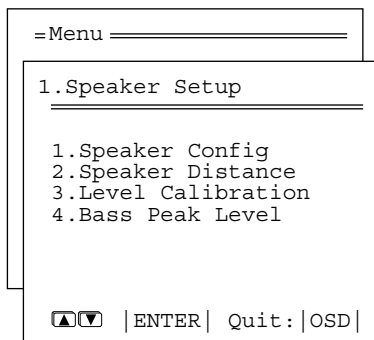

Memo:

(Only one surround back speaker)

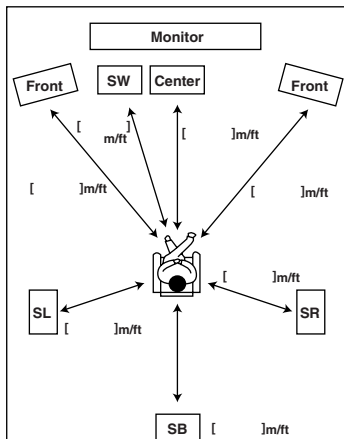

(Two surround back speakers)

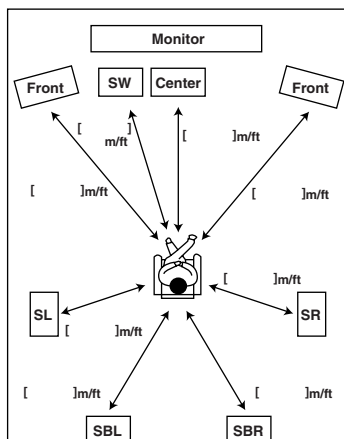

Tip:

When setting the speaker size in the Speaker Config sub-menu, use the guidelines given below.

Large: The complete frequency range for the channel you are setting will be output from the speaker.

Small: Frequencies of the channel you are setting lower than 80 Hz will be output from the subwoofer. If the front speakers are set to "Large," then the sound may be output from both the left and right speakers. (Set all speakers for THX speaker systems to "small.")

1-1. Speaker Config sub-menu

Here you will enter which speakers are connected and the size of each speaker.

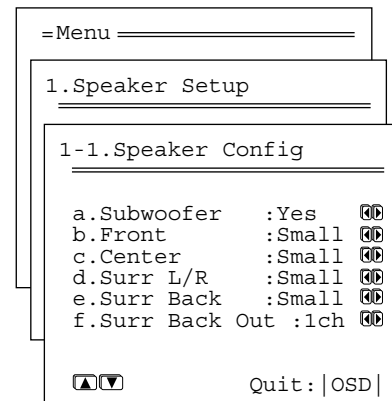

a. Subwoofer

Yes: Select when a subwoofer is connected.

No: Select when a subwoofer is not connected.

b. Front

Large: Select if the front speakers are large sized.

Small: Select if the front speakers are small sized.

- If "No" is selected for the Subwoofer setting, then this setting is fixed to "Large."

c. Center

None: Select if no center speaker is connected.

Large: Select if the center speaker is large sized.

Small: Select if the center speaker is small sized.

- If "Small" is selected for the Front setting, then "Large" cannot be selected for this setting.

d. Surr L/R

None: Select if no surround left and right speakers are connected.

Large: Select if the surround left and right speakers are large sized.

Small: Select if the surround left and right speakers are small sized.

- If "Small" is selected for the Front setting, then "Large" cannot be selected for this setting.

e. Surr Back

None: Select if no surround back left and right speakers are connected.

Large: Select if the surround back left and right speakers are large sized.

Small: Select if the surround back left and right speakers are small sized.

- If "None" is selected for the Surround L/R setting, then this setting is fixed to "None." (The display also disappears from the screen.)
- If "Small" is selected for the Surround L/R setting, then "Large" cannot be selected for this setting.

f. Surr Back Out

1ch: Select if there is only one surround back speaker.

2ch (Preout Only): Select if there are two surround back speakers. (For preout output only.)

Speaker Setup

1-2. Speaker Distance sub-menu

Here you will enter the distance from each speaker to your normal listening position (Loudspeaker Position Time Synchronization*). This is important for the timing of the acoustics to create the proper sound space that the DTR-7.1 and today's sound systems are able to produce.

Note:

Speakers that you selected "No" or "None" for in the Speaker Config sub-menu will not appear.

(Only one surround back speaker)

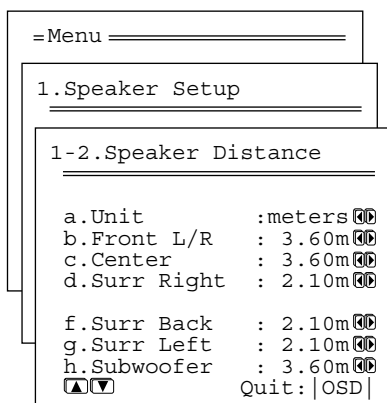

(Two surround back speakers)

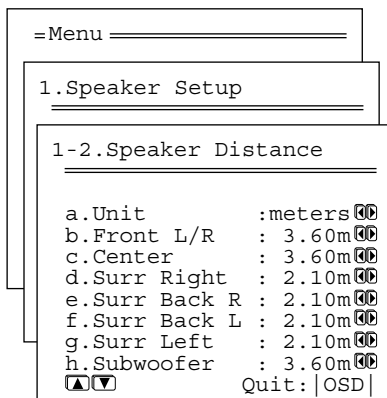

a. Unit

feet: Select if you will enter the distances in feet.

meters: Select if you will enter the distances in meters.

b. Front L/R

Set the distance from the front left and right speakers to your normal listening position between 1 and 30 feet in 0.5-foot intervals (0.3 to 9 meters in 0.15-meter intervals).

Position the front left and right speakers so that they are the same distance from the listener. If they are not, you may lose the center position for stereo sound.

c. Center

Set the distance from the center speaker to your normal listening position between 1 and 30 feet in 0.5-foot intervals (0.3 to 9 meters in 0.15-meter intervals).

d. Surr Right

Set the distance from the surround right speaker to your normal listening position between 1 and 30 feet in 0.5-foot intervals (0.3 to 9 meters in 0.15-meter intervals).

e. Surr Back R

Set the distance from the surround back right speaker to your normal listening position between 1 and 30 feet in 0.5-foot intervals (0.3 to 9 meters in 0.15-meter intervals).

- This setting appears if set for two surround back speakers in the Speaker Config sub-menu.

f. Surr Back L

Set the distance from the surround back left speaker to your normal listening position between 1 and 30 feet in 0.5-foot intervals (0.3 to 9 meters in 0.15-meter intervals).

- This setting appears if set for two surround back speakers in the Speaker Config sub-menu.

Note:

For audio using surround back right and surround back left speakers, a separately-sold 2-channel power amplifier is required.

f. Surr Back

Set the distance from the surround back speaker to your normal listening position between 1 and 30 feet in 0.5-foot intervals (0.3 to 9 meters in 0.15-meter intervals).

- This setting appears if set for one surround back speaker in the Speaker Config sub-menu.

g. Surr Left

Set the distance from the surround left speaker to your normal listening position between 1 and 30 feet in 0.5-foot intervals (0.3 to 9 meters in 0.15-meter intervals).

h. Subwoofer

Set the distance from the subwoofer to your normal listening position between 1 and 30 feet in 0.5-foot intervals (0.3 to 9 meters in 0.15-meter intervals).

* Loudspeaker Position Time Synchronization is a registered trademark of Lucasfilm Ltd.

Speaker Setup

1-3. Level Calibration sub-menu

Here you will set the volume for each speaker so that they are all heard by the listener at the same level. This is especially important for speaker layouts where the left and right speakers are at different distances or in asymmetrical positions due to room designs and configurations. These settings and the distance settings performed above are vital to create the proper acoustics required for the optimum sound space and dynamics.

Note:

The speaker level settings here are not effective for multi-channel input sources. To adjust the speaker levels for multi-channel input sources, you will need to use the CH SEL, LEVEL+, and LEVEL- buttons on the RC-418M remote controller. See page 57.

(Only one surround back speaker)

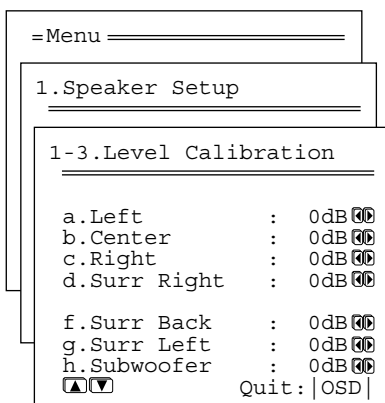

(Two surround back speakers)

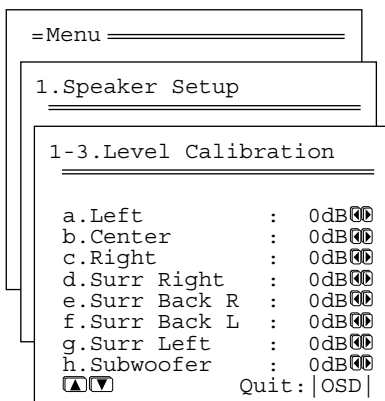

Calibrating the speaker levels

- (1) When this sub-menu is entered, the DTR-7.1 will emit a pink noise from the front left speaker. At this time, the Master volume automatically increases to the reference level (0dB). Remember the level of this noise and then press the ▼ cursor button. (Note that this can be adjusted to any level between -12 and 12 decibels in 1-decibel intervals.) The DTR-7.1 will now emit the pink noise from the center speaker.
- (2) Using the ◀ and ▶ cursor buttons, adjust the volume level of the noise from the center speaker so that it is the same level as the front left speaker. You can jog back and forth between the speakers to help you compare the volume levels.

- (3) Press the ▼ cursor button again. The DTR-7.1 will now emit the pink noise from the front right speaker.
- (4) Repeat steps (2) and (3) above for the front right and other speakers until all speakers are adjusted to the same volume level.

Notes:

- Speakers that you selected “No” or “None” for in the Speaker Config sub-menu will not appear.
- To accurately set the output levels, it is recommended to use a handheld sound pressure level (SPL) meter. Set the meter to C-weighting and slow averaging. A Radio Shack® SPL meter or equivalent is recommended. Using the internal channel noise generators, set each channel so that you read a 75 decibel sound pressure level.

a. Left

Sound comes from the front left speaker. Adjust the sound level between -12 and 12 decibels in 1-decibel intervals.

b. Center

Sound comes from the center speaker. Adjust the sound level between -12 and 12 decibels in 1-decibel intervals.

c. Right

Sound comes from the front right speaker. Adjust the sound level between -12 and 12 decibels in 1-decibel intervals.

d. Surr Right

Sound comes from the surround right speaker. Adjust the sound level between -12 and 12 decibels in 1-decibel intervals.

e. Surr Back R

Sound comes from the surround back right speaker. Adjust the sound level between -12 and 12 decibels in 1-decibel intervals.

- This setting appears if set for two surround back speakers in the Speaker Config sub-menu.

f. Surr Back L

Sound comes from the surround back (left) speaker. Adjust the sound level between -12 and 12 decibels in 1-decibel intervals.

- This setting appears if set for two surround back speakers in the Speaker Config sub-menu.

f. Surr Back

Sound comes from the surround back speaker. Adjust the sound level between -12 and 12 decibels in 1-decibel intervals.

- This setting appears if set for one surround back speaker in the Speaker Config sub-menu.

Note:

For audio using surround back right and surround back left speakers, a separately-sold 2-channel power amplifier is required.

g. Surr Left

Sound comes from the surround left speaker. Adjust the sound level between -12 and 12 decibels in 1-decibel intervals.

h. Subwoofer

Sound comes from the subwoofer. Adjust the sound level between -15 and 12 decibels in 1-decibel intervals.

Speaker Setup

1-4. Bass Peak Level (Bass Peak Level Manager*) sub-menu

Setting the bass peak level is important to keep your subwoofer from being damaged by preventing it from outputting over a set volume. If your subwoofer has a built-in limiter, set this setting to “Off.”

Note:

If your system does not include a subwoofer, this setting will set the bass peak level for your front speakers.

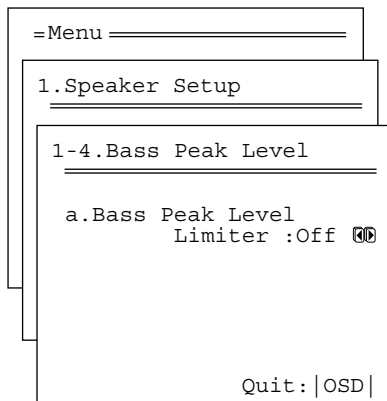

a. Bass Peak Level Limiter

On: Select to set the bass peak level. When “On” is selected, the Peak Level setting appears below.

Off: Select to turn off the bass peak level limiting function.

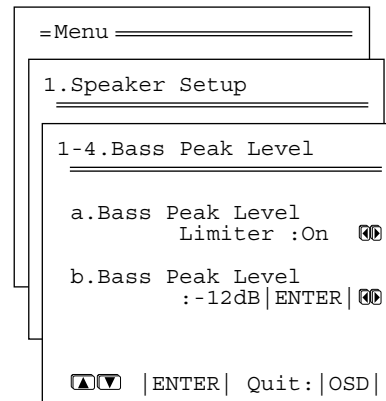

b. Bass Peak Level

The current bass peak level is displayed. Press the ENTER button (or the SSC dial) to output a test sound. Then press the ► cursor button (or turn the SSC dial) to slowly raise the volume to the point where the sound becomes distorted and then back it off until it returns to normal. This is the proper setting for the bass peak level. After setting the Peak Level at the Bass Peak Level sub-menu, press the EXIT button. The values are set and the previous screen appears.

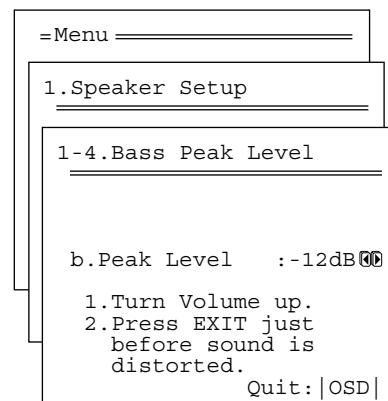

Note:

- The volume can be adjusted to either – or between –61 to +18 decibels in 1-decibel increments.
- Do not allow the distorted sound to be output from the subwoofer for a long time for it may damage the subwoofer.

* Bass Peak Level Manager is a registered trademark of Lucasfilm Ltd.

Input Setup

2. Input Setup menu

This menu allows you to setup the various input sources available with the DTR-7.1. Each input source may have a great number of settings that are difficult to keep track of, so we recommend making a chart to record what you have set and for which component to prevent confusion later.

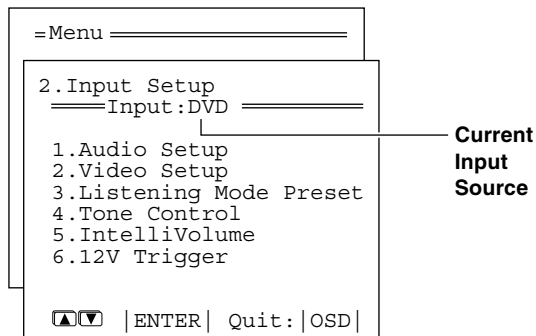

2-1. Audio Setup sub-menu

The settings made in this sub-menu are valid for the input source that is currently selected with the input source buttons at the front panel and, therefore, these settings are made separately for each digital input source. This sub-menu will not appear if the selected input source button is AM or FM. If this setting is incorrectly made, the digital audio signals may not be properly output, or not heard at all.

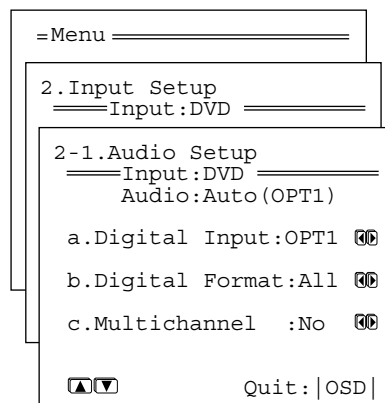

Initial settings for each input source

Input source	Digital input
CD	OPTICAL 1
PHONO	----
FM	-----
AM	-----
TAPE	----
VIDEO 4	----
VIDEO 3	OPTICAL 2
VIDEO2/VCR2	----
VIDEO1/VCR1	COAXIAL 2
DVD	COAXIAL 1

---- : Available for digital input but not set in initial settings.

----- : Not available for digital input.

Input Setup

a. Digital Input

This setting tells the DTR-7.1 which input source button on the front panel is connected with which digital input jack on the rear panel. To perform this setting, you must first select a digital input source at the front panel and then set the name of the digital input jack it is connected to here.

For example, if the input source selected at the front panel is CD and the compact disc player is connected to DIGITAL INPUT (OPTICAL) 1, then select "OPT1" here. If the input source selected is not connected to a digital input, then select "----."

OPT1: Select if connected to DIGITAL INPUT (OPTICAL) 1.

OPT2: Select if connected to DIGITAL INPUT (OPTICAL) 2.

COAX1: Select if connected to DIGITAL INPUT (COAXIAL) 1.

COAX2: Select if connected to DIGITAL INPUT (COAXIAL) 2.

----: Select if the input source is not from a digital input jack.

Note:

Do not assign a digital input to more than one input source. If you are making a digital connection that requires you to change the default settings, be sure to always first cancel the current digital input setting and then assign the new setting.

b. Digital Format

The default setting is "All." If "----" is selected for this input source at the Digital Input setting, then this setting will not appear. Although you can use this default setting as is, you may change it as desired depending on the input signal format (e.g., if you know that you will always be listening to a certain input signal format from a particular input source).

All: Select for automatic detection of the input signal format. The input signal format (Dolby Digital, DTS, PCM or Analog) used by the selected input source is detected automatically to execute the required decoding process.

DTS: Select for DTS signal processing. The decoding process is executed only when DTS signals are input.

PCM: Select for PCM signal processing. The decoding process is executed only when PCM signals are input.

Note:

If "All" is selected and a compact disc or LD is fast-forwarded during playback, decoded PCM signals may produce a skipping sound. In such cases, change the setting to "PCM."

Notes on DTS:

- If you play a CD or LD that supports DTS when the "PCM" setting is selected on the DTR-7.1, the DTS encoded signal will not be decoded and noise will be output. This noise could damage the amplifier and speakers. Therefore, be sure to select "All" or "DTS" and use the digital input jacks (OPTICAL or COAXIAL) to connect the DTS source.
- If you play a CD or LD that supports DTS when "All" is selected, you may hear a noise for a short while until the DTS decoder recognizes the DTS-encoded signal and starts operating. This is not a malfunction.
- If you press the PAUSE or SKIP button on the player while playing a DTS source, a short noise may be heard. This is not a malfunction. In such cases, try playing the source in the "DTS" selected.
- The DTS indicator on the DTR-7.1 lights while a DTS source is played. When playback finishes and the DTS signal transmission stops, the DTR-7.1 remains in DTS mode and the DTS indicator remains lit. This prevents noise when you operate the PAUSE or SKIP button on the player. Therefore, if the source is immediately switched from DTS to PCM, the PCM signal may not be played. In this case, stop the playback of the source on the player for about three seconds and then resume playback.
- You may not be able to play some DTS source signals from certain CD players and LD players even if you connect the player to the DTR-7.1 digitally. This is because the digital signal has been processed (such as the output level, sampling frequency, or frequency response) and the DTR-7.1 cannot recognize the signal as DTS data. Therefore you may hear noise when you play a DTS source while processing the signal.
- The outputs for the VIDEO 1 OUT, VIDEO 2 OUT, TAPE OUT, output analog audio signals. Do not record from CDs or LDs that support DTS using these outputs. If you do, the DTS-encoded signal will be recorded as noise.
- If a compact disc or LD encoded in the DTS format is played back with "PCM" selected, only noise will be produced. Always select "All" or "DTS" when playing back DTS-encoded sources.

c. Multichannel

This sub-menu will not appear if AM or FM is selected at the front panel for the input source. This setting is normally set to "No," and only needs to be changed to "Yes" if a DVD player, MPEG decoder, or other component that has a multi channel port is connected to the MULTI CHANNEL INPUT port for 5.1-channel, 6.1-channel, or 7.1-channel audio. For example, if a DVD player is connected to the MULTI CHANNEL INPUT port, then select DVD at the front panel as the input source, bring up this sub-menu, and select "Yes" for the Multichannel setting. You can only select Multichannel with the AUDIO SELECTOR button when "Yes" is selected here.

Note:

When playing a device that is actually connected to the MULTI CHANNEL INPUT terminal, select Multichannel with the AUDIO SELECTOR button.

Input Setup

2-2. Video Setup sub-menu

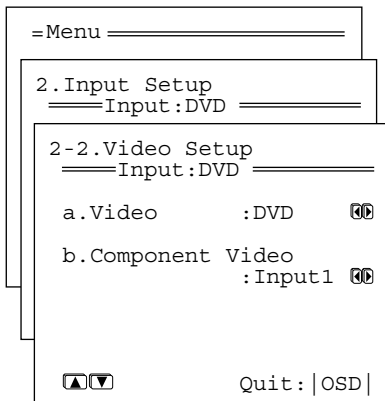

a. Video

This setting allows you to match the audio from one component with the video from another. Therefore, you can set a video source to be displayed while the audio from another input source is heard. For example, this allows you to play the music from a compact disc, while displaying the picture from a video cassette player or other video source.

The default settings are given below.

Input source selected	Video
CD	Last
PHONO	Last
FM	Last
AM	Last
TAPE	Last
DVD	DVD
VIDEO1	VIDEO1
VIDEO2	VIDEO2
VIDEO3	VIDEO3
VIDEO4	VIDEO4

Last : When you change to an input source set to “Last,” the video of the input source that you changed from is continued. For example, if the selected input source is VIDEO 1, and you then change to CD (set to “Last”), then the audio from the CD input is played while the video from VIDEO 1 continues.

- If no video signal is to be assigned to the input source, set “----.”

b. Component

If a component is connected to the one of the COMPONENT VIDEO inputs (1 or 2), then that input must be set here. This setting will not appear if AM, FM, PHONO, CD or TAPE is selected as the input source.

The default settings are given below.

Input source selected	Component video input
CD	----
PHONO	----
FM	----
AM	----
TAPE	----
VIDEO 4	----
VIDEO 3	INPUT 2
VIDEO 2/VCR 2	----
VIDEO 1/VCR 1	----
DVD	INPUT 1

---- : Not assigned with the default settings.

Input Setup

2-3. Listening Mode Preset sub-menu

With the DTR-7.1, you can set a different listening mode for each different signal type that comes from each input source and also set the parameters for the listening mode itself. For example, if your DVD player also plays compact discs and the DVD video signal is DTS and the compact disc signal is PCM, then you can set a different listening mode for each.

This is especially convenient if you frequently play the same types of movies or music.

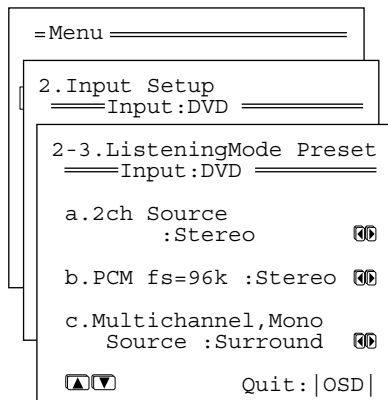

* The 5.1-channel digital surround format has a variety of versions including Dolby Digital and DTS. The 5.1-channel digital surround format enables you to individually record and play five full-range (20 Hz to 20 kHz) channels (left and right front, center, and two surround channels) plus an LFE channel (Low Frequency Effect) for the low-range effect sound. It will create a realistic sound that can be heard in the theaters and concert halls.

Input source signals

a. 2ch Source

Set a listening mode for the input signal from 2-channel analog sources, PCM sources, and 2/0-channel Dolby Digital and DTS sources.

b. PCM fs=96k

Set a listening mode for the input signal from digital PCM sources recorded with a sampling rate of 96 kHz.

c. Multichannel, Mono Source

Set a listening mode for the input signal from 2/1, 2/2, 3/0, 3/2-channel Dolby Digital and DTS sources. Or, set a listening mode for the input signal from 1/0-channel (Mono) Dolby Digital and DTS sources.

- The DTR-7.1 will automatically switch to the listening mode set for the current input signal. For example, even when using the same DVD player, if a CD is played, the listening mode automatically becomes "Stereo," and if a DVD is played (Dolby Digital 3/2.1), the listening mode automatically becomes Dolby D.

Relationship between input source and listening mode

Input source signal (display)	2ch	PCM fs=96k	Multichannel, Mono
Type of software	Tape, CD, Record, Tuner DVD Video (Stereo), LD (Stereo) Digital satellite broadcast	DVD	DVD, LD, Digital satellite broadcast DTS-CD
Listening Mode			
Direct	●	●	
Stereo	●	●	●
Theater-Dimensional	●		●
Surround	● (Pro Logic (3 Stereo), DolbyD, DTS)		● (DolbyD, Dolby D6.1, DTS, DTS-ES)
THX	● (Cinema)		● (Cinema, Surround EX)
Mono Movie	●		●
Enhanced 7	●		●
Orchestra	●		●
Unplugged	●		●
Studio-Mix	●		●
TV Logic	●		●
All Ch Stereo	●		

The listening modes that can be set are different for each input source format.

Note:

You may not be able to select all the listening modes shown here depending on your speaker configuration or the selected input source.

Input Setup

Listening Modes

Stereo

This mode has all input sound is output from the left and right front speakers.

Direct

This mode delivers pure sound with minimum sound quality adjustment and filtration. The sound recorded for the right and left front channels is output to the right and left front speakers only and not output to the subwoofer.

Mono Movie

This mode is suitable for playing back monaural recording such as old movie soundtracks. The center channel delivers the unprocessed original sound, whereas the other channels deliver the center-channel sound processed with the appropriate reverberation. This allows you to enjoy monaural sound with the atmosphere of a movie theater.

Surround modes

With this mode, decoding is performed automatically to match the input signal. This original mode adds no sound processing to the input signal.

- **DOLBY DIGITAL Surround, DTS (Digital Theater System) Surround**

This 5.1-channel digital surround format enables you to individually record and play five full-range (20Hz–20kHz) channels (left and right front, center, two surround channels) plus an LFE channel (Low Frequency Effect) for the low-range effect sound. It will create a realistic sound that could be heard in the theaters and concert halls.

Dolby D (Dolby Digital)

This mode is for listening to sources encoded in the Dolby Digital format.

Dialog normalization (Dialog Norm)

Dialog normalization is a feature of Dolby Digital. With this function, for example, if “Dialog Norm: +4” is displayed while playing back a Dolby Digital source, it means that that source material was recorded 4 decibels higher than normal. Thus, by lowering the volume by 4 decibels, it can be played back at the same standard level for other sources. However, since most source materials have been recorded at the same standard level, you will rarely need to adjust the volume.

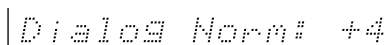

DTS

This mode is for playing back DTS sources.

- **Pro Logic/3 Stereo (Dolby Pro Logic/3 Stereo)**

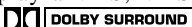
This mode is for playing back sources encoded using the Dolby Pro Logic format. Select this listening mode when you play a VHS, VHS hi-fi, LD, or DVD video that has the  mark.

This surround format consists of four channels (left, right, center, and monaural surround) and emphasizes the center channel. Dolby Pro Logic is very effective for panning music, conversation, and three-dimensional sound movement output from the three front channels. It also simulates the atmosphere and surround effects of the sound reflected from the side and rear walls of the theater.

If no surround speakers are connected, then the surround sound is divided and output from the front left and right channels (3 stereo).

THX

This mode is for playing back sources using THX.

This mode will work well with 5.1-channel Dolby Digital and DTS sources and Dolby encoded sources.

For excellent fidelity when playing back THX sounds, it is recommended to use a THX-certified speaker system.

- **THX Cinema**

This is the conventional 5.1-channel THX format. This mode should be used only when playing back sources that were mixed for playback in large movie theater environments.

- **THX Surround EX**

“THX Surround EX - Dolby Digital Surround EX” is a joint development of Dolby Laboratories and the THX division of Lucasfilm Ltd.

In a movie theater, film soundtracks that have been encoded with Dolby Digital Surround EX technology are able to reproduce an extra channel which has been added during the mixing of the program. This channel, called Surround Back, places sounds behind the listener in addition to the currently available front left, front center, front right, surround right, surround left, and subwoofer channels.

This additional channel provides the opportunity for more detailed imaging behind the listener and brings more depth, spacious ambience, and sound localization than ever before.

When released to the home consumer market, movies that were created using the Dolby Digital Surround EX technology, may have a note to that effect on the packaging. A list of movies created using this technology can be found on the Dolby web site at <http://www.dolby.com> <<http://www.dolby.com>> .

Only receiver and controller products bearing the THX Surround EX logo, when in the THX Surround EX mode, faithfully reproduce this new technology in the home.

This product may also engage the “THX Surround EX” mode during the playback of 5.1 channel material that is not Dolby Digital Surround EX encoded. In such case, the information delivered to the Surround Back channel will be program dependent and may or may not be very pleasing depending on the particular soundtrack and the tastes of the individual listener.

Input Setup

T-D (Theater-Dimensional)

For the best enjoyment of your home theater, it is recommended that you have at least front left and right speakers, a center speaker, and surround left and right speakers. However, even if you only have front left and right speakers, you can still enjoy multichannel audio by using this mode.

This mode controls the characteristics of the sound that reaches each ear to reproduce a multi-speaker setup. To receive the full effect, there is an optimum listening position (sweet spot). Refer to the explanation of the listening angle. In addition, if the reflective sound components are large, it may be difficult to achieve the desired result, so be sure to set up your system and listening position to minimize reflective sound.

Enhanced 7

Enhanced 7 intends to reproduce a natural surround environment by using 7-channel speakers. The sound effects moving smoothly toward the surround back. This mode is good for music and TV sports programs.

Orchestra

This mode is appropriate for classical and opera music. The center channel is cut and the surround channels are emphasized to widen the stereo image. It will simulate the natural reverberation that is created in large halls.

TV Logic

This mode gives realistic acoustics to TV programs that are aired from TV studios. It enhances the entire surround sound and clarity of the conversation.

Unplugged

This mode is suitable for acoustical instrumental sounds, vocals, and jazz music. By emphasizing the front stereo image, it will simulate the acoustics that you would experience in front of the stage.

Studio-Mix

This mode is for rock and popular music. The lively sounds are enhanced for a powerful acoustic image that simulates the feeling of being in a club or rock concert.

All Ch Stereo

This mode is designed for playing background music. The front, surround, and surround back channels create a stereo image that encompasses the entire area.

Input Setup

2-4. Tone Control sub-menu

This sub-menu allows you to increase or decrease the volume for only the low (bass) or high (treble) frequency sounds. This sub-menu does not appear if “Direct” or “THX” are selected as the listening mode.

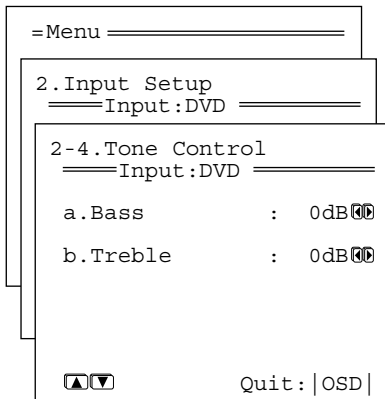

a. Bass

Press the ◀ cursor button to decrease the bass sounds and press the ▶ cursor button to increase the bass sounds. The bass can be adjusted between -12 and +12 decibels in two steps.

b. Treble

Press the ◀ cursor button to decrease the treble sounds and press the ▶ cursor button to increase the treble sounds. The treble can be adjusted between -12 and +12 decibels in two steps.

2-5. IntelliVolume sub-menu

When switching input sources, you may find that the output level for different components or input sources connected to the DTR-7.1 is different even though the main volume setting is the same. Under normal circumstances, you would then have to change the volume setting each time you change the input source. This IntelliVolume sub-menu allows you to preset a volume level for each input source separately so that when you do switch from one input source to another, the DTR-7.1 adjusts the volume accordingly so that the resulting volume stays the same. To set the IntelliVolume, simply select an input source at the front panel, and if that source is quieter than other sources, increase its decibel level with the ▶ cursor button, or if it is louder than other sources, decrease its decibel level with the ◀ cursor button.

The IntelliVolume can be adjusted between -12 and +12 decibels.

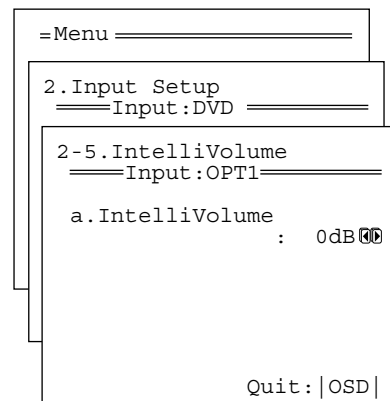

2-6. 12V Trigger sub-menu

This sub-menu allows you to make the required settings to turn on the output from the 12V TRIGGER terminal to control another component or device with the DTR-7.1 for each input source.

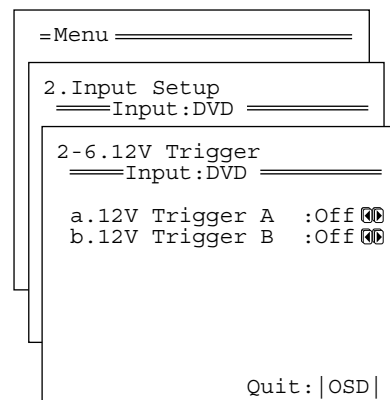

a. 12V Trigger A

On: Select to activate the device connected to the 12V TRIGGER A terminal when the input source is selected.

Off: Select when no device is connected to the 12V TRIGGER A terminal or you do not want the connected device to activate.

b. 12V Trigger B

On: Select to activate the device connected to the 12V TRIGGER B terminal when the input source is selected.

Off: Select when no device is connected to the 12V TRIGGER B terminal or you do not want the connected device to activate.

Listening Mode Setup

3. Listening Mode Setup menu

This menu allows you to make adjustments to the various listening modes. These adjustments are in the form of parameters and each one is explained below. Note that some parameters cannot be set for some listening modes and that no sub-menu will have all parameters. Also, for some input signal formats, changes in the listening mode parameters may actually result in no change to the resulting output signal.

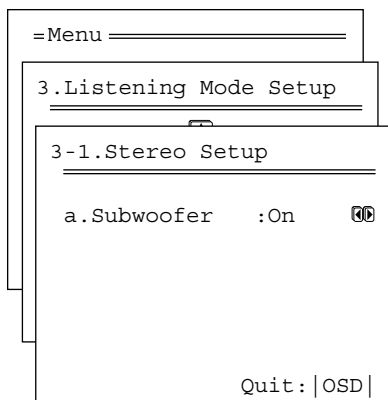
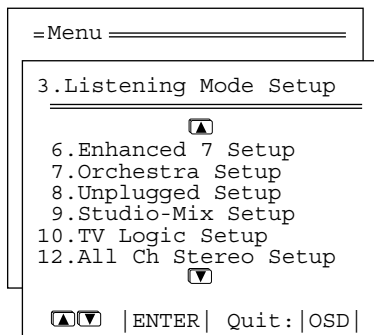
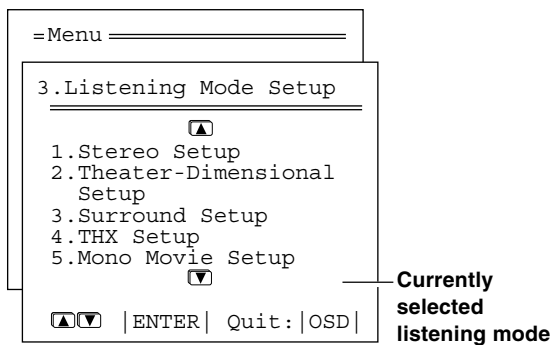

3-1. Stereo Setup

Select this to modify the Stereo listening mode. The parameters that can be set are shown in the table below.

	Parameter	Setting Initial value
a Subwoofer	Off, On	On

3-2. Theater-Dimensional Setup

Select this to modify the Theater-Dimensional (T-D) listening modes. The parameters that can be set are shown in the table below.

	Parameter	Setting Initial value
a Subwoofer	Off, On	On
b Listening Angle	20deg, 40deg	40deg
c Center	Off, On	Off
d Front Expander	Off, On	Off
e Virtual Surr Level	-3 dB to +3 dB	0 dB
f Dialog Enhance	Off, On	Off

3-3. Surround Setup

Select this to modify the plain Dolby Digital, DTS, and Pro Logic Surround listening modes. The parameters that can be set are shown in the table below.

	Parameter	Setting Initial value
a Subwoofer	Off, On	On
b Re-EQ	Off, On	Off
c Surround Speakers	Surround L/R, Surround Back*, Surround L/R+Back	Surround L/R
d Dolby D 6.1	Auto, On, Off	Auto
e DTS-ES	Auto, On, Off	Auto

* Surround Back can only be selected when two surround back speakers are connected to the DTR-7.1.

3-4. THX Setup

Select this to modify the THX listening modes; the one that is currently set is the one that is modified. The parameters that can be set are shown in the table below.

	Parameter	Setting Initial value
a Subwoofer	Off, On	On
b Re-EQ	Off, On	On
c Surround Speakers	Surround L/R, Surround Back*, Surround L/R+Back	Surround L/R
d Dolby D THX Surround EX	Auto, On, Off	Auto
e DTS THX Surround EX	On, Off	Off

* Surround Back can only be selected when two surround back speakers are connected to the DTR-7.1.

Listening Mode Setup

3-5. Mono Movie Setup

Select this to modify the Mono Movie listening mode. The parameters that can be set are shown in the table below.

	Parameter	Setting Initial value
a Subwoofer	Off, On	On
b Re-EQ	Off, Re-EQ	Off
c Surround Speakers	Surround L/R, Surround Back*, Surround L/R+Back	Surround L/R
d Front Effect	Off, On	On
e Effect Level	Low, Mid-low, Middle, Mid-high, High	Middle
f Room Size	Small, Mid-small, Middle, Mid-large, Large	Middle

* Surround Back can only be selected when two surround back speakers are connected to the DTR-7.1.

3-6. Enhanced 7 Setup

Select this to modify the Enhanced 7 listening mode. The parameters that can be set are shown in the table below.

	Parameter	Setting Initial value
a Subwoofer	Off, On	On
b Re-EQ	Off, On	Off
c Front Effect	Off, On	On
d Effect Level	Low, Mid-low, Middle, Mid-high, High	Middle
e Room Size	Small, Mid-small, Middle, Mid-large, Large	Middle

3-7, 8, 9, and 10. Orchestra Setup, Unplugged Setup, Studio-Mix Setup, TV Logic Setup

Select this to modify the Orchestra, Unplugged, Studio-Mix, and TV Logic listening modes; the one that is currently set is the one that is modified. The parameters that can be set are shown in the table below.

	Parameter	Setting Initial value
a Subwoofer	Off, On	On
b Re-EQ	Off, On	Off
c Surround Speakers	Surround L/R, Surround Back*, Surround L/R+Back	Surround L/R
d Front Effect	Off, On	On
e Effect Level	Low, Mid-low, Middle, Mid-high, High	Middle
f Room Size	Small, Mid-small, Middle, Mid-large, Large	Middle

* Surround Back can only be selected when two surround back speakers are connected to the DTR-7.1.

3-11. All Ch Stereo Setup

Select this to modify the All Ch Stereo listening mode. The parameters that can be set are shown in the table below.

	Parameter	Setting Initial value
a Subwoofer	Off, On	On
b Re-EQ	Off, On	Off

Listening Mode Setup

Description listening mode parameters

Subwoofer

Set this to “Off” if you are not using a subwoofer (even if one is connected). If “No” is selected for the Subwoofer setting in the Speaker Config sub-menu, then this setting will not appear.

Re-EQ

Depending on the listening mode, you can either turn Re-EQ on or off.

Re-EQ: Re-EQ (re-equalization) takes the edginess or “brightness” out of your home cinema sound to compensate for the fact that sound mixed for theaters may sound too bright when played back through speakers in the home environment.

On: Select to turn on the re-equalization filter.

Off: Select to turn off the re-equalization filter.

Surround Speakers

This setting allows you to decide which speakers to output to when surround back speakers are connected and you are playing back a 5.1-channel source.

Surround L/R: This outputs the sound to the surround left and right speakers as normal and outputs nothing to the surround back speaker.

Surround Back: This outputs the sound to the surround back speakers and outputs nothing to the surround left and right speakers. This setting can only be selected when two surround back speakers are connected to the DTR-7.1.

Sur L/R+Back: This outputs the sound to both the surround left and right speakers and the surround back speaker.

Dolby D 6.1

This setting allows you to set whether or not Dolby Digital sources will be played back using the matrix 6.1-channel output when a surround back speaker is connected.

Auto: Automatically outputs signals with EX-identifying signals using 6.1-channel Dolby Digital.

On: Outputs using 6.1-channel Dolby Digital regardless of whether or not the signal contains EX identifiers.

Off: Does not output using 6.1-channel Dolby Digital regardless of whether or not the signal contains EX identifiers (Dolby D is used).

However, if the surround channel is monaural or nonexistent, the playback is made using normal Dolby Digital regardless of the above setting. For Dolby Digital 6.1-channel playback, Dolby D 6.1 is displayed for the listening mode.

DTS-ES

This setting allows you to set whether or not DTS sources will be played back using the matrix 6.1-channel (DTS-ES) output when a surround back speaker is connected.

Auto: Automatically outputs signals with ES-identifying signals using DTS-ES playback.

On: Outputs using DTS-ES playback regardless of whether or not the signal contains ES identifiers.

Off: Does not output using DTS-ES playback regardless of whether or not the signal contains ES identifiers (DTS is used).

However, if the surround channel is monaural or nonexistent, the playback is made using normal DTS regardless of the above setting. For DTS-ES playback, DTS-ES is displayed for the listening mode.

Dolby D THX Surround EX

This setting allows you to set whether or not Dolby Digital sources will be played back using THX Surround EX when a surround back speaker is connected.

Auto: Automatically outputs signals with EX-identifying signals using THX Surround EX.

On: Outputs using THX Surround EX regardless of whether or not the signal contains EX identifiers.

Off: Does not output using THX Surround EX regardless of whether or not the signal contains EX identifiers (Dolby D is used).

However, if the surround channel is monaural or nonexistent, the playback is made using normal THX regardless of the above setting. For THX Surround EX playback, Dolby D THX Surround EX is displayed for the listening mode.

DTS THX Surround EX

This setting allows you to set whether or not DTS sources will be played back using the THX Surround EX when a surround back speaker is connected.

On: Outputs using THX Surround EX regardless of whether or not the signal contains ES identifiers.

Off: Does not output using THX Surround EX regardless of whether or not the signal contains ES identifiers (DTS is used).

However, if the surround channel is monaural or nonexistent, the playback is made using normal DTS regardless of the above setting. For THX Surround EX playback, DTS THX Surround EX is displayed for the listening mode.

Front Effect

Some live recordings contain acoustic reverberation. When you play these sources, more reverberation will be applied by the DSP, creating too much reverb effects and the sound loses frame or presence. In this case, set this setting to “Off.” No reverberation from the DSP will be applied to the sound output from the three front channels, so the sound source is played as it is without any further reverberation.

Effect Level

This parameter allows you to adjust the strength of sound effects to match the playback source material, the acoustics of your room, and such other factors. This can be set to “Low,” “Mid-low,” “Middle,” “Mid-high,” or “High.”

Room Size

This parameter allows you set virtual hall size to simulate for each surround mode. You can choose from “Large,” “Mid-Large,” “Middle,” “Mid-Small,” or “Small.”

Listening Mode Setup

Listening angle

The listening angle is the angle subtended by the front left and right speakers as seen from the listener. The setting of 20 and 40 degrees are only for nominal purposes, so select the setting that is closest to your actual listening angle.

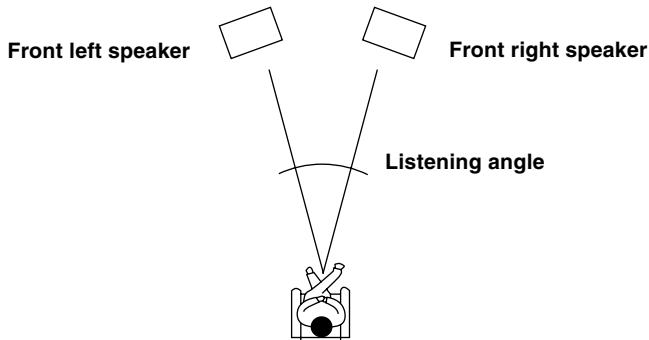

Center

For systems that have a center speaker, the center channel signal can be output from the center speaker. For instance, in systems where the front left and right speakers are small, use of the center speaker may provide a better sound space. (If your system uses a center speaker, be sure to perform the level calibration with the left and right speakers in the Speaker Setup menu beforehand.)

On: The center channel signal is output to the center speaker.

Off: The center channel signal is output from the front left and right speakers (Phantom Center).

Front Expander

The front expander function spreads out the sound from the front speakers for the feeling of a wide sound space.

On: Select to turn on the front expander function to simulate a wider sound space.

Off: Select to turn off the front expander function for a normal sound space.

Virtual Surr Level

This parameter adjusts the virtual surround level. This can be set from -3 to +3 decibels.

Dialog Enhance

This parameter allows you to adjust the dialog sound level from the center speaker if it is difficult to hear.

On: Enhances the vocal ranges for the center channel signal.

Off: Outputs the center channel signal at the regular level and frequency characteristics.

Relationship between listening mode and parameter

Listening mode	Direct	Stereo	T-D (Theater-Dimensional)	Surround*	THX	Mono Movie Orchestra Unplugged Studio-Mix TV Logic	Enhanced 7	All Ch Stereo
Parameter								
Subwoofer		●	●	●	●	●	●	●
Re-EQ				●	●	●	●	●
Surround Speakers				●	●	●		
Dolby D 6.1				●				
DTS-ES				●				
Dolby D THX Surround EX					●			
DTS THX Surround EX					●			
Listening Angle			●					
Center			●					
Front Expander			●					
Virtual Surr Level			●					
Dialog Enhance			●					
Front Effect						●	●	
Effect Level						●	●	
Room Size						●	●	

The parameters that can be set are different for each listening mode.

* The surround given here refers to basic surround modes and consists of Dolby Pro Logic, Dolby Digital, DTS, etc.

Preference

4. Preference menu

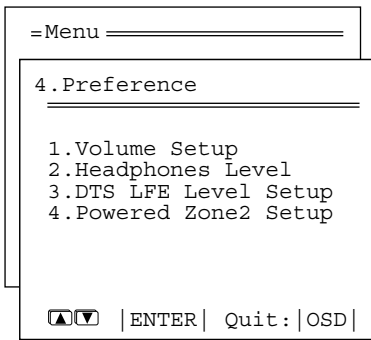

4-1. Volume Setup sub-menu

This sub-menu allows you to make various settings concerning the volume control of the DTR-7.1.

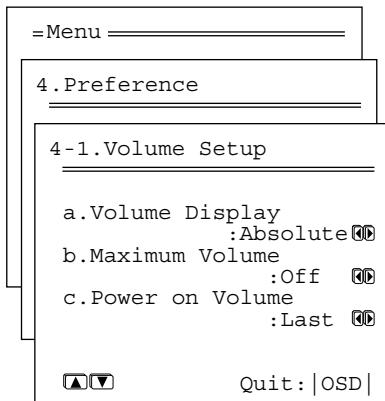

a. Volume Display

You can choose from two ways of displaying the volume setting on screen.

Absolute: This displays the volume with a minimum of min (0) for no sound and a maximum of max (80). As a reference, the volume setting of Ref (62) is used as the 0 -decibel for the relative display method.

Relative: This displays the volume as a decibel value on a scale with a designated reference point that is displayed as 0, which equals the volume setting of 62 for the absolute display method. With this display method, the minimum value is - , the next highest is -61, and the maximum value is +18.

b. Maximum Volume

This setting allows you to set the maximum volume that can be output with the Master Volume Dial To Prevent Components From Being Damaged By Excessively loud volumes. For the absolute volume display method, this can be set between 30 and 79. For the relative volume display method, this can be set between -32 and +17 decibels.

c. Power On Volume

This sets a designated volume setting for the DTR-7.1 to be set every time that the power is turned on. This prevents the DTR-7.1 from being turned on while it is set to an extremely high volume and suddenly output very loud sounds. For the absolute volume display method, this can be set between min and max. For the relative volume display method, this can be set between - and +18 decibels. If you do not mind having the DTR-7.1 turned on with its current volume setting, set this to "Last."

4-2. Headphones Level sub-menu

You can use this sub-menu to adjust the volume output from the headphones so that it matches the level output from the speakers. The headphone volume can be adjusted between -12 and +12 decibels.

4-3. DTS LFE Level Setup sub-menu

This sub-menu is used to set the LFE level for the playback of DTS sources. Normal playback is at 0 decibels; however, for some music software where the bass sounds are played back at high volumes, you can set this setting to -10 decibels.

4-4. Powered Zone2 Setup Sub-menu

Note:

Before performing the Powered Zone2 setting, set the Surr Back Out setting to "1ch." (See Speaker Setup → Speaker Config on page 30.)

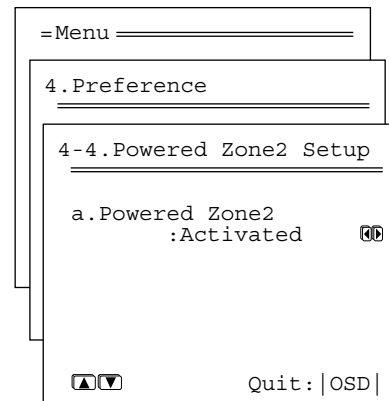

Activated: Select when speakers are connected to the ZONE2 SPEAKERS terminals. During playback in the remote zone (Zone 2), the listening mode for the main zone becomes either Stereo or Direct.

Not Activated: Select when you are connecting an amplifier to the ZONE 2 OUT terminals and connecting speakers to that amplifier.

OSD Setup

5. OSD Setup menu

This menu provides settings for you to customize the on-screen display (OSD) for the DTR-7.1 by setting different colors or positions for its display.

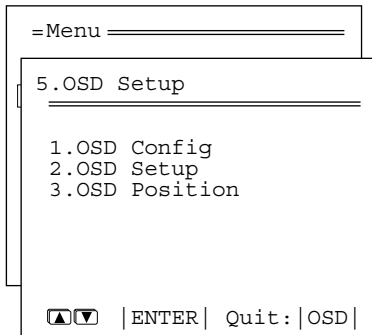

5-1. OSD Config sub-menu

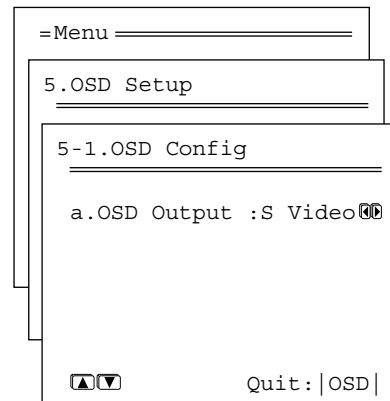

a. OSD output

This setting allows you to set the output of the ODS Menu. Select the video terminal to which your monitor is connected: "S VIDEO" or "VIDEO."

S Video: Outputs the OSD Menu through the S VIDEO MONITOR OUT terminals.

Video: Outputs the OSD Menu through the VIDEO MONITOR OUT terminals.

Note:

If the OSD Menu is not displayed on the television monitor you are using, confirm whether the television is connected to an S VIDEO MONITOR OUT terminal or VIDEO MONITOR OUT terminal.

OSD Setup

5-2. OSD Setup sub-menu

This sub-menu allows you to customize the OSD menu to display in the manner you desire.

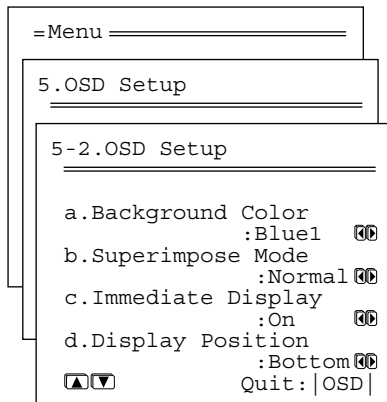

a. Background Color

Select either Blue1, Blue2, Green1, Green2, Magenta, Red1, or Red2 as the background color while the OSD menu is displayed.

b. Superimpose

Off: Select to have the OSD menu displayed on the selected background color.

Normal: Select to have the OSD menu superimposed over the current video if one is displayed or on the selected background color if there is no video signal.

Black: Select to have the OSD menu displayed on a black background at all times.

c. Immediate Display

On: Select this to have the screen immediately display certain operations as you perform them. The display will remain for a few seconds after the operation is completed.



Off: Select this to turn off the immediate display of operations.

Hint:

If this is set to “Off,” the background color will not be displayed even when there is no video signal input.

d. Display Position

Use this setting to select the position of the immediate display that appears when certain operations are performed. You can position the immediate display at any of ten different levels ranging from the top all the way to the bottom.

5-3. OSD Position sub-menu

This sub-menu allows you to adjust the position of the OSD menu as it is displayed on your screen. Depending on the monitor used, there may be cases where the OSD menu is not displayed in the center and parts of the menus are cut off. To adjust the position of the OSD menu, simply press the cursor buttons to inch the menu to position you desire.

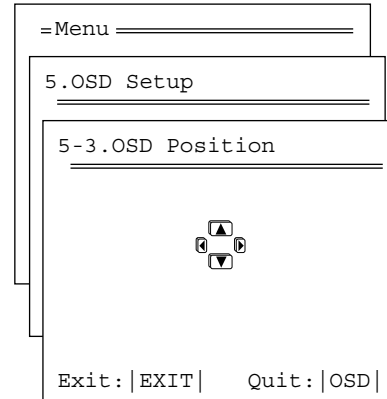

Enjoying music in the remote zone

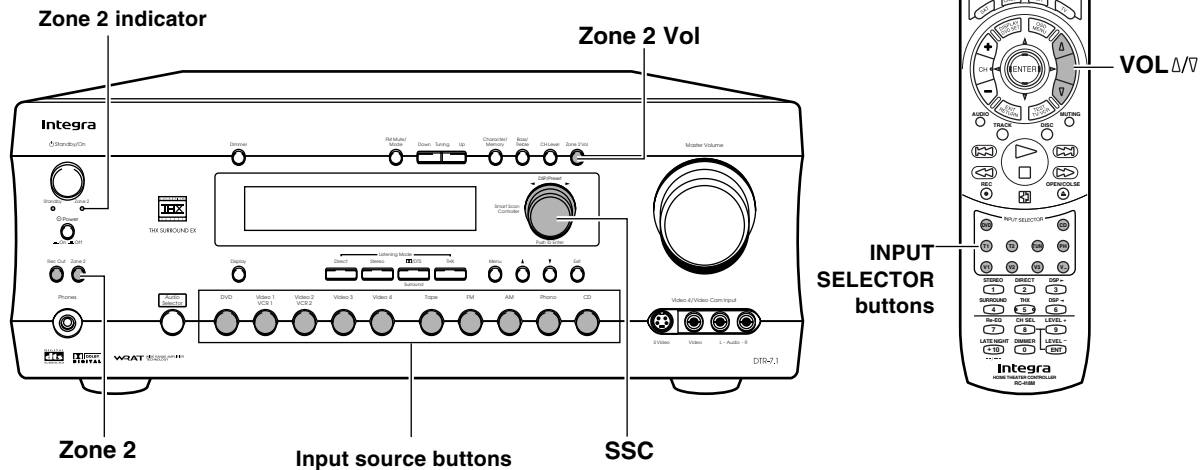

Controlling the DTR-7.1 from the remote zone

1. Aiming at the remote sensor, press the ON button on the remote controller.

Note:

Be aware that if you start using the system in the remote zone (Zone 2) while a recording is going on in the main zone, the recording will be stopped in the main zone.

2. Press the appropriate input selector button on the remote controller to select the desired source.

3. Adjust the volume to the desired level.

- When the speakers are connected to the ZONE 2 SPEAKERS terminals:
Adjust the volume using the VOL Δ/∇ buttons on the remote controller.
- When an amplifier is connected to the ZONE 2 OUT terminals:
Adjust the volume at the amplifier in the remote zone (Zone 2).

Controlling the DTR-7.1 without the remote controller

1. Press the Zone 2 button on the DTR-7.1.
2. Select a source.

After pressing the Zone 2 button, you must press an input source button within 3 seconds. The Zone 2 indicator lights.

Ex.: When the CD button is pressed.

```
Zone2Sel:#CD
```

To select the same source for the remote zone that is selected for the main zone, press the Zone 2 button again until "Zone2Sel:SOURCE" appears in the display.

```
Zone2Sel:#SOURCE
```

When "Zone2Sel:Off" is displayed, the output to the remote zone is turned off.

When speakers are connected to the ZONE 2 SPEAKERS terminals, you can adjust the volume using the controls at the DTR-7.1.

1. Press the Zone 2 Vol button.
2. While "ZONE 2Volume" is displayed, turn the SSC dial to adjust the volume to the desired level.

When an amplifier is connected to the ZONE 2 OUT terminals, you cannot adjust the volume at the DTR-7.1. Adjust the volume at the amplifier in the remote zone (Zone 2).

Caution:

If you are not using the system in the remote Zone, always press the Zone 2 button consecutively to turn the ZONE 2 function off.

Notes:

- If the source for the main zone is selected as the source for the remote zone and the source for the main zone is changed, then the source for the remote zone will change as well.
- The analog signals of the L and R channels for the selected source are output to Zone 2.
- You can only play the source in the Stereo mode or Direct mode in the main zone, when you are playing the source in the remote zone.
(When speakers are connected to the ZONE 2 SPEAKERS terminals.)
- If the Rec Out button is pressed in the main room while someone is using the system in the remote zone, the Zone 2 function will be deactivated and the source will turn off in the remote zone.
- The Zone 2 terminal is an analog output. Digital signals are not output. If no sound is heard from the selected input source,

Listening to Radio Broadcasts

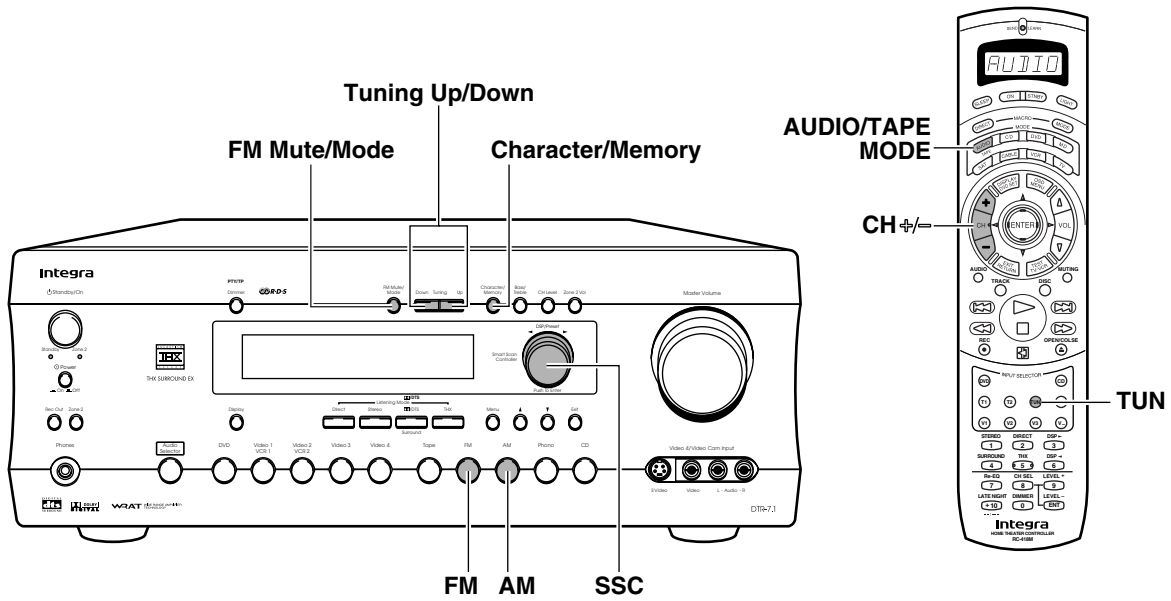

Listening to FM/AM Radio Stations

One of the features of the DTR-7.1 that is most frequently used is its ability to play FM and AM broadcast radio stations. The DTR-7.1 provides a number of listening modes perfect for listening to the radio and getting the most out of your audio system. Also, by presetting radio stations that you listen to frequently, you can select them easily by pressing the CH +/- button on the remote controller.

AM

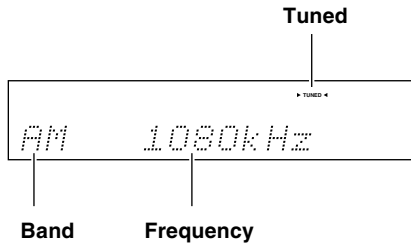

FM

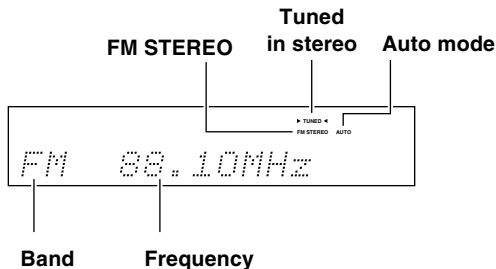

Tuning into a radio station

1. Press either the AM or FM input source button.
2. Using the Tuning Up and Down buttons on the front panel, tune into the station you desire.

When you tune into a radio station, TUNED indicator appears in the display. If you tune into an FM station in stereo, then "FM STEREO" appears. If the signal is weak, it may be impossible to tune into the station in stereo. In such a case, press the FM Mute/Mode button on the front panel. The AUTO indication disappears and the radio station is output in the monaural mode. To return to stereo, press the FM Mute/Mode button again. "AUTO" appears. Some inter-station noise may be heard, but the sound will not cut in and out as it would if stereo was selected.

- The tuner frequency changes in 50-kHz increments for FM and 10-kHz increments for AM.
- When tuning into FM stations, you can press the Tuning Up or Down button continuously for more than 0.5 seconds to scan for an FM station in the direction of the button you pressed (FM auto tuning mode). After you release the button and a station is received in stereo, the scanning stops.

Listening to Radio Broadcasts

Presetting a radio station

1. Tune into the radio station you desire (see “Tuning into a radio station”).

FM 88.10MHz

2. Press the Character/Memory button on the front panel.

Preset In?

“Preset in?” appears in the front display. Press the SSC dial.

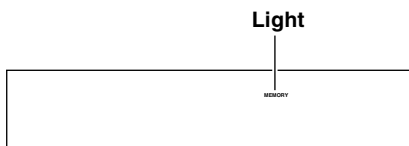

3. Turning the SSC dial, select a preset number (from 1 to 40) to assign the station to be preset.

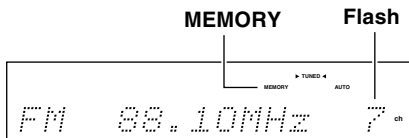

4. Press the SSC dial to finalize the procedure.

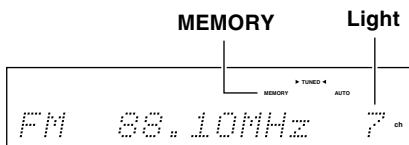

This programs the radio station as a preset radio station.

- Up to 40 stations can be stored in memory as preset radio stations.
- You can enter text names for any of the preset radio stations (see page 55).

Selecting a preset radio station

1. Press either the AM or FM input source button. The front display should show the currently selected frequency. If it displays the listening mode, press the Display button to display the frequency.
2. Turn the SSC dial and select the number of the desired preset station.

When using the remote controller:

1. Make sure that “AUDIO” is shown in the remote controller display and press the TUN button.

If “AUDIO” is not displayed, first press the AUDIO/TAPE MODE button to display “AUDIO” and then press the TUN button.

2. Press the CH +/- button and select the number of the desired preset station.

Erasing a preset radio station

1. Press the AM or FM button and turn the SSC dial to select the preset radio station that you want erase (see above).

2. Press the Character/Memory button.

“Preset Erase?” appears.

Preset Erase?

3. Press the SSC dial.

The selected preset station is erased.

Enjoying music or videos with the DTR-7.1

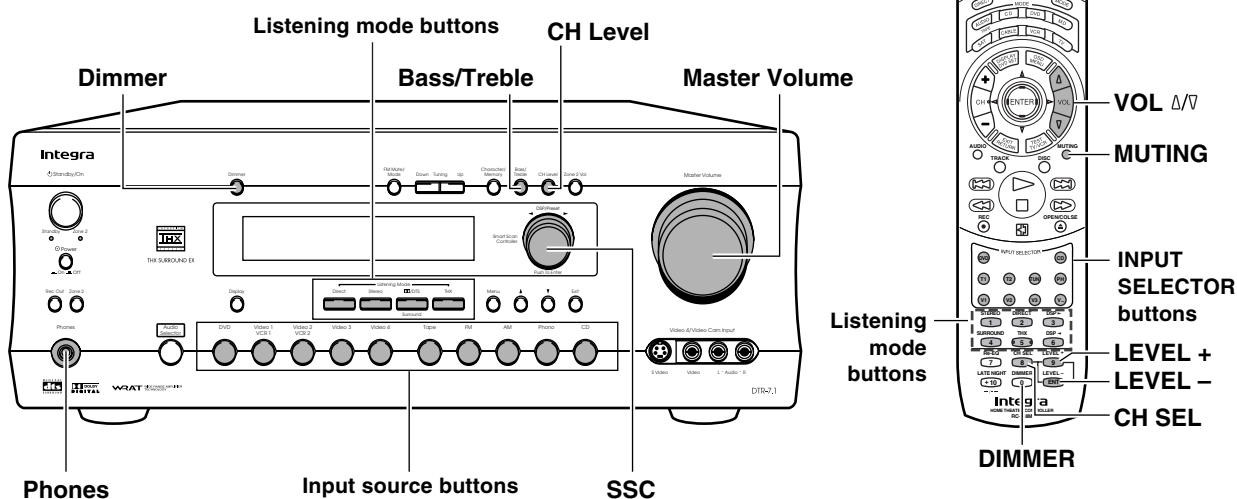

Though the DTR-7.1 is often used to listen to the radio, it does not show you its true ability until it is used to play music or watch videos, LDs, DVDs, and the like. The DTR-7.1 has the latest in state-of-the-art features to play back today's acoustic technologies with the utmost in fidelity and power. From a two-speaker system to a seven-speaker system, you are assured a sound space that you can always enjoy.

Selecting an input source

Before you can listen to any input media, you must first select the input source at the DTR-7.1. This tells it which input source to output to the speakers and monitor.

To select an input source, simply press the button on the front panel (or on the remote controller) that corresponds to the input source you want.

After you have selected the input source, simply turn on the corresponding component and play the media.

Adjusting the volume

Adjusting the main volume adjusts the volume level output from all the speakers connected to the DTR-7.1 together. If headphones are connected, this also adjusts the volume heard from the headphone speakers. To adjust the volume, either press the VOL Δ/∇ buttons on the remote controller or turn the Master Volume dial. To increase the volume, turn the dial to the right; to decrease the volume, turn the dial to the left.

Changing the listening mode

To change the listening mode during playback, turn the SSC dial on the front panel or the listening mode buttons on the remote controller (see page 57).

Listening with headphones

To listen with headphones, plug a pair of headphones with a standard stereo plug into the Phones jack on the DTR-7.1 front panel.

When you connect headphones, the unit will enter STEREO mode automatically and no sound will be heard from the speakers. Note that the signal to the remote zone (Zone 2) will not be affected whether or not headphones are connected.

Enjoying music or videos with the DTR-7.1

Using the many features of the DTR-7.1

Outputting from different input source:

You can have the DTR-7.1 output the audio of one input source through the speakers while the video of another input source is output to the monitor (see page 36).

Assigning names to input sources:

You can enter a name for each input source so that when the source is selected the name of that source is displayed in the front display of the DTR-7.1 (see page 55).

Temporarily changing the speaker output levels:

To change the individual speaker volumes temporarily, use the remote controller and follow the procedure given below. Note that the calibration settings will return to the original settings when the DTR-7.1 is put in standby.

1. Press the CH SEL button and select the desired speaker.
2. Press the LEVEL + or – button to adjust the volume level.

Using the sleep time:

To set the sleep timer, press the SLEEP button on the remote controller and then set the time that you want the DTR-7.1 to enter the standby state (see page 57).

Temporarily turning off the sound:

To turn off the sound momentarily, such as when interrupted by a phone call, press the MUTING button on the remote controller (see page 57).

Adjusting the bass and treble:

You can adjust the bass and treble levels at the Tone Control sub-menu of the OSD menu: Input Setup → Tone Control (see page 40). You can also press the BASS/TREBLE button on the front to display either “BASS” or “TREBLE” in the front display (the display will change each time the button is pressed) and turn the SSC dial to adjust the volume. This function only affects the front left and right speakers, the center speaker, and the subwoofer.

Adjusting the brightness of the front display:

You can adjust the brightness of the front display of the DTR-7.1 with DIMMER button on the remote controller (see page 57).

If one of the messages shown below appears

If you try to perform an operation that is not possible, “Not available” appears followed by one of the messages shown below to explain the reason.

with Headphones use

The operation is not allowed because headphones are plugged into the DTR-7.1.

with Multichannel use

The operation is not allowed because the selected input source is set for multichannel input.

in this Sp Config

The operation is not allowed by the current speaker configuration.

in Zone 2 mode

The operation is not allowed because the Zone 2 mode is turned on.

Only available with Dolby D

No setting other than Dolby Digital can be set.

Enjoying the multichannel input

Before you can use a component with multichannel output, you must first select “Yes” for the Multichannel setting in the OSD menu for that input source: Input Setup → Audio Setup (see page 34). Also, select “Multichannel” using the Audio Selector button on the front panel.

- 1. Press the input source button for the component with multichannel output connected to the MULTI CHANNEL INPUT on the rear of the DTR-7.1.**
- 2. Turn on the connected component and start playing the desired media.**
- 3. If necessary, press the CH SEL button on the remote controller to select an individual speaker. Then press the LEVEL + or – button to adjust the output level as desired.**

Adjust the speaker output levels so that you can hear the same sound level from each speaker at the listening position. For the front right, front left, center, surround right, surround left, surround back right and surround back left speakers, the output levels can be adjusted between –12 to +12 decibels. The subwoofer can be adjusted between –15 and +12 decibels.

- 4. Adjust the volume with the Master Volume dial or the VOL Δ/∇ buttons on the remote controller.**

Recording a source

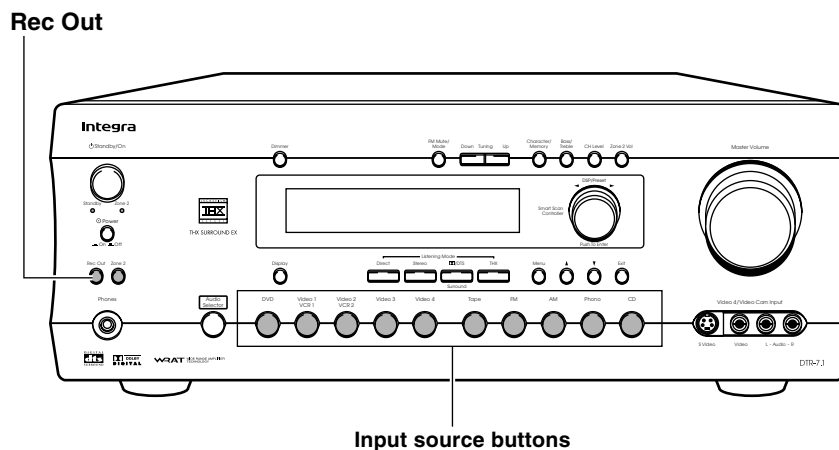

Of course the DTR-7.1 can also be used to record an input source media. This allows you to make copies of the music or videos you like, copy them from one type of media to another, or even record what is being broadcast on television or radio. Be aware that the Rec Out and Zone 2 buttons use the same circuit so that you cannot make recording and output to the remote zone (Zone 2) at the same time.

To record the input source signal you are currently watching or listening to

This method outputs to the audio and video outputs the currently selected input source signal. This method allows you to a signal while you are actually listening to or watching it.

1. Select the input source to record by pressing the corresponding input source button.

The input source is now selected and you may watch or listen to it as desired.

2. Press the Rec Out button repeatedly until "Rec Sel:SOURCE" appears in the front display.

The currently selected input source signal to the TAPE OUT, VIDEO 1 OUT, VIDEO 2 OUT outputs for recording.

3. Start recording at the recording component as

`Rec Sel :SOURCE`

desired.

To confirm the settings, press the Rec Out button. The current settings will appear for 3 seconds in the front display.

Notes:

- If you change the input source during recording, you will record the signals from the newly selected input source.
- You cannot record the surround effects.
- Digital signals input to the DIGITAL INPUT (COAXIAL) and DIGITAL INPUT (OPTICAL) inputs will be output to the DIGITAL OUTPUT (OPTICAL) output.
- Digital input signals are only output to the digital outputs and analog input signals are only output from the analog outputs. There is no conversion from digital to analog or vice versa. When connecting CD players and other digital components, do not connect only the digital terminals, but the analog ones as well.
- There are some restrictions on recording digital signals. When making digital recordings, consult the instruction manual that came with your digital recording equipment (e.g., MD recorder or DAT deck) to know what restrictions are imposed.
- You cannot record the source connected to the MULTI CHANNEL INPUT connector.

Recording a source

To record an input source signal different from that you are currently watching or listening to

This method outputs to the audio and video outputs the signal from the input source that you select here. This allows you to record an input source signal different from that which you are listening to or watching at the time of recording.

1. **Press the Rec Out button.**
2. **Within 3 seconds, press the input source selector button of the input source signal that you wish to record.**

The signal from the selected input source will now be output to the TAPE OUT, VIDEO 1 OUT, and VIDEO 2 OUT outputs for recording.

```
Rec Sel #VIDEO3
```

3. **Start recording at the recording component as desired.**

To confirm the settings, press the Rec Out button. The current settings will appear for 3 seconds in the front display.

Notes:

- Be aware that the remote (Zone 2) and recording (Rec Out) outputs use the same circuit and therefore can be used at the same time.
- You cannot record the surround effects.
- Digital signals input to the DIGITAL INPUT (COAXIAL) and DIGITAL INPUT (OPTICAL) inputs will be output to the DIGITAL OUTPUT (OPTICAL) outputs.
- There are some restrictions on recording digital signals. When making digital recordings, consult the instruction manual that came with your digital recording equipment (e.g., MD recorder or DAT deck) to know what restrictions are imposed.
- You cannot record the source connected to the MULTI CHANNEL INPUT connector.

Recording the video from one source and the audio from another

You can add the sound from one source to the video of another source to make your own video recordings.

Below is an example of recording the sound from a compact disc player connected to CD IN and the video from a video camera connected to VIDEO 4 IN to video cassette tape in a video cassette recorder connected to the VIDEO 1 OUT jack.

1. **Press the CD input source button.**
2. **Set "VIDEO 4" for the Video setting in the Video Setup sub-menu of the OSD menu: Input Setup → Video Setup → Video.**
3. **Insert a CD in the CD player and insert a tape in the video camera connected to the VIDEO 4 IN.**
4. **Insert a video tape for recording in the video cassette recorder connected to VIDEO 1 OUT.**
5. **Press the Rec Out button repeatedly until "Rec Sel:SOURCE" appears in the front display.**

Now "CD" has been selected as the audio input source and "VIDEO 4" as the video input source.

6. **Start recording on the video cassette recorder and start playing at the CD player and video camera as desired.**

Notes:

- If you change the input source during recording, you will record the audio signals from the newly selected input source and the video signals assigned to that input source.
- You cannot record the surround effects.

Giving a name to each input source and preset radio station

Giving a name to each input source

You can program names for each input source (e.g., DVD, CD) and preset channel.

Characters available for name entry

A B C D E F G H I J K L M N O P Q R S T U V W X Y Z
a b c d e f g h i j k l m n o p q r s t u v w x y z
0 1 2 3 4 5 6 7 8 9 - . ' () + * / = , ; ! ? _ (space)

1. Select the source to which you wish to enter a name by pressing the corresponding input selector button.

2. Press the Character/Memory button.

“Name In ?” appears.

3. Press the SSC dial.

Now you can enter a name.

4. Rotate the SSC dial to select the character you wish to enter and then press the SSC dial.

5. Enter a name of up to 10 characters.

The name entry mode is canceled automatically when you finish entering 10 characters.

If you enter a name of less than 10 characters, press the Character/Memory button.

To erase a name

1. Select the source whose name you wish to erase by pressing the corresponding input selector button.

2. Press the Character/Memory button twice.

“Name Erase ?” appears.

3. Press the SSC dial.

The entire name is erased.

Giving a name to each preset radio station

You can give a desired name to each preset radio station.

1. Select the preset radio station to which you wish to enter a name.

Then, follow steps 2 through 5 of the above procedure “Giving a name to each input source” to give a name to each preset radio station. To change or erase a name, see to “To change a name” and “To erase a name.”

To change a name

1. Select the source whose name you wish to change by pressing the corresponding input selector button.

2. Press the Character/Memory button.

“Name In ?” appears.

3. Press the SSC dial.

Now you can change the name.

4. Press the Tuning Up/Down button to select the character you wish to change.

5. Rotate the SSC dial to select the character you wish to enter and then press the SSC dial.

The name entry mode is canceled automatically when you finish entering 10 characters.

If you enter a name of less than 10 characters, press the Character/Memory button.

Using remote controller

Overview

The RC-418M remote controller is a useful tool to help you operate the components of your home theater. To do so, first press the Mode button that corresponds to the device you wish to control. At this time, the display on the remote controller will change to show the component that is selected. Then simply press the desired operation button and the component will operate accordingly. For example, if you wish to select the CD input source at the DTR-7.1 with the remote controller, first press the AUDIO/TAPE MODE button to select the DTR-7.1 ("AUDIO" will appear on the display) and then press the CD (INPUT SELECTOR) button.

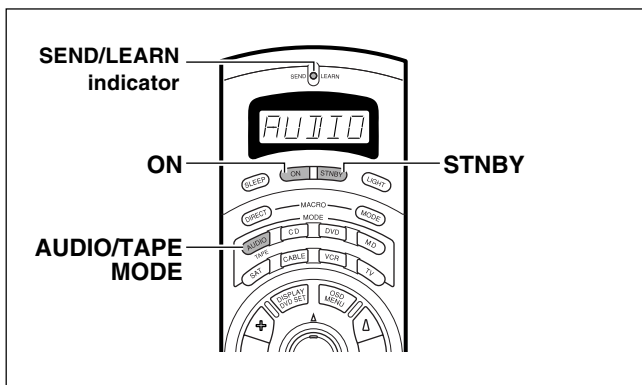

Using the remote controller to control each device

In order to use the remote controller, you must first turn on the POWER switch at the DTR-7.1 so that it enters standby mode.

1. Press the AUDIO/TAPE MODE button.

"AUDIO" appears in the remote controller display.

2. Press the ON button to turn on the DTR-7.1 and press the STNBY button to put it back in the standby mode.

When you press the STNBY button on the remote controller, it puts the DTR-7.1 in the standby state but does not turn it completely off.

SEND/LEARN indicator

This indicator acts as a guide when commands are programmed into or sent by the remote controller. It also warns the user when an error is made or battery power is low.

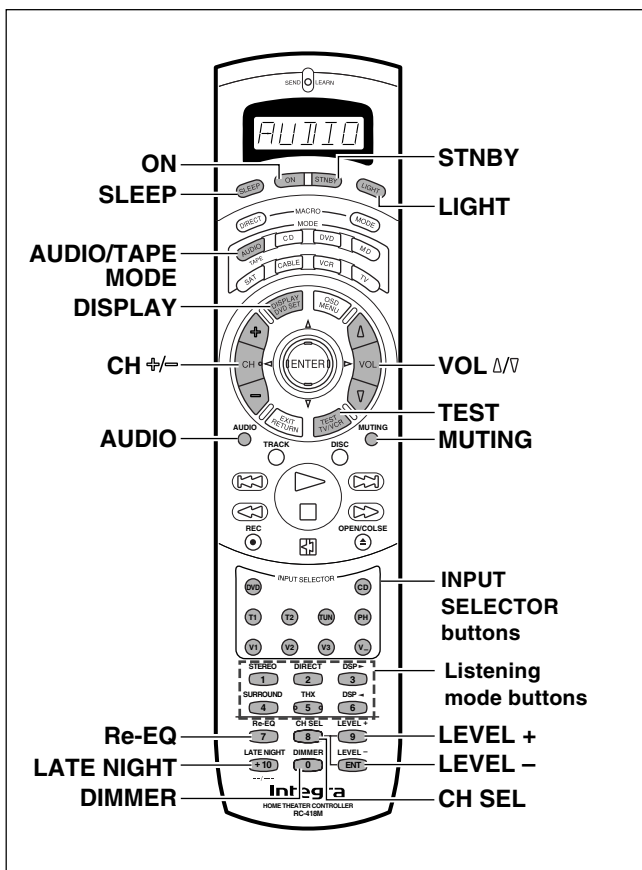

Controlling the DTR-7.1

If "AUDIO" is already appears in the display, proceed to step 2.

1. Press the AUDIO/TAPE MODE button.

"AUDIO" appears in the remote controller display.

2. Press the desired operation button. The buttons shaded in the figure to the left are the operation buttons that can used to control the DTR-7.1.

Using remote controller

LIGHT: Illuminates the buttons.

SLEEP: Sets the sleep function.

- The SLEEP buttons enables you to set the DTR-7.1 to turn off automatically after a specified time period. If you press it once, the DTR-7.1 will turn off after 90 minutes. Each time it is pressed thereafter, the remaining time until the DTR-7.1 turns off decreases by 10 minutes. While, the sleep function is enabled, you can press the SLEEP button to see how much time is left. To cancel the sleep function, press the SLEEP button when the time displayed is less than 10 minutes.

ON/STNBY: Turns on the DTR-7.1 or puts it in standby.

DISPLAY: Changes the display.

- Same as the DISPLAY button on front panel of the DTR-7.1.

VOL Δ/∇ : Adjusts the volume.

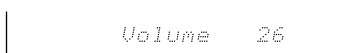

CH \neq /: Selects the tuner preset stations.

TEST: Outputs a test tone for setting speaker levels.

- Use this button in conjunction with the LEVEL +/- and CH SEL buttons to calibrate the speakers levels without entering the OSD Menu. When TEST button is pressed, the test noise (pink noise) is output. Use the LEVEL +/- buttons to increase or decrease the sound level. Use the CH SEL button to change from speaker to speaker. For a more detailed explanation of how to calibrate the speaker levels, see page 32.

MUTING: Activates the mute function.

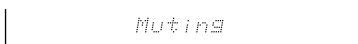

- This button mutes the playback sound immediately. This can be useful, for example, when you receive a telephone call while listening to music or another source. When pressed, "Muting" is displayed on the DTR-7.1. Press the MUTING button again to turn the sound back on.

AUDIO: For selecting the audio input signal. The setting changes from "AUTO" to "Multichannel" to "Analog" and back each time this button is pressed.

INPUT SELECTOR: Selects an input source.

- Same as the input selector buttons on front panel of the DTR-7.1.

Re-EQ: Depending on the listening mode, you can turn the cinema re-equalization function on or off.

- The re-equalization function takes the edginess or "brightness" out of your home cinema sound to compensate for the fact that sound mixed for theaters may sound too bright when played back through speakers in the home environment.

LATE NIGHT: Sets "High," "Low," or "Off" for the late night function.

- Cinema sound has a vast dynamic range; therefore, to hear the quieter sounds such as human conversations, they must be played back at larger volumes. When this parameter is set to "High" or "Low," the dynamic range of the sound is narrowed down to allow you to easily hear minute sounds at low volumes. This function is especially useful if you wish to play a movie at low volumes during the nighttime.

Notes:

- The depth of the Late Night effect is determined by Dolby Digital software. Some sounds may produce no or little effect.
- The Late Night function is effective only on Dolby Digital encoded software.

CH SEL: Selects a speaker for changing the speaker output level.

- See TEST button above.

DIMMER: Adjusts the display brightness.

- There are three settings available: normal, dark and very dark.

LEVEL +: Increases the speaker level.

- See TEST button above.

LEVEL -: Decreases the speaker level.

- See TEST button above.

Listening mode buttons

STEREO: Changes the listening mode directly to the Stereo listening mode.

- If pressed, the listening mode for the selected input source set in the Listening Mode Preset sub-menu is also changed to the Stereo listening mode.

SURROUND: Changes the listening mode to the surround mode for the current input signal (e.g., Dolby Pro Logic, Dolby Digital, or DTS).

- If pressed, the listening mode for the selected input source set in the Listening Mode Preset sub-menu is also changed to the Surround listening mode. If Dolby Digital or DTS was already set as the listening mode:

The operating mode for the 6.1-channel matrix playback of sources that allow 6.1-channel matrix playback will change as follows (see page 43):

Auto→On→Off→Auto...

DIRECT: Changes the listening mode directly to the Direct listening mode.

- If pressed, the listening mode for the selected input source set in the Listening Mode Preset sub-menu is also changed to the Direct listening mode.

THX: Changes the listening mode to the THX listening mode.

- If pressed, the listening mode for the selected input source set in the Listening Mode Preset sub-menu is also changed to the THX listening mode. The operating mode for the THX Surround EX playback of sources that allow THX Surround EX playback will change as follows (see page 43):

Auto→On→Off→Auto...

- * "Auto" only appears for Dolby Digital sources.

DSP $\blacktriangleleft/\blacktriangleright$: Changes the listening mode as shown below.

Direct ↔ Stereo ↔ Theater-Dimensional ↔ Surround ↔ THX ↔ Mono Movie ↔ Enhanced7 ↔ Orchestra ↔ Unplugged ↔ Studio-Mix ↔ TV Logic ↔ All Ch Stereo ↔ Direct.

- If pressed, the listening mode for the selected input source set in the Listening Mode Preset sub-menu is also changed.

Using remote controller

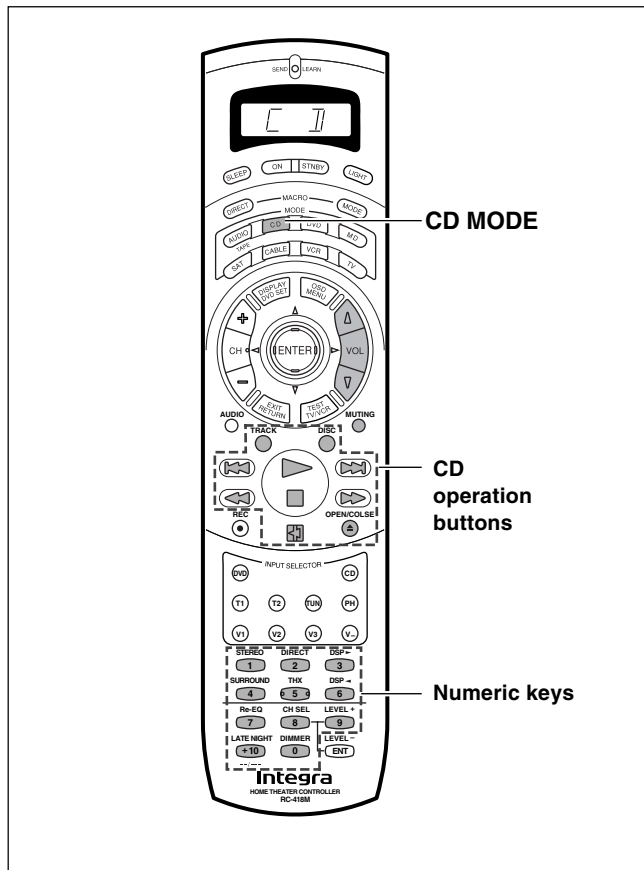

Controlling an Integra/Onkyo CD player

The RI connector of the Integra/Onkyo compact disc player must be connected to the DTR-7.1 (see page 13).

1. Press the CD MODE button.

“CD” appears in the remote controller display.

2. Press the desired operation button. The buttons shaded in the figure to the left are the operation buttons that can be used to control an Onkyo compact disc player.

TRACK: Selects a track

DISC: Selects a disk in the CD changer

⏮: Track down

⏭: Track up

▶: Play

⏏: Stop

⏪: Fast reverse

⏩: Fast forward

⏸: Pause

OPEN/CLOSE ⏏: Open/close the disc tray

0, 1 to 9, +10: Numeric keys

You may also use the following buttons:

VOL ⏴/⏵: Adjusts the volume at the DTR-7.1

MUTING: Activates the muting function at the DTR-7.1

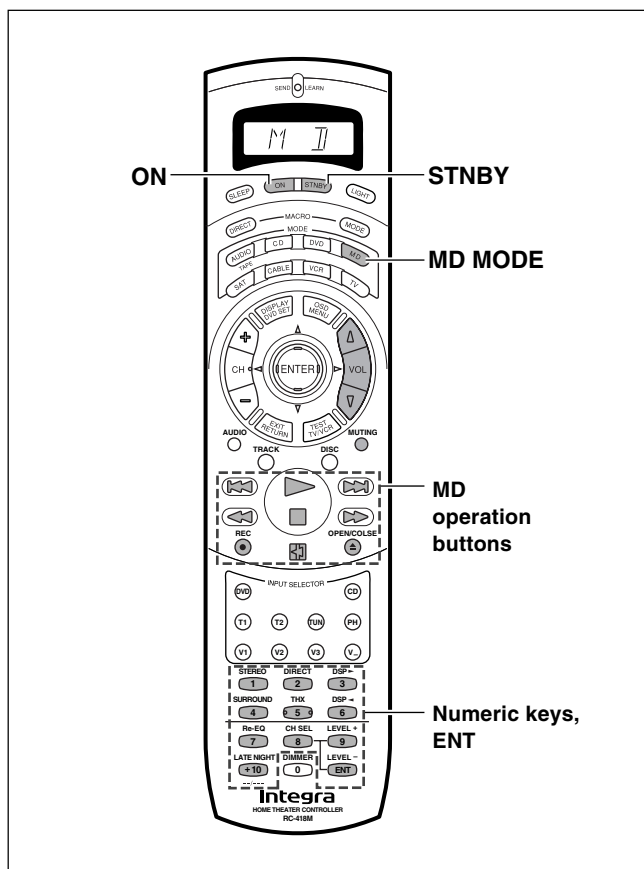

Controlling an Integra/Onkyo MD recorder

Make sure that you point the remote controller toward the sensor on the Integra/Onkyo MD recorder.

1. Press the MD MODE button.

“MD” appears in the remote controller display.

2. Press the desired operation button. The buttons shaded in the figure to the left are the operation buttons that can be used to control an Onkyo mini disc player.

ON/STNBY: Turns the mini disc player on and off

⏮: Track down

⏭: Track up

▶: Play

⏏: Stop

⏪: Fast reverse

⏩: Fast forward

REC ●: Record

⏸: Pause

⏏: Eject the disc

1 to 9, +10: Numeric keys

ENT: Enters the settings

You may also use the following buttons:

VOL ⏴/⏵: Adjusts the volume at the DTR-7.1

MUTING: Activates the muting function at the DTR-7.1

Using remote controller

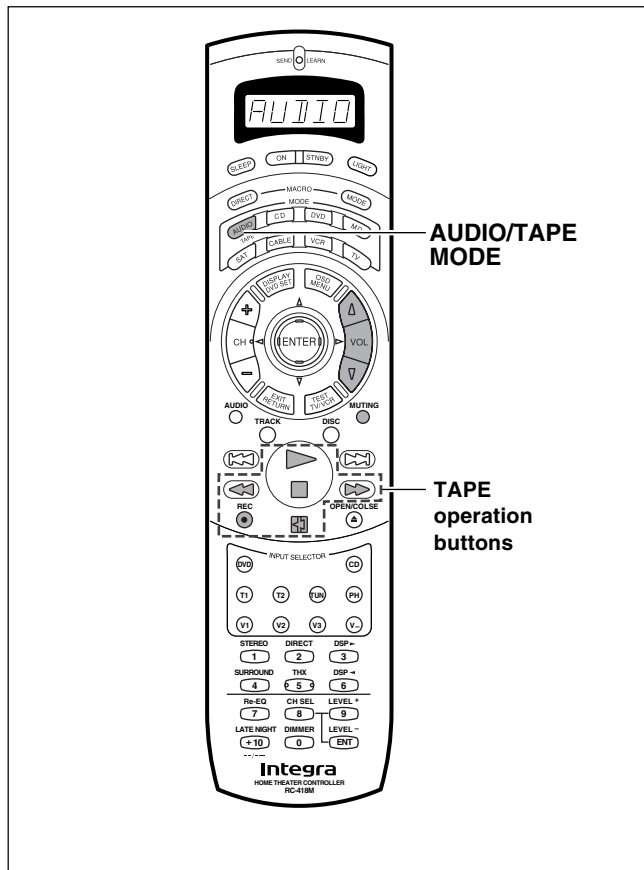

Controlling an Integra/Onkyo cassette tape deck

The **RI** connector of the Integra/Onkyo cassette tape deck must be connected to the DTR-7.1 (see page 13).

1. Press the AUDIO/TAPE MODE button.

"AUDIO" appears in the remote controller display.

2. Press the desired operation button. The buttons shaded in the figure to the left are the operation buttons that can be used to control an Onkyo cassette tape player.

- ▷: Play
- ◻: Stop
- ◀◀: Rewind
- ▶▶: Fast forward
- REC ●: Record
- ◻◻: Reverse playback

You may also use the following buttons:

VOL Δ/∇ : Adjusts the volume at the DTR-7.1

MUTING: Activates the muting function at the DTR-7.1

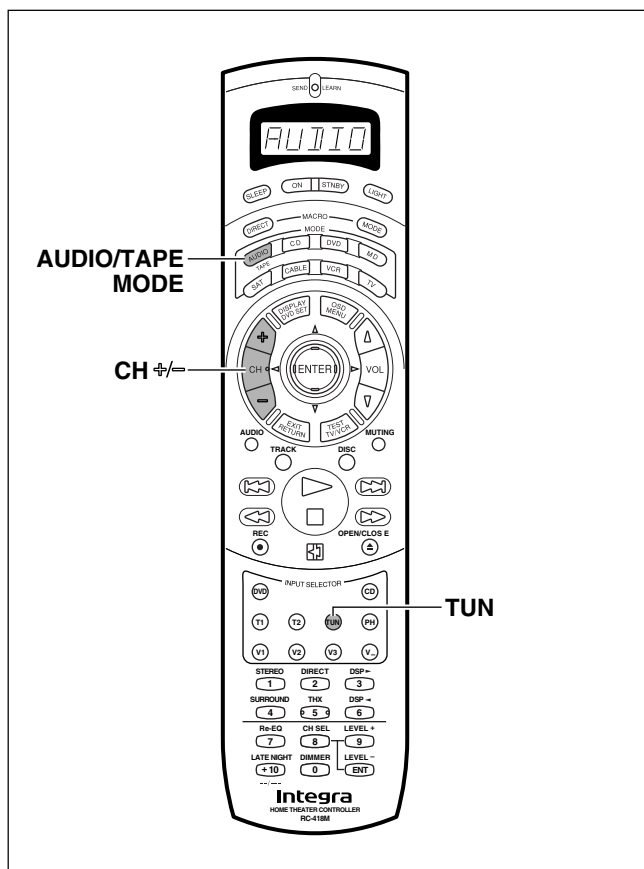

Calling up a preset radio station

1. Press the AUDIO/TAPE MODE button.

"AUDIO" appears in the remote controller display.

2. Press the TUN input selector button.

"(TUN)" appears in the remote controller display and momentarily and then "AUDIO" reappears.

3. Press the CH + or - button to select the desired the preset station number.

Using remote controller

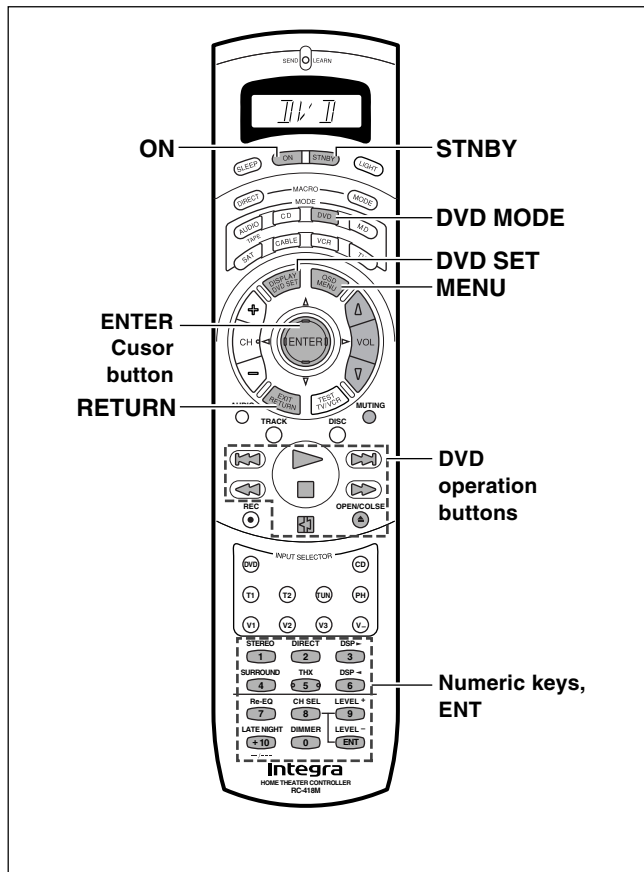

Controlling an Integra DVD player

Make sure that you point the remote controller toward the sensor on the Integra DVD player.

1. Press the DVD MODE button.

“DVD” appears in the remote controller display.

2. Press the desired operation button. The buttons shaded in the figure to the left are the operation buttons that can be used to control an Onkyo DVD player.

ON/STNBY: Turns the DVD player on and off

DVD SET: Enters the DVD setup menu

DVD player on-screen buttons

MENU: Displays the menu

$\Delta/\nabla/\leftarrow/\rightarrow$: Moves the cursor

ENTER: Confirms the selection

RETURN: Return buttons

DVD player buttons

\leftarrow : Chapter/Track down

\rightarrow : Chapter/Track up

\triangleright : Play

\square : Stop

\leftarrow : Fast reverse

\rightarrow : Fast forward

\boxtimes : Pause

OPEN/CLOSE \blacktriangle : Open/close the disc tray

0, 1 to 9, +10: Numeric keys

ENT: Confirm

You may also use the following buttons:

VOL Δ/∇ : Adjusts the volume at the DTR-7.1

MUTING: Activates the muting function at the DTR-7.1

Note:

The ENT button on the bottom right of the numeric keys has the same function as “ENTER” of the ENTER/cursor button.

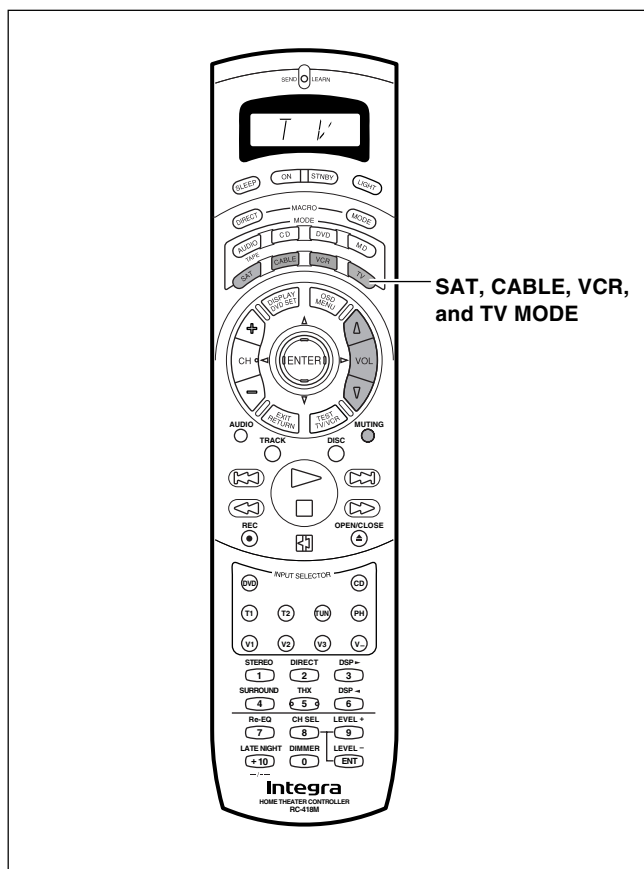

SAT, CABLE, VCR, and TV MODE buttons

No preset codes are programmed into the SAT, CABLE, VCR, and TV MODE buttons. You can use these buttons to program the remote controller signals of other devices (see page 61).

You may use the following buttons:

VOL Δ/∇ : Adjusts the volume at the DTR-7.1

MUTING: Activates the muting function at the DTR-7.1

Programming the commands of remote controllers for other devices into the remote controller

The remote controller has two learning functions. One is a normal learning function that enables the remote controller to learn the codes from other remote controllers. The other is a macro learning function that enables you to program a series of operations into the remote controller so that they can all be performed at once by pressing one button.

Programming procedure

When programming the commands of another remote controller, you must first decide under which MODE button you want the commands to be linked. In general, you will select the MODE button that corresponds to the component you are programming. For example, if you are programming the functions from a remote controller for a compact disc player, you would choose the CD MODE button. Then, by pressing the CD MODE button, the buttons on the RC-418M remote controller will change to the commands you program here to operate the compact disc player.

After programming which MODE button to use, you will then transfer the separate commands from the other remote controller over to the RC-418M remote controller one at a time. Each command is then programmed to a different button on the RC-418M remote controller. Any button is programmable for this step except for the eight MODE buttons (AUDIO, CD, DVD, MD, SAT, CABLE, VCR, and TV), the two MACRO buttons (DIRECT and MODE), and the LIGHT button.

Even after the commands have been memorized, keep your old remote controller in a safe place. If for some reason the commands are lost (e.g., when the batteries run down), it will be necessary to memorize them once again.

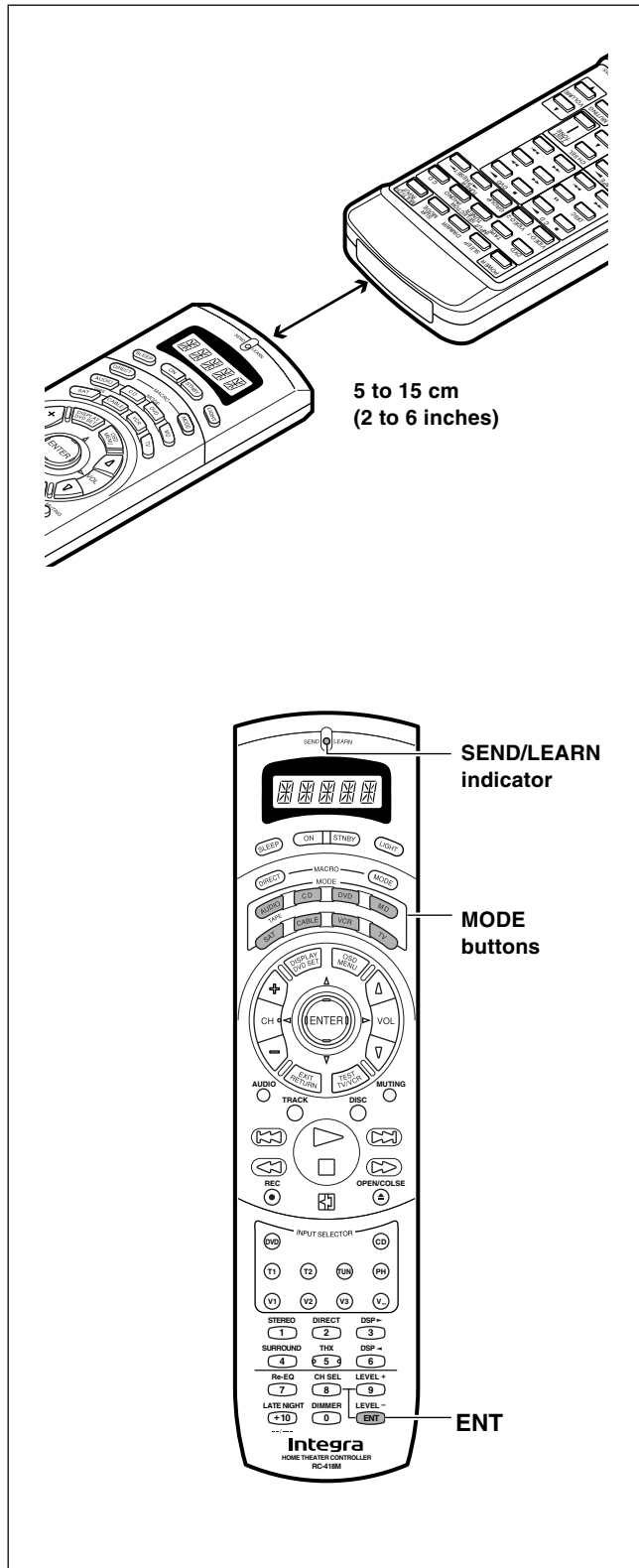

1. Place the remote controller and the remote controller for the other device facing each other at a distance of 5 to 15 cm (2 to 6 inches) apart.

2. While pressing and holding down the desired MODE button on the remote controller, press the ENT button and then release both buttons.

When you press and hold down the MODE button, the SEND/LEARN indicator lights. When you press the ENT button, the lamp turns off. When you release the buttons, the lamp lights again and "LEARN" appears in the display.

3. Press and release the button on the remote controller to which you want to transfer the next command.

You may select any button but the eleven ones indicated in the figure below. When you press the button, "RCV" appears in the display and the SEND/LEARN indicator turns off. When you release the button, the indicator lights again.

If you press the wrong button by mistake, press that same button again. The SEND/LEARN indicator flashes twice, "CLEAR" appears in the display, and the remote controller exits the programming mode.

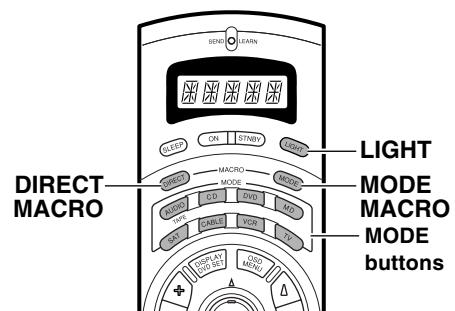

■: Buttons that cannot be programmed.

Programming the commands of remote controllers for other devices into the remote controller

- 4. Press and hold down the button (that corresponds to the command you are programming) on the remote controller of the other device until the SEND/LEARN lamp on the remote controller flashes twice and “SAVED” appears in the display.**

After flashing twice, the SEND/LEARN indicator will light again and “LEARN” appears in the display.

- 5. Repeat Steps 3 and 4 to transfer all the commands you desire from the other remote controller and program them to buttons on the remote controller under the same MODE.**

Repeat Steps 2 through 4 to program commands to a different MODE (e.g., when programming from a different remote controller).

- 6. Press the MODE button that you pressed in step 2 to complete the programming.**

- 7. Operate the newly programmed buttons to make sure the learning function was performed properly.**

Notes:

- The remote controller codes for Onkyo compact disc players, cassette tape decks, DVD players, and mini disc recorder have already been programmed into buttons on the remote controller. You may, however, use these buttons to program the codes for other remote controllers. If you wish to restore the Onkyo preset codes after you program new codes, you must first erase the new codes (see page 63).
- The remote controller has 408 memory slots (8 modes x 51 buttons). Some remote controllers may have more commands that can be remembered by the remote controller. In such cases, it will be necessary for you to determine which commands are more important than others.
- If no button is pressed for more than 30 seconds during the programming, or if you perform an invalid operation during programming, the SEND/LEARN indicator flashes three times quickly, “ERROR” appears in the display, and the remote controller exits the programming mode. Resume from Step 2.
- If a failure occurs during programming, the SEND/LEARN indicator flashes three times quickly, “NG” appears in the display, and the remote controller exits the programming mode. Resume from Step 3.
- If a failure occurs five times in row during programming, “ERROR” appears in the display, and the remote controller exits the programming mode. Resume from Step 3.
- If you try to program beyond the learning capacity of the remote controller, the SEND/LEARN indicator flashes six times quickly, “FULL” appears in the display, and the remote controller exits the programming mode. Try programming under a different MODE button.
- When you want to program a command to a button to which you have already programmed a command, simply follow the same procedure given and programming for that button will be overwritten.
- The remote controller uses infrared rays to send its commands, as do most other remote controllers. Though most remote controller codes can be memorized by the remote controller, be aware that some remote controllers use a system that is quite different from the remote controller and therefore may not be able to be programmed.
- Some remote controllers have a single button that performs multiple functions (for example, the function may change each time the button is pressed). If this is the case, each function must be programmed to a separate button on the remote controller.
- Once you have transferred the commands from the other remote controller, refer to the instruction manual that came with that product for instructions on how to operate that product.
- Make sure both the remote controller and the other remote controller have new batteries. If either of them has batteries that are low, you may not be able to program the commands of the other remote controller properly into the remote controller.

See page 67 for how to erase the memorized commands from all buttons.

Programming the commands of remote controllers for other devices into the remote controller

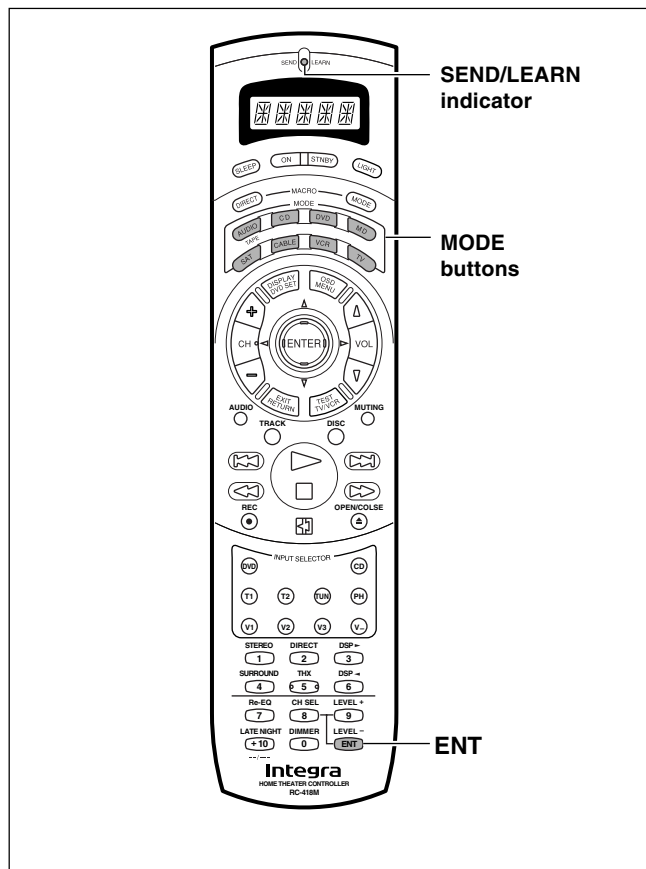

Erasing the programmed command from one button

You can only erase memorized commands and not preset ones.

1. **Press and hold down the desired MODE button for the command, press the ENT button, and then release both buttons.**

When you press the MODE button, the SEND/LEARN indicator lights and that mode appears in the display. When you press the ENT button, the lamp turns off. When you release the buttons, the lamp lights again and "LEARN" appears in the display.

2. **Press and release the button for the command you wish to erase.**

When you press the button, the SEND/LEARN indicator turns off and "RCV" appears in the display. When you release the button, the lamp lights again.

3. **Press and release the same button again.**

The SEND/LEARN lamp flashes twice slowly and "CLEAR" appears in the display. The memorized command is erased.

Note:

If no button is pressed for more than 30 seconds during the programming, the SEND/LEARN indicator flashes three times quickly, "ERROR" appears in the display, and the remote controller exits the programming mode. Resume from Step 1.

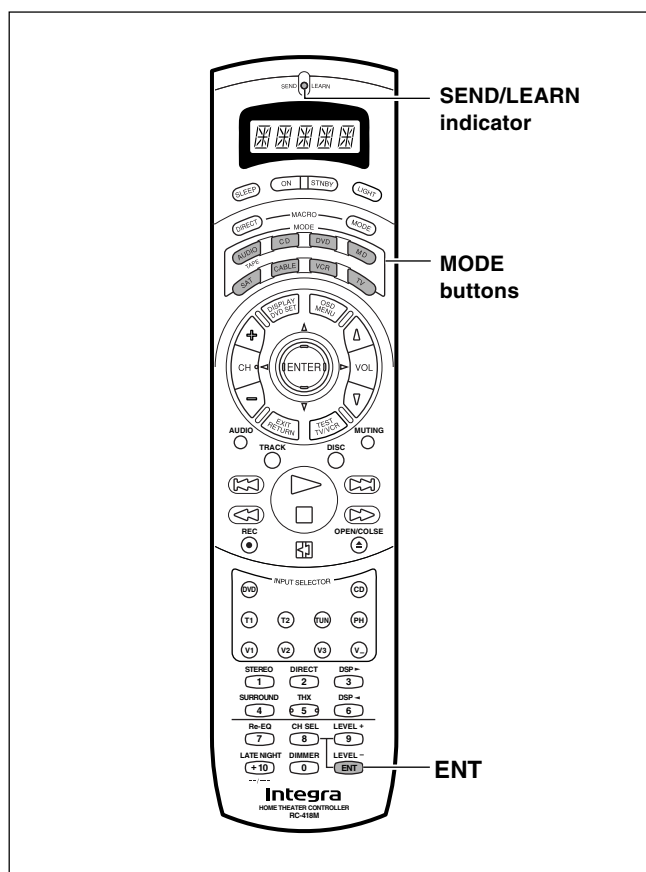

Erasing all the commands programmed under a MODE button

1. **Press and hold down the desired MODE button, press the ENT button twice, and then release both buttons.**

When you press the MODE button, the SEND/LEARN indicator lights and that mode appears in the display. When you press the ENT button, the lamp turns off. When you release the buttons, the lamp flashes twice slowly and then lights again.

2. **Press and release the same MODE button again.**

When you release the button, the SEND/LEARN indicator flashes twice slowly. This erases all the commands memorized to the MODE button.

Notes:

- If no button is pressed for more than 30 seconds during the programming, the SEND/LEARN indicator flashes three times quickly and the remote controller exits the programming mode. Resume from Step 1.
- If you perform an invalid operation during programming, the SEND/LEARN indicator flashes three times quickly, "ERROR" appears in the display, and the remote controller exits the programming mode. Resume from Step 1.
- If many commands have been programmed to the MODE button, then the SEND/LEARN indicator may remain lit for some time during Step 2. This is not a malfunction.

Using a Macro function

What is a Macro function?

A Macro function enables you to program a series of button operations (up to 16) on the remote controller into a single button. For example, to play a compact disc player connected to the DTR-7.1 normally, you must perform the following steps:

1. Press the **AUDIO/TAPE MODE** button.
2. Press the **ON** button.
3. Press the **CD (INPUT SELECTOR)** button.
4. Press the **CD MODE** button.
5. Press the **playback** button.

By using the macro function, you can perform the above five operations by **only pressing two buttons**.

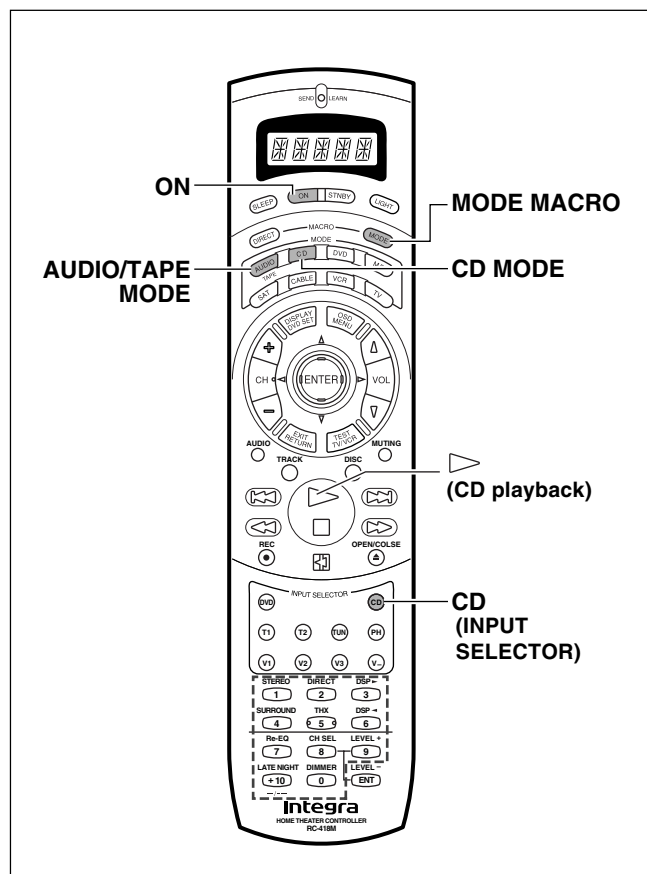

Tip:

- If you erase or change the command of a button programmed in a macro, that operation of that button will no longer work in the macro. In this case, it will be necessary for you to reprogram the macro in order to avoid incorrect operation.
- The codes programmed into a macro will be transmitted at an interval of 0.5 seconds. However, some devices may not be able to complete one operation in 0.5 seconds and may miss the next code. In this case, after pressing one operation button, you can press the same MODE button again before pressing the next operation button to add another 0.5 seconds between the two operations.

Programming a Macro function

You can program a different macro into the MODE MACRO button for each of the eight MODE buttons. The macro is then executed by pressing the appropriate MODE button and then pressing the MODE MACRO button. For example, to program the macro described above into the CD MODE button, perform the steps given below.

1. Press and hold down the desired **MODE** button (in this case, the **CD MODE** button), press the **MODE MACRO** button, and then release both buttons.

When you press the CD MODE button, the SEND/LEARN indicator lights and "CD" appears in the display. When you press the MODE MACRO button, the indicator turns off. When you release the buttons, the indicator flashes and lights again and "M 01" appears in the display.

2. Press the operation buttons you wish to program in order (in this case, press **AUDIO/TAPE MODE** → **ON** → **CD (INPUT SELECTOR)** → **CD MODE** → **playback** button).

When you press each button, the SEND/LEARN indicator turns off and the display changes from "M 01" → "M 02" → "M 03" → etc. When you release the button, the indicator lights.

3. Press the **MODE MACRO** button to complete the programming.

The SEND/LEARN indicator flashes twice slowly and "SAVED" appears in the display.

4. Run the macro to check to see if the macro has been properly programmed.

Notes:

- You may program up to 16 button operations into each macro function. If you try to program a 17th operation, it will be ignored, "SAVED" appears in the display, and programming is stopped.
- If no button is pressed for more than 30 seconds during the programming, the SEND/LEARN indicator flashes three times quickly, "ERROR" appears in the display, and the remote controller exits the programming mode. Resume from Step 1.
- If you perform an invalid operation during programming, the SEND/LEARN indicator flashes three times quickly, "ERROR" appears in the display, and the remote controller exits the programming mode. Resume from Step 1.

Running a Macro function

Perform the procedure below to run a macro function that you have programmed into the remote controller. After programming a macro, you should always run it at least once to make sure that it has been programmed properly.

1. Point the remote controller at the DTR-7.1 and press the **CD MODE** button.
2. Press the **MODE MACRO**, and verify that the devices operate properly.

It may take a while for the macro to finish transmitting, so be sure to continue pointing the remote controller at the device until the SEND/LEARN indicator turns off.

Using a Macro function

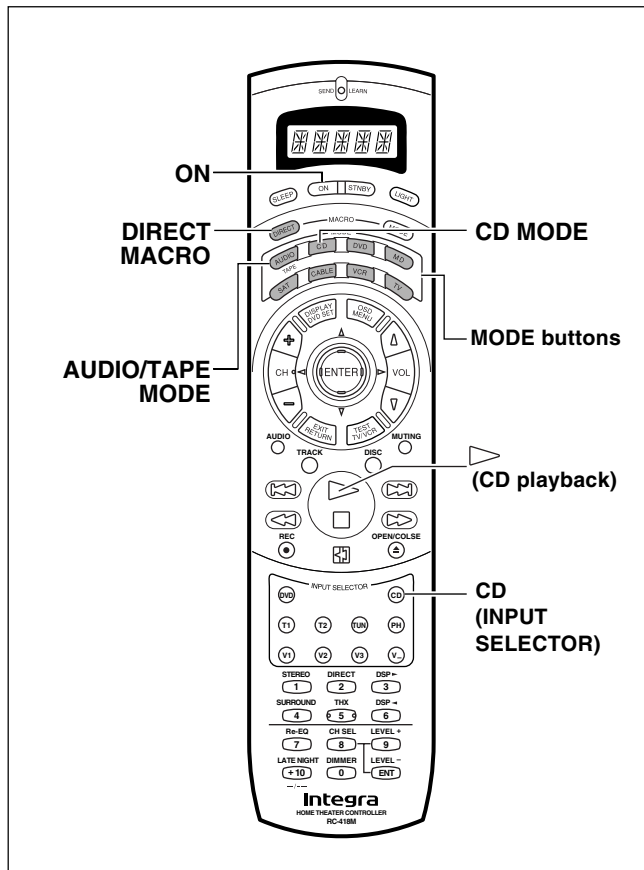

Tip:

- If you erase or change the command of a button programmed in the direct macro, that operation of that button will no longer work in the macro. In this case, it will be necessary for you to reprogram the direct macro in order to avoid incorrect operation.
- The codes programmed into a direct macro will be transmitted at an interval of 0.5 seconds. However, some devices may not be able to complete one operation in 0.5 seconds and may miss the next code. In this case, after pressing one operation button, you can press the same MODE button again before pressing the next operation button to add another 0.5 seconds between the two operations.

Programming the Direct Macro function

With the direct macro function, you can program a series of button operations as a macro into the DIRECT MACRO button so the macro can be executed with just one touch. Note that for the direct macro function, only one macro can be programmed. For example, to program the macro described on the previous page for the DIRECT MACRO button, perform the steps given below.

1. Press and hold down any one of the eight MODE buttons, press the DIRECT MACRO button, and then release both buttons.

When you press the MODE button, the SEND/LEARN indicator lights and that mode appears in the display. When you press the DIRECT MACRO button, the indicator turns off. When you release the buttons, the indicator flashes briefly and then lights again and "M 01" appears in the display.

2. Press the operation buttons you wish to program in order (in this case, press AUDIO/TAPE MODE → ON → CD (INPUT SELECTOR) → CD MODE → playback button).

When you press each button, the SEND/LEARN indicator turns off and the display changes from "M 01" → "M 02" → "M 03" → etc. When you release the button, the indicator lights.

3. Press the DIRECT MACRO button to complete the procedure.

The SEND/LEARN indicator flashes twice slowly and "SAVED" appears in the display.

4. Check to see if the macro has been properly programmed.

Notes:

- You may program up to 16 button operations into each macro function. If you try to program a 17th operation, it will be ignored, "SAVED" appears in the display, and programming is stopped.
- If no button is pressed for more than 30 seconds during the programming, the SEND/LEARN indicator flashes three times quickly, "ERROR" appears in the display, and the remote controller exits the programming mode. Resume from Step 1.
- If you perform an invalid operation during programming, the SEND/LEARN indicator flashes three times quickly, "ERROR" appears in the display, and the remote controller exits the programming mode. Resume from Step 1.

Running a Direct Macro function

Perform the procedure below to run a direct macro function that you have programmed into the remote controller. After programming a direct macro, you should always run it at least once to make sure that it has been programmed properly.

1. Point the remote controller at the DTR-7.1 and press the DIRECT MACRO button.

It may take a while for the macro to finish transmitting, so be sure to continue pointing the remote controller at the device until the SEND/LEARN indicator turns off.

Using a Macro function

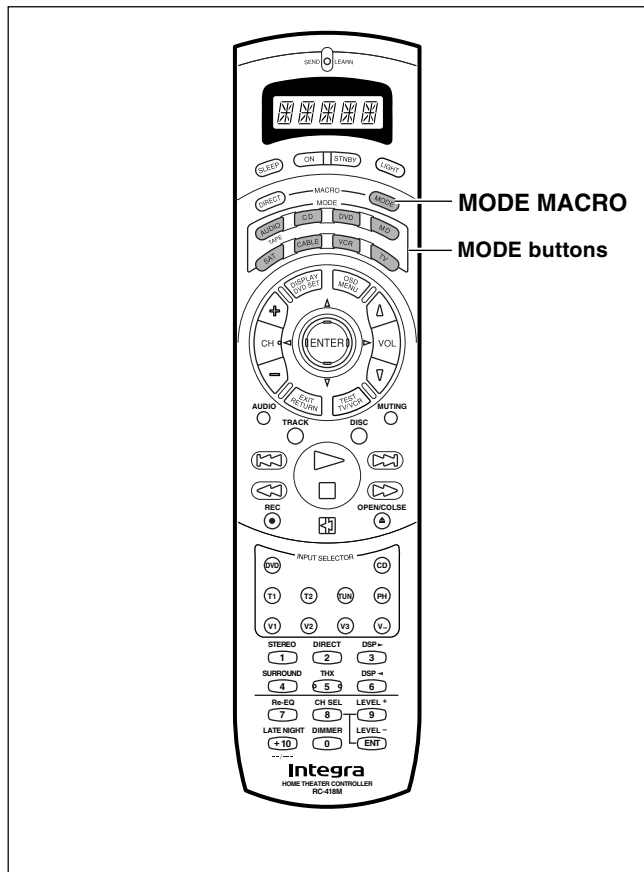

Erasing a macro from the MODE MACRO button

1. Press and hold down the desired **MODE** button, press the **MODE MACRO** button, and then release both buttons.

When you press the MODE button, the SEND/LEARN indicator lights and that mode appears in the display. When you press the MODE MACRO button, the indicator turns off. When you release the buttons, the indicator flashes once and "M 01" appears in the display.

2. Press the **MODE MACRO** button again.

The SEND/LEARN indicator flashes twice slowly and "CLEAR" appears in the display. The macro programmed to the MODE button pressed in Step 1 above is erased.

Note:

- If no button is pressed for more than 30 seconds during the programming, the SEND/LEARN indicator flashes three times quickly, "ERROR" appears in the display, and the remote controller exits the programming mode. Resume from Step 1.
- Be aware that if you press a button other than MODE MACRO button in Step 2, then you will in effect be overwriting the previous macro with a new macro.

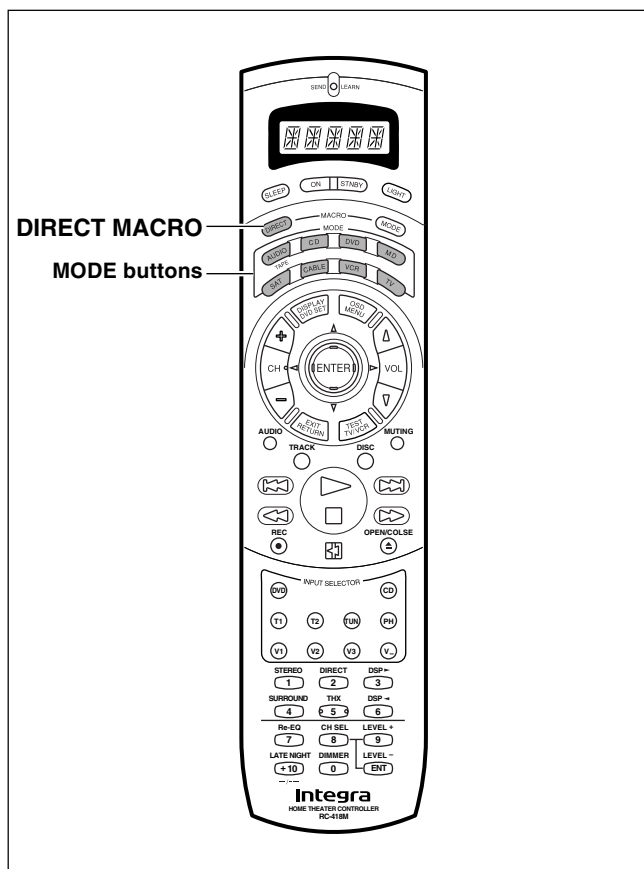

Erasing a direct macro from the DIRECT MACRO button

1. Press and hold down any one of the eight **MODE** buttons, press the **DIRECT MACRO** button, and then release both buttons.

When you press the MODE button, the SEND/LEARN indicator lights and that mode appears in the display. When you press the DIRECT MACRO button, the indicator turns off. When you release the buttons, the indicator flashes once and "M 01" appears in the display.

2. Press the **DIRECT MACRO** button again.

The SEND/LEARN indicator flashes twice slowly and "CLEAR" appears in the display. The macro programmed to the DIRECT MACRO button is erased.

Note:

- If no button is pressed for more than 30 seconds during the programming, the SEND/LEARN indicator flashes three times quickly, "ERROR" appears in the display, and the remote controller exits the programming mode. Resume from Step 1.
- Be aware that if you press a button other than DIRECT MACRO button in Step 2, then you will in effect be overwriting the previous direct macro with a new direct macro.

Using a Macro function

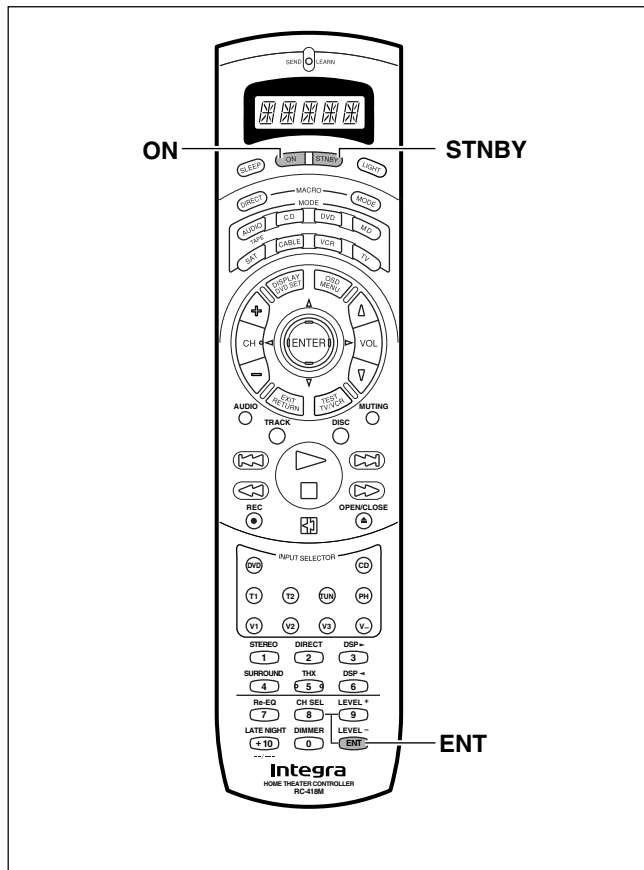

Erasing all commands and macros that have been programmed

This procedure will erase all the commands and macros that you have programmed into the remote controller and return it to its default settings. This operation will not affect the preset settings of the remote controller.

1. **Open the battery cover and remove the batteries from the remote controller.**
2. **While pressing and holding down the ON and STNBY buttons, re-insert the batteries in their correct orientation, and then release both buttons.**

The SEND/LEARN indicator flashes slowly and "CLEAR" appears in the display.

3. **Press the ENT button.**

The SEND/LEARN indicator lights up for about ten seconds and then turns off and "AUDIO" appears in the display.

All programmed commands and macros are erased and the remote controller returns to its factory presets.

Notes:

- Proceed to Step 3 immediately after Step 2; otherwise, the batteries will be consumed quickly.
- If you press any button other than the ENT button in Step 3, nothing will be erased. In this case, resume from Step 1.

Macro mode programming memo:

MACRO	MODE MACRO	MODE MACRO	MODE MACRO	MODE MACRO	MODE MACRO	MODE MACRO	MODE MACRO	MODE MACRO	DIRECT MACRO
	↓ AUDIO	↓ CD	↓ DVD	↓ MD	↓ SAT	↓ CABLE	↓ VCR	↓ TV	
Operation 1									
Operation 2									
Operation 3									
Operation 4									
Operation 5									
Operation 6									
Operation 7									
Operation 8									
Operation 9									
Operation 10									
Operation 11									
Operation 12									
Operation 13									
Operation 14									
Operation 15									
Operation 16									

Troubleshooting guide

If a problem occurs while you are using the remote controller, first try to operate the controls on the front panel of the DTR-7.1 to make sure that it is not due to a malfunction (or worn out batteries) in the remote controller.

POWER

Power shuts off immediately after power on.

- Amplifier protection circuitry has been activated.
 - Remove the power cord from outlet immediately. Contact your Integra/Onkyo authorized service center.

No power.

- Power cord is disconnected.
 - Connect power cord.
- External noise is affecting the internal microcomputer.
 - Turn the power button off and then on again or remove the power cord from the outlet and then plug it in again.
- Internal fuse is blown.
 - Contact your Integra/Onkyo authorized Service Center.

Power turns on but no sound.

- “Muting” is displayed.
 - Press the MUTING button on the remote controller to turn it off.
- Bad connections or wiring.
 - Check connections, speaker cables, etc.
- Amplifier protection circuitry has been activated.
 - Contact your Integra/Onkyo authorized Service Center.

The sound of the playback source is not heard.

- Input selector is not set properly.
 - Set to correct input source.
- Headphones are connected.
 - Lower volume and then disconnect headphones.

SPEAKERS

No sound from the center speaker, or at very low volume.

- Speaker cable is not connected.
 - Check the connection between the amplifier and the speaker.
- Listening mode is set to Stereo or Direct.
 - Set the Listening mode to any mode other than Stereo or Direct. The output to the center speaker may differ depending on the listening mode.
- CENTER level is set to minimum.
 - Set the CENTER level to the appropriate volume (page 32).
- CENTER SPEAKER is set to “None.”
 - Set CENTER SPEAKER to “Large” or “Small” (page 30).

No sound or very low volume from subwoofer

- Subwoofer is set to “No.”
 - Check the speaker setting (page 30).
- Subwoofer speakers output level setting is improper.
 - Check the output level of the Subwoofer using the test tone.

Low frequency humming is heard

- Not properly grounded.
 - Check outer conductor of input plugs.
- Turntable motor is not properly grounded.
 - Check for proper ground connection.
- Audio connection cables on the rear panel are connected incorrectly.
 - Adjust the placement of the cable to reduce hum.

Howling is heard when the volume is turned up.

- Turntable and speakers are located too close together.
 - Move them farther apart.

Rough or scratchy sound is heard. High range is not clear.

- The needles of turntable is dirty or worn, or a problem exists with a connected component.
 - Refer to the instruction of the connected components and check for problem.
- Treble control too high.
 - Turn treble down.

No sound is output from the surround back speakers.

- The setting for the surround back speakers does not match the actual configuration.
 - Check the Surr Back Out setting (OSD Menu Speaker Setup → Speaker Config). If one surround back speaker is connected, select “1 ch,” and if two surround back speakers are connected, select “2 ch” (page 30).
- Check the parameter settings.
 - If the Dolby D 6.1/DTS-ES setting is “Off,” there is no output to the surround back speakers.
Change the setting to “Auto” or “On.” (However, there may be no output depending on the software being played. For more details, see page 43.)
 - If the Dolby D THX Surround EX/DTS THX Surround EX setting is “Off,” there is no output to the surround back speakers.
Change the setting to “Auto” or “On.” (However, there may be no output depending on the software being played. For more details, see page 43.)

Troubleshooting guide

FM/AM TUNER

AM stations cannot be received.

- AM loop antenna is not connected.
 - Connect the included AM loop antenna to the AM antenna terminals.

Buzzing noise on AM stations (particularly noticeable at night or with weak stations).

- Noise from electrical apparatus such as fluorescent lamp.
 - Move the AM loop antenna to different position.
 - Set up an outdoor AM antenna.

Noise is heard at high-pitched sounds on AM stations.

- Noise from TV set.
 - Place the AM loop antenna as far as possible from the TV.
 - Move unit away from TV set.

Crackling noise on both AM and FM stations

- Noise caused by fluorescent lamp being turned on and off.
 - Move antenna as far as possible from the fluorescent lamp.
- Noise from automobile ignition.
 - Install an FM outdoor antenna as far as possible from the road.
 - Change the position or direction of the outdoor antenna.

The indicators light for stereo reception, but sound is distorted and stereo separation is bad.

- Station is too strong.
 - Change to FM indoor antenna.
- Multiple reflection of the radio waves because of tall buildings or mountains.
 - Use antenna that has better directivity and select a point where distortion is least.

Indicators for stereo reception flicker and hiss is heard on FM stations.

- Station is too weak.
 - Install an outdoor FM antenna.
- Stereo FM broadcasts cover only about half the distance of an ordinary broadcast.
 - Change the position or direction of the outdoor antenna.

No preset station is recalled.

- Power cord has been unplugged or the POWER switch has been turned off for a long time.
 - The memory contents are lost. Store all stations again.

VIDEO and AUDIO

Desired picture does not appear.

- Improper connection.
 - Check the connection again. Insert the plugs and connectors completely.
- Video Setup sub-menu of Input Setup menu settings are incorrect.
 - Check Settings.

No OSD Menu display.

- Improper connection.
 - Check connections.
- OSD Menu is displayed when monitor is connected to VIDEO or S VIDEO of MONITOR OUT.
 - Confirm connections.
- Monitor is connected to MONITOR OUT VIDEO when the OSD output is set to "S Video" or monitor is connected to MONITOR OUT S VIDEO when the OSD output is set to "Video."
 - Check the OSD Config sub-menu of OSD Setup (page 29).

Picture and sound do not match.

- Improper connection.
 - Check connections.
- Video Setup sub-menu of Input Setup menu settings are incorrect.
 - Check settings.

No sound, or sound of the selected source is not heard.

- Digital Setup sub-menu of Input Setup menu settings are incorrect.
 - Check settings.

No picture appears on the TV screen (or monitor).

- TV (or monitor) is not set to receive the output signals from the receiver.
 - Set the TV (or monitor) to the receiver input.
- Video cable is not connected securely.
 - Check connections.
- S VIDEO IN signal is output at VIDEO OUT and S VIDEO OUT, but VIDEO IN signal is only output at VIDEO OUT. Also, COMPONENT VIDEO IN signal is only output at COMPONENT VIDEO OUT.
 - Check the input and output signals.

Troubleshooting guide

REMOTE CONTROLLER

Front panel controls function but remote controller controls do not.

- No batteries in remote controller.
→ Insert batteries.
- Batteries have worn out.
→ Replace batteries.
- Remote controller is not pointed at the remote sensor of the DTR-7.1.
→ Point the remote controller at the remote sensor of the DTR-7.1.
- Remote controller is too far from the DTR-7.1.
→ Operate the remote controller within 16 feet.
- Remote controller is functioning in a different mode
→ Press the AUDIO MODE button.

OTHER

LATE NIGHT function cannot be used.

- Playback source is not Dolby Digital encoded.
→ Check that the DOLBY DIGITAL indicator lights up on the display.

Re-EQ function cannot be used.

- Listening mode is set to “Stereo,” “Theater-Dimensional” or “Direct.”
→ See table on page 44.

Parameter cannot be set for Front Effect, Room Size, etc.

- Parameter may not be able to be set depending on the listening mode.
→ See table on page 44.

Multichannel audio is not output.

- To listen to multichannel audio, “Yes” must be selected in the Multichannel sub-menu in the Input Setup menu. Also, it is necessary to select Multichannel with the Audio Selector button.
→ Check that the component is connected to the MULTI CHANNEL INPUT port and check the OSD Menu settings.

Components in remote zone (Zone 2) do not operate properly.

- Components are incorrectly connected.
→ Check connections.
- Objects are interfering with remote controller signals.
→ Move interfering objects (e.g. fluorescents) away from path of remote controller signals.

For digital sources, sound is sometimes not output depending on media type.

- Format of digital input source is fixed. Other digital formats will not be output.
→ Set Digital Format to “All” in the Audio Setup sub-menu of the Input Setup menu (page 35).

For DTS and PCM sources, noises or incorrect starts occur when the digital source is played.

- Digital Format settings is incorrect.
→ Try setting Digital Format to the same as the input source in the Audio Setup sub-menu of the Input Setup menu (page 35).

Operation of fan is heard.

- DTR-7.1 is equipped with internal ventilation fan to prevent overheating. This is not a malfunction.

Also refer to the respective instruction manuals of the compact disc player, DVD player, video cassette recorder, TV monitor, etc., that compose your entertainment system.

The DTR-7.1 contains an internal microcomputer that performs high-level operations. However, on extremely rare occasions, noise or interference from an external source or static electricity may cause faulty operation. If this occurs, unplug the power cord from the wall outlet, wait five or more seconds, and then plug it back in. This should correct the situation.

*To reset the surround mode and other settings to the factory default settings, hold down the VIDEO 1 button with the DTR-7.1 turned on and then press the REC OUT button. “CLEAR” appears in the front display and the DTR-7.1 enters the standby state.

Specifications

AMPLIFIER SECTION

Continuous Average Power output (FTC)

All channels: 100 W per channel min. RMS at 8 , 2 channels driven from 20 Hz to 20 kHz with no more than 0.08% total harmonic distortion. 130 W per channel min. RMS at 6 , 2 channels driven from 1 kHz with no more than 0.1% total harmonic distortion.

Continuous Power output (DIN)	135 W at 6
Maximum Power output (EIAJ)	160 W at 6
Dynamic Power Output (Stereo)	2 × 250 W at 3 2 × 210 W at 4 2 × 130 W at 8
Total Harmonic Distortion:	0.08% at rated power 0.08% at 1 W output
IM Distortion:	0.08% at rated power 0.08% at 1 W output
Damping Factor:	60 at 8
Input Sensitivity and Impedance	
PHONO:	2.5 mV, 50 k
LINE (CD, TAPE, DVD, VIDEO 1-4):	200 mV, 50 k
MULTICHANNEL INPUT (FRONT L/C/R, SURROUND L/R, SURROUND BACK L/R):	200 mV, 50 k
(SUBWOOFER):	36 mV, 50 k
COAXIAL 1, 2 (DIGITAL):	0.5 Vp-p, 75
DVD, VIDEO1-4:	1 Vp-p, 75 1 Vp-p, 75 (Y) 0.28 Vp-p, 75 (C)
COMPONENT VIDEO 1, 2:	1 Vp-p, 75 (Y) 0.7 Vp-p, 75 (P B, PR)
Output Level and Impedance	
Rec out (TAPE, VIDEO 1, 2):	200 mV, 2.2 k
Pre out:	1 V, 470
ZONE2 OUT:	100 mV, 470
VIDEO (VIDEO 1, 2, MONITOR OUT):	1 Vp-p, 75 1 Vp-p, 75 (Y) 0.28 Vp-p, 75 (C)
COMPONENT VIDEO OUT:	1 Vp-p, 75 (Y) 0.7 Vp-p, 75 (P B, PR)
Phono Overload:	110 mV RMS at 1 kHz, 0.5% T.H.D.
Frequency Response:	20 Hz to 30 kHz: ±1 dB (CD in Direct mode) 5 Hz to 100 kHz: +1 dB,-3 dB (CD in Direct mode)
RIAA Deviation:	20 to 20 kHz : ±0.8 dB
Tone Control	
Bass:	±10 dB at 100 Hz
Treble:	±10 dB at 10 kHz
Signal-to-Noise Ratio (Stereo)	
Phono:	80 dB (IHF A, 5 mV input)
CD/Tape:	100 dB (IHF A, 0.5 V input)
Muting:	-50 dB

TUNER SECTION

FM

Tuning Range:	87.5 to 108.0 MHz (50-kHz steps)
Usable Sensitivity	
Mono:	11.2 dBf, 1.0 μV (75 IHF) 0.9 μV (75 DIN)
Stereo:	17.2 dBf, 2.0 μV (75 IHF) 23 μV (75 DIN)
50 dB Quieting Sensitivity	
Mono:	17.2 dBf, 2.0 μV (75)
Stereo:	37.2 dBf, 2.0 μV (75)
Capture Ratio:	2.0 dB
Image Rejection Ratio:	40 dB
IF Rejection Ratio:	90 dB
Signal-to-Noise Ratio	
Mono:	76 dB
Stereo:	70 dB
Alternate Channel Attenuation:	55 dB
Selectivity:	50 dB (DIN)
AM Suppression Ratio:	50 dB
Total Harmonic Distortion	
Mono:	0.2%
Stereo:	0.3%
Frequency Response:	30 Hz to 15 kHz, ±1.0 dB
Stereo Separation:	45 dB at 1 kHz 30 dB at 100 Hz to 10 kHz

AM

Tuning Range:	530 to 1,710 kHz (10 kHz steps)
Usable Sensitivity:	30 μV
Image Rejection Ratio:	40 dB
IF Rejection Ratio:	40 dB
Signal-to-Noise Ratio:	40 dB
Total Harmonic Distortion:	0.7%

GENERAL

Power Supply:	AC 120 V, 60 Hz
Power Consumption:	5.5 A
Dimensions (W × H × D):	17-1/8" × 6-7/8" × 18-1/8"
Weight:	36.4 lbs.

REMOTE CONTROLLER

Transmitter:	Infrared
Signal range:	Approx. 16 ft.
Power supply:	Two "AA" batteries (1.5 V × 2)

Specifications and features are subject to change without notice.

Integra Division of
ONKYO U.S.A. CORPORATION
200 Williams Drive, Ramsey, N.J. 07446, U.S.A.
Tel: 201-825-7950 Fax: 201-825-8150 E-mail: integra@onkyousa.com

Integra Division of
ONKYO CORPORATION
Sales & Product Planning Div. : 2-1, Nisshin-cho, Neyagawa-shi, OSAKA 572-8540, JAPAN
Tel: 072-831-8111 Fax: 072-833-5222

SN 29342973



Free Manuals Download Website

<http://myh66.com>

<http://usermanuals.us>

<http://www.somanuals.com>

<http://www.4manuals.cc>

<http://www.manual-lib.com>

<http://www.404manual.com>

<http://www.luxmanual.com>

<http://aubethermostatmanual.com>

Golf course search by state

<http://golfingnear.com>

Email search by domain

<http://emailbydomain.com>

Auto manuals search

<http://auto.somanuals.com>

TV manuals search

<http://tv.somanuals.com>