

Integra

AV Receiver

DTR-8.2

Instruction Manual

Thank you for purchasing the **Integra** AV Receiver. Please read this manual thoroughly before making connections and plugging in the unit. Following the instructions in this manual will enable you to obtain optimum performance and listening enjoyment from your new AV Receiver. Please retain this manual for future reference.

Contents

Before using 2

Facilities and connections 8

Setup and operation 29

Remote controller 59

Appendix 86

WARNING:

TO REDUCE THE RISK OF FIRE OR ELECTRIC SHOCK, DO NOT EXPOSE THIS APPLIANCE TO RAIN OR MOISTURE.

CAUTION:

TO REDUCE THE RISK OF ELECTRIC SHOCK, DO NOT REMOVE COVER (OR BACK). NO USER-SERVICEABLE PARTS INSIDE. REFER SERVICING TO QUALIFIED SERVICE PERSONNEL.



WARNING
RISK OF ELECTRIC SHOCK
DO NOT OPEN

AVIS
RISQUE DE CHOC ELECTRIQUE
NE PAS OUVRIR



The lightning flash with arrowhead symbol, within an equilateral triangle, is intended to alert the user to the presence of uninsulated "dangerous voltage" within the product's enclosure that may be of sufficient magnitude to constitute a risk of electric shock to persons.



The exclamation point within an equilateral triangle is intended to alert the user to the presence of important operating and maintenance (servicing) instructions in the literature accompanying the appliance.

Important Safeguards

1. **Read Instructions** – All the safety and operating instructions should be read before the appliance is operated.
2. **Retain Instructions** – The safety and operating instructions should be retained for future reference.
3. **Heed Warnings** – All warnings on the appliance and in the operating instructions should be adhered to.
4. **Follow Instructions** – All operating and use instructions should be followed.
5. **Cleaning** – Unplug the appliance from the wall outlet before cleaning. The appliance should be cleaned only as recommended by the manufacturer.
6. **Attachments** – Do not use attachments not recommended by the appliance manufacturer as they may cause hazards.
7. **Water and Moisture** – Do not use the appliance near water –for example, near a bath tub, wash bowl, kitchen sink, or laundry tub; in a wet basement; or near a swimming pool; and the like.
8. **Accessories** – Do not place the appliance on an unstable cart, stand, tripod, bracket, or table. The appliance may fall, causing serious injury to a child or adult, and serious damage to the appliance. Use only with a cart, stand, tripod, bracket, or table recommended by the manufacturer, or sold with the appliance. Any mounting of the appliance should follow the manufacturer's instructions, and should use a mounting accessory recommended by the manufacturer.
9. An appliance and cart combination should be moved with care. Quick stops, excessive force, and uneven surfaces may cause the appliance and cart combination to overturn.
10. **Ventilation** – Slots and openings in the cabinet are provided for ventilation and to ensure reliable operation of the appliance and to protect it from overheating, and these openings must not be blocked or covered. The openings should never be blocked by placing the appliance on a bed, sofa, rug, or other similar surface. The appliance should not be placed in a built-in installation such as a bookcase or rack unless proper ventilation is provided. There should be free space of at least 20 cm (8 in.) and an opening behind the appliance.
11. **Power Sources** – The appliance should be operated only from the type of power source indicated on the marking label. If you are not sure of the type of power supply to your home, consult your appliance dealer or local power company.
12. **Grounding or Polarization** – The appliance may be equipped with a polarized alternating current line plug (a plug having one blade wider than the other). This plug will fit into the power outlet only one way. This is a safety feature. If you are unable to insert the plug fully into the outlet, try reversing the plug. If the plug should still fail to fit, contact your electrician to replace your obsolete outlet. Do not defeat the safety purpose of the polarized plug.
13. **Power-Cord Protection** – Power-supply cords should be routed so that they are not likely to be walked on or pinched by items placed upon or against them, paying particular attention to cords at plugs, convenience receptacles, and the point where they exit from the appliance.
14. **Outdoor Antenna Grounding** – If an outside antenna or cable system is connected to the appliance, be sure the antenna or cable system is grounded so as to provide some protection against voltage surges and built-up static charges. Article 810 of the National Electrical Code, ANSI/NFPA 70, provides information with regard to proper grounding of the mast and supporting structure, grounding of the lead-in wire to an antenna-discharge unit, size of grounding conductors, location of antenna-discharge unit, connection to grounding electrodes, and requirements for the grounding electrode. See Figure 1.
15. **Lightning** – For added protection for the appliance during a lightning storm, or when it is left unattended and unused for long periods of time, unplug it from the wall outlet and disconnect the antenna or cable system. This will prevent damage to the appliance due to lightning and power-line surges.
16. **Power Lines** – An outside antenna system should not be located in the vicinity of overhead power lines or other electric light or power circuits, or where it can fall into such power lines or circuits. When installing an outside antenna system, extreme care should be taken to keep from touching such power lines or circuits as contact with them might be fatal.
17. **Overloading** – Do not overload wall outlets, extension cords, or integral convenience receptacles as this can result in a risk of fire or electric shock.
18. **Object and Liquid Entry** – Never push objects of any kind into the appliance through openings as they may touch dangerous voltage points or short-out parts that could result in a fire or electric shock. Never spill liquid of any kind on the appliance.
19. **Servicing** – Do not attempt to service the appliance yourself as opening or removing covers may expose you to dangerous voltage or other hazards. Refer all servicing to qualified service personnel.
20. **Damage Requiring Service** – Unplug the appliance from the wall outlet and refer servicing to qualified service personnel under the following conditions:
 - A. When the power-supply cord or plug is damaged,
 - B. If liquid has been spilled, or objects have fallen into the appliance,
 - C. If the appliance has been exposed to rain or water,
 - D. If the appliance does not operate normally by following the operating instructions. Adjust only those controls that are covered by the operating instructions as an improper adjustment of other controls may result in damage and will often require extensive work by a qualified technician to restore the appliance to its normal operation,
 - E. If the appliance has been dropped or damaged in any way, and
 - F. When the appliance exhibits a distinct change in performance – this indicates a need for service.

PORTABLE CART WARNING



S3125A

Contents

Before using

Important Safeguards	2
Precautions	3
Contents	4
Features	6
Supplied accessories	6
Before using this unit	7
Insert batteries	7
Using the remote controller	7

Facilities and connections

Front panel facilities	8
Remote controller	11
Rear panel facilities	14
Connections	18
Connecting your audio components	18
Connecting your video components	19
Connecting speakers	22
Ideal speaker configuration	22
Minimum speaker configuration for surround sound playback	22
Speaker placement	22
Connecting speakers	23
Connecting the speaker cable	23
Connecting a subwoofer	23
Connecting the remote zone (Zone 2) speakers	24
Outline	24
When using the SURR BACK/ZONE 2 SPEAKERS terminals ..	24
When using the SURR BACK/ZONE 2 PRE OUT terminals ..	24
When using the ZONE 2 OUT terminals	24
Operating components not reached by the remote controller signals (IR IN/OUT)	25
If the remote controller signal does not reach the DTR-8.2 remote sensor	25
If the remote controller signal does not reach other components	25
Connecting antennas	26
Assembling the AM loop antenna	26
Connecting the AM antenna cable	26
Connecting the included antennas	26
Connecting an FM outdoor antenna	27
Connecting an AM outdoor antenna	27
Directional linkage	27
Connecting the power	28

Setup and operation

Setup menus	29
Navigating through the Setup menu	30
Hardware Setup	31
0. Hardware Setup menu	31
0-1. Speaker Impedance sub-menu	31
0-2. IR IN Setup sub-menu	31
Speaker Setup	32
1. Speaker Setup menu	32
1-1. Speaker Config sub-menu	32
1-2. Speaker Distance sub-menu	33
1-3. Level Calibration sub-menu	34
1-4. Bass Peak Level (Bass Peak Level Manager*) sub-menu	35
Input Setup	36
2. Input Setup menu	36
2-1. Digital Setup sub-menu	36
2-2. Multichannel Setup sub-menu	37
2-3. Video Setup sub-menu	38
2-4. Character Input sub-menu	39
2-5. Intelli Volume sub-menu	39
2-6. Listening Mode Preset sub-menu	40
2-7. 12V Trigger Setup sub-menu	42
Audio Adjust	43
3. Audio Adjust Setup menu	43
Preference	47
4. Preference menu	47
4-1. Volume Setup sub-menu	47
4-2. Headphones Level Setup sub-menu	48
4-3. OSD Setup sub-menu	48
4-4. OSD Position sub-menu	48
Listening to Radio Broadcasts	49
Tuning into a radio station	49
Listening to a stereo radio station (FM mode)	49
Presetting a radio station	50
Selecting a preset radio station	50
Erasing a preset radio station	50
Enjoying music or videos with the DTR-8.2	51
Basic operation	51
Temporarily turning off the sound	51
Adjusting the bass and treble	51
Listening with headphones	51
Changing the listening mode	52
Switching the display	53
Adjusting the brightness of the front display	53
Using the sleep time (remote controller only)	53
Temporarily changing the speaker output levels	53
Changing the audio mode	54
Enjoying the multichannel output	54
Entering names for input sources and tuner stations	55

Contents

Enjoying music in the remote zone	56
Playing music using the buttons on the DTR-8.2	56
Selecting an input source using the remote controller ..	56
Adjusting the volume for the remote zone	56
Recording a source	57
To record the input source signal you are currently	
watching or listening to	57
To record an input source signal different from that	
you are currently watching or listening to	57
Recording the video from one source and	
the audio from another	58

Remote controller

Quick Start	59
Insert batteries	59
Touch the screen to start	59
Operate your components	59
Quick reference	60
Modes	60
Introduction	61
1. Intelligent Remote Controller	61
Left and Right buttons	62
Touchscreen buttons	62
Which Buttons Can Be Programmed?	62
2. Charging the Remote Controller	63
AA batteries	63
Optional recharging dock	63
Getting Started	65
1. Activate the remote controller	65
Turning on the display	65
Using the backlight	65
Use mode	65
2. Define the Brand of Your Device	66
Defining brands by selecting	66
Defining brands by searching	68
3. Select a Device	69
Via the Home menu	69
Via the Device menu	69
4. Operate a Device	70
Using touchscreen buttons	70
Using the Left and Right button	70
Using the direct-access buttons	70
5. Adjust the Settings	70

Getting the Maximum out of it	72
1. Introduction	72
Working with Modes	72
2. Programming Buttons	72
Programming control panel buttons	73
Programming device items	73
Programming direct-access and Left/Right Buttons	73
3. Labeling Buttons and Menu Items	74
Labeling a button	74
Labeling a menu item	74
4. Adding and Moving Devices	75
Adding devices	75
Moving menu items	75
5. Delete and restore	76
Delete	76
Restore	76
6. Recording Macros and Setting Timers	77
Recording macros	77
Editing macros	77
Setting timers	78
Editing timers	78
7. Using the remote controller	
with Radio Frequency	79
Changing the remote controller's RF IR Settings	79
Choosing Another Channel	80
8. ChadEdit	81
System requirements	81
Troubleshooting	82
General Problems	82
Programming Problems	82
Recharging Problems	82
FAQ	83
Overview of Symbols	84
Specifications	85

Appendix

Troubleshooting guide	86
POWER	86
SPEAKERS	86
FM/AM TUNER	86
VIDEO and AUDIO	87
OTHER	87
If one of the messages shown below appears	87
Specifications	back cover

Features

Amplifier Features

- 110 Watts minimum of continuous RMS power to each of the seven channels into 8 Ω from 20 Hz to 20 kHz with no more than 0.08 %THD (FTC rated)
- 7 Channel Amplifier
- Wide Range Amplifier Technology (WRAT)
- Linear Optimum Gain Volume Circuitry
- 192 kHz/24 Bit D/A Converters (except for Surround Back L/R)
- Ready for HDTV, Progressive-Scan DVD and DVD-Audio
- Zone-2 Capability

Audio/Video Features

- THX® Surround EX®
- THX Select Certified
- Dolby® Digital, Dolby Pro Logic II
- DTS, DTS-ES Discrete 6.1, DTS-ES Matrix 6.1 and DTS Neo:6
- Theater-Dimensional™ Virtual Surround Mode
- Non-Scaling Configuration
- Onscreen displays (Basic menu/Advanced menu)
- 2 Wideband Component-Video Inputs/1 Output
- Composite to S-Video Conversion
- 6 S-Video Inputs/3 Outputs
- A-BUS Ready
- 12V Trigger

- 7 Assignable Digital Inputs (4 optical/3 Coaxial), 2 outputs, and 1 Digital Input (optical)
- Pre Out Terminals for Front L/R, Center, Surround L/R, Surround back L/R or Zone 2 L/R and Subwoofer

FM/AM Tuner Features

- 40 FM/AM random presets
- FM auto tuning

Other Performance Features

- IntelliVolume
- Character Input
- Unique and fully customizable universal touchscreen remote controller

* Manufactured under license from Dolby Laboratories.

“Dolby,” “Pro Logic,” “Surround EX” and the double-D symbol are trademarks of Dolby Laboratories.

- “Theater-Dimensional” is a trademark of Onkyo Corporation.
- Lucasfilm and THX are trademarks of Lucasfilm Ltd. All rights reserved. Used under authorization.
- Re-Equalization and the “Re-EQ” logo are trademarks of Lucasfilm Ltd. Manufactured under license of Lucasfilm Ltd.
- “DTS,” “DTS-ES Extended Surround” and “Neo:6” are trademarks of Digital Theater Systems, Inc.
- A-BUS and A-BUS Ready are registered trademarks of LeisureTech Electronics Pty Ltd Australia.
- Xantech is a registered trademark of Xantech Corporation.
- Niles is a registered trademark of Niles Audio Corporation.

THX Select

Before any home theatre component can be THX Select certified, it must pass a rigorous series of quality and performance tests. Only then can a product feature the THX Select logo, which is your guarantee that the Home Theatre products you purchase will give you superb performance for many years to come. THX Select requirements define hundreds of parameters, including power amplifier performance, and pre-amplifier performance and operation for both digital and analog domains. THX Select receivers also feature proprietary THX technologies (e.g., THX Mode, see page 42) which accurately translate film soundtracks for home theater playback.

Supplied accessories

Check that the following accessories are supplied with the DTR-8.2.

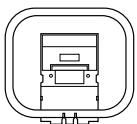

AM loop antenna × 1

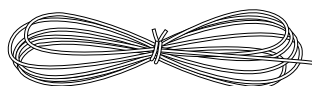

FM indoor antenna × 1

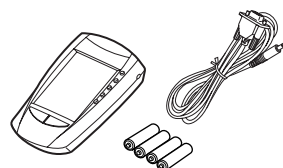

Remote controller × 1
Batteries (AA, R6 or UM-3) × 4
RS232 cable for PC connection × 1

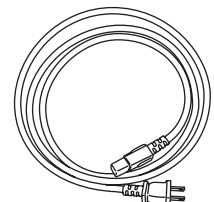

Power cord × 1

Before using this unit

Insert batteries

1. Slide the battery cover off the back of the remote controller.
2. Insert 4 AA batteries (included in package) as indicated on the bottom of the battery compartment.
3. Slide the battery cover back on.

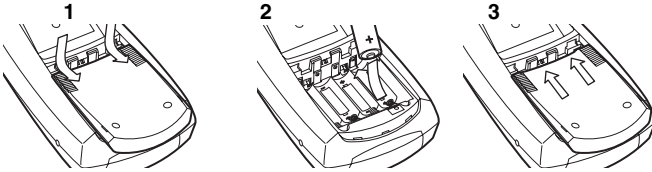

Notes:

- Do not mix new batteries with old batteries or different kinds of batteries.
- To avoid corrosion, remove the batteries if the remote controller is not to be used for a long time.
- Remove dead batteries immediately to avoid damage from corrosion. If the remote controller does not operate smoothly, replace both the batteries at the same time.

Using the remote controller

Point the remote controller toward the remote control sensor. The STANDBY indicator lights up when the unit receives a signal from the remote controller.

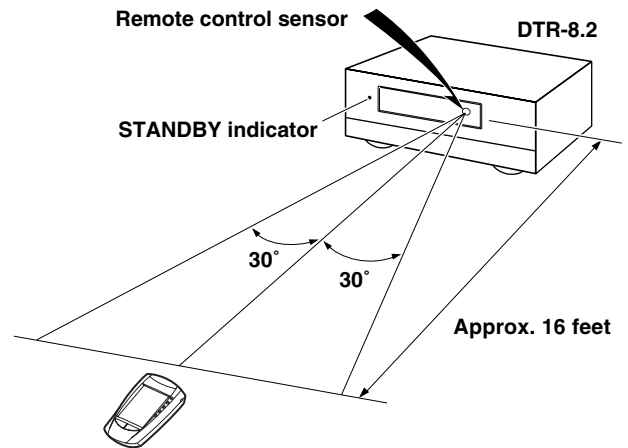

Notes:

- Place the unit away from strong light such as direct sunlight or inverted fluorescent light which can prevent proper operation of the remote controller.
- Using another remote controller of the same type in the same room or using the unit near equipment which uses infrared rays may cause operational interference.
- Do not put objects on the remote controller. Its buttons may be pressed by mistake and drain the batteries.
- Make sure the audio rack doors do not have colored glass. Placing the unit behind such doors may prevent proper remote controller operation.
- If there is any obstacle between the remote controller and the remote control sensor, the remote controller will not operate.

Front panel facilities

Here is an explanation of the controls and displays on the front panel of the DTR-8.2.

Front panel

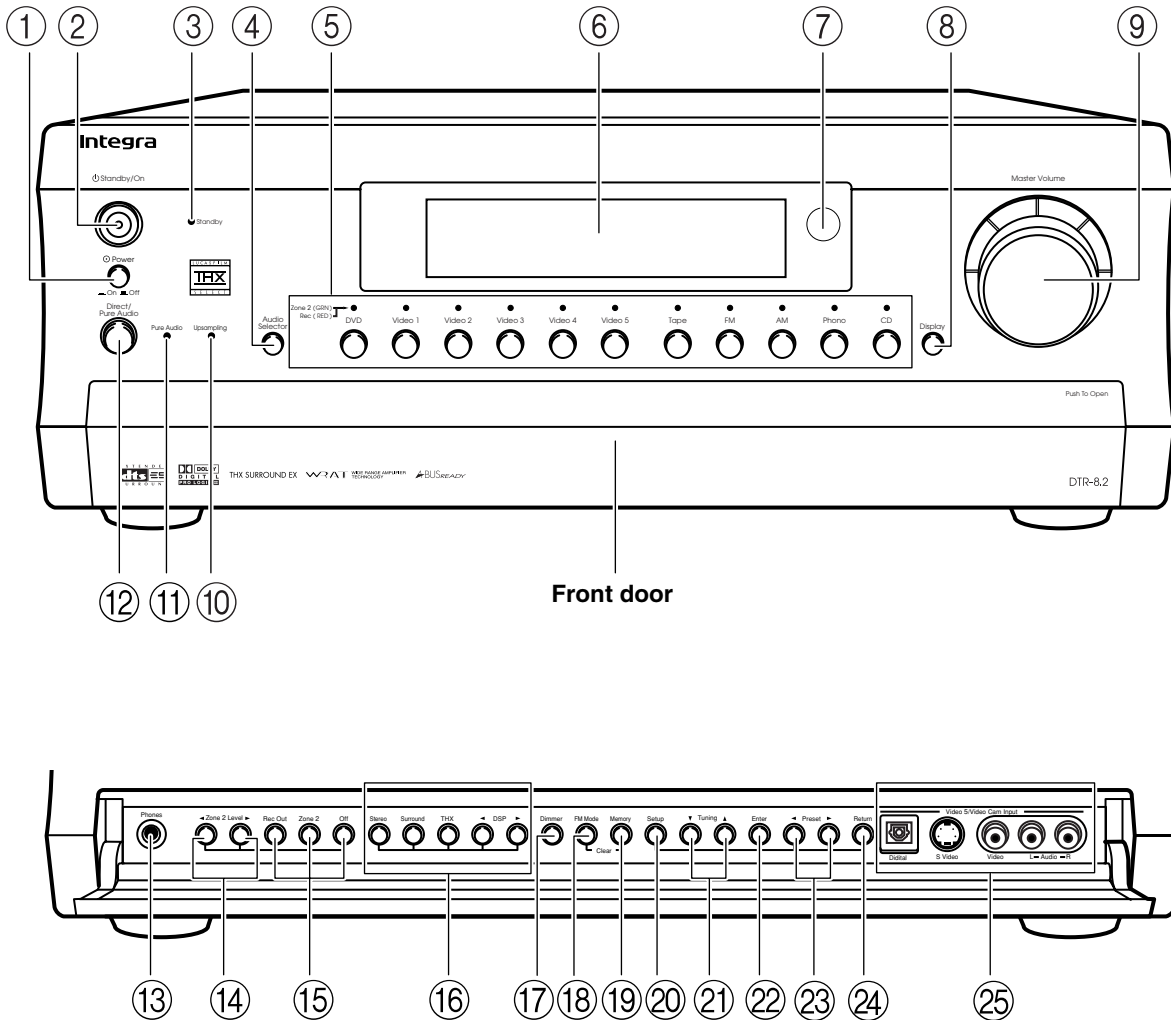

Front panel display

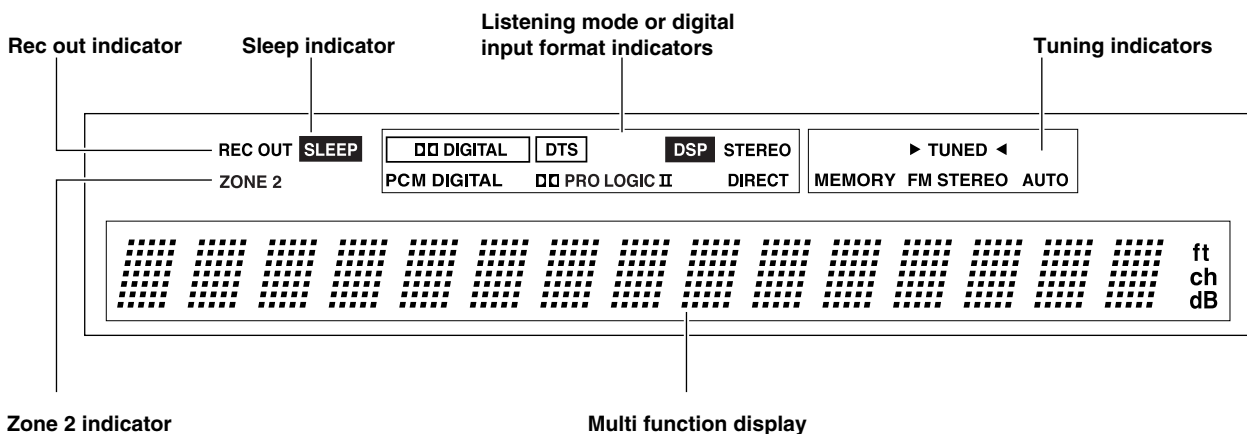

Front panel facilities

For operational instructions, see page indicated in brackets [].

① Power switch [28]

Turns on and off the main power supply for the DTR-8.2.

② Standby/On button [28]

When this button is pressed with the main power switch turned on, the DTR-8.2 turns on and the display lights up. Press again to return the DTR-8.2 to the standby state.

③ Standby indicator [7, 28]

Lights when the DTR-8.2 is in the standby state and flashes when a signal is received from the remote controller.

④ Audio Selector button [54]

This button is used to select the type of audio input signal. Each time pressed, the setting cycles from “Auto” → “Multich” → “Analog” and back.

⑤ Input source buttons (DVD, Video 1–5, Tape, FM, AM, Phono, and CD) [51, 56]

These buttons are used to select the input source for the main zone. To select the input source for the remote zone (Zone 2) or recording out (Rec Out), first press the Zone 2 or Rec Out button, and then the desired input source button. The input channel with its indicator lit red is output to Rec Out and the one with its indicator lit green is output to Zone 2.

⑥ Front display

⑦ Remote control sensor [7]

⑧ Display button [53]

The Display button is used to display information about the current input source signal. Each time you press the Display button, the screen changes to show you different information concerning the input signal.

⑨ Master Volume dial [51]

The Master Volume dial is used to control the volume for the main zone. The volume for the remote zone (Zone 2) is independent.

⑩ Upsampling indicator [43]

Lights during upsampling. This function is available when the input source is Analog/PCM and the listening mode is set to the stereo or surround mode.

⑪ Pure Audio indicator [54]

Lights during pure audio playback.

⑫ Direct/Pure Audio button [54]

Press to switch between the direct and pure audio modes.

Direct: The direct mode outputs the sound without sound adjustment or filtration. In the direct mode, even if the Subwoofer setting of the Speaker Config sub-menu is set to “Yes,” no sound is output from the subwoofer and the left and right channels are output, as is, to the left and right speakers. Even for multichannel input signals, the sounds are not passed through the sound adjustment circuits.

Pure Audio: Same as the direct mode except that the pure audio mode also turns off the display window, turns off the power supply to the video circuitry, and minimizes the sources of noise. The result is high-fidelity music playback true to the original source.

⑬ Phones jack [51]

This is a standard stereo jack for connecting stereo headphones.

⑭ Zone 2 Level ◀▶ buttons [56]

Press to enter the mode for adjusting the volume in the remote zone (Zone 2).

⑮ Rec Out/Zone 2/Off buttons [56-58]

These buttons allow you to use the DTR-8.2 to output to a remote zone (Zone 2) or to another component for recording purposes (Rec Out). Press the Rec Out button to output the audio and video signals to a recording component for recording purposes. Press the Zone 2 button to enjoy the output from the DTR-8.2 in a different room, which is referred to as a remote zone (Zone 2).

When either button is pressed, the currently selected input source for recording or outputting to the remote zone is displayed in the front panel display. If “SOURCE” is displayed, then the same input source as that selected for the main zone will be output.

To select an input source, press the desired button (Rec Out or Zone 2) and then press one of the input source buttons within 5 seconds. That source will be output for recording or viewing in the remote zone.

To set the Rec Out or Zone 2 output to the source channel, press that button twice in succession. To turn off the Rec Out or Zone 2 output, press that button and then press the Off button within 5 seconds.

Note:

The Rec Out and Zone 2 buttons use the same circuit and therefore cannot be used at the same time. When Rec Out is selected, nothing is output to Zone 2, and vice versa. When Zone 2 is selected, Rec Out is automatically fixed to SOURCE.

⑯ Listening mode buttons [52]

Press these buttons to select a listening mode for the current input source.

Stereo: Selects for normal stereo output.

Surround: Selects for the Dolby Pro Logic, Neo:6, Dolby Digital, or DTS listening modes.

THX: Selects for the THX listening mode.

DSP ◀▶: Switches to the listening mode before or after the current one.

⑰ Dimmer button [53]

Press to set the brightness of the front display. There are 3 settings available: normal, dark, and very dark.

- The dimmer control for the front display can be performed at the remote controller.

⑱ FM Mode button [49]

If you are listening to an FM radio station in stereo and the sound cuts out or there is a great deal of noise, switch from Stereo to MONO. Each time this button is pressed, the AUTO indication turns on and off, and the stereo mode changes from AUTO to MONO and vice versa.

⑲ Memory button [50]

This button is used to assign the radio station that is currently tuned in to a preset channel or delete a previously preset station.

⑳ Setup button [30]

Press to bring up the Setup menu. The OSD menu will appear on the TV monitor as well as the front display on the DTR-8.2.

Front panel facilities

②1 Tuning ▲/▼ buttons [49]

Use these buttons to change the tuner frequency. The tuner frequency is displayed in the front display and it can be changed in 50 kHz increments for FM and 10 kHz increments for AM.

When FM is selected, you can hold down one of the tuning buttons and then release it to activate the auto-search feature. It will search for a station in the direction of the button you pressed and stop when it tunes into one. When navigating through the menu settings, these buttons move the cursor up or down (or change the highlighted item).

②2 Enter button [30]

Press to display the screen for the selected item in the OSD Menu.

②3 Preset ◀▶ buttons [50]

When AM or FM is selected as the input source, press one of these buttons to jump to a radio station that you preset using the Memory button. When navigating through the menu settings, these buttons select the value or item that you selected with the Tuning ▲/▼ buttons.

②4 Return button [30]

Press to exit the Main menu level or go back one level up.

②5 Video 5/Video Cam Input terminals [21]

For connecting a video camera or game device.

Remote controller

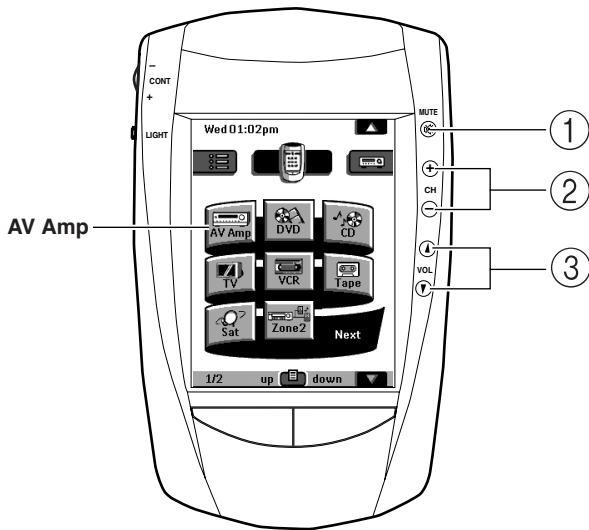

For details on how to use the remote controller, refer to “Using the remote controller” (page 59).

Select AV Amp in the Home menu to display the operation buttons.

① MUTE button

Activates the mute function. [51]

② CH +/- button

When AV Amp is selected, for selecting a tuner preset channel. [50]

③ VOL ▲/▼ buttons

When AV Amp is selected, for adjusting the volume. When Zone 2 is selected, for adjusting the volume in the Zone 2.

First operation menu (page 1/3)

④ ON button

Turns on the DTR-8.2.

⑤ OFF button

Places the DTR-8.2 in the standby state.

⑥ LISTEN button

For displaying listening mode buttons.

⑦ SETUP button

For displaying setup operation buttons.

⑧ Input Selector buttons

Select an input source.

CD: CD, DVD: DVD, Tuner: FM/AM, Phono: PHONO, Tape1: TAPE, Tape2: Not used with the DTR-8.2, Video1: VIDEO 1, Video2: VIDEO 2, Video3: VIDEO 3, Video4: VIDEO 4, Video5: VIDEO 5

⑨ Audio Sel button

For selecting the audio input signal. The setting changes from “Auto” to “Multich” to “Analog” and back each time this button is pressed. [54]

(Page 1/3)

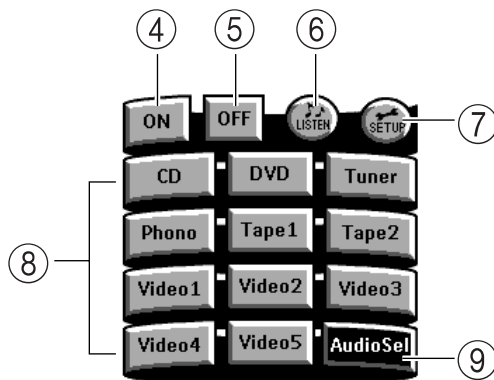

Second operation menu (page 2/3)

⑩ Listening mode buttons

Direct: Changes the listening mode directly to the Direct listening mode. If pressed, the listening mode for the selected input source set in the Listening Mode Preset is also changed to the Direct listening mode. When the listening mode is set to Direct, you can switch between Direct and Pure Audio.

Stereo: Changes the listening mode directly to the Stereo listening mode. If pressed, the listening mode for the selected input source set in the Listening Mode Preset sub-menu is also changed to the Stereo listening mode.

Surr: Changes the listening mode to the surround mode for the current input signal (e.g., Dolby Pro Logic II, Dolby Digital, or DTS). If pressed, the listening mode for the selected input source set in the Listening Mode Preset is also changed to the Surround listening mode.

When the Surround listening mode is selected

- **When playing back DTS sources**
Switches the DTS-ES setting from Auto → On → Off.
- **When playing back Analog/PCM sources**
Switches from Pro Logic II Movie → Pro Logic II Music → DTS Neo6:Cinema → DTS Neo6:Music.
- **When playing back D.F. 2-channel sources**
Switches from Pro Logic II Movie → Pro Logic II Music.

(Page 2/3)

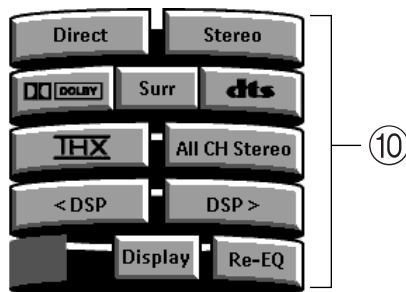

Remote controller



(Page 3/3)

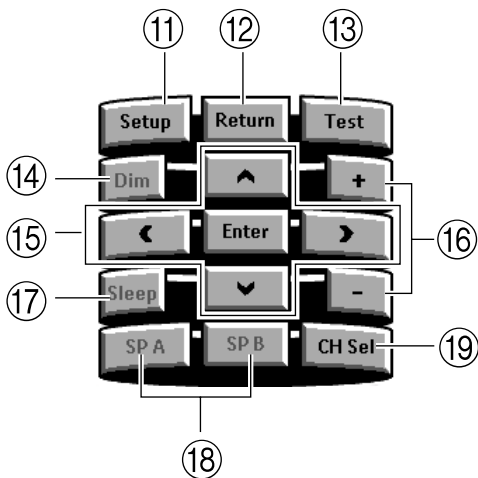

DOLBY: When the input source is a digital source, this button works as the same for the Surr button. When the input source is Analog/PCM, this button changes the listening mode between Dolby Pro Logic II Movie and Dolby Pro Logic II Music.

dts: When the input source is a digital source, this button works as the same for the Surr button. When the input source is Analog/PCM, this button changes the listening mode between DTS Neo:6 Music and DTS Neo:6 Cinema. Neo6:Cinema → DTS Neo6:Music.

THX: Changes the listening mode to the THX listening mode.

When the THX listening mode is selected

• When playing back Dolby Digital sources

Switches the THX Surround EX mode (Auto → On → Off) if the source is a Dolby Digital-compatible source.

• When playing back Analog/PCM sources

Switches the decoding mode (Pro Logic II Movie → DTS Neo6:Cinema) for THX processing.

• When playing back DTS sources

Allows you to enjoy the DTS THX Cinema, DTS-ES Discrete 6.1 THX Cinema, and DTS-ES Matrix 6.1 THX Cinema surround systems. The DTS-ES mode changes from Auto → On → Off.

All CH Stereo: Changes the listening mode to All Channel Stereo listening mode.

DTS ◀▶: Changes the listening mode as shown below.

Mono → Direct/Pure Audio → Stereo → Theater-Dimensional → Surround → THX → Mono Movie → Enhanced 7 → Orchestra → Unplugged → Studio-Mix → TV Logic → All Ch Stereo → Mono. If pressed, the listening mode for the selected input source set in the Listening Mode Preset is also changed.

Display: For changing the display in the front display.

Re-EQ: Depending on the listening mode, you can turn the cinema re-equalization function on or off. [43, 46]

Third operation menu (page 3/3)

⑪ Setup button

For displaying and quitting the setup menu. [30]

⑫ Return button

For entering the selected setting and returning to the previous menu. [30]

⑬ Test button

Outputs a test tone for setting speaker levels.

Use this button in conjunction with the +/- and CH Sel buttons to calibrate the speakers levels without entering the Setup menu. When TEST button is pressed, the test noise (pink noise) is output. Use the +/- buttons to increase or decrease the sound level. Use the CH Sel button to change from speaker to speaker. For a more detailed explanation of how to calibrate the speaker levels, see page 34.

⑭ Dim button

Adjusts the display brightness.

There are three settings available: normal, dark and very dark. [53]

⑮ ▲/▼/◀/▶, Enter buttons

When selecting items in the Setup menu, press the upper and lower portions to select item, press the right and left portions to select parameter values or modes, and press Enter to select item. [30]

⑯ +/- buttons

Select the speaker whose volume is to be adjusted using the CH Sel button and adjust the volume using the +/- buttons. [53]

⑰ Sleep button

Sets the sleep function.

The Sleep button enables you to set the DTR-8.2 to turn off automatically after a specified time period. [53]

⑱ SP A/B buttons

These buttons are not used with the DTR-8.2.

⑲ CH Sel button

For selecting the speaker for level adjustment. Used together with the +/- buttons. [53]

Remote controller

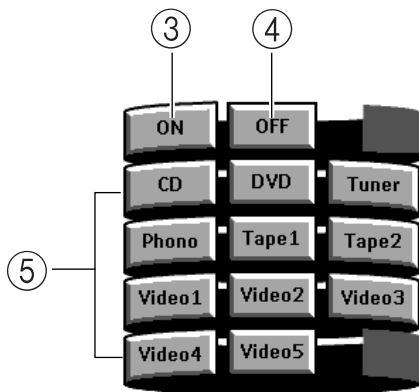
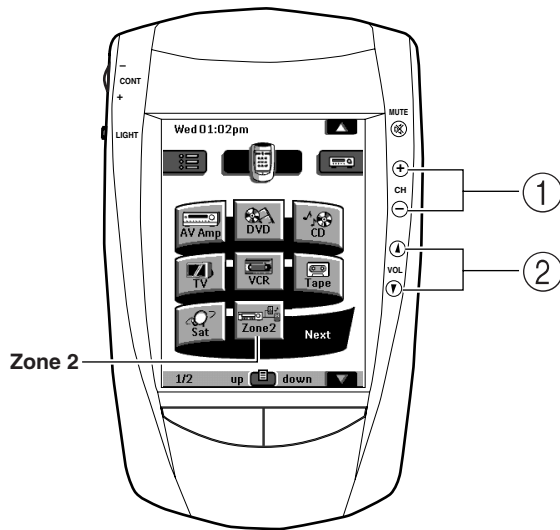

Select Zone 2 in the Home menu to display the Zone 2 operation buttons. [56]

① **CH +/- button**

For selecting a tuner preset channel in the remote zone (Zone 2).

② **VOL ▲/▼ buttons**

For adjusting the volume in the remote zone (Zone 2).

③ **ON button**

For disabling the function of the remote zone (Zone 2).

④ **OFF button**

For activating the function of the remote zone (Zone 2).

⑤ **Input Selector buttons**

Selects an input source.

CD: CD, DVD: DVD, Tuner: FM/AM, Phono: PHONO, Tape1: TAPE, Tape2: Not used with the DTR-8.2, Video1: VIDEO 1, Video2: VIDEO 2, Video3: VIDEO 3, Video4: VIDEO 4, Video5: VIDEO 5

Rear panel facilities

Here is an explanation of the terminals found on the rear of the DTR-8.2 and how they are used. Before connecting your audio and video components, be sure to read this section carefully and then proceed to the explanations on how to connect each individual component (see page 18).

- Be sure to always refer to the instructions that came with the component that you are connecting.
- Do not plug in the power cord until all connections have been made.
- For input jacks, red connectors (marked R) are used for the right channel, white connectors (marked L) are used for the left channel, and yellow connectors (marked V) are used for video connection.

- Insert all plugs and connectors securely. Improper connections can result in noise, poor performance, or damage to the equipment.

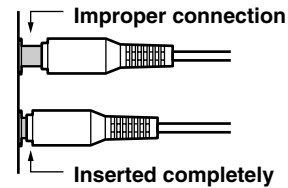

- Do not bind audio/video connection cables with power cords and speaker cables. Doing so may adversely affect the picture and sound quality.

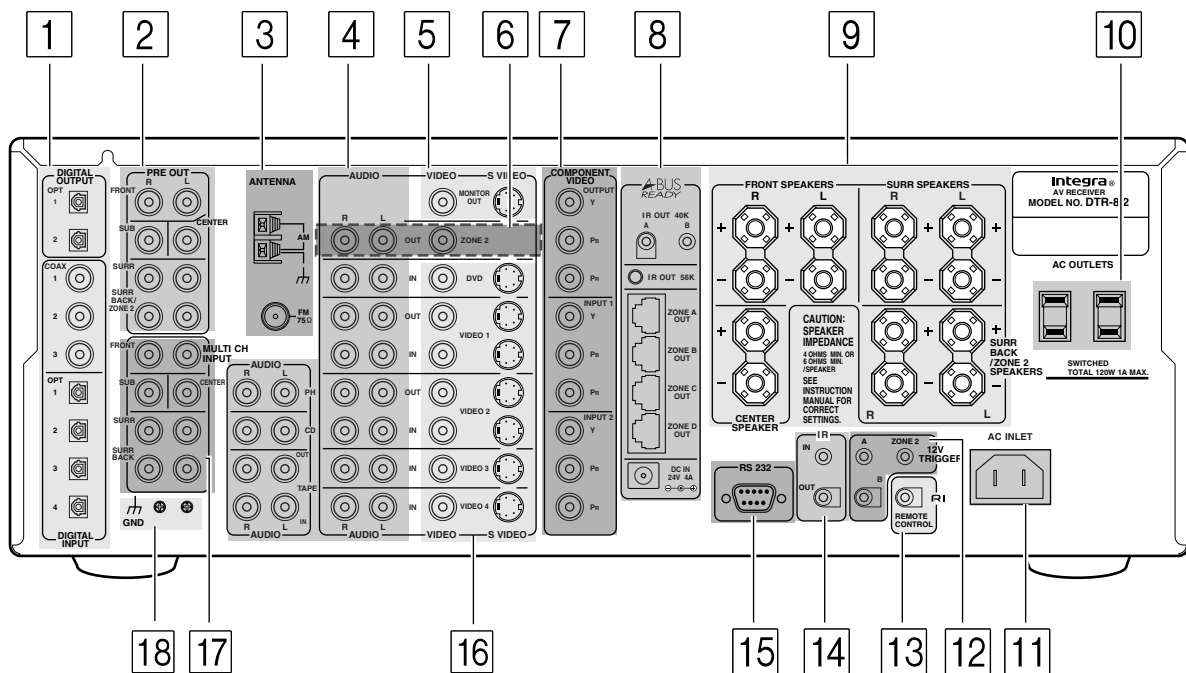

1 DIGITAL INPUT/OUTPUT (coaxial and optical)

These are the digital audio inputs and outputs on the rear panel. There are three digital inputs with coaxial jacks and four with optical jacks. The inputs accept digital audio signals from a compact disc, LD, DVD, or other digital source component. For digital output, there is 1 optical output. The digital outputs can be connected to MD recorders, CD recorders, DAT decks, or other similar components.

- Since an analog connection must be made when using REC OUT or ZONE 2, make sure that the connection to the input source is not digital only, but analog as well.
- When using one of the optical input or output jacks, remove the protective cap and keep it safely. When the jack is not used, replace the protective cap.
- When using an optical input or output jack, always use an optical fiber cable.

COAXIAL Coaxial cable

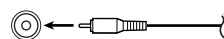

OPTICAL Optical fiber cable

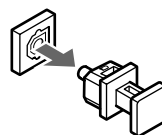
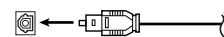

Optical digital input terminal

An optical digital input terminal is equipped with a protection cap. When connecting, remove this cap. When not using, put the cap back on the terminal.

Rear panel facilities

2 PRE OUT

These jacks are for connecting auxiliary power amplifier. Using auxiliary power amplifiers allows you to listen at louder volumes than with the DTR-8.2 alone. If power amplifiers are used, connect each speaker to the corresponding power amplifier.

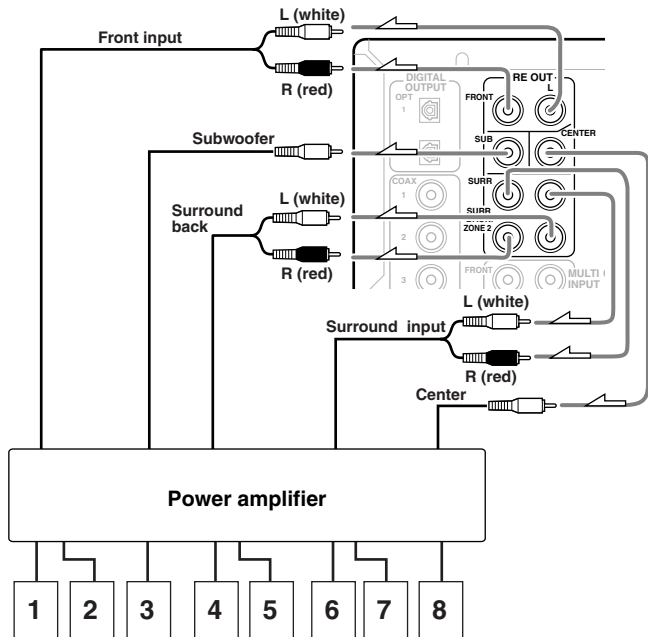

- | | |
|-------------------------------|--------------------------------|
| 1. Front left speaker | 5. Surround back right speaker |
| 2. Front right speaker | 6. Surround left speaker |
| 3. Subwoofer | 7. Surround right speaker |
| 4. Surround back left speaker | 8. Center speaker |

3 ANTENNA

These jacks are for connecting the FM indoor antenna and AM loop antenna that are supplied with the DTR-8.2.

4 AUDIO IN/OUT

These are the analog audio inputs and outputs. There are eight audio inputs and 3 audio outputs. The audio inputs and outputs require RCA-type connectors.

- When connecting a VCR or other video component, make sure you connect the audio and video leads together (i.e., both to VIDEO 3).
- The PHONO (PH) input jacks on the DTR-8.2 is designed for use with turntables that use moving magnet cartridges.

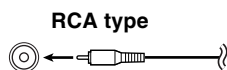

5 MONITOR OUT

The monitor output includes both composite video and S video configurations. This output is for connecting television monitors or projectors.

6 ZONE 2 AUDIO/VIDEO OUT

Connect the device that will be used in the remote zone (Zone 2). For more information regarding how to make the connections, refer to "Connecting the remote zone (Zone 2) speakers" on page 24.

7 COMPONENT VIDEO INPUT/OUTPUT

If your DVD player or other device has component video connectors, be sure to connect them to these component video connectors on the DTR-8.2. The DTR-8.2 has two component video input connectors to obtain the color information (Y, PB, PR) directly from the recorded DVD signal or other video component and one component video output connector to output it directly into the matrix decoder of the display device. By sending the pure DVD component video signal directly, the DVD signal forgoes the extra processing that normally would degrade the image. The result is vastly increased image quality, with incredibly lifelike colors and crisp detail.

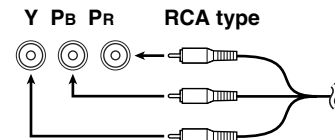

8 A-BUS

Congratulations for purchasing a most efficient, modern-day remote controllable whole house audio system. A-BUS is a simple, efficient, elegant audio distribution system. The wiring installation time is significantly reduced as only a single CAT-5 wire is run to each location. A-BUS is easy to use, reliable, affordable, and most of all, far better sounding than conventional autoformer based volume controls.

ZONE A/B/C/D: Use a CAT-5 (eight conductor twisted) cable to connect directly from the receiver's A-BUS RJ45 Hub to an A-BUS keypad. A-BUS outputs enable connection up to four A-BUS keypads.

Warning:

DO NOT connect A-BUS outputs to any computer or network connections (i.e. ethernet). It will cause damage to the computer or network components as 24-volt power runs on this same cable to power the amplifier stages of the amplifier module.

IR control: Another feature of the A-BUS system is the ability to control source equipment in another room where the A-BUS module is installed. If you wish to control another source from the receiver at the A-BUS keypad by remote control, connect A-BUS or another brands' IR emitter on the receiver's 40 k terminal. Then place the emitter on the remote receiver on the front panel.

Typically, the emitter will work when you connect with a 40 K connector. If it does not work, try a 56 K connector.

DC INPUT: Connect A-BUS power supply. Do not use any other AC Adapter on this connector as it may cause severe damage to the receiver.

9 SPEAKERS

Seven terminals are provided for the front left, front right, front center, surround left, surround right, surround back left, and surround back right speakers. Speaker outputs are compatible with banana plug connectors.

Rear panel facilities

10 AC OUTLETS

The DTR-8.2 is supplied with AC mains outlets for connecting the power cords from other devices so that their power is supplied through the DTR-8.2. By doing this, you can use the Standby/On button on the DTR-8.2 to turn on and off the connected devices as well.

Caution:

Make sure that the total capacity of the other components connected to this unit does not exceed the capacity that is printed on the rear panel (e.g., 120 watts).

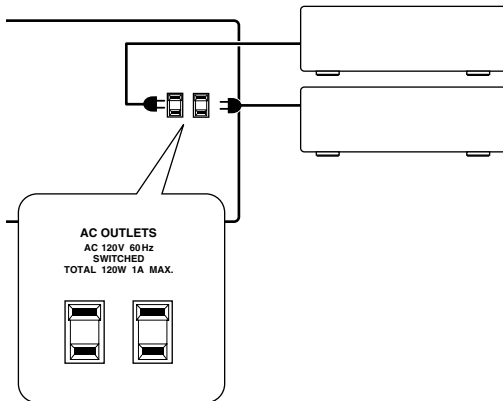

11 AC INLET

Plug the supplied power cord into this AC INLET and then into the power outlet on the wall.

- Do not use a power cord other than the one supplied with the DTR-8.2. The power cord supplied is designed for use with the DTR-8.2 and should not be used with any other device.
- Never have the power cord disconnected from the DTR-8.2 while the other end is plugged into the wall outlet. Doing so may cause an electric shock. Always connect by plugging into the wall outlet last and disconnect by unplugging from the wall outlet first.

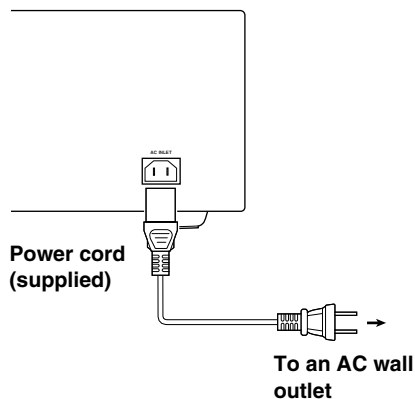

12 12V TRIGGER A/B/ZONE 2 terminal

These terminals are provided so that you can use the operation of the DTR-8.2 control the operation of another externally connected device. Connect the component to this 1/8-inch mini-jack terminal and when the set input source is selected, the device will turn on. Set the 12V TRIGGER terminal using the Setup menu: Input setup → 12V trigger (see page 42).

When the DTR-8.2 is in the ZONE 2 mode, this terminal outputs at 12 V/100 mA.

13 RI (RI)

The RI terminal on the DTR-8.2 is for connecting other Integra/Onkyo components equipped with the same RI terminal. When a component is RI-connected, you can point the remote controller supplied with the DTR-8.2 at the sensor on the DTR-8.2 and operate that component without having to switch remote controllers. In addition, by connecting components to the RI terminal, you can also perform the system operations given below.

Power on/ready function

When the DTR-8.2 is in the standby state, if an RI-connected component is turned on, then the DTR-8.2 also turns on and the input source selected at the DTR-8.2 automatically switches to that component.

If the power cord for an RI-connected component is connected to the AC OUTLET on the DTR-8.2, or if the DTR-8.2 is turned on, this function will not work.

Direct change function

When the play button is pressed at an RI-connected component, the input source selected at the DTR-8.2 automatically changes to that component.

Power off function

When the DTR-8.2 is placed in the standby state, all RI-connected components are also automatically put into the standby state.

CAUTION

If an MD recorder is connected to the TAPE jack on the DTR-8.2, switch the Input Selector from TAPE to MD (see page 28).

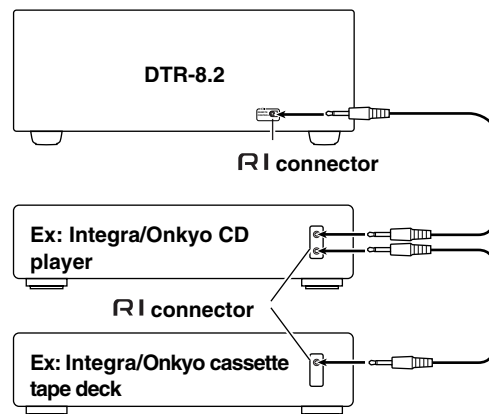

To connect components using the RI terminal, simply connect a remote control cable from this RI terminal to the RI terminal of the other component. An RI remote control cable with a 1/8-inch (3.5-mm) miniature two-conductor plug comes with every cassette tape deck, compact disc player, MD recorder, and DVD player that has an RI terminal.

- When performing operations with RI-connected components using the RI system, do not use the remote zone (Zone 2).
- For remote control operation, the audio connection cables must also be connected.
- If a component has two RI terminals, you can use either one to connect to the DTR-8.2. The other one can be used to daisy chain with another component.

Rear panel facilities

14 IR IN/OUT

If the DTR-8.2 is located inside a rack or cabinet that will not allow infrared beams to reach the IR sensor, you will need to connect a remote sensor to IR IN input to be able to use the remote controller. Then install the remote sensor in an unblocked location where you can easily point the remote controller.

Using a mini-jack connector, connect the IR emitter to the IR OUT terminal on the DTR-8.2 and then place the IR emitter on the remote sensor of the component or facing it.

15 RS 232

The RS 232 port is to be used in conjunction with an external controller to control the operation of the DTR-8.2 by using an external device.

16 VIDEO IN/OUT

These are the video inputs and outputs. On the rear panel, there are five video inputs and two video outputs and each one includes both composite video and S video configurations. Connect VCRs, LD players, DVD players, and other video components to the video inputs.

The two video output channels can be used to be connected to video tape recorders for making recordings.

- When connecting a VCR or other video component, make sure you connect the audio and video leads together (i.e., both to VIDEO 3).
- The Video 5 inputs are located on the front panel.

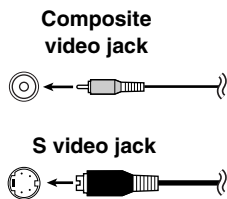

17 MULTI CHANNEL INPUT

By connecting a DVD player, MPEG decoder, or other component that has a multi channel port, you can playback the audio with 5.1 channel or 7.1 channel output. So, be sure to prepare a cable that can properly connect the DTR-8.2 to the peripheral device.

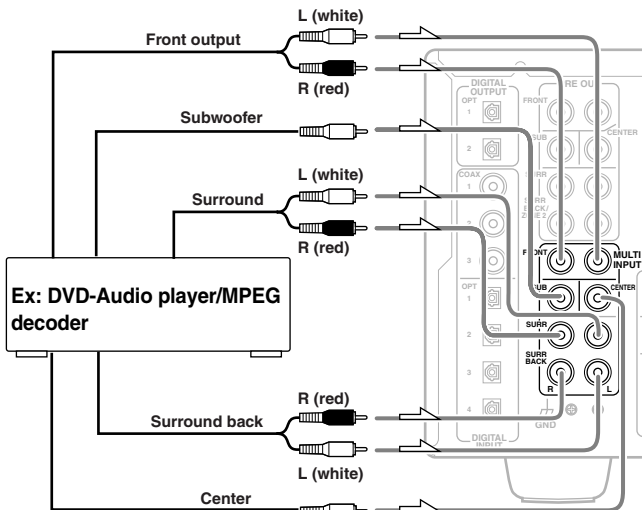

18 GND

Use this GND terminal for connecting the ground (or earth) wire if a turntable is connected. Refer to "Connecting a turntable" on page 18.

Connections

Here is an explanation of how to connect the main components to the DTR-8.2 in the standard manner. There are many ways that any one component can be connected, and it is up to you to decide which method best fits your situation. The directions given here are only one option and should only be thought of as such. It is best to fully understand the nature of each connector and terminal as well as each of your components and their features to ascertain which method of connection is best.

 : Signal flow

Audio connection cable

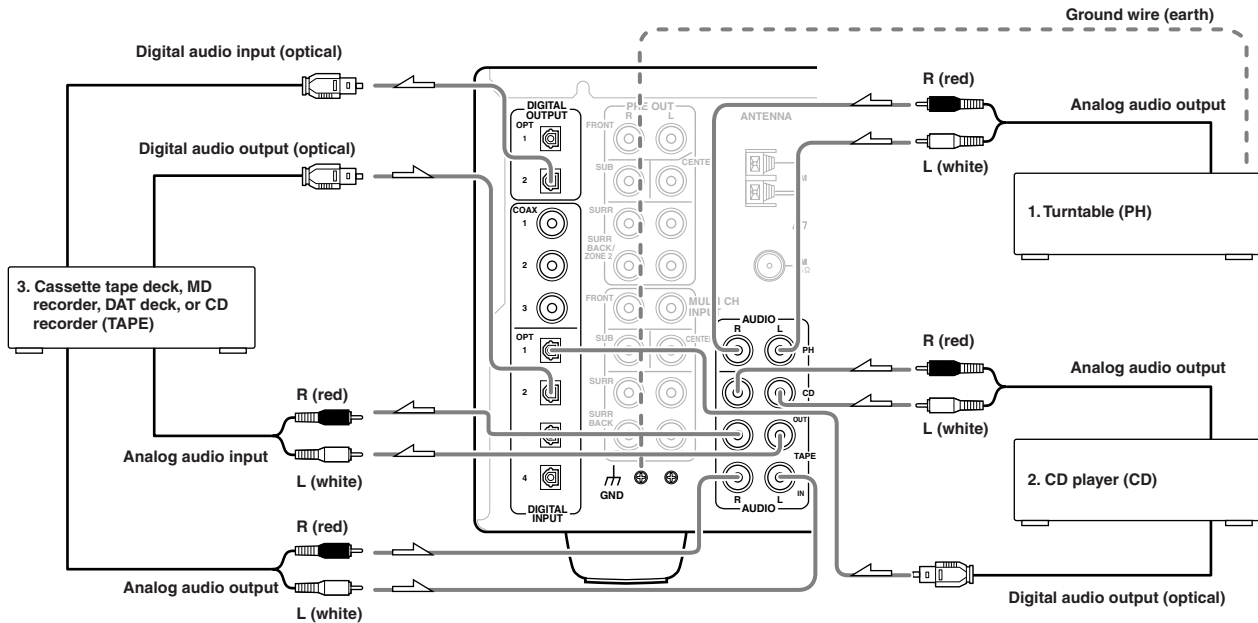
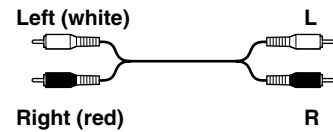

Connecting your audio components

Below is an example of how you can connect your audio components to the DTR-8.2. Refer to the diagram above for the following connection examples.

1. Connecting a turntable (PH)

Using an RCA-type audio connection cable, connect the output terminal on the turntable to the PH input jacks on the DTR-8.2. Make sure that you properly connect the left channel to the L jack and the right channel to the R jack.

Note:

The DTR-8.2 is designed for use with moving magnet cartridges. For proper operation, connect a ground (or earth) wire to the GND terminal. For some turntables, however, connecting the ground wire may cause increased noise, and in such a case, a ground wire is not necessary and should not be connected.

2. Connecting a compact disc player (CD)

Using an RCA-type audio connection cable, connect the output terminal on the compact disc player to the CD input jacks on the DTR-8.2. Make sure that you properly connect the left channel to the L jack and the right channel to the R jack.

If the compact disc player has a digital output jack as well, be sure to also connect it to either a DIGITAL INPUT (COAXIAL) or DIGITAL INPUT (OPTICAL) jack on the DTR-8.2 depending on the type of connector on the compact disc player.

With the initial settings of the DTR-8.2, the CD input source is set for digital input at the OPTICAL 1 jack.

If the digital connection is made at a different jack, this must be changed at the Setup menu: Input Setup → Digital Setup (see page 36).

3. Connecting a cassette tape deck, MD recorder, DAT deck, or CD recorder (TAPE)

Using an RCA-type audio connection cable, connect the output terminals (PLAY) of the device to the TAPE IN jacks on the DTR-8.2 and the input terminals (REC) to the TAPE OUT jacks. Make sure that you properly connect the left channel to the L jack and the right channel to the R jack.

If the device has a digital output jack as well, be sure to also connect it to either a DIGITAL INPUT (COAXIAL) or DIGITAL INPUT (OPTICAL) jack on the DTR-8.2 depending on the type of connector on the device.

With the initial settings of the DTR-8.2, the TAPE input source is set for digital input at the OPTICAL 2 jack.

If the digital connection is made at a different jack, this must be changed at the Setup menu: Input Setup → Digital Setup (see page 36).

Note:

The output from the DIGITAL OUTPUT jack of the DTR-8.2 is only the digital signal input to the DIGITAL INPUT jack.

Connections

 : Signal flow

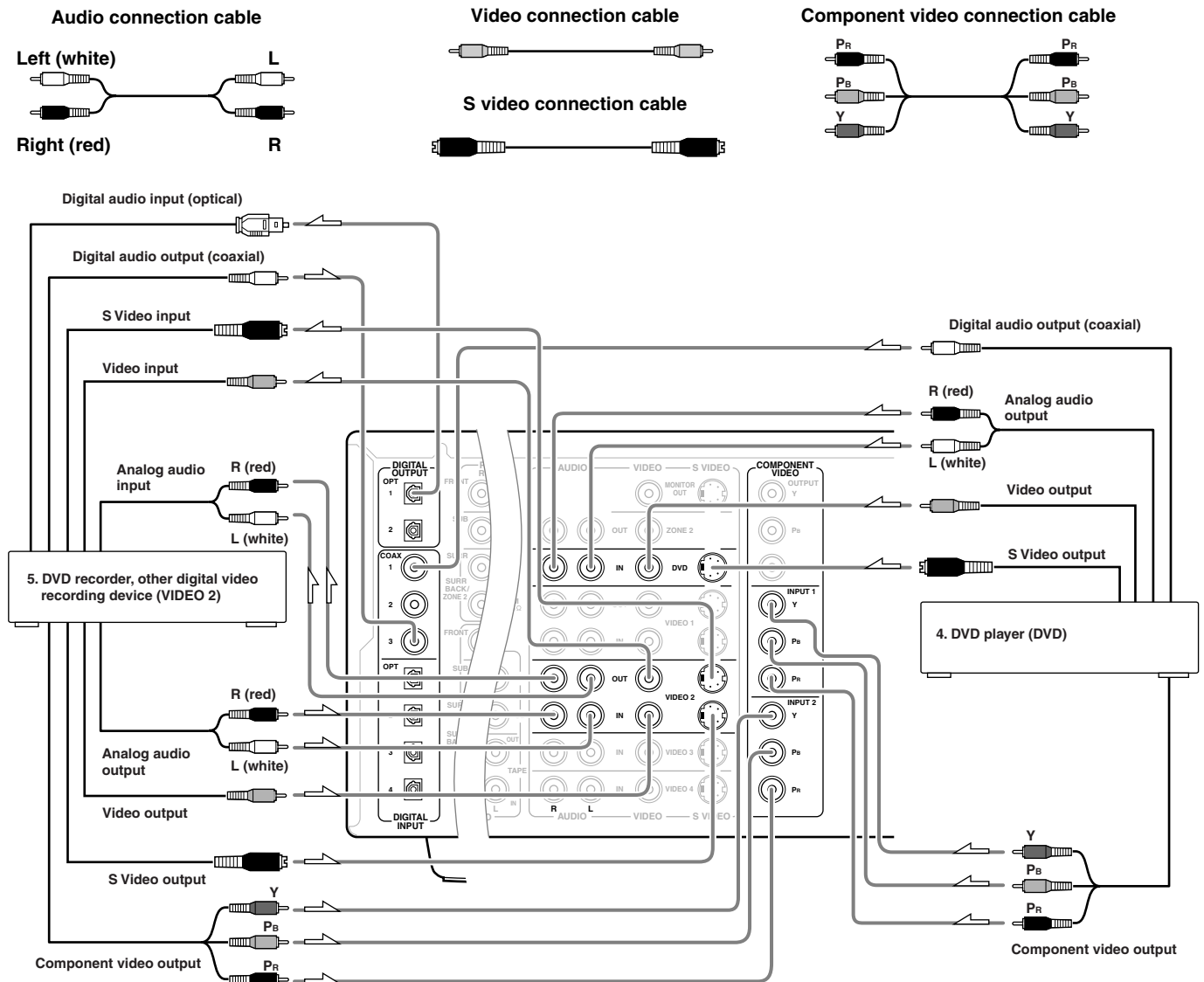

Connecting your video components

Below is an example of how you can connect your video components to the DTR-8.2. Refer to the diagram above for the following connection examples.

The flow of the video signals is as follows:

- The signal that comes in from VIDEO IN is sent to VIDEO OUT and S VIDEO OUT.
- The signal that comes in from S VIDEO IN is sent to S VIDEO OUT and VIDEO OUT.
- The signal that comes in from COMPONENT VIDEO IN is only sent to COMPONENT VIDEO OUT. When connecting a video player to the COMPONENT VIDEO INPUT terminals, be sure to connect your television to the COMPONENT VIDEO OUTPUT terminals.

Note:

If only the video connection for the MONITOR OUT is made, even if the input from each source component is through a component video connection, the picture will not appear. If only the S video connection for the MONITOR OUT is made, the picture will not appear.

4. Connecting a DVD player (DVD)

If the device is equipped with an S video output terminal, connect it to the DVD S VIDEO IN terminal with an S video cable. If it does not have an S video output terminal, connect its video output terminal to the DVD VIDEO IN terminal using an RCA-type video connection cable. You do not need to connect to both the DVD S VIDEO IN and DVD VIDEO IN terminals. If the device has component video outputs, connect them to one of the COMPONENT VIDEO INPUT jacks.

With the initial settings of the DTR-8.2, the DVD input source is set for the COMPONENT VIDEO INPUT 1 jack.

If the video connection is made at COMPONENT VIDEO INPUT 2, this must be changed at the Setup menu: Input Setup → Video Setup → Component Video (see page 38).

Using an RCA-type audio connection cable, connect the audio output terminal on the device to the audio DVD IN jacks on the DTR-8.2. Make sure that you properly connect the left channel to the L jack and the right channel to the R jack.

If the device has a digital output jack as well, be sure to also connect it to either a DIGITAL INPUT (COAXIAL) or DIGITAL INPUT (OPTICAL) jack on the DTR-8.2 depending on the type of connector on the DVD player.

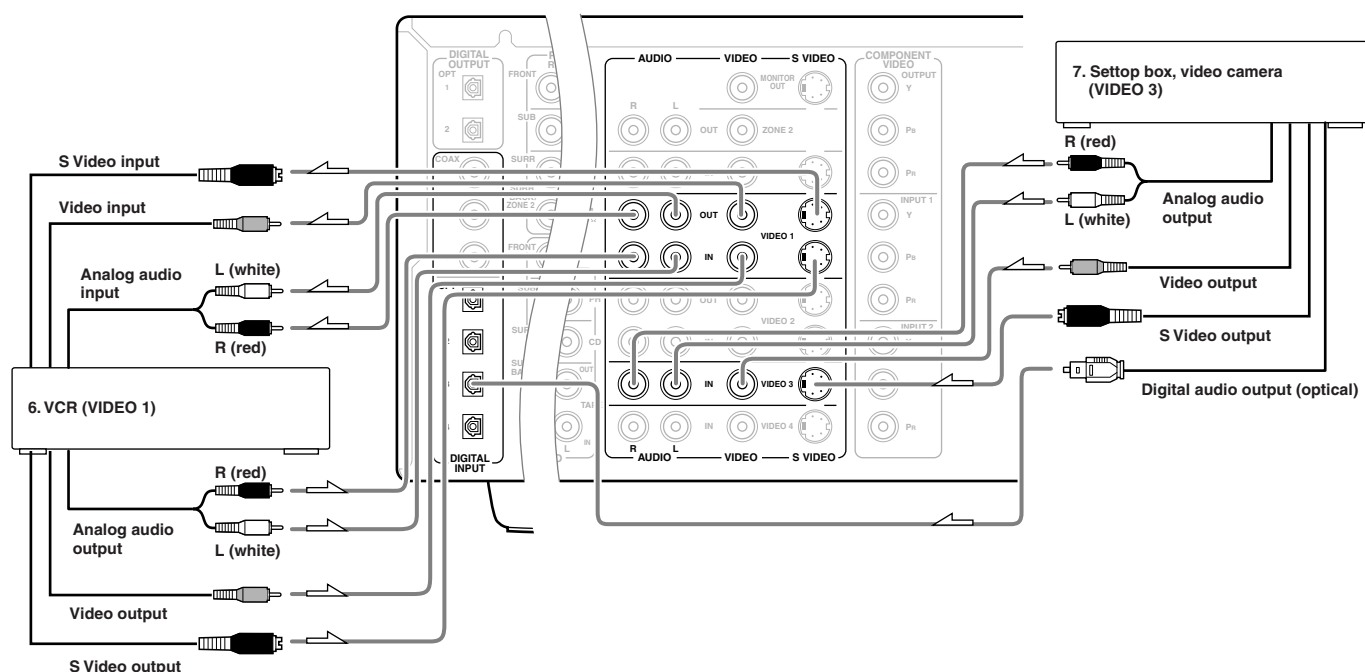

With the initial settings of the DTR-8.2, the DVD input source is set for digital input at the COAXIAL 1 jack.

If the digital connection is made at a different jack, this must be changed at the Setup menu: Input Setup → Digital Setup (see page 36).

5. Connecting a DVD recorder or other digital video recording device (VIDEO 2)

Using an RCA-type video connection cable, connect the video output terminal (composite) on the device to the VIDEO 2 IN jacks on the DTR-8.2 and video input terminal to the VIDEO 2 OUT jacks. If there is an S video input/output terminal on the device, connect it to the S VIDEO 2 IN/OUT jack using an S video cable. You do not need to connect to both the S VIDEO 2 IN and VIDEO 2 IN terminals. If the device has component video outputs, connect them to one of the COMPONENT VIDEO INPUT jacks.

With the initial settings of the DTR-8.2, the VIDEO 2 input source is set for the COMPONENT VIDEO INPUT 2 jack.

If the video connection is made at COMPONENT VIDEO INPUT 1, this must be changed at the Setup menu: Input Setup → Video Setup → Component Video (see page 38).

Using an RCA-type audio connection cable, connect the audio output terminal on the device to the same VIDEO 2 IN audio jacks on the DTR-8.2 and audio input terminal to the VIDEO 2 OUT audio jacks. Make sure that you properly connect the left channel to the L jack and the right channel to the R jack.

If the device has a digital output jack as well, be sure to also connect it to either a DIGITAL INPUT (COAXIAL) or DIGITAL INPUT (OPTICAL) jack on the DTR-8.2 depending on the type of connector on the device.

With the initial settings of the DTR-8.2, the VIDEO 2 input source is set for digital input at the COAXIAL 3 jack.

If the digital connection is made at a different jack, this must be changed at the Setup menu: Input Setup → Digital Setup (see page 36).

If the device also has a digital input jack, it can be connected to the DIGITAL OUTPUT (OPTICAL) jack on the DTR-8.2 for digital recording of the source for REC OUT at the DTR-8.2.

Note:

The output from the DIGITAL OUTPUT jack of the DTR-8.2 is only the digital signal input to the DIGITAL INPUT jack.

6. Connecting a video cassette recorder (VIDEO 1)

Using an RCA-type video connection cable, connect the video output terminal (composite) on the video cassette recorder to the VIDEO 1 IN jacks on the DTR-8.2 and video input terminal to the VIDEO 1 OUT jacks. If there is an S video input/output terminal on the video cassette recorder, connect it to the S VIDEO 1 IN/OUT jack using an S video cable. You do not need to connect to both the S VIDEO 1 IN and VIDEO 1 IN terminals. If the video cassette recorder has component video outputs, connect them to one of the COMPONENT VIDEO INPUT jacks.

With the initial settings of the DTR-8.2, the VIDEO 1 input source is set for the COMPONENT VIDEO INPUT 2 jack.

If the video connection is made at COMPONENT VIDEO INPUT 1, this must be changed at the Setup menu: Input Setup → Video Setup → Component Video (see page 38).

Using an RCA-type audio connection cable, connect the audio output terminal on the video cassette recorder to the same VIDEO 1 IN audio jacks on the DTR-8.2 and audio input terminal to the VIDEO 1 OUT audio jacks. Make sure that you properly connect the left channel to the L jack and the right channel to the R jack.

With the initial settings of the DTR-8.2, the VIDEO 1 input source is set for digital input at the COAXIAL 2 jack.

If the digital connection is made at a different jack, this must be changed at the Setup menu: Input Setup → Digital Setup (see page 36).

Connections

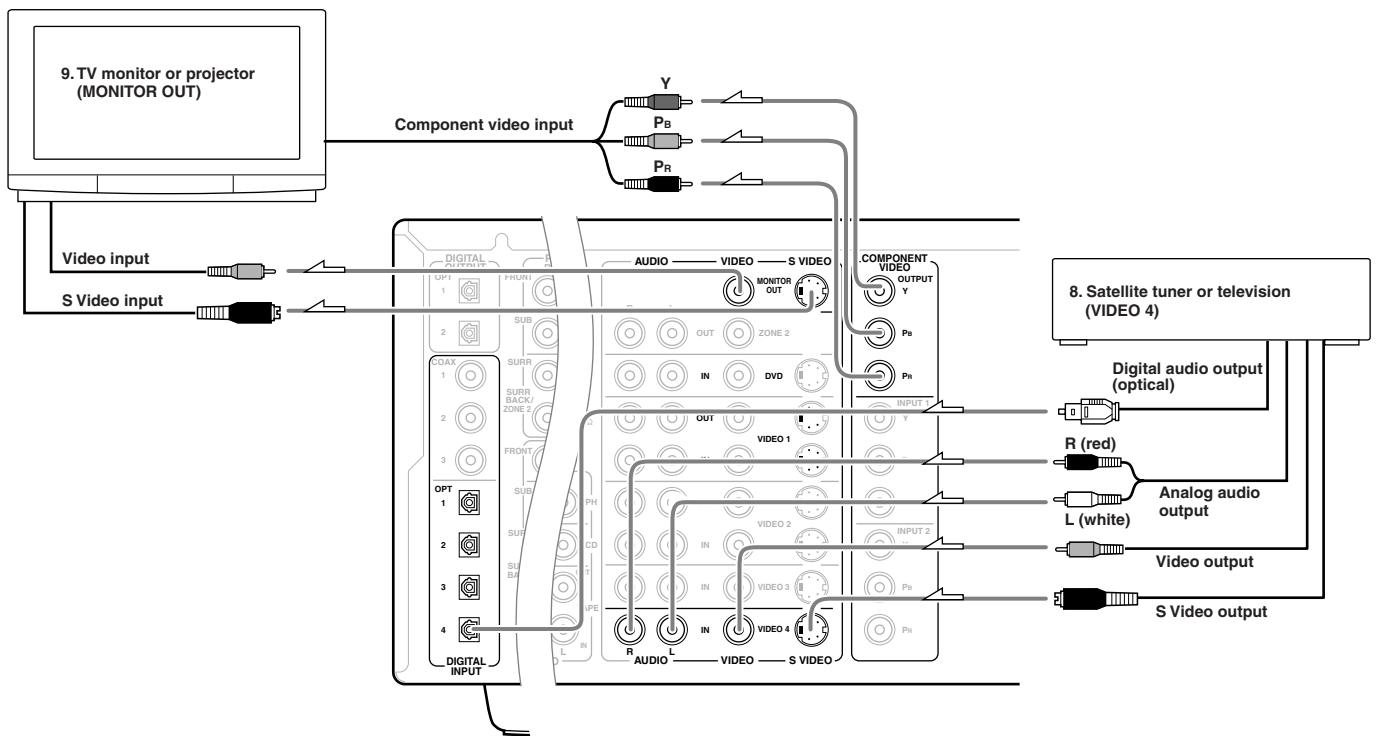

7, 8. Connecting a satellite tuner, television, or settop box (VIDEO 3 or 4)

If the satellite tuner or television is equipped with an S video output terminal, connect it to the S VIDEO 3 (or 4) IN terminal with an S video cable. If it does not have an S video output terminal, connect its video output terminal to the VIDEO 3 (or 4) IN terminal using an RCA-type video connection cable. You do not need to connect to both the S VIDEO 3 (or 4) IN and VIDEO 3 (or 4) IN terminals. If the satellite tuner or television has component video outputs, connect them to one of the COMPONENT VIDEO INPUT jacks.

With the initial settings of the DTR-8.2, the VIDEO 3 and VIDEO 4 input sources are set for the COMPONENT VIDEO INPUT 2 jack.

If the video connection is made at COMPONENT VIDEO INPUT 1, this must be changed at the Setup menu: Input Setup → Video Setup → Component Video (see page 38).

Using an RCA-type audio connection cable, connect the audio output terminal on the satellite tuner or television to the same VIDEO 3 (or 4) IN audio jacks on the DTR-8.2. Make sure that you properly connect the left channel to the L jack and the right channel to the R jack.

If the device has a digital output jack as well, be sure to also connect it to either a DIGITAL INPUT (COAXIAL) or DIGITAL INPUT (OPTICAL) jack on the DTR-8.2 depending on the device.

With the initial settings of the DTR-8.2, the VIDEO 3 input source is set for digital input at the OPTICAL 3 jack, and the VIDEO 4 input source is set for digital input at the OPTICAL 4 jack.

If the digital connection is made at a different jack, this must be changed at the Setup menu: Input Setup → Digital Setup (see page 36).

9. Connecting a television monitor or projector (MONITOR OUT)

The DTR-8.2 is equipped with a simple Y/C separate circuit and simple Y/C mixed circuit. Since both the signal from the S VIDEO and VIDEO inputs are output to the MONITOR OUT S VIDEO output, if the television or projector is equipped with an S video input, it is unnecessary to connect the video connectors. If it is equipped with only a video input, connect it to the MONITOR OUT VIDEO output.

If the monitor or projector is equipped with an S video output terminal, connect it to the MONITOR OUT S VIDEO terminal with an S video cable. If it does not have an S video output terminal, connect its video output terminal to the MONITOR OUT VIDEO terminal using an RCA-type video connection cable. You do not need to connect to both the MONITOR OUT S VIDEO and MONITOR OUT VIDEO terminals. If the device has component video inputs, connect them to the COMPONENT VIDEO OUTPUT jacks.

Note:

Note that the Setup menu will only be displayed on the monitor connected to MONITOR OUT and not those connected to the COMPONENT VIDEO OUTPUT jacks.

10. Connecting video camera, etc. (VIDEO 5)

If the device is equipped with an S video output terminal, connect it to the S VIDEO 5 IN terminal with an S video cable. If it does not have an S video output terminal, connect its video output terminal to the VIDEO 5 IN terminal using an RCA-type video connection cable. You do not need to connect to both the S VIDEO 5 IN and VIDEO 5 IN terminals.

The VIDEO 5 digital input is fixed to the OPTICAL input on the front panel.

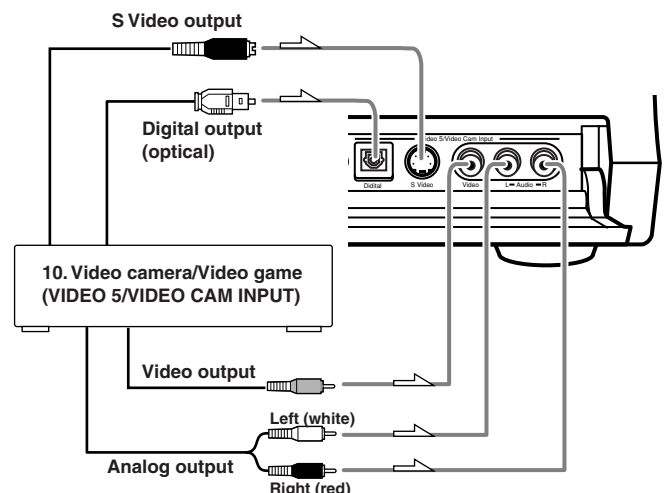

Connecting speakers

Before connecting the speakers, place them correctly by consulting the instruction manuals that came with them.

For surround playback, the configuration and placement of your speakers are very important.

For THX surround EX playback, we recommend that you use a THX speaker system that is certified by Lucasfilm Ltd.

Ideal speaker configuration

- **Front right and left speakers**
- **Center speaker**
Produces a rich sound image by serving as a sound source for the front right and left speakers and enhancing the sonic movement.
- **Surround right and left speakers**
Adds three-dimensional sonic movement and produces environmental sound associated with the background and effect sound for each scene.
- **Surround back right and left speakers**
Required for enjoying THX Surround EX, DTS-ES Matrix 6.1, or DTS-ES Discrete 6.1 audio.
- **Subwoofer**
Produces powerful and heavy bass.

Minimum speaker configuration for surround sound playback

- **Front right and left speakers**
- **Surround right and left speakers**

The sound recorded for the center speaker and the subwoofer will be properly distributed to the front right and left speakers for optimized surround playback.

Speaker placement

Ideal speaker placement varies depending on the size of your room and the wall coverings. Here, only typical example of speaker placement and recommendations are shown.

In order to create the optimum conditions for the best sound quality, be sure to place all the speakers so that the greatest difference between the distances of each speaker to the listening position is less than 6 meters.

Important points regarding speaker placement

Front left and right speakers and center speaker

- Place these three speakers at the same height from the floor.
- Place each speaker so that sound is aimed at the location of the listener's ears when at the listening position.

Surround left and right speakers

- Place these speakers so that their height is 1 meter higher than that of the listener's ears.

Surround back speakers

- Place these speakers behind the listener so that the angle between each speaker and the listener is approximately 30 degrees.
- Place these speakers so that their height is 3 feet (1 meter) higher than that of the listener's ears.

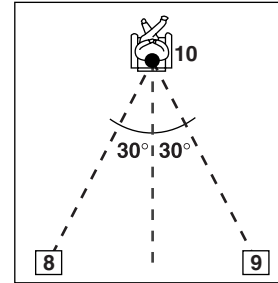

Subwoofer

A subwoofer is recommended for the highest bass effect.

Layout with dipolar speakers

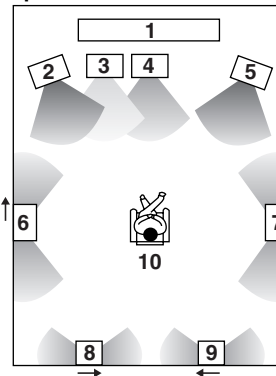

Layout with monopolar speakers

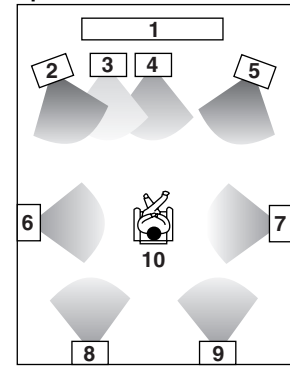

- | | |
|-----------------------|-------------------------------|
| 1 TV or screen | 6 Surround left speaker |
| 2 Front left speaker | 7 Surround right speaker |
| 3 Subwoofer | 8 Surround back left speaker |
| 4 Center speaker | 9 Surround back right speaker |
| 5 Front right speaker | 10 Listening position |

Most dipoles have an arrow on them to indicate their orientation towards the screen. So for the side dipoles, the arrows point forward. For the back dipoles, the arrows should point towards each other to achieve the correct acoustical phasing in the room.

Connecting speakers

Connecting speakers

Caution:
 Connect only speakers with an impedance between 4 and 16 Ω to the DTR-8.2. If the impedance of even one speaker is between 4 and 6 Ω, be sure to set the speaker impedance setting accordingly (see page 31).

- Notes:**
- When you are using only one speaker or when you wish to listen to monaural (mono) sound, a single speaker should never be connected in parallel to both the right and left-channel terminals simultaneously.

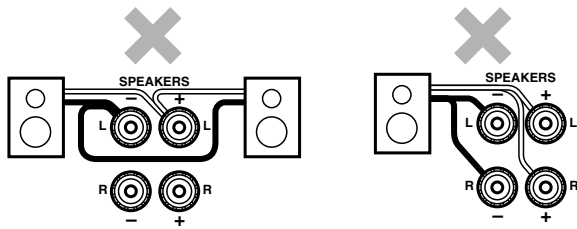

- To prevent damage to circuitry, never short-circuit the positive (+) and negative (-) speaker wire.

NO!

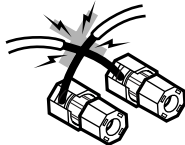

- Be sure to connect the positive and negative cables for the speakers properly. If they are mixed up, the left and right signals will be reversed and the audio will sound unnatural.
- Do not connect more than one speaker cable to one speaker terminal. Doing so may damage the DTR-8.2.
- Connect either your surround back speakers or the speakers you will be using in the remote zone (Zone 2) to the SURR BACK SPEAKERS/ZONE 2 SPEAKERS terminals (see page 24).

Connecting the speaker cable

- Strip away 5/8 inch (15 mm) of wire insulation.
- Twist wire ends very tight.
- Unscrew
- Insert wire
- Screw

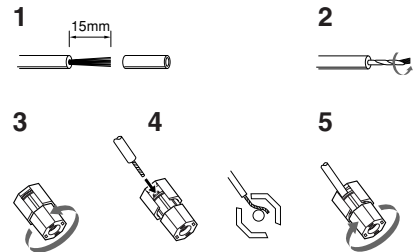

Connecting a subwoofer

Use the PRE OUT SUBWOOFER jack to connect a subwoofer with a built-in power amplifier. If your subwoofer does not have a built-in amplifier, connect an amplifier to the PRE OUT SUBWOOFER jack and the subwoofer to the amplifier.

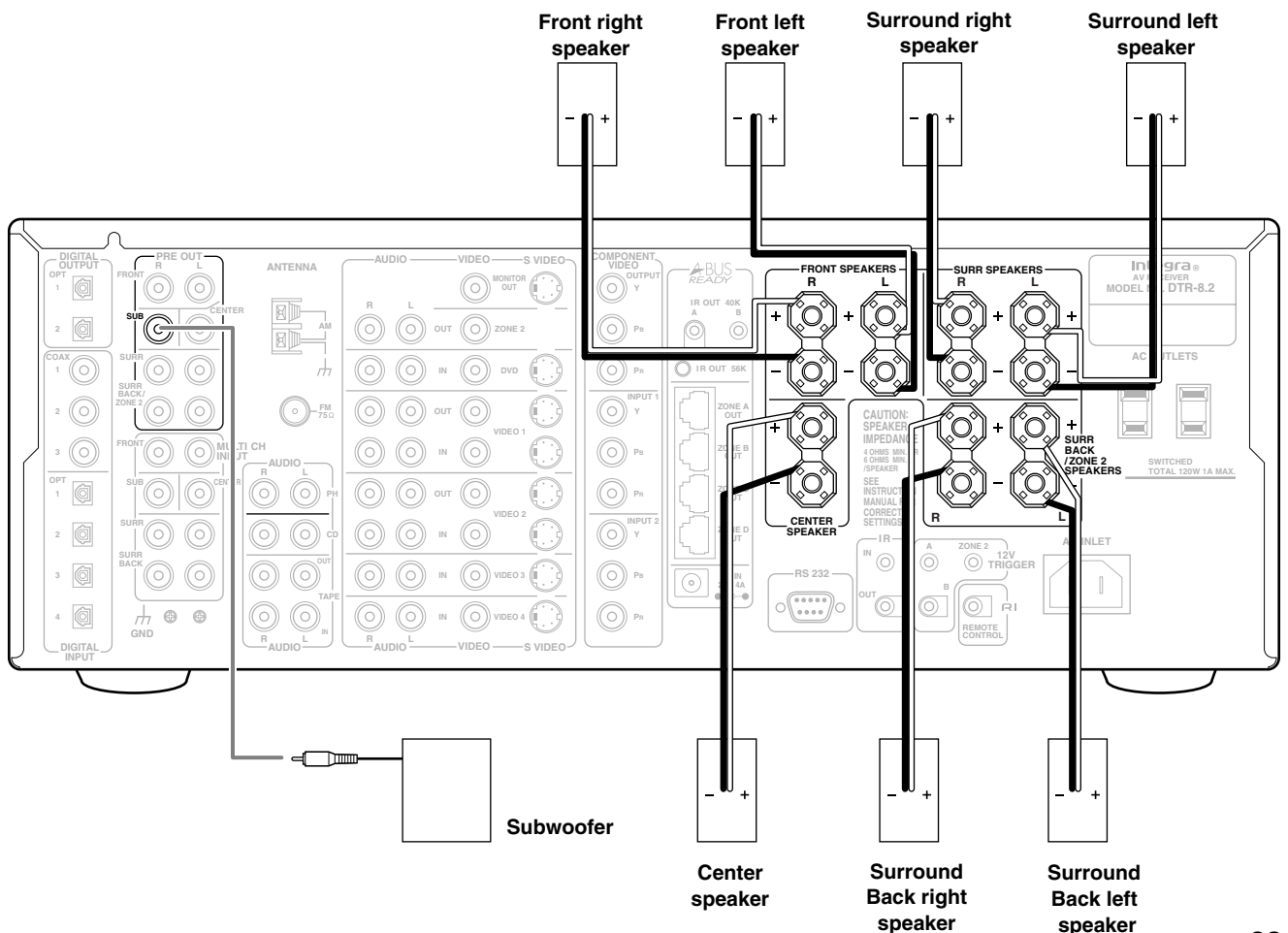

Connecting the remote zone (Zone 2) speakers

Outline

The DTR-8.2 allows you to connect another set of speakers and place them in a different room or separated area for listening to music. This other room or area is referred to as the remote zone (Zone 2), while the room where the DTR-8.2 is located is the main zone. In addition, the IR IN/OUT allows you to control the DTR-8.2 from the remote zone (Zone 2) with the remote controller even though the remote zone is physically separated. The diagram below shows how to make the proper connections for the remote zone.

When using the SURR BACK/ZONE 2 SPEAKERS terminals

If you are using a 5.1-channel speaker system in the main room, you can connect the speakers for the remote zone (Zone 2) to the open SURR BACK/ZONE 2 SPEAKERS terminals.

With this connection, select "Activated" for the Speaker Setup → Powered Zone 2 setting in the Setup menu (See page 32).

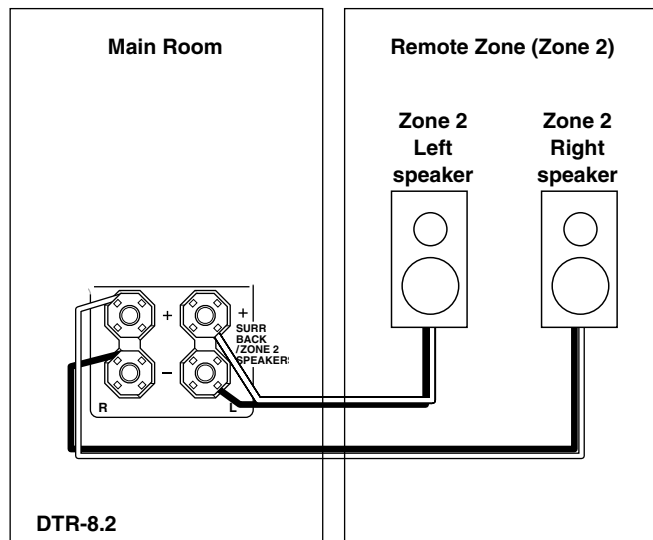

Note:

It is important to be aware of the speaker impedance (see previous page).

When using the SURR BACK/ZONE 2 PRE OUT terminals

If you are using a 5.1-channel speaker system in the main room, you can connect the amplifier for the remote zone (Zone 2) to the open SURR BACK/ZONE 2 PRE OUT terminals and connect the remote zone speakers.

With this connection, select "Activated" for the Speaker Setup → Powered Zone 2 setting in the Setup menu (See page 32).

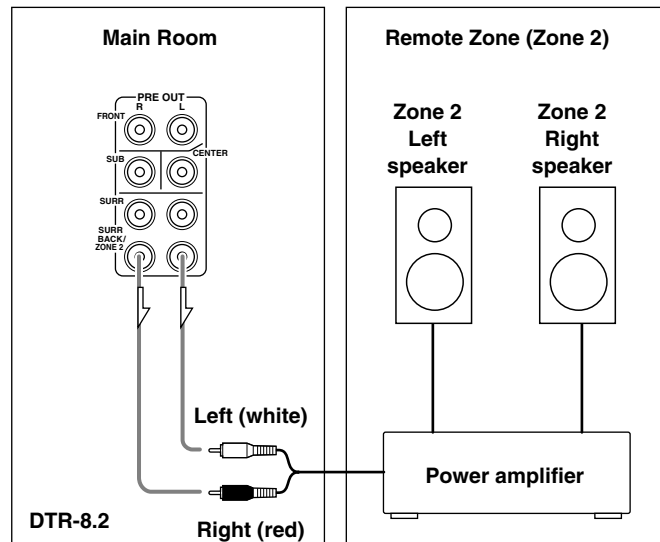

When using the ZONE 2 OUT terminals

When you have connected all the speakers for 7.1-channel audio in the main room, connect the speakers as shown below.

The ZONE 2 OUT terminal is a constant output. Connect to the LINE input of the amplifier (CD, tape, etc.). Adjust the volume with the amplifier connected to the ZONE 2 OUT terminal.

1. Connect the DTR-8.2 to the amplifier for the remote zone.
2. Connect the remote zone speaker cables to the speaker terminals on the amplifier. Adjust the volume level at the amplifier.
3. Connect the DTR-8.2 to the monitor for the remote zone.

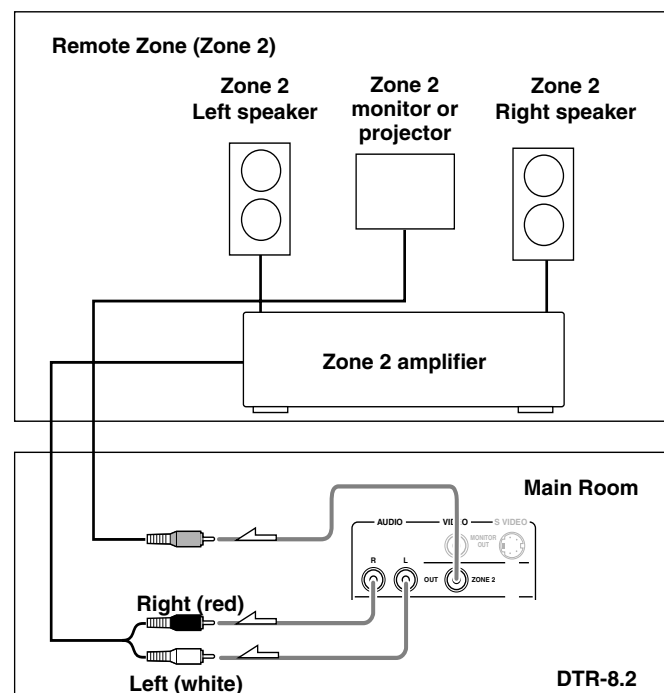

Note:

The ZONE 2 OUT terminals of the DTR-8.2 are of a fixed output level.

Operating components not reached by the remote controller signals (IR IN/OUT)

The following equipment (sold separately) is essential for operation:

- Onkyo's Multi-Room System kits (IR Remote Controller Extension System), or
- Multiroom A/V distribution and control systems from Niles® and Xantech® to name a few

If the remote controller signal does not reach the DTR-8.2 remote sensor

If the DTR-8.2 is located inside a cabinet or other enclosure where the infrared rays from the remote controller cannot enter, then operation with the remote controller will not be possible. In such a case, it will be necessary to install a remote sensor at a location outside of the cabinet for the infrared rays from the controller to reach.

With this connection, select "Main" for the Hardware Setup → IR IN Setup → Position setting in the Setup menu (see page 31).

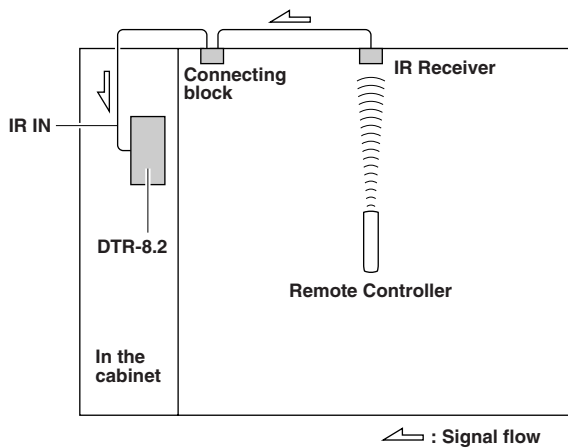

The IR IN input allows you to control the DTR-8.2 from the remote zone (Zone 2) with the remote controller even though the remote zone is physically separated.

The diagram below shows how to make the proper connections for the remote zone.

With this connection, select "Zone 2" for the Hardware Setup → IR IN Setup → Position setting in the Setup menu (see page 31).

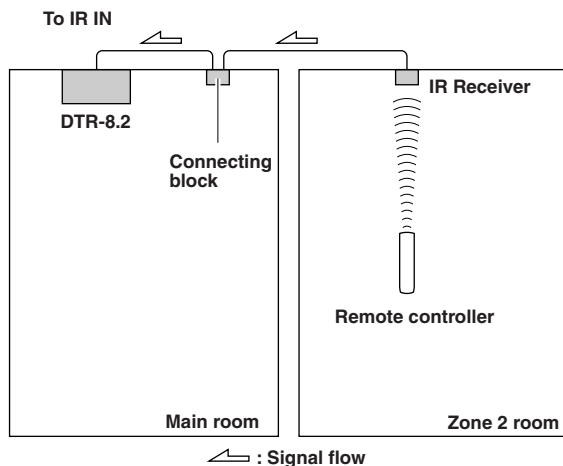

Make connection as shown below. Do not plug the equipment into the power source until the connection is complete.

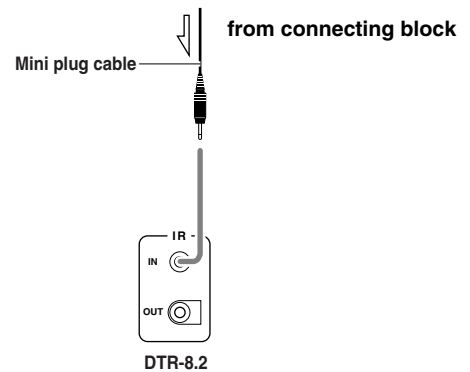

If the remote controller signal does not reach other components

In this situation, you will need to use a commercially available IR emitter. Connect the mini plug of the IR emitter to the IR OUT terminal on the DTR-8.2 and then place the IR emitter on the remote sensor of the component or facing it. When the IR emitter is connected, only the signal input to the IR IN terminal is output to the IR OUT terminal. The signal input from the remote sensor on the front of the DTR-8.2 will not be output to the IR OUT terminal.

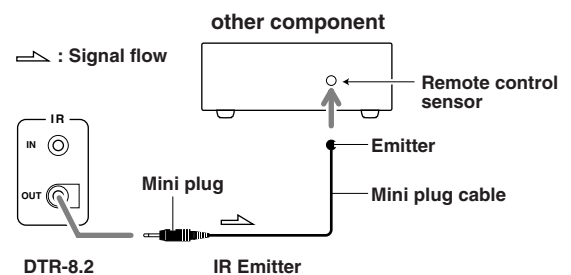
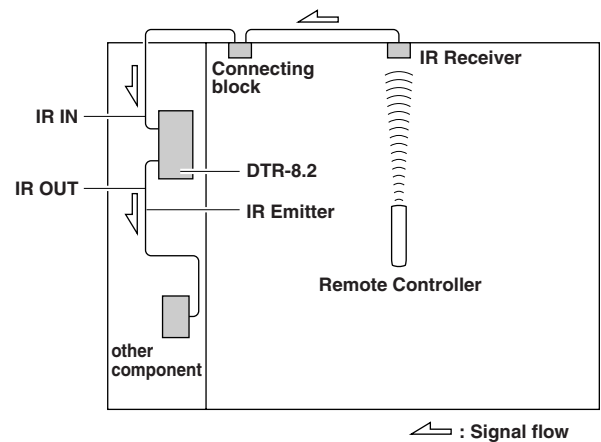

Connecting antennas

To use the tuner of DTR-8.2, it is necessary to prepare the supplied FM and AM antennas.

- Adjustment and placement of the FM and AM antennas for better reception must be done while listening to a station broadcast.
- If better reception cannot be obtained, then placement of an outside antenna is recommended.

Assembling the AM loop antenna

Assemble the loop antenna as shown in the illustration.

- Refer to “Connecting the AM loop antenna” below for details on connecting the loop antenna.

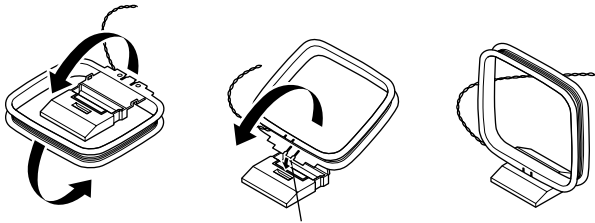

Insert into the hole.

Connecting the AM antenna cable

1. Press down the lever.
2. Insert the wire into the hole.
3. Release the lever.

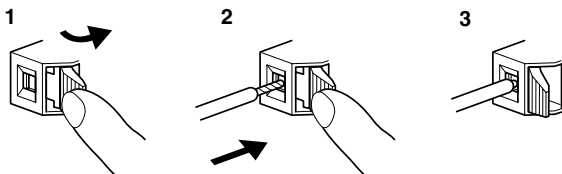

Connecting the included antennas

Connecting the FM indoor antenna:

The FM indoor antenna is for indoor use only. During use, extend the antenna and move it in various directions until the clearest signal is received. Fix it with push pins or similar implements in the position that will cause the least amount of distortion.

If the reception is not very clear with the attached FM indoor antenna, the use of an outdoor antenna is recommended.

Connecting the AM loop antenna:

The AM loop antenna is for indoor use only. Set it in the direction and position where you receive the clearest sound. Put it as far away as possible from the DTR-8.2, televisions, speaker cables, and power cords.

When reception is not satisfactory with the attached AM loop antenna alone, connection of an outdoor antenna is recommended.

FM antenna

(Indoor) AM loop antenna

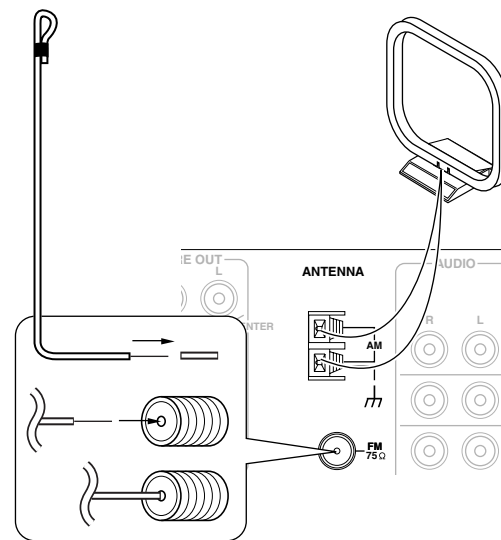

Strip away the insulation from the end of the cable, then fully insert the stripped end of the cable.

Hint:

Either of the split ends of the AM antenna can be connected to either terminal. Unlike speaker cabling, there is no polarity for AM broadcast signals.

Connecting antennas

Connecting an FM outdoor antenna

Please make sure that you follow the considerations:

- Keep the antenna away from noise sources (neon signs, busy roads, etc.).
- It is dangerous to put the antenna close to power lines. Keep it well away from power lines, transformers, etc.
- To avoid the risk of lightning and electrical shock, grounding is necessary. Follow item 14 of the “Important Safeguards” on page 2 when you install the outdoor antenna.

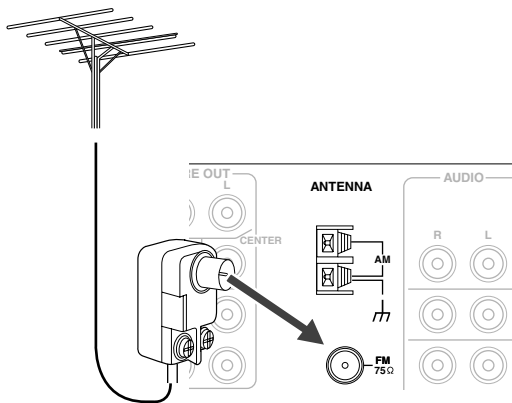

Directional linkage

Do not use the same antenna for both FM and TV (or VCR) reception since the FM and TV (or VCR) signals can interfere with each other. If you must use a common FM/TV (or VCR) antenna, use a directional linkage type splitter.

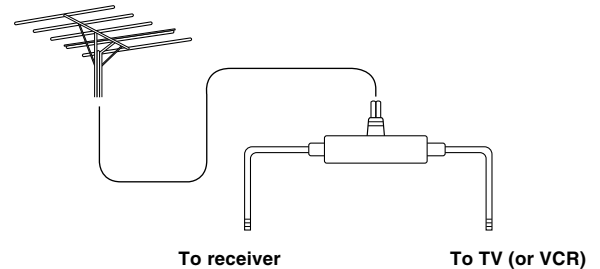

Connecting an AM outdoor antenna

An outdoor antenna will be more effective if it is stretched horizontally above a window or outside.

- Do not remove the AM loop antenna.
- To avoid the risk of lightning and electrical shock, grounding is necessary. Follow item 14 of the “Important Safeguards” on page 2 when you install the outdoor antenna.

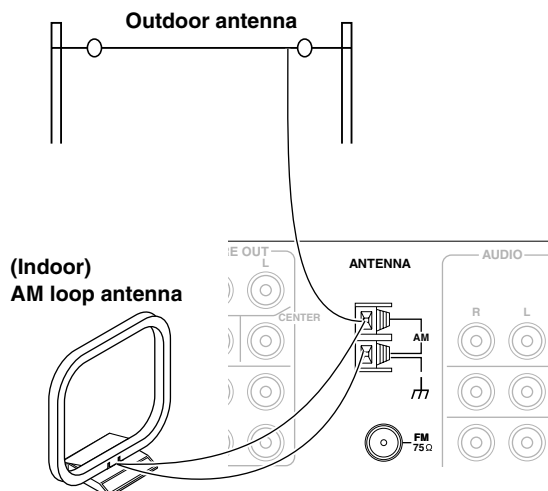

Connecting the power

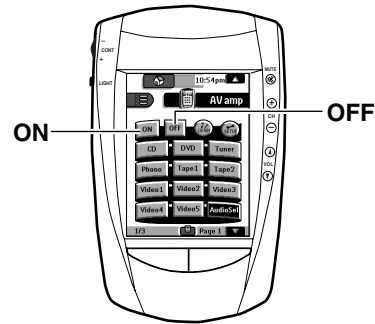
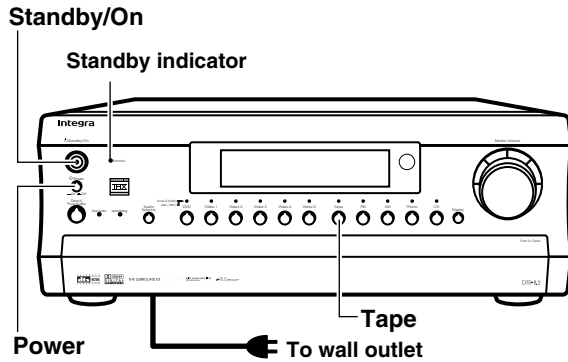

- The DTR-8.2 is shipped with the main power (Power) switch in the on position (On). When the power cord is plugged in for the first time, the DTR-8.2 will automatically enter the standby state and the Standby indicator will light (same condition after step 2 below).
- Before you plug in the DTR-8.2, confirm that all connections have been made properly.
- Turning on the power may cause a momentary power surge, which might interfere with other electrical equipment on the same circuit, such as computers. If this happens, use a wall outlet on a different circuit.

To change the display of the input source from TAPE to MD:

If you connected an MD recorder to the TAPE jack on the DTR-8.2, you can have "MD" appear when the Tape source button is pressed. By changing the display, if an Integra/Onkyo MD recorder **RI**-connected, the **RI** system functions will become enabled.

Changing the display:

Press and hold down the Tape source button until the display changes from TAPE to MD (approx. 3 seconds).

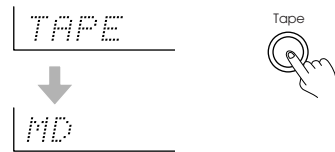

To return the display to its original setting, perform the same procedure. This setting is necessary to allow **RI** system functions for the connected cassette tape or MD recorder.

1. Plug the power cord into an AC wall outlet.

2. Press the Power switch to set the DTR-8.2 to standby state.

The STANDBY indicator will light up.

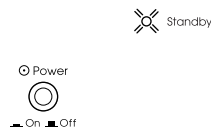

3. Press the Standby/On button to turn on the DTR-8.2. The display and four jog dial indicators will light up and the Standby indicator will turn off.

If you press the Standby/On button again, the receiver returns to Standby mode.

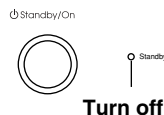

Turning the power on from the remote controller:

Before you can use the remote controller, you must perform steps 1 and 2 above and place the DTR-8.2 in the standby state.

1. Select AV Amp in the Home menu.

2. Tap the ON button.

To return the DTR-8.2 to the standby state, press the OFF button.



Memory preservation

This unit does not require memory preservation batteries. A built-in memory power backup system preserves the contents of the memory during power failures and even when the POWER switch is set to off. The POWER switch must be set to on in order to charge the backup system.

The memory preservation period after the unit has been turned off varies depending on climate and placement of the unit. On the average, memory contents are protected over a period of a few weeks after the last time the unit has been turned off. This period is shorter when the unit is exposed to a highly humid climate.

Setup menus

When making the various settings required to configure your DTR-8.2 optimally, you can either use the OSD menu that appears on your television monitor or you can use the display on the front of the DTR-8.2. The OSD menu is a settings menu that is displayed on your TV monitor. For use as reference when performing the setting procedures, this manual shows both the OSD menu displayed on your television monitor and the display on the front of the DTR-8.2.

The Setup menu consists of a main screen that is divided up into 5 menus: Hardware Setup, Speaker Setup, Input Setup, Audio Adjust, and Preference. These menus are then divided up into various sub-menus, and these contain settings for you to optimize your home theater as you wish.

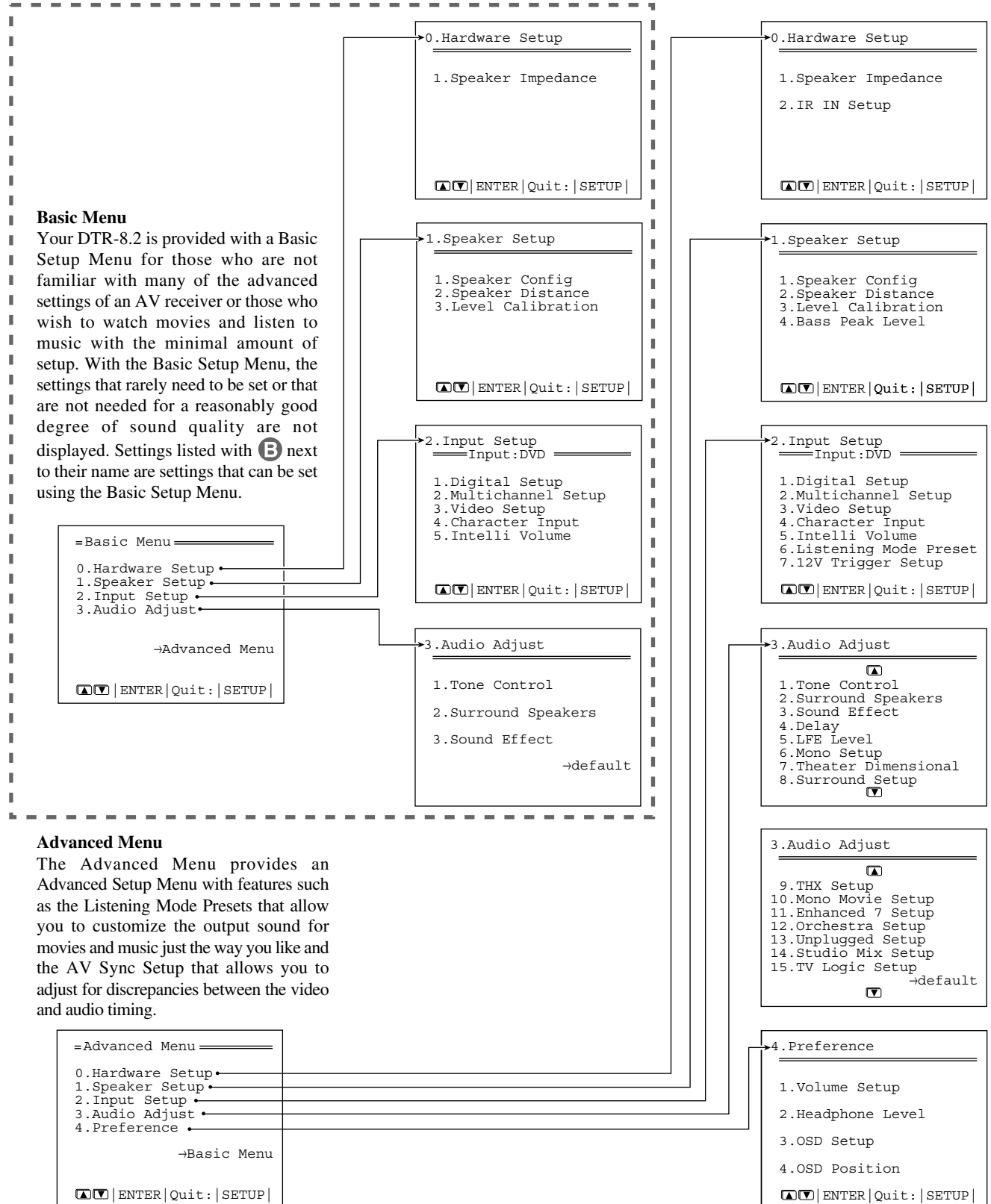



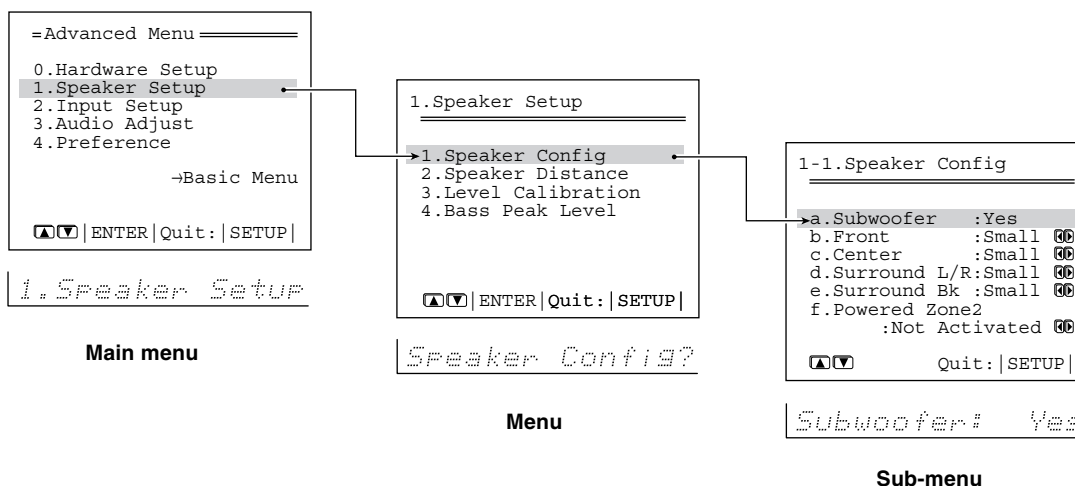











Setup menus



Navigating through the Setup menu

You can change settings using the buttons on the front panel and on the remote controller.

The buttons on the remote controller correspond to those on the DTR-8.2 as shown below.

Button on remote controller	Button on DTR-8.2
 Setup	 Setup
 Up	 Up
 Down	 Down
 Left	 Left
 Right	 Right
 Enter	 Enter
 Return	 Return

When using the buttons on the front panel

- Press the Setup button.**
The main menu screen of the Main menu appears on your TV monitor.
- Using the ▲ and ▼ cursor buttons, select the menu that you want to enter.**
- Press the Enter button to enter the selected menu.**
The screen for that menu appears.
- Using the ▲ and ▼ cursor buttons, select the sub-menu that you want to enter, and press the Enter button.**
Each sub-menu has different settings that can be changed as desired, and they are all explained below. To change a setting, first select it using the ▲ and ▼ cursor buttons, and then change the setting using the ◀ and ▶ cursor buttons.
- Press the Return button to set the new settings and return to the previous menu screen, and again to return to the main screen.**

Note:

Press the Setup button to exit the Setup menu immediately.

When using the remote controller

- Select AV Amp in the Home menu.**
- Tap the down scroll button twice to display the third operation menu.**
- Perform steps 1 to 5 given above.**
You can perform the same operation using the buttons on the remote controller that correspond to those on the front panel.

Hardware Setup

0. Hardware Setup menu

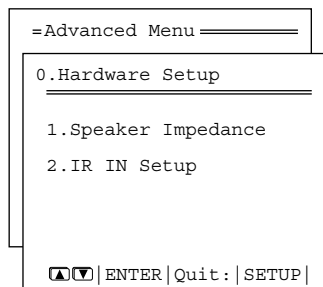

0. HardwareSetup

The Hardware Setup menu will need to be set before you use your DTR-8.2 for the first time. Once you set the Speaker Impedance setting at the Hardware Setup menu, the setting will not be displayed again when you enter the Basic Menu. To change the setting at a later date, select the Advanced Menu to display the Hardware Setup menu.

0-1. Speaker Impedance sub-menu **B**

Set the impedance level to match the specifications of the speakers you are using.

If the impedances of all speakers are between 6 and 16 Ω , select "6 ohms." If the impedance of even one speaker is between 4 and 6 Ω , select "4 ohms."

Note:

Before you change this setting, be sure to first lower the volume at the DTR-8.2 to the minimum level.

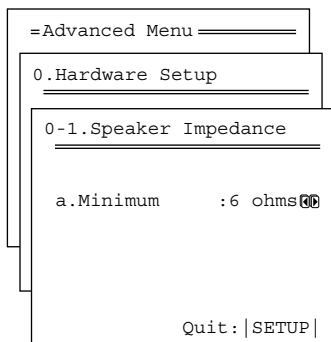

Sp Impedance?

0-2. IR IN Setup sub-menu

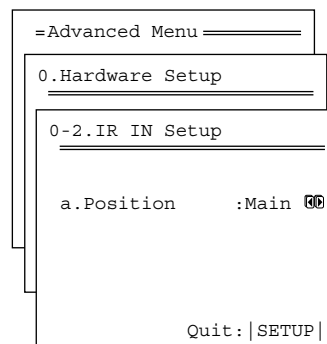

IR IN Setup?

This sub-menu allows you to set where you will be using the remote controller when you are using it in conjunction with the IR IN terminal (i.e. remote controller signals are input at the IR IN terminal).

Main: Select when you have a remote sensor for the remote controller connected to the IR IN terminal in the main room.

Zone 2: Select to perform the remote zone (Zone 2) operations from the remote zone.

Speaker Setup

1. Speaker Setup menu

After you have installed the DTR-8.2, connected all the components, and determined the speaker layout, it is now time to perform the settings in the Speaker Setup menu for the optimum sound acoustics for your environment and speaker layout.

Before you perform the following settings, it is important that you first determine the following characteristics:

- The types and sizes of the speakers that are connected.
- The distance from each speaker to your normal listening position.

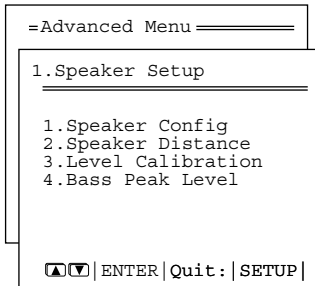

1. Speaker Setup

Memo:

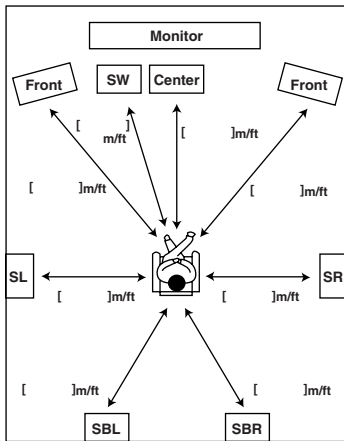

Tip:

When setting the speaker size in the Speaker Config sub-menu, use the guidelines given below.

Large: The complete frequency range for the channel you are setting will be output from the speaker.

Small: Frequencies of the channel you are setting lower than 80 Hz will be output from the subwoofer. If there is no subwoofer, then the output will be from the left and right front speakers. (Set all speakers for THX speaker systems to “small.”)

1-1. Speaker Config sub-menu B

Here you will enter which speakers are connected and the size of each speaker.

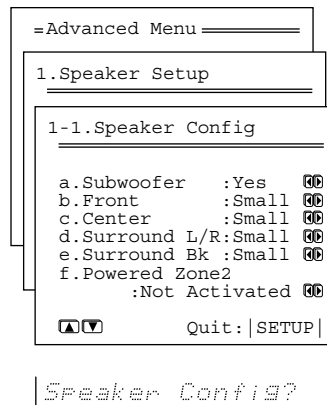

Speaker Config?

a. Subwoofer

Yes: Select when a subwoofer is connected.

No: Select when a subwoofer is not connected.

b. Front

Large: Select if the front speakers are large sized.

Small: Select if the front speakers are small sized.

- If “No” is selected for the Subwoofer setting, then this setting is fixed to “Large.”

c. Center

None: Select if no center speaker is connected.

Large: Select if the center speaker is large sized.

Small: Select if the center speaker is small sized.

- If “Small” is selected for the Front setting, then “Large” cannot be selected for this setting.

d. Surround L/R

None: Select if no surround left and right speakers are connected.

Large: Select if the surround left and right speakers are large sized.

Small: Select if the surround left and right speakers are small sized.

- If “Small” is selected for the Front setting, then “Large” cannot be selected for this setting.

e. Surround Bk

None: Select if no surround back left and right speakers are connected.

Large: Select if the surround back left and right speakers are large sized.

Small: Select if the surround back left and right speakers are small sized.

- If “None” is selected for the Surround L/R setting, the display disappears from the screen.
- If “Small” is selected for the Surround L/R setting, then “Large” cannot be selected for this setting.
- If “Activated” is selected for the Powered Zone 2 setting (below), then the display disappears from the screen.

f. Powered Zone 2

Activated: Select when connecting the speakers for the remote zone (Zone 2) to the SURR BACK/ZONE 2 PRE OUT or SURR BACK/ZONE 2 SPEAKERS terminals (using the internal amplifier of the DTR-8.2).

Not Activated: Select when not connecting the speakers for the remote zone (Zone 2) to the SURR BACK/ZONE 2 PRE OUT or SURR BACK/ZONE 2 SPEAKERS terminals (not using the internal amplifier of the DTR-8.2).

Speaker Setup

Note:

The SURR BACK/ZONE 2 PRE OUT and SURR BACK/ZONE 2 SPEAKER terminals

In order to have 7.1-channel playback in the main room, you must set the Powered Zone 2 setting to "Not Activated." When set to "Not Activated," the surround back signals are output from the SURR BACK/ZONE 2 PRE OUT and SURR BACK/ZONE 2 SPEAKER terminals. Connect the surround back speakers to the SURR BACK/ZONE 2 SPEAKER terminals or to the speakers terminals of the power amplifier connected to the SURR BACK/ZONE 2 PRE OUT terminals.

When you are not using the surround back speakers in the main room and using the internal amplifier to power the speakers for the remote zone (Zone 2), set the Powered Zone 2 setting to "Activated." When set to "Activated," the Zone 2 signals are output from the SURR BACK/ZONE 2 PRE OUT and SURR BACK/ZONE 2 SPEAKER terminals. Connect the remote zone (Zone 2) speakers to the SURR BACK/ZONE 2 SPEAKER terminals or to the speakers terminals of the power amplifier connected to the SURR BACK/ZONE 2 PRE OUT terminals.

1-2. Speaker Distance sub-menu **B**

Here you will enter the distance from each speaker to your normal listening position. This is important for the timing of the acoustics to create the proper sound space that the DTR-8.2 and today's sound systems are able to produce.

Notes:

- Speakers that you selected "No" or "None" for in the Speaker Config sub-menu will not appear.
- The difference between the distances of different speakers cannot be set to more than 20 feet.

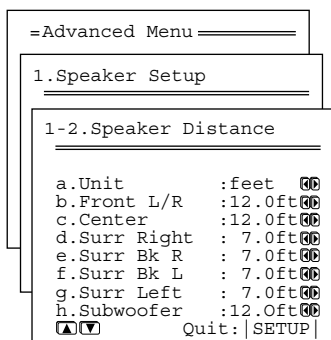

Sp Distance? _____

a. Unit

feet: Select if you will enter the distances in feet.

meters: Select if you will enter the distances in meters.

b. Front L/R

Set the distance from the front left and right speakers to your normal listening position between 1 and 30 feet in 0.5-foot intervals (0.3 to 9 meters in 0.15-meter intervals).

Position the front left and right speakers so that they are the same distance from the listener. If they are not, you may lose the center position for stereo sound.

c. Center

Set the distance from the center speaker to your normal listening position between 1 and 30 feet in 0.5-foot intervals (0.3 to 9 meters in 0.15-meter intervals).

d. Surr Right

Set the distance from the surround right speaker to your normal listening position between 1 and 30 feet in 0.5-foot intervals (0.3 to 9 meters in 0.15-meter intervals).

e. Surr Bk R

Set the distance from the surround back right speaker to your normal listening position between 1 and 30 feet in 0.5-foot intervals (0.3 to 9 meters in 0.15-meter intervals).

f. Surr Bk L

Set the distance from the surround back left speaker to your normal listening position between 1 and 30 feet in 0.5-foot intervals (0.3 to 9 meters in 0.15-meter intervals).

Note:

If the Powered Zone 2 setting of the Speaker Config sub-menu is set to "Activated," then the Surr Bk R and Surr Bk L settings will not be displayed.

g. Surr Left

Set the distance from the surround left speaker to your normal listening position between 1 and 30 feet in 0.5-foot intervals (0.3 to 9 meters in 0.15-meter intervals).

h. Subwoofer

Set the distance from the subwoofer to your normal listening position between 1 and 30 feet in 0.5-foot intervals (0.3 to 9 meters in 0.15-meter intervals).

Speaker Setup

1-3. Level Calibration sub-menu **B**

Here you will set the volume for each speaker so that they are all heard by the listener at the same level. This is especially important for speaker layouts where the left and right speakers are at different distances or in asymmetrical positions due to room designs and configurations. These settings and the distance settings performed above are vital to create the proper acoustics required for the optimum sound space and dynamics.

Note:

The speaker level settings here are not effective for multichannel input sources. To adjust the speaker levels for multichannel input sources, you will need to use the CH Sel, + and – buttons on the USR-5 remote controller. See page 55.

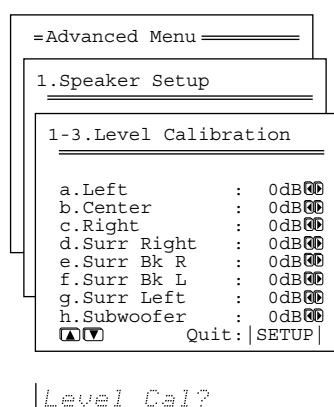

Calibrating the speaker levels

- (1) When this sub-menu is entered, the DTR-8.2 will emit a pink noise from the front left speaker. At this time, the Master volume automatically increases to the reference level (0dB). Remember the level of this noise and then press the ▼ cursor button. (Note that this can be adjusted to any level between –12 and 12 decibels in 1-decibel intervals.) The DTR-8.2 will now emit the pink noise from the center speaker.
- (2) Using the ◀ and ▶ cursor buttons, adjust the volume level of the noise from the center speaker so that it is the same level as the front left speaker. You can jog back and forth between the speakers to help you compare the volume levels.
- (3) Press the ▼ cursor button again. The DTR-8.2 will now emit the pink noise from the front right speaker.
- (4) Repeat steps (2) and (3) above for the front right and other speakers until all speakers are adjusted to the same volume level.

Notes:

- Speakers that you selected “No” or “None” for in the Speaker Config sub-menu will not appear.
- To accurately set the output levels, it is recommended to use a handheld sound pressure level (SPL) meter. Set the meter to C-weighting and slow averaging. A Radio Shack® SPL meter or equivalent is recommended. Using the internal channel noise generators, set each channel so that you read a 75 decibel sound pressure level.

a. Left

Sound comes from the front left speaker. Adjust the sound level between –12 and 12 decibels in 1-decibel intervals.

b. Center

Sound comes from the center speaker. Adjust the sound level between –12 and 12 decibels in 1-decibel intervals.

c. Right

Sound comes from the front right speaker. Adjust the sound level between –12 and 12 decibels in 1-decibel intervals.

d. Surr Right

Sound comes from the surround right speaker. Adjust the sound level between –12 and 12 decibels in 1-decibel intervals.

e. Surr Bk R

Sound comes from the surround back right speaker. Adjust the sound level between –12 and 12 decibels in 1-decibel intervals.

f. Surr Bk L

Sound comes from the surround back left speaker. Adjust the sound level between –12 and 12 decibels in 1-decibel intervals.

Note:

If the Powered Zone 2 setting of the Speaker Config sub-menu is set to “Activated,” then the Surr Bk R and Surr Bk L settings will not be displayed.

g. Surr Left

Sound comes from the surround left speaker. Adjust the sound level between –12 and 12 decibels in 1-decibel intervals.

h. Subwoofer

Sound comes from the subwoofer. Adjust the sound level between –15 and 12 decibels in 1-decibel intervals.

Speaker Setup

1-4. Bass Peak Level (Bass Peak Level Manager*) sub-menu

Setting the bass peak level is important to keep your subwoofer from being damaged by preventing it from outputting over a set volume. If your subwoofer has a built-in limiter, set this setting to "Off."

Note:

If your system does not include a subwoofer, this setting will set the bass peak level for your front speakers.

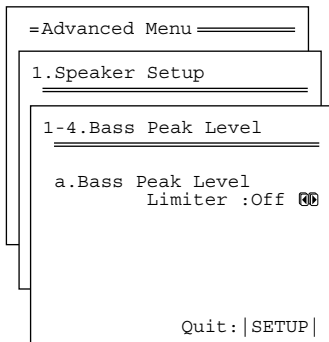

Bass Peak Lvl?

a. Bass Peak Level Limiter

On: Select to set the bass peak level. When "On" is selected, the Peak Level setting appears below.

Off: Select to turn off the bass peak level limiting function.

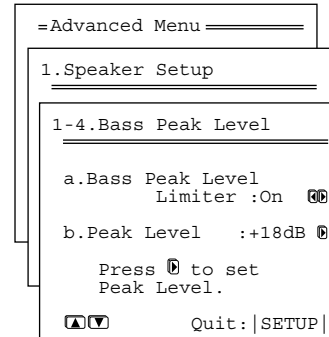

BassLimiter#On

b. Peak Level

The current bass peak level is displayed. Press the ► cursor button to output a test sound. Then press the ► cursor button (or turn the Master Volume dial) to slowly raise the volume to the point where the sound becomes distorted and then back it off until it returns to normal. This is the proper setting for the bass peak level.

After setting the Peak Level at the Bass Peak Level sub-menu, press the Return button. The values are set and the previous screen appears.

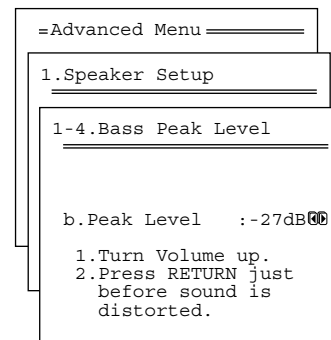

BassPeakLvl#-27.

Notes:

- The volume can be adjusted to either $-\infty$ or between -81 to $+18$ decibels in 1-decibel increments.
- Do not allow the distorted sound to be output from the subwoofer for a long time for it may damage the subwoofer.

* Bass Peak Level Manager is a registered trademark of Lucasfilm Ltd.

Input Setup

2. Input Setup menu

This menu allows you to setup the various input sources available with the DTR-8.2. Each input source may have a great number of settings that are difficult to keep track of, so we recommend making a chart to record what you have set and for which component to prevent confusion later.

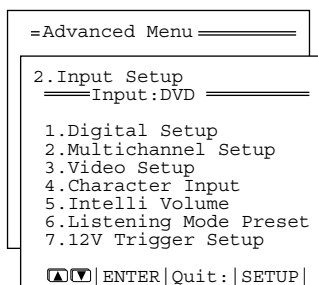

2. Input Setup

2-1. Digital Setup sub-menu B

The settings made in this sub-menu are valid for the input source that is currently selected with the input source buttons at the front panel and, therefore, these settings are made separately for each digital input source. This sub-menu will not appear if the selected input source button is AM or FM. If this setting is incorrectly made, the digital audio signals may not be properly output, or not heard at all. Also, since VIDEO 5 is fixed to the optical digital terminal on the front panel, this sub-menu will not appear if VIDEO 5 is selected.

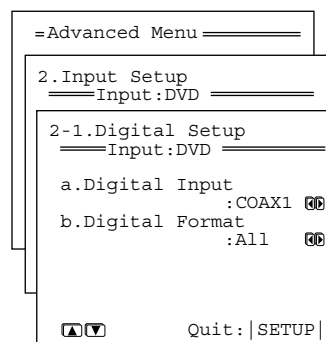

Digital Setup?

Initial settings for each input source

Input source	Digital input
CD	OPTICAL 1
PHONO	----
FM	/
AM	/
TAPE	OPTICAL 2
VIDEO 1	COAXIAL 2
VIDEO 2	COAXIAL 3
VIDEO 3	OPTICAL 3
VIDEO 4	OPTICAL 4
VIDEO 5	OPTICAL on front panel (fixed)
DVD	COAXIAL 1

---- : Available for digital input but not set in initial settings.

: Not available for digital input.

Input Setup

a. Digital Input

This setting tells the DTR-8.2 which input source button on the front panel is connected with which digital input jack on the rear panel. To perform this setting, you must first select a digital input source at the front panel and then set the name of the digital input jack it is connected to here.

For example, if the input source selected at the front panel is CD and the compact disc player is connected to DIGITAL INPUT (OPT) 1, then select "OPT1" here. If the input source selected is not connected to a digital input, then select "----."

OPT1-4: Connect your digital components to any of the DIGITAL INPUT (OPT) terminals 1 through 4.

COAX1-3: Connect your digital components to any of the DIGITAL INPUT (COAX) terminals 1 through 3.

----: Select if the input source is not from a digital input jack.

b. Digital Format

Sets the digital signal type to which priority is given during signal detection at the selected digital terminal.

The default setting is "All." If "----" is selected for this input source at the Digital Input setting, then this setting will not appear. Although you can use this default setting as is, you may change it as desired depending on the input signal format (e.g., if you know that you will always be listening to a certain input signal format from a particular input source).

All: Select for automatic detection of the input signal format. The input signal format (Dolby Digital, DTS, PCM or Analog) used by the selected input source is detected automatically to execute the required decoding process.

DTS: Select for DTS signal processing. The decoding process is executed only when DTS signals are input.

PCM: Select for PCM signal processing. The decoding process is executed only when PCM signals are input.

Notes:

- If "All" is selected and a compact disc or LD is fast-forwarded during playback, decoded PCM signals may produce a skipping sound. In such cases, change the setting to "PCM."
- If a DTS signal is not input when "DTS" is selected, the DTR-8.2 does not automatically switch to analog output even if "Auto" is selected with the Audio Selector button.

Notes on DTS:

- If you play a CD or LD that supports DTS when the "PCM" setting is selected on the DTR-8.2, the DTS encoded signal will not be decoded and noise will be output. This noise could damage the amplifier and speakers. Therefore, be sure to select "All" or "DTS" and use the digital input jacks (OPTICAL or COAXIAL) to connect the DTS source.
- If you play a CD or LD that supports DTS when "All" is selected, you may hear a noise for a short while until the DTS decoder recognizes the DTS-encoded signal and starts operating. This is not a malfunction.
- If you press the pause or skip button on the player while playing a DTS source, a short noise may be heard. This is not a malfunction. In such cases, try playing the source in the "DTS" selected.
- The DTS indicator on the DTR-8.2 lights while a DTS source is played. When playback finishes and the DTS signal transmission stops, the DTR-8.2 remains in DTS mode and the DTS indicator remains lit. This prevents noise when you operate the pause or skip button on the player. Therefore, if the source is immediately switched from DTS to PCM, the PCM signal may not be played. In this case, stop the playback of the source on the player for about three seconds and then resume playback.

- You may not be able to play some DTS source signals from certain CD players and LD players even if you connect the player to the DTR-8.2 digitally. This is because the digital signal has been processed (such as the output level, sampling frequency, or frequency response) and the DTR-8.2 cannot recognize the signal as DTS data. Therefore you may hear noise when you play a DTS source while processing the signal.
- The outputs for the VIDEO 1 OUT, VIDEO 2 OUT, TAPE OUT, and ZONE 2 OUT, output analog audio signals. Do not record from CDs or LDs that support DTS using these outputs. If you do, the DTS-encoded signal will be recorded as noise.
- If a compact disc or LD encoded in the DTS format is played back with "PCM" selected, only noise will be produced. Always select "All" or "DTS" when playing back DTS-encoded sources.

2-2. Multichannel Setup sub-menu B

This setting is normally set to "No," and only needs to be changed to "Yes" if a DVD player, MPEG decoder, or other component that has a multi channel port is connected to the MULTI CHANNEL INPUT port for 5.1-channel, 6.1-channel, or 7.1-channel audio. For example, if a DVD player is connected to the MULTI CHANNEL INPUT port, then select DVD at the front panel as the input source, bring up this sub-menu, and select "Yes" for the Multichannel setting. You can only select Multichannel with the Audio Selector button when "Yes" is selected here.

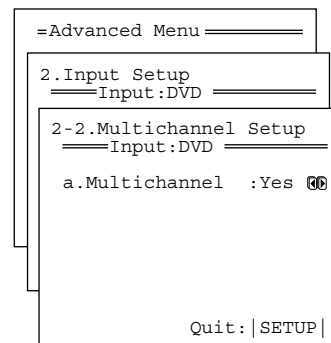

Multich Setup?

Input source selected	Multichannel
CD	No
PHONO	No
FM	No
AM	No
TAPE	No
DVD	Yes
VIDEO 1	No
VIDEO 2	No
VIDEO 3	No
VIDEO 4	No
VIDEO 5	No

Note:

When playing a device that is actually connected to the MULTI CHANNEL INPUT terminal, select Multichannel with the Audio Selector button.

Input Setup

2-3. Video Setup sub-menu B

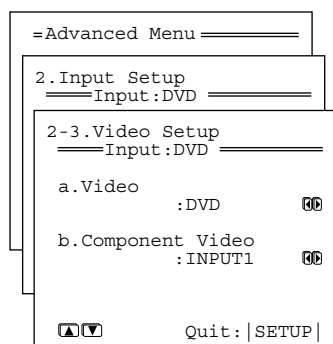

Video Setup?

a. Video

This setting allows you to match the audio from one component with the video from another. Therefore, you can set a video source to be displayed while the audio from another input source is heard. For example, this allows you to play the music from a compact disc, while displaying the picture from a video cassette player or other video source.

The default settings are given below.

Input source selected	Video
CD	Last Valid
PHONO	Last Valid
FM	Last Valid
AM	Last Valid
TAPE	Last Valid
DVD	DVD
VIDEO 1	VIDEO 1
VIDEO 2	VIDEO 2
VIDEO 3	VIDEO 3
VIDEO 4	VIDEO 4
VIDEO 5	VIDEO 5

Last Valid: When you change to an input source set to “Last Valid,” the video of the input source that you changed from is continued. For example, if the selected input source is VIDEO 1, and you then change to CD (set to “Last Valid”), then the audio from the CD input is played while the video from VIDEO 1 continues.

- If no video signal is to be assigned to the input source, set “--”

b. Component Video

If a component is connected to the one of the COMPONENT VIDEO inputs (1 or 2), then that input must be set here.

The default settings are given below.

Input source selected	Component video input
CD	Last Valid
PHONO	Last Valid
FM	Last Valid
AM	Last Valid
TAPE	Last Valid
DVD	INPUT 1
VIDEO 1	INPUT 2
VIDEO 2	INPUT 2
VIDEO 3	INPUT 2
VIDEO 4	INPUT 2
VIDEO 5	INPUT 2

Last Valid (enables the source last selected): The source that was selected last continues as the input source.

Input Setup

2-4. Character Input sub-menu B

This sub-menu allows you to give names to the stations you have preset for the AM/FM tuner, and to the input sources you have connected (excluding the tuner itself). Up to 10 characters can be entered for each name. For example, if you have a DVD connected to the VIDEO4 input jack, then you can give it the name "DVD2." Or, if you have multiple VCRs connected, you can enter the model names or manufacturer names for each one so that you do not have to remember which is connected to which input source.

If you want to enter a name for a preset broadcast radio station, select the station that you want to name and enter the name.

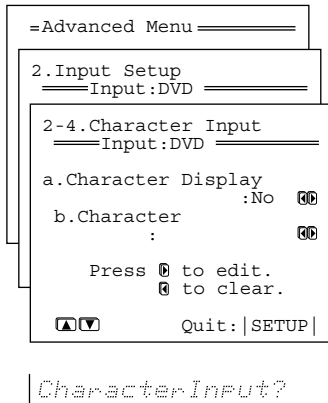

a. Character Display

Yes: Select to display the name you enter when the input source is selected.

No: Select to display the default name.

b. Character

If you have selected "Yes" for the Character Display above, then here you can enter the name that you want to display. Press ◀ cursor button to clear the current entry. Press ▶ cursor button to bring up the Character Input screen.

At the Character Input screen, press the cursor buttons to move the cursor to the desired character and then press the Enter button. That character will now appear in the 10-character space field above. Continue until the name is finished or until you have reached 10 characters.

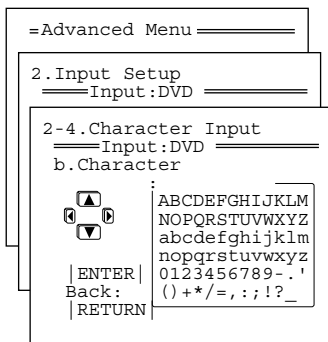

Using the cursor buttons, select the desired character and press the Enter button. To change a character, move the cursor backward with the Return button or forward with the Enter button to the location of mistaken character and enter the desired character. To erase a character, enter a blank space in its place. After completing the name, to exit, repeatedly press the Enter button. Continue until the name is finished or until you have reached 10 characters.

2-5. Intelli Volume sub-menu B

This sub-menu allows you to set some of the special features offered by the DTR-8.2.

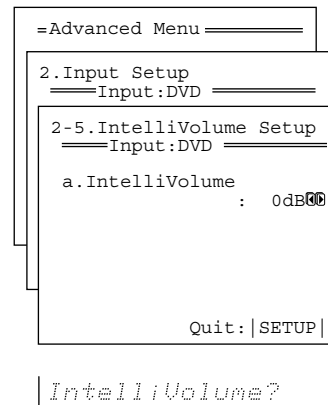

a. Intelli Volume

When switching input sources, you may find that the output level for different components or input sources connected to the DTR-8.2 is different even though the main volume setting is the same. Under normal circumstances, you would then have to change the volume setting each time you change the input source. This Intelli Volume setting allows you to preset a volume level for each input source separately so that when you do switch from one input source to another, the DTR-8.2 adjusts the volume accordingly so that the resulting volume stays the same. To set the Intelli Volume, simply select an input source at the front panel, and if that source is quieter than other sources, increase its decibel level with the ▶ cursor button, or if it is louder than other sources, decrease its decibel level with the ◀ cursor button.

The Intelli Volume can be adjusted between -12 and +12 decibels.

Input Setup

2-6. Listening Mode Preset sub-menu

With the DTR-8.2, you can set a different listening mode for each different signal type that comes from each input source. For example, if your DVD player also plays compact discs and the DVD video signal is Dolby Digital and the compact disc signal is PCM, then you can set a different listening mode for each.

This is especially convenient if you frequently play the same types of movies or music.

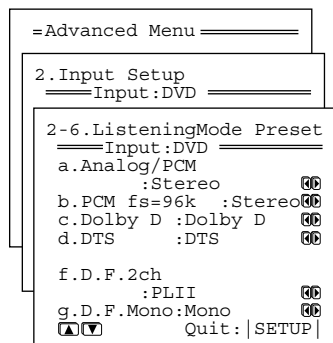

LstnModePreset?

* The 5.1-channel digital surround format has a variety of versions including Dolby Digital and DTS. The 5.1- channel digital surround format enables you to individually record and play five full-range (20 Hz to 20 kHz) channels (left and right front, center, and two surround channels) plus an LFE channel (Low Frequency Effect) for the low-range effect sound. It will create a realistic sound that can be heard in the theaters and concert halls.

Relationship between input source and listening mode

Input source signal (display)	Analog/PCM (2ch)	PCM fs=96kHz	Dolby D (Multi CH)	DTS (Multi CH)	D.F.2ch (Digital Audio Format)	D.F.Mono
Type of software	Tape, CD, MD, Record, Tuner, DVD (Stereo), LD, Digital satellite	DVD (96k/24bit)	DVD	DVD DTS-CD	DVD Digital satellite	DVD
Listening Mode						
Direct/Pure Audio	●	●				
Stereo	●	●	●	●	●	
Mono	●					●
Theater-Dimensional	●		●	●	●	
Dolby Pro Logic II	●	●			●	
Dolby Digital			●			
DTS Neo:6	●					
DTS				●		
DTS-ES Discrete				●		
DTS-ES Matrix				●		
THX Cinema(PLII)	●		●	●	●	
THX Cinema(Neo:6)	●					
THX Surround EX			●			
DTS-ES THX Cinema				●		
Mono Movie	●				●	●
Enhanced 7	●		●	●	●	
Orchestra	●		●	●	●	
Unplugged	●		●	●	●	
Studio-Mix	●		●	●	●	
TV Logic	●		●	●	●	
All Ch Stereo	●					

The listening modes that can be set are different for each input source format.

Note:

You may not be able to select all the listening modes shown here depending on your speaker configuration or the selected input source.

Input Setup

Input source signals

a. Analog/PCM

Analog sources consist of LP records, FM and AM broadcasts, cassette tapes, and the such. PCM (Pulse Code Modulation) is one form of digital audio signals and is recorded directly onto compact discs and DVDs without compression.

b. PCM fs=96k

Set a listening mode for the input signal from digital PCM sources recorded with a sampling rate of 96 kHz.

c. Dolby D (Dolby Digital)

Digital data with AC-3 compression and a maximum of 5.1-channel surround sound. This source signal comes from DVDs and LDs that have the  mark and therefore recorded for 5.1-channel output. This source also comes from digital satellite broadcasts that support Dolby Digital.

Dialog norm

Dialogue Normalization (Dialog Norm) is feature of Dolby Digital. When playing back software that has been encoded in Dolby Digital, sometimes you may see a brief message in the front panel display that read Dialog Norm xdB (“x” being a numeric value). Dialogue Normalization serves to let you know if the source material has been recorded at a higher or lower level than usual. For example, if you see the message “Dialog Norm: +4” in the front panel display, to keep the overall output level constant just turn down the volume control by 4dB. In other words, the source material that you are listening to has been recorded 4dB louder than usual. If you do not see a message, then no adjustment of the volume control is necessary.

Dialog Norm# +4

d. DTS

DTS (Digital Theater System) is compressed digital data with a maximum 5.1-channel surround output that allows for an extremely high-quality sound. This source signal requires a DVD player that supports DTS output and comes from DVDs, compact discs, and LDs that have the  mark.

f. D.F. 2 ch (Digital Format 2 channel)

2 channel digital signal (except for PCM) such as Dolby Digital. DVD or LD in which the 2 channel sound are recorded may be this type of input signal.

g. D.F. Mono (Digital Format Monaural)

Monaural digital signal (except for PCM) such as Dolby Digital. DVD or LD in which the monaural sound are recorded may be this type of input signal.

Listening Modes

Mono

This mode is for playing old movies whose sound is recorded in monaural or playing left and right channels separately in the movies which contains the different language signals recorded into individual channels. This mode also allows you to listen to the multiplexed soundtracks on DVDs, and other media that have them.

Direct/Pure Audio

This mode delivers pure sound with minimum sound quality adjustment and filtration. The sound recorded for the right and left front channels is output to the right and left front speakers only and not output to the subwoofer.

Same as the direct mode except that the pure audio mode also turns off the display window, turns off the power supply to the video circuitry, and minimizes the sources of noise. The result is high-fidelity music playback true to the original source.

Stereo

This mode has all input sound is output from the left and right front speakers.

Subwoofer also can be used for playback.

T-D (Theater-Dimensional)

For the best enjoyment of your home theater, it is recommended that you have at least front left and right speakers, a center speaker, and surround left and right speakers. However, if you only have front left and right speakers, you can enjoy multichannel audio by using this mode.

This mode controls the characteristics of the sound that reaches each ear to reproduce a multi-speaker setup. To receive the full effect, there is an optimum listening position (sweet spot). Refer to the explanation of the listening angle. In addition, if the reflective sound components are large, it may be difficult to achieve the desired result, so be sure to set up your system and listening position to minimize reflective sound.

DOLBY PRO LOGIC II

This mode is a new generation 5-channel surround system that provides performance between the 4-channel (left front, right front, center, and monaural surround) Pro Logic Surround and the 5.1-channel Dolby Digital Surround. This mode can be set to the Movie mode designed for playing movies and the Music mode designed for listening to music. In the Movie mode, the surround channels, which used to provide monaural output over only a narrow frequency range, now provide complete stereo output over the full frequency range. The result is movie viewing with a realistic feel of movement. The Music mode uses the surround channels to provide a natural sound space that cannot be provided with normal stereo output.

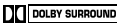
This mode can be used with VHS and DVD videos with the  mark and certain television programs. The Music mode can be used with music compact discs and other stereo sources.

If no surround speakers are connected, then the surround sound is divided and output from the front left and right channels (3 stereo).

Dolby D (Dolby Digital)

Used for playing Dolby Digital source.

Input Setup

DTS Neo:6

This mode is for 6.1 channel playback of 2 channel sources such as PCM or analog sources. All 6 channel outputs are wide frequency range with a great separation between the different channels.

This mode can be set to the Cinema mode designed for playing movies and the Music mode designed for listening to music.

The Cinema mode is good for movies. Reproduced surround sound makes realistic feel of movement as 6.1 channel sources. This mode can be used with VHS and television programs with stereo sound.

The Music mode uses the surround channels to provide a natural sound space that cannot be provided with normal stereo output. This mode can be used with music compact discs and other stereo sources.

DTS

Used for playing DTS source.

DTS-ES Discrete 6.1

With the addition of the surround back channel, this new format has all 6.1 channels recorded independently for a completely discrete digital format. Since all channels are recorded independently, high-fidelity surround playback with the increased feeling of a separated sound space is achieved.

DTS-ES Matrix 6.1

This format has the surround back channel matrix encoded and inserted into the left and right surround channels so that at playback the output for the left, right, and back surround channels are decoded using a high-precision matrix decoder.

THX

This mode is for playing back sources using THX.

For excellent fidelity when playing back THX sounds, it is recommended to use a THX-certified speaker system.

- **THX Cinema**

This is the conventional 5.1-channel THX format. This mode should be used only when playing back sources that were mixed for playback in large movie theater environments.

- **THX Surround EX**

“THX Surround EX - Dolby Digital Surround EX” is a joint development of Dolby Laboratories and the THX division of Lucasfilm Ltd.

In a movie theater, film soundtracks that have been encoded with Dolby Digital Surround EX technology are able to reproduce an extra channel which has been added during the mixing of the program. This channel, called Surround Back, places sounds behind the listener in addition to the currently available front left, front center, front right, surround right, surround left, and subwoofer channels.

This additional channel provides the opportunity for more detailed imaging behind the listener and brings more depth, spacious ambience, and sound localization than ever before.

When released to the home consumer market, movies that were created using the Dolby Digital Surround EX technology, may have a note to that effect on the packaging. A list of movies created using this technology can be found on the Dolby web site at <http://www.dolby.com> <<http://www.dolby.com>> .

This unit can play the 5.1 ch program in THX surround EX mode, even if the program is not encoded in Dolby Digital Surround EX format. For this kind of program, the sound from surround back channels depends on a program and may not fit to your taste.

Mono Movie

This mode is suitable for playing back monaural recording such as old movie soundtracks. The center channel delivers the unprocessed original sound, whereas the other channels deliver the center-channel sound processed with the appropriate reverberation. This allows you to enjoy monaural sound with the atmosphere of a movie theater.

Enhanced 7

Enhanced 7 intends to reproduce a natural surround environment by using 7-channel speakers. The sound effects moving smoothly toward the surround back. This mode is good for music and TV sports programs.

Orchestra

This mode is appropriate for classical and opera music. The center channel is cut and the surround channels are emphasized to widen the stereo image. It will simulate the natural reverberation that is created in large halls.

Unplugged

This mode is suitable for acoustical instrumental sounds, vocals, and jazz music. By emphasizing the front stereo image, it will simulate the acoustics that you would experience in front of the stage.

Studio-Mix

This mode is for rock and popular music. The lively sounds are enhanced for a powerful acoustic image that simulates the feeling of being in a club or rock concert.

TV Logic

This mode gives realistic acoustics to TV programs that are aired from TV studios. It enhances the entire surround sound and clarity of the conversation.

All Ch Stereo

This mode is designed for playing background music. The front, surround, and surround back channels create a stereo image that encompasses the entire area.

2-7. 12V Trigger Setup sub-menu

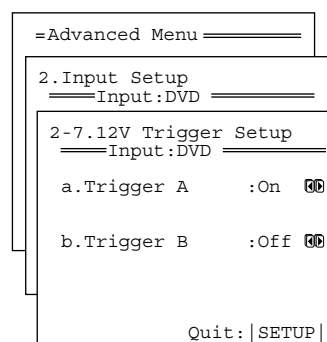

12V Trigger?

This sub-menu allows you to make the required settings to turn on the output from the 12V TRIGGER terminal to control another component or device with the DTR-8.2 for each input source.

a. Trigger A

On: Select to activate the device connected to the 12V TRIGGER A terminal when the input source is selected.

Off: Select when no device is connected to the 12V TRIGGER A terminal or you do not want the connected device to activate.

b. Trigger B

On: Select to activate the device connected to the 12V TRIGGER B terminal when the input source is selected.

Off: Select when no device is connected to the 12V TRIGGER B terminal or you do not want the connected device to activate.

Audio Adjust

3. Audio Adjust Setup menu

Set the various parameters for the sound signals.

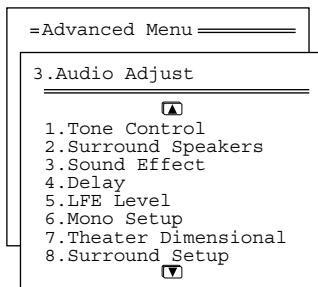

3.Audio Adjust

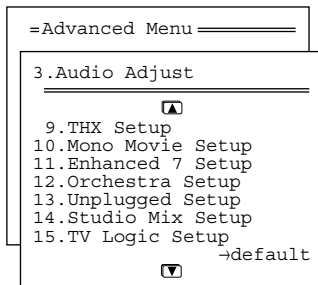

3.Audio Adjust

3-1. Tone Control **B**

Separately adjust the bass and treble settings as desired in 2-decibel units

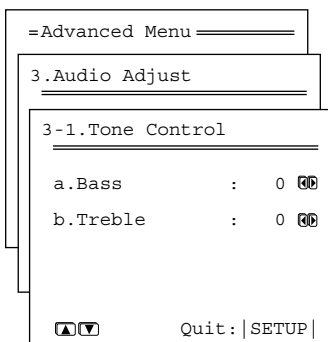

Tone Control?

Parameter	Setting	Initial value
a Bass	-12 to +12	0
b Treble	-12 to +12	0

3-2. Surround Speakers **B**

This setting allows you to decide which speakers to output to when surround back speakers are connected and you are playing back a 5.1-channel source.

Parameter	Setting	Initial value
a Surround Speakers	Surround L/R, Surround Back, Surr L/R + Back	Surround L/R

Surround L/R: This outputs the sound to the surround left and right speakers as normal and outputs nothing to the surround back speaker.

Surround Back: This outputs the sound to the surround back speakers and outputs nothing to the surround left and right speakers.

Sur L/R+Back: This outputs the sound to both the surround left and right speakers and the surround back speaker.

3-3. Sound Effect **B**

Turn on and off the various sound effects.

Parameter	Setting	Initial value
a RE-EQ	On, Off	Off
b Upsampling	On, Off	Off
c Subwoofer (Ana/PCM)	On, Off	On
d Late Night	Off, Low, High	Off

a) Re-EQ

Re-EQ (re-equalization) takes the edginess or “brightness” out of your home cinema sound to compensate for the fact that sound mixed for theaters may sound too bright when played back through speakers in the home environment.

This can be set to either “On” or “Off.”

This parameter is enabled for listening modes other than the THX listening mode.

b) Upsampling

Upsampling processes the input digital signal, or the digital signal converted from an analog input source, and converts its digital sampling frequency to twice its current frequency for an even further detailed sound reproduction. This can be set to either “On” or “Off.” When “On” is selected, the Upsampling indicator lights.

c) Subwoofer

When “Yes” is selected for the Subwoofer setting in the Speaker Config sub-menu, set this to “Off” if you do not want to have sound output from the subwoofer. This setting is only effective when the input source is Analog/PCM. If “No” is selected for the Subwoofer setting in the Speaker Config sub-menu, then this setting will not appear.

d) Late Night

Cinema sound has a vast dynamic range; therefore, to hear the quieter sounds such as human conversations, they must be played back at larger volumes. When this parameter is set to “High” or “Low,” the dynamic range of the sound is narrowed down to allow you to easily hear minute sounds at low volumes. This function is especially useful if you wish to play a movie at low volumes during the nighttime.

This can be set to either “Off” or “Low,” or “High.”

When this parameter is set to High or Low, the dynamic range of the sound is narrowed down to allow you to easily hear minute sounds at low volume.

Notes:

- The Late Night function is effective only on Dolby Digital encoded software.
- The depth of the Late Night effect is determined by Dolby Digital software. Some sounds may produce no or little effect.

Audio Adjust

3-4. Delay

This sub-menu gives you various ways to adjust the timing of the audio output from the speakers to give certain soundfield effects or to adjust for unwanted asynchronous video and audio tracks.

This sub-menu does not appear if "Direct" is selected as the listening mode.

	Parameter	Setting Initial value	
a	A/V Sync	0.0 ms to 74.0 ms	0.0 ms
Relative Delay			
b	Center	-4.0 ms to +6.0 ms	0.0 ms
c	Surr L/R	-4.0 ms to +6.0 ms	0.0 ms
d	Surr Back	-4.0 ms to +6.0 ms	0.0 ms

a. A/V Sync

If a digital signal processor is connected, there may be times when the audio and video from a DVD or LD player is not output in perfect sync. The result is where the sound and picture do not match and the sound is heard too early. In such a case, use this setting to properly synchronize the audio and video. This setting can be set between 0 to 74.0 ms in 0.5-ms increments. Under normal circumstances, this can be left at 0 ms. If set between 25.0 and 74.0 ms, upsampling is fixed to 24.0 ms. For input sources using the multi channel port, this setting will not appear.

Relative Delay

b. Center, c. Surr L/R, d. Surr Back

Besides level and delay adjustments, the DTR-8.2 provides the ability to change or adjust the relative speaker position to fine tune the soundfield for the listener. This is accomplished using Onkyo's unique Enhanced Spatial Positioning Algorithm. This adjustment provides 10 milliseconds of delay for the speakers, which is equivalent to moving the speaker 10 feet away. This adjustment is set up to provide -4.0 or +6.0 milliseconds (-4 or +6 feet) of adjustment to the listener's position.

Once the coarse adjustments--speaker level and distance adjustments--are made, the system is set up to provide a typical or broad surround environment. By adjusting the relative position of the speakers, we are able to alter the soundfield to be more spread out (deeper) or focused (shallower).

Note:

Surr Back will not appear if the Powered Zone 2 setting of the Speaker Config sub-menu is set to "Activated."

3-5. LFE Level Setup

This sub-menu is for setting the LFE (Low Frequency Effect) levels included in Dolby Digital and DTS software.

	Parameter	Setting Initial value	
a	Dolby Digital	$-\infty$, -10 dB to 0 dB	0 dB
b	DTS	$-\infty$, -10 dB to 0 dB	0 dB

a. Dolby Digital

The level can be adjusted to either $-\infty$ or between -10 to 0 decibels in 1-decibel increments. For Dolby Digital input source signals, the LFE level becomes that set here. A setting of 0 decibels is recommended for optimum performance; however, if the low frequency range is too strong, lower this setting as necessary.

b. DTS

The level can be adjusted to either $-\infty$ or between -10 to 0 decibels in 1-decibel increments. For DTS input source signals, the LFE level becomes that set here. A setting of 0 decibels is recommended for optimum performance; however, if the low frequency range is too strong, lower this setting as necessary.

3-6. Mono Setup

The settings shown below are enabled when the listening mode is set to "Mono."

	Parameter	Setting Initial value	
a	Academy	On, Off	Off
b	Input Channel	Auto L+R, Left, Right	Auto L+R

a) Academy

Older monaural film mixes relied on high-frequency rolloff in presentation to sound properly balanced, so that excessive hiss from the grain structure of the film would not be heard. The high-frequency loss was typically due to a combination of optical slit loss, electrical filters, loudspeaker response, and screen loss. Some films have been transferred to video without such a high-frequency rolloff, and thus sound overly bright and hissy. This unit includes this "Academy filter," which is based on contemporary playback practices for such films over wide-range systems.

This can be set to either "On" or "Off."

b) Input Channel

This allows you to set which input channel to use for monaural sound.

Auto L+R: Select this under normal circumstances.

When the input source is center channel only, this channel is used for monaural sound input channel. Otherwise, left and right channels are mixed and the mixed signal is used for monaural sound input channel.

Left/Right: You will need to select either left or right when playing a video source that contains bilingual data. In such a case, the left and right channels will contain different language. Select the channel with the language you desire.

3-7. Theater Dimensional Setup

Select this to modify the Theater-Dimensional (T-D) listening modes. The parameters that can be set are shown in the table below.

	Parameter	Setting Initial value	
a	Listening Angle	20 deg, 40 deg	20 deg
b	Center	On, Off	Off
c	Front Expander	On, Off	On
d	Virtual Surr Level	-3 dB to +3 dB	0 dB
e	Dialog Enhance	On, Off	Off

Theater Dimensional

For the best enjoyment of your home theater, it is recommended that you have at least front left and right speakers, a center speaker, and surround left and right speakers. However, if you only have front left and right speakers, you can enjoy multichannel audio by using this mode.

This mode controls the characteristics of the sound that reaches each ear to reproduce a multi-speaker setup. To receive the full effect, there is an optimum listening position (sweet spot). Refer to the explanation of the listening angle. In addition, if the reflective sound components are large, it may be difficult to achieve the desired result, so be sure to set up your system and listening position to minimize reflective sound.

Audio Adjust

a) Listening angle

The listening angle is the angle subtended by the front left and right speakers as seen from the listener. The setting of 20 and 40 degrees are only for nominal purposes, so select the setting that is closest to your actual listening angle.

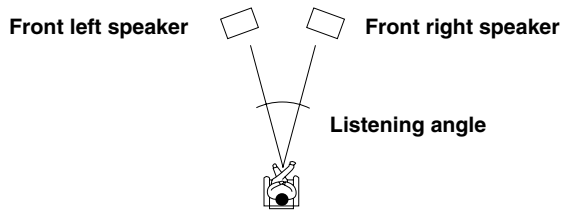

b) Center

For systems that have a center speaker, the center channel signal can be output from the center speaker. For instance, in systems where the front left and right speakers are small, use of the center speaker may provide a better sound space. (If your system uses a center speaker, be sure to perform the level calibration with the left and right speakers in the Speaker Setup menu beforehand.)

On: The center channel signal is output to the center speaker.

Off: The center channel signal is output from the front left and right speakers (Phantom Center).

c) Front Expander

The front expander function spreads out the sound from the front speakers for the feeling of a wide sound space.

On: Select to turn on the front expander function to simulate a wider sound space.

Off: Select to turn off the front expander function for a normal sound space.

d) Virtual Surr Level

This parameter adjusts the virtual surround level. This can be set from -3 to +3 decibels.

Lowering this setting can improve the sound when the definition is unclear or when the sound feels unnatural.

e) Dialog Enhance

This parameter allows you to adjust the dialog sound level from the center speaker if it is difficult to hear.

On: Enhances the vocal ranges for the center channel signal.

Off: Outputs the center channel signal at the regular level and frequency characteristics.

3-8. Surround Setup

Select this to modify the plain Dolby Digital, DTS, and Pro Logic II Surround listening modes. The parameters that can be set are shown in the table below.

	Parameter	Setting Initial value	
a	Surr Mode (Analog/PCM)	Pro Logic II Movie Pro Logic II Music DTS Neo:6 Cinema DTS Neo:6 Music	Pro Logic II Movie
b	Surr Mode (D.F.2ch)	Pro Logic II Movie Pro Logic II Music	Pro Logic II Movie
c	DTS-ES	Auto, On, Off	Auto
<Pro Logic II Music>			
d	Panorama	Off, On	Off
e	Dimension	0, 1, 2, 3, 4, 5, 6	3
f	Center Width	0, 1, 2, 3, 4, 5, 6, 7	3

a) Surr Mode (Analog/PCM)

Changes the surround mode for 2-channel analog/PCM input signals.

b) Surr Mode (D.F.2ch)

Changes the surround mode for 2-channel digital input signals.

c) DTS-ES

Selects DTS-ES mode.

Auto: When the DTS source has the DTS-ES flag (ID signal for DTS-ES), the listening mode is automatically changed to DTS-ES Discrete 6.1 or DTS-ES Matrix 6.1. If the DTS source has no DTS-ES flag, the mode is changed to DTS 5.1.

On: When the DTS source has the DTS-ES flag, the listening mode is automatically changed to DTS-ES Discrete 6.1 or DTS-ES Matrix 6.1. If the DTS source has no DTS-ES flag, the mode is forced to be DTS-ES Matrix 6.1.

Off: Even when the DTS source has the DTS-ES flag, the DTS-ES listening modes are not used. The DTS sources are always played in DTS 5.1 mode.

d) Pro Logic II Music Panorama

Use this listening mode to expand sound space in front of a listener to both side of the listener.

On: Turns on the PL II Music Panorama mode.

Off: Turns off the PL II Music Panorama mode.

e) Pro Logic II Music Dimension

Use this listening mode to modify the sound space location forward or backward.

The setting of "3" is the normal position and setting to "2" or lower moves the sound space forward and setting to "4" or higher move the sound space backward.

If the recording sounds too spread out or if the surround sound is too strong, move the sound space forward to get the appropriate sound balance. In contrast, if the stereo recording is somewhat felt like monaural or has narrowness, move the sound space backward to get more surroundness.

f) Pro Logic II Music Center Width

In Pro Logic II decoding, outstanding center signal will be output only from center speaker. When the center speaker is not used, the decoder divide the center signal equally to each front left and right speakers to create "phantom" center sound image.

The Pro Logic II Music Center Width mode allows you to adjust where the center sound image is heard from. Depending on your setting, the center sound image will be heard from center speaker only, front left and right speakers (as phantom center sound image), or all three speakers (center, front left and right) in various level combinations. For home use, applying some "width" to center signal will improve the level balance for center and main speakers, and effect the width of the center sound image, or "mass" of the sound. Many of sound recordings processed for stereo playback will be reproduced better by controlling the parameter for this listening mode. The recommended setting for Pro Logic II Music mode is "3." This allows you to easily distinguish the Pro Logic II Music mode from the Pro Logic II Movie mode whose setting is automatically set to "0."

Audio Adjust

3-9. THX Setup

Select this Setup THX listening modes; the one that is currently set is the one that is modified. The parameters that can be set are shown in the table below.

	Parameter	Setting	Initial value
a	RE-EQ (THX)	Off, On	On
b	Decoder (Analog/PCM)	PL II, Neo:6	PL II
c	THX Surround (Dolby D)	Off, On	Auto

a) Re-EQ

Re-EQ (re-equalization) takes the edginess or “brightness” out of your home cinema sound to compensate for the fact that sound mixed for theaters may sound too bright when played back through speakers in the home environment.

This can be set to either “On” or “Off”.

This parameter is only enabled for the THX listening mode. Also, this is set to “On” when the DTR-8.2 is turned on.

b) Decoder

Select the decoding mode for THX processes.

PL II: Select for Dolby Pro Logic II Movie.

Neo:6: Select for DTS Neo:6 Cinema.

c) THX Surround EX (Dolby D)

This setting allows you to set whether or not Dolby Digital sources will be played back using THX Surround EX when a surround back speaker is connected.

Auto: Automatically outputs signals with EX-identifying signals using THX Surround EX.

On: Outputs using THX Surround EX regardless of whether or not the signal contains EX identifiers.

Off: Does not output using THX Surround EX regardless of whether or not the signal contains EX identifiers (Dolby D is used).

Note:

THX Surround EX (Dolby D) will not appear if the Powered Zone 2 setting of the Speaker Config sub-menu is set to “Activated.”

3-10. 3-11. 3-12. 3-13. 3-14. 3-15.

Mono Movie Setup/Enhanced 7 Setup/Orchestra Setup/Unplugged Setup/Studio-Mix Setup/TV Logic Setup

When you set the parameters of this sub-menu and select Mono Movie, Enhanced 7, Orchestra, Unplugged, Studio-Mix, or TV Logic as the listening mode, the set parameters become enabled.

	Parameter	Setting	Initial value
a	Front Effect	Off, On	On
b	Reverb Level	Low, Middle, High	Middle
c	Rever Time	Short, Middle, Long	Middle

a) Front Effect

Some live recordings contain acoustic reverberation. When you play these sources, more reverberation will be applied by the DSP, creating too much reverb effects and the sound loses frame or presence. In this case, set this setting to “Off.” No reverberation from the DSP will be applied to the sound output from the three front channels, so the sound source is be played as it is without any further reverberation.

b) Reverb Level

This parameter allows you to adjust the depth of acoustic reverberation to match the playback source material, the acoustics of your room, and such other factors.

Select from the three settings “Low,” “Middle,” and “High.”

c) Reverb Time

Adjust the reverb time to match the source being played back and the acoustics of the room. Select from the three settings “Short,” “Middle,” and “Long.”

Relationship between listening mode and parameter

Parameter	Tone Control	Subwoofer	Re-EQ	Surround Speakers	Upsampling	LATE NIGHT	LFE Level	Front Effect	Reverb Level	Reverb Time
Listening mode										
Direct/Pure Audio										
Stereo	●	●	●		●					
Mono	●	●	●							
Theater-Dimensional	●	●								
Dolby Pro Logic II	●	●	● *1	●	●					
Dolby Digital	●	●	●	●		●	●			
DTS Neo:6	●	●	● *1							
DTS	●	●	●	●			●			
DTS-ES Discrete	●	●	●				●			
DTS-ES Matrix	●	●	●				●			
THX Cinema(PLII)		●	●	●						
THX Cinema(Neo:6)		●	●							
THX Surround EX		●	●				●			
DTS-ES THX Cinema		●	●				●			
Mono Movie	●	●	●	●				●	●	●
Enhanced 7	●	●	●					●	●	●
Orchestra	●	●	●	●				●	●	●
Unplugged	●	●	●	●				●	●	●
Studio-Mix	●	●	●	●				●	●	●
TV Logic	●	●	●	●				●	●	●
All CH Stereo	●	●	●							

The surround given here refers to basic surround modes and consists of Dolby Pro Logic II, Dolby Digital, DTS, etc.

*1 Enabled for Dolby Pro Logic II Movie and DTS Neo:6 Cinema input sources.

Preference

4. Preference menu

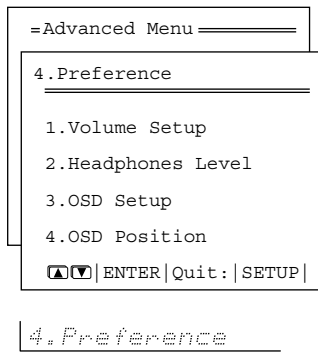

4-1. Volume Setup sub-menu

This sub-menu allows you to make various settings concerning the volume control of the DTR-8.2.

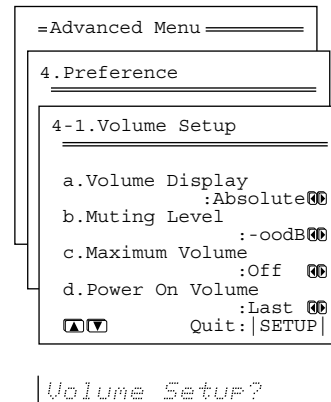

a. Volume Display

You can choose from two ways of displaying the volume setting on screen.

Absolute: This displays the volume with a minimum of min (0) for no sound and a maximum of max (100). As a reference, the volume setting of Ref (82) is used as the 0-decibel for the relative display method.

Relative: This displays the volume as a decibel value on a scale with a designated reference point that is displayed as 0, which equals the volume setting of 82 for the absolute display method. With this display method, the minimum value is $-\infty$, the next highest is -81 , and the maximum value is $+18$.

b. Muting Level

This sets the attenuation level during playback when the MUTE button is pressed on the remote controller. This can be set between $-\infty$, -50 and -10 decibels in 10-decibel increments.

c. Maximum Volume

This setting allows you to set the maximum volume that can be output with the MASTER VOLUME dial to prevent components from being damaged by excessively loud volumes. For the absolute volume display method, this can be set between 50 and 99. For the relative volume display method, this can be set between -32 and $+17$ decibels. To not set a maximum volume, select "Off."

d. Power On Volume

This sets a designated volume setting for the DTR-8.2 to be set every time that the power is turned on. This prevents the DTR-8.2 from being turned on while it is set to an extremely high volume and suddenly output very loud sounds. For the absolute volume display method, this can be set between min and max. For the relative volume display method, this can be set between $-\infty$ and $+18$ decibels. If you do not mind having the DTR-8.2 turned on with its current volume setting, set this to "Last."

Preference

4-2. Headphones Level Setup sub-menu

You can use this sub-menu to adjust the volume output from the headphones so that it matches the level output from the speakers. The headphone volume can be adjusted between -12 and +12 decibels.

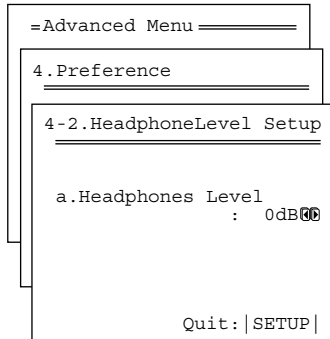

Headphones Lvl?

4-3. OSD Setup sub-menu

This sub-menu allows you to customize the OSD Setup menu to display in the manner you desire.

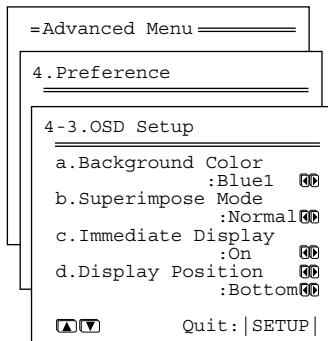

OSD Setup?

a. Background Color

Select either Blue1, Blue2, Green1, Green2, Magenta, Red1, or Red2 as the background color while the OSD Setup menu is displayed.

b. Superimpose

Off: Select to have the OSD Setup menu displayed on the selected background color.

Normal: Select to have the OSD Setup menu superimposed over the current video if one is displayed or on the selected background color if there is no video signal.

Black: Select to have the OSD Setup menu displayed on a black background at all times.

c. Immediate Display

On: Select this to have the screen immediately display certain operations as you perform them. The display will remain for a few seconds after the operation is completed.

Off: Select this to turn off the immediate display of operations.



Hint:

If this is set to "Off," the background color will not be displayed even when there is no video signal input.

d. Display Position

Use this setting to select the position of the immediate display that appears when certain operations are performed. You can position the immediate display at any of ten different levels ranging from the top all the way to the bottom.

4-4. OSD Position sub-menu

This sub-menu allows you to adjust the position of the OSD Setup menu as it is displayed on your screen. Depending on the monitor used, there may be cases where the OSD Setup menu is not displayed in the center and parts of the menus are cut off. To adjust the position of the OSD Setup menu, simply press the cursor buttons to inch the menu to position you desire.

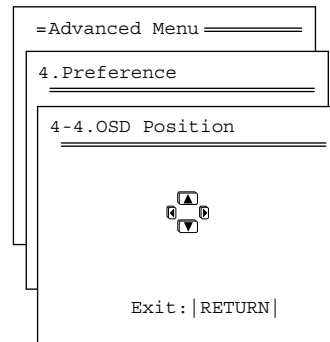

OSD Position?

Listening to Radio Broadcasts

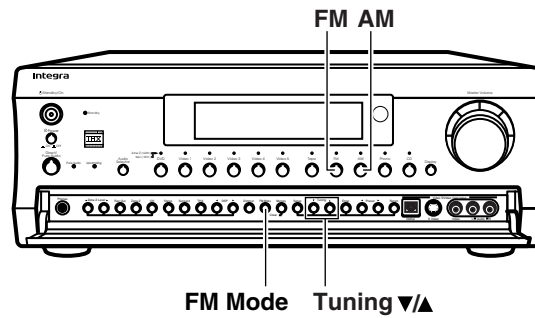

One of the features of the DTR-8.2 that is most frequently used is its ability to play FM and AM broadcast radio stations. The DTR-8.2 provides a number of listening modes perfect for listening to the radio and getting the most out of your audio system. Also, by presetting radio stations that you listen to frequently, you can select them easily by pressing the CH +/- buttons on the remote controller.

Listening to a stereo radio station (FM mode)

When you tune into a radio station, ► TUNED ◀ indicator appears in the display. If you tune into an FM station in stereo, then "FM STEREO" appears. If the signal is weak, it may be impossible to tune into the station in stereo. In such a case, **press the FM Mode button** on the front panel. The AUTO indication disappears and the radio station is output in the monaural mode. To return to stereo, press the FM Mode button again. "AUTO" appears. Some inter-station noise may be heard, but the sound will not cut in and out as it would if stereo was selected.



Tuning into a radio station

1. Press either the AM or FM input source button.

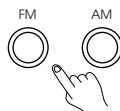

2. Using the Tuning ▲ and ▼ buttons on the front panel, tune into the station you desire.

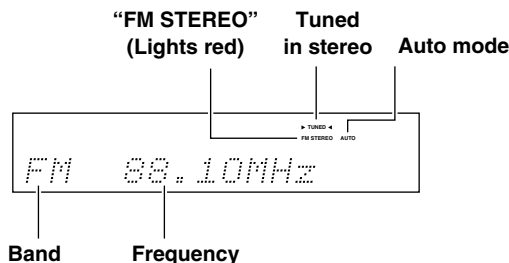
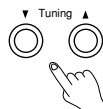

- The tuner frequency changes in 50 kHz increments for FM and 10 kHz increments for AM.
- When tuning into FM stations, you can press the Tuning ▲ or ▼ button continuously for more than 0.5 seconds to scan for an FM station in the direction of the button you pressed (FM auto tuning mode). After you release the button and a station is received in stereo, the scanning stops.

Listening to Radio Broadcasts

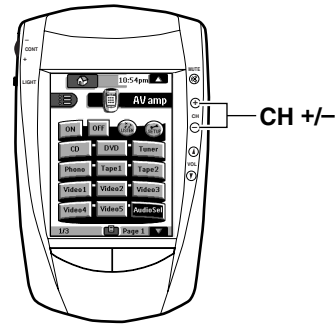
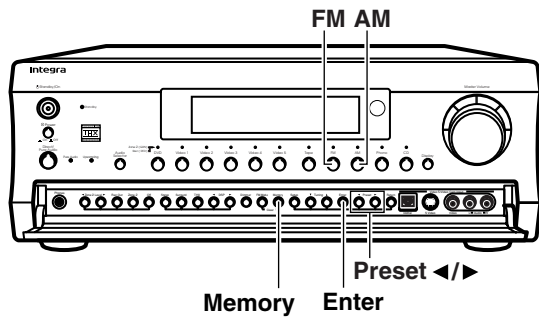

Presetting a radio station

1. Tune into the radio station you desire (see "Tuning into a radio station").

FM 88.10MHz

2. Press the Memory button on the front panel.

The MEMORY indicator lights red.

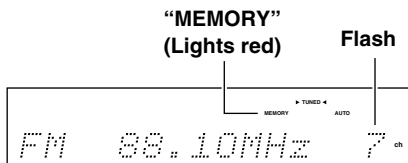

3. Using the Preset </> buttons, select a preset number (from 1 to 40) to assign the station to be preset.

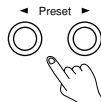

4. Press the Enter button to finalize the procedure.

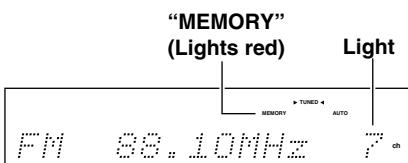

This programs the radio station as a preset radio station.

- Up to 40 stations can be stored in memory as preset radio stations.
- You can enter text names for any of the preset radio stations (see page 39).

Selecting a preset radio station

1. Press either the AM or FM input source button. The front display should show the currently selected frequency.

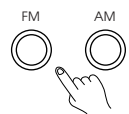

2. Press the Preset </> buttons and select the number of the desired preset station.

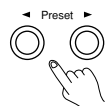

When using the remote controller:

1. Select AV Amp in the Home menu.
2. Press the CH +/- buttons and select the number of the desired preset station.

Erasing a preset radio station

1. Press the AM or FM button and press the Preset </> buttons to select the preset radio station that you want erase (see above).

FM 88.10MHz 7 ch

2. Press and hold the Memory button and then press the FM Mode button.

The selected preset station is erased.

Enjoying music or videos with the DTR-8.2

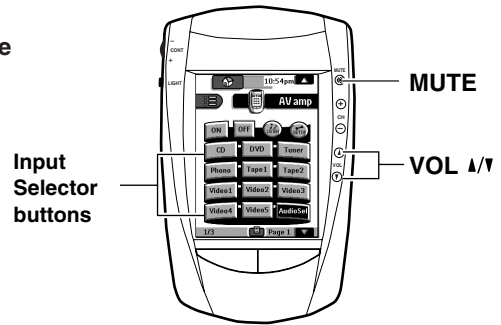
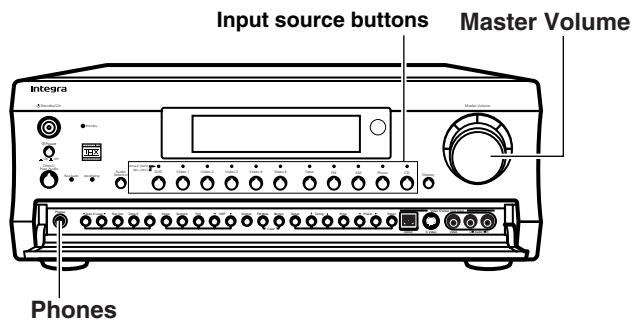

Though the DTR-8.2 is often used to listen to the radio, it does not show you its true ability until it is used to play music or watch videos, DVDs, and the like. The DTR-8.2 has the latest in state-of-the-art features to play back today's acoustic technologies with the utmost in fidelity and power. From a two-speaker system to a seven-speaker system, you are assured a sound space that you can always enjoy.

When using the remote controller, select AV Amp in the Home menu to display the operation menu.

Temporarily turning off the sound

To turn off the sound momentarily, such as when interrupted by a phone call, press the MUTE button on the remote controller. When pressed, "Muting" is displayed on the DTR-8.2. Press the MUTE button again to turn the sound back on.

Remote controller

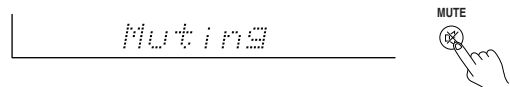

Basic operation

1. Press the input source (or input selector on the remote controller) button.

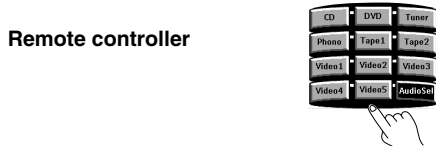
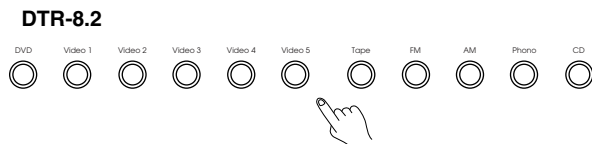

2. Turn on the corresponding component and play the media.

3. Adjust the volume.

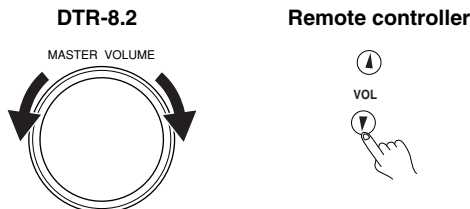

Adjusting the main volume adjusts the volume level output from all the speakers connected to the DTR-8.2 together. If headphones are connected, this also adjusts the volume heard from the headphone speakers. To adjust the volume, either press the VOL ▲/▼ buttons on the remote controller or turn the Master Volume dial. To increase the volume, turn the dial clockwise; to decrease the volume, turn the dial counterclockwise. The volume can be set to Min, 1 to 99, and Max (or $-\infty$, -81 to $+18$ dB)

Adjusting the bass and treble

You can adjust the bass and treble levels at the Setup menu: Audio Adjust → Tone Control. This function only affects the front left and right speakers, center speaker, and subwoofer. Only the bass level can be adjusted for the subwoofer (the treble adjustment is not effective). For multichannel sources, these dials will not work if the tone control is set to "Direct" or "Pure Audio."

Listening with headphones

To listen with headphones, plug a pair of headphones with a standard stereo plug into the PHONES jack on the DTR-8.2 front panel.

When you connect headphones, the unit will enter STEREO mode automatically and no sound will be heard from the speakers.

When the headphones are unplugged, the DTR-8.2 returns to its original listening mode.

When using the headphones, you can only use the Direct, Stereo, and Mono listening modes.

If you have selected MULTI CH INPUT, you will hear sound only from the FRONT L and R channels.

The headphone volume level can be adjusted at the Setup menu (see page 48).

Note that the signal to the remote zone (Zone 2) will not be affected whether or not headphones are connected.



Enjoying music or videos with the DTR-8.2

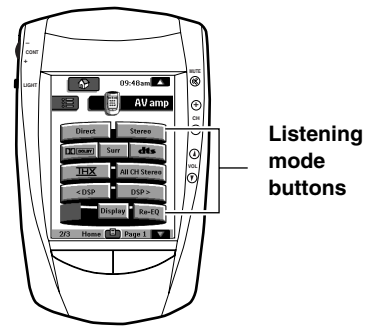
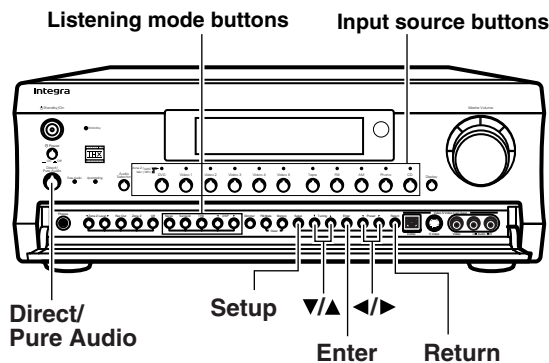

Changing the listening mode

To change the listening mode during playback, press the listening mode buttons.

When using the remote controller, select AV Amp in the Home menu to display the operation menu. Then tap the down scroll button to display the next operation menu.

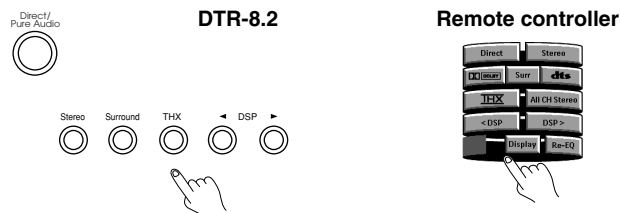

Direct/Pure Audio (Direct): Changes the listening mode directly to the Direct listening mode. If pressed, the listening mode for the selected input source set in the Listening Mode Preset is also changed to the Direct listening mode. When the listening mode is set to Direct, you can switch between Direct and Pure Audio.

Stereo (Stereo): Changes the listening mode directly to the Stereo listening mode. If pressed, the listening mode for the selected input source set in the Listening Mode Preset sub-menu is also changed to the Stereo listening mode.

Surround (Surr): Changes the listening mode to the surround mode for the current input signal (e.g., Dolby Pro Logic II, Dolby Digital, or DTS). If pressed, the listening mode for the selected input source set in the Listening Mode Preset is also changed to the Surround listening mode.

When the Surround listening mode is selected

- **When playing back DTS sources**
Switches the DTS-ES setting from Auto → On → Off.
- **When playing back Analog/PCM sources**
Switches from Pro Logic II Movie → Pro Logic II Music → DTS Neo6:Cinema → DTS Neo6:Music.
- **When playing back D.F. 2-channel sources**
Switches from Pro Logic II Movie → Pro Logic II Music.

(Remote controller only)

Dolby: When the input source is a digital source, this button works as the same for the Surround button. When the input source is Analog/PCM, this button changes the listening mode between Dolby Pro Logic II Movie and Dolby Pro Logic II Music.

dts: When the input source is a digital source, this button works as the same for the Surround button. When the input source is Analog/PCM, this button changes the listening mode between DTS Neo:6 Music and DTS Neo:6 Cinema.

THX: Changes the listening mode to the THX listening mode.

When the THX listening mode is selected

- **When playing back Dolby Digital sources**
Switches the THX Surround EX mode (Auto → On → Off) if the source is a Dolby Digital-compatible source.
- **When playing back Analog/PCM sources**
Switches the decoding mode (Pro Logic II Movie → DTS Neo6:Cinema) for THX processing.
- **When playing back DTS sources**
Allows you to enjoy the DTS THX Cinema, DTS-ES Discrete 6.1 THX Cinema, and DTS-ES Matrix 6.1 THX Cinema surround systems. The DTS-ES mode changes from Auto → On → Off.

If surround back speakers are not connected, or if the Powered Zone 2 setting of the Speaker Config menu is set to "Activated," you cannot select THX Surround EX, DTS-ES Discrete 6.1, or DTS-ES Matrix 6.1.

DSP \blacktriangleleft \blacktriangleright : Changes the listening mode as shown below.

Mono → Direct/Pure Audio → Stereo → Theater-Dimensional → Surround → THX → Mono Movie → Enhanced 7 → Orchestra → Unplugged → Studio-Mix → TV Logic → All Ch Stereo → Mono. If pressed, the listening mode for the selected input source set in the Listening Mode Preset is also changed.

Enjoying music or videos with the DTR-8.2

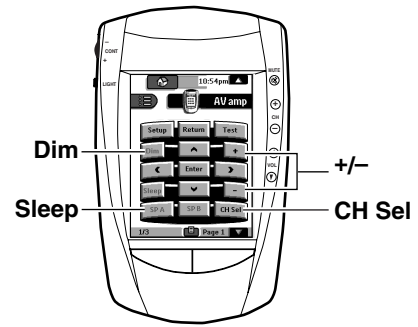
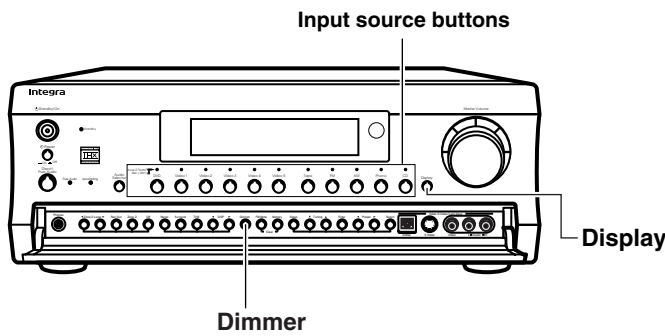

When using the remote controller, select AV Amp in the Home menu to display the operation menu. Then tap the down scroll button twice to display the third operation menu (Dim, Sleep, CH Sel, and +/-) or tap the down scroll button to display the next operation menu (Display).

Switching the display

While listening to or watching an input source, you can display the information regarding the type of source and signal being input by pressing the Display button on the DTR-8.2 or the remote controller.

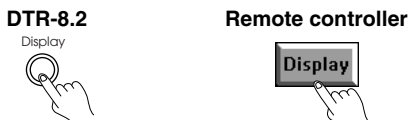

When an input source other than FM or AM is selected:

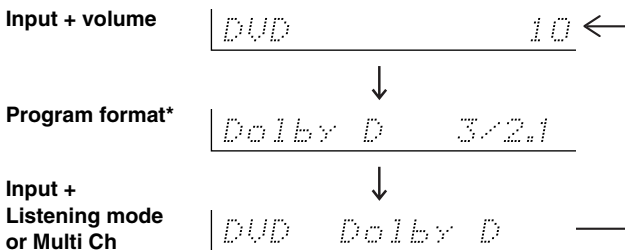

* If the input signal does not have a program format, then this will be skipped.

When FM or AM is selected as the input source:

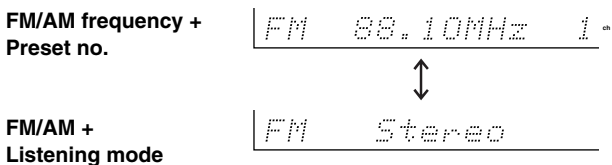

Adjusting the brightness of the front display

You can adjust the brightness of the front display of the DTR-8.2 with the Dim button on the remote controller or the Dimmer button on the DTR-8.2 front panel.

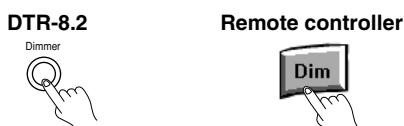

Using the sleep time (remote controller only)

The Sleep button enables you to set the DTR-8.2 to turn off automatically after a specified time period. If you press it once, the DTR-8.2 will turn off after 90 minutes. Each time it is pressed thereafter, the remaining time until the DTR-8.2 turns off decreases by 10 minutes. While, the sleep function is enabled, you can press the Sleep button to see how much time is left. To cancel the sleep function, press the Sleep button when the time displayed is less than 10 minutes.

If you are using the remote zone (Zone 2), it will turn off at the same time as the main zone. If you want to set the sleep function for Zone 2 only, set the sleep function with main zone turned on and then put the main zone into the standby state.

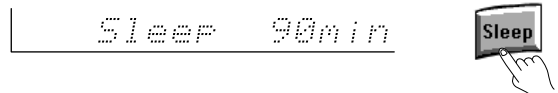

Temporarily changing the speaker output levels

To change the individual speaker volumes temporarily, follow the procedure given below. Each channel can be set between -12 to +12 decibels. Note that the calibration settings will return to the original settings when the DTR-8.2 is put in standby.

1. Press the CH Sel button and select the desired speaker.
2. Press the + or - button to adjust the volume level.

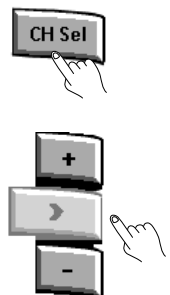

Notes:

- You cannot select a speaker if the Speaker Config sub-menu of the Speaker Setup is set to No or None.
- If the speaker level is set to +1 dB or higher, the maximum level indicated on the display will change if you raise the volume level.
- When you press the Test button after you set the level, the current level will be used as the value set via the test tone.

Enjoying music or videos with the DTR-8.2

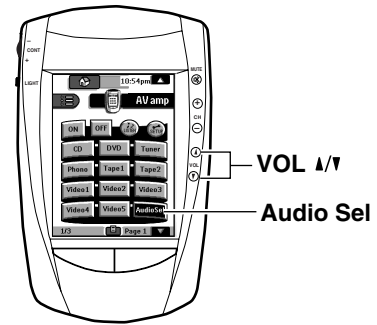
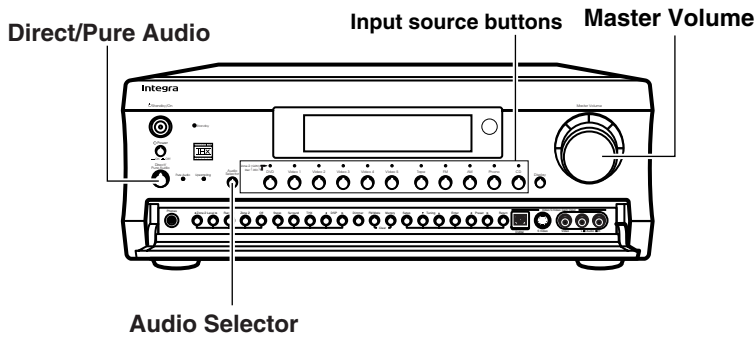

When using the remote controller, select AV Amp in the Home menu to display the operation menu.

Changing the audio mode

Press the Audio Selector button on the front panel (or Audio Sel button on the remote controller) to change the audio mode. Each time the button is pressed, the mode changes from “Auto” → “Multich” → “Analog” and back to “Auto.” The “Auto” audio mode is recommended for normal circumstances.

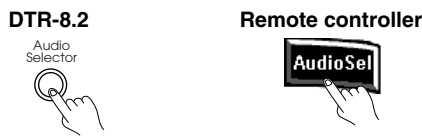

Auto (automatic detection): With this setting, the DTR-8.2 automatically detects whether the input signal is digital or analog. When a digital signal is not input, then the analog signal is played.

Multich (Multichannel): Select this setting to play back the input from the component connected to the MULTI CHANNEL INPUT port. This setting is effective when the Multichannel setting in the Multichannel sub-menu is set to “Yes” (see page 37).

Analog: Select this setting to play back the input from a source component connected to an analog audio input jacks. With this setting, even if a digital signal is input from the same component, only the analog signal will be output.

Enjoying the multichannel output

Before starting operations, first make sure that the multichannel connection is properly made and that the Multichannel setting of the Input Setup → Multichannel Setup sub-menu to “Yes.”

1. Press the input source button for the component with multichannel output connected to the MULTI CHANNEL INPUT on the rear of the DTR-8.2.

2. Select “Multich” using the Audio Selector button on the front panel (Audio Sel button on the remote controller).

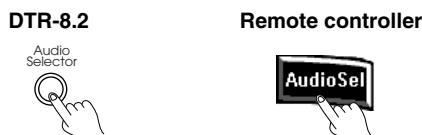

3. Turn on the connected component and start playing the desired media.

4. If necessary, adjust the output level of each speaker as desired (see page 55).

Adjust the speaker output levels so that you can hear the same sound level from each speaker at the listening position. For the front right, front left, center, surround right, and surround left speakers, the output levels can be adjusted between -12 to +12 decibels. The subwoofer can be adjusted between -30 to +12 decibels.

5. Adjust the volume with the Master Volume dial or the VOL ▲/▼ buttons on the remote controller.

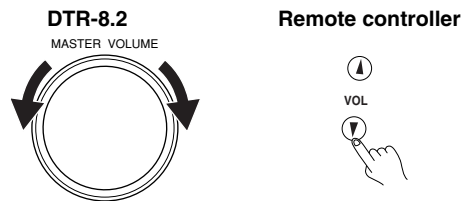

Using the tone control:

Each time you press the Direct/Pure Audio button (or Direct button on the remote controller), the display changes from “Direct”→“Pure Audio”→“Tone On.” To make bass and treble adjustment work for multichannel sources, you must first set the tone control to “Tone On.”

When using the remote controller, select AV Amp in the Home menu to display the operation menu. Then tap the down scroll button to display the next operation menu.

1. Press the Direct/Pure Audio button (or Direct button on the remote controller) to display “Tone On.”

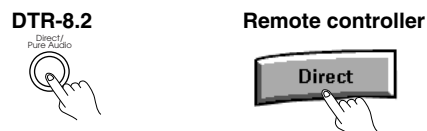

When pressed only once, the current setting appears, so press twice to change the setting.

2. Adjust the tone at the Setup menu: Audio Adjust → Tone Control.

Note:

Adjusting the volume level of each speaker for the MULTI CH INPUT source does not affect the speaker level adjusted by the listening position.

Enjoying music or videos with the DTR-8.2

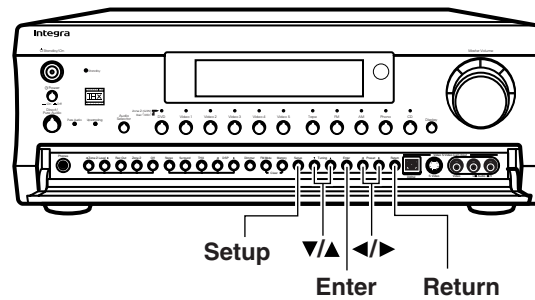

Entering names for input sources and tuner stations

You can enter names for your components or radio station names as names for your input sources and have them displayed in the front panel display when that input source is selected. (see page 39)

Entering characters using the DTR-8.2

1. Press the Setup button.
2. Press the ▼ button to select the “2.Input Setup” menu and press the Enter button.
3. Press the ▼ button to select the “Character Input?” sub-menu and press the Enter button.
4. Press the ▼ button to select “Char:” and press the ► button.
5. The screen changes to show you the characters you have already entered (< >) and then automatically changes to the Character Selection screen (ABCDEF...).

Press the ▲, ▼, ◀, and ▶ buttons to select the character you desire and press the Enter button. The screen again shows you the characters entered for approximately two seconds and returns you to the Character Selection screen.

If you enter an incorrect character, press the Return button to move the cursor to the left and re-enter the character.

Repeat the above operations to enter up to 10 characters. When you are finished, the entered name appears.

6. Press the Setup button to complete the procedure.

To correct entered characters

Perform steps 1 to 4 given above. After performing step 4, press the ► button to display a name that has already been entered. Press the Enter button to move the cursor to the location of the character that you want to change, enter the new character, and press the Enter button.

To delete an entered name

Perform the steps 1 to 3 given above. At step 4, press the ◀ button.

Enjoying music in the remote zone

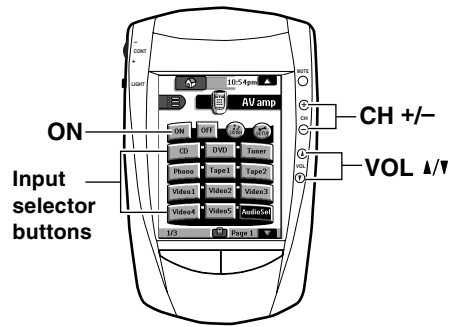
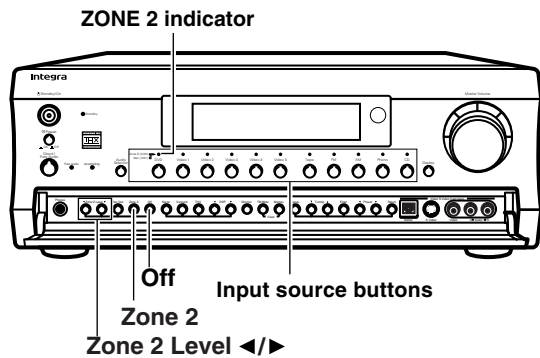

Playing music using the buttons on the DTR-8.2

1. Press the Zone 2 button on the DTR-8.2.

2. Select a source.

After pressing the Zone 2 button, you must press an input source button within 5 seconds. The Zone 2 indicator lights.

Ex.: When the CD button is pressed.

Zone2Sel:CD

To select the same source for the remote zone that is selected for the main zone, press the Zone 2 button again until "Zone2Sel:SOURCE" appears in the display.

Zone2Sel:SOURCE

When "Zone2Sel:Off" is displayed, the output to the remote zone is turned off.

Notes:

- If a sleep time is set with the Sleep button, it will also work for the remote zone.
- If the source for the main zone is selected as the source for the remote zone and the source for the main zone is changed, then the source for the remote zone will change as well.
- The Zone 2 terminal is an analog output. Digital signals are not output. If no sound is heard from the selected input source, check if the component is connected to the analog inputs.
- If the Rec Out button is pressed in the main room while someone is using the system in the remote zone, the Zone 2 function will be deactivated and the source will turn off in the remote zone.
- If you select FM (or AM) with the input source buttons when the source for the remote zone (Zone 2) is set to AM (or FM), the output for the remote zone also changes to AM (or FM).
- 7.1-channel playback in the main room is disabled if the Powered Zone 2 setting of the Speaker Config sub-menu is set to "Activated."
- When you are using the remote zone (Zone 2), RI system operation will not work.
- When you are using the remote zone (Zone 2), the Pure Audio setting will not work.
- When you are not using the remote zone (Zone 2), press the Zone 2 button and then press the Off button to turn off the Zone 2 indicator.

Selecting an input source using the remote controller

When using the remote controller, select Zone 2 in the Home menu to display the Zone 2 operation menu.

Turning on the Zone 2 and putting it in the standby state when the DTR-8.2 is in the standby state:

Tap the ON button.



Selecting an input source:

Press an input source button.

If you select Tuner of the input selector buttons, you can select a preset channel using the CH +/- buttons.

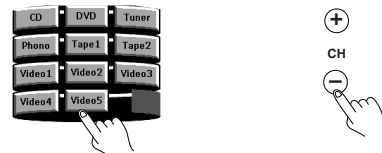

Note:

Each time you press one of the Zone 2 buttons on the remote controller, the STANDBY indicator on the DTR-8.2 flashes for five seconds. During this time, you will not be able to perform operations in the main zone using the remote controller.

Adjusting the volume for the remote zone

When the remote zone (Zone 2) speakers are connected to the SURR BACK/ZONE 2 SPEAKERS terminals, or to an amplifier connected to the SURR BACK/ZONE 2 PRE OUT terminals, adjust the volume as shown below.

Press the Zone 2 Level $\blacktriangleleft/\blacktriangleright$ buttons on the front panel.

Adjusting the volume:

Press the VOL $\blacktriangleup/\blacktriangledown$ buttons on the remote controller.

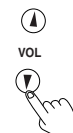

Note:

When the remote zone (Zone 2) speakers are connected to the pre-main amplifier that is connected to the ZONE 2 terminal of the DTR-8.2, adjust the volume for the remote zone at the pre-main amplifier.

Recording a source

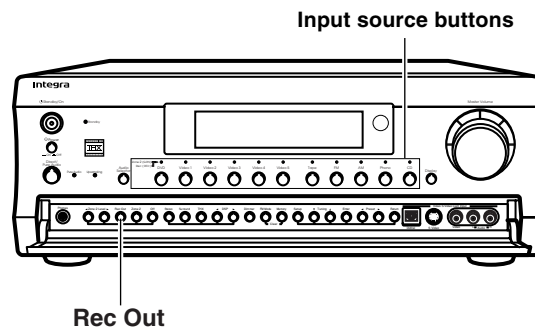

To record the input source signal you are currently watching or listening to

This method outputs to the audio and video outputs the currently selected input source signal. This method allows you to record a signal while you are actually listening to or watching it.

1. Select the input source to record by pressing the corresponding input source button.

The input source is now selected and you may watch or listen to it as desired.

2. Press the Rec Out button repeatedly until "Rec Sel:SOURCE" appears in the front display.

The currently selected input source signal to the TAPE OUT, VIDEO 1 OUT, VIDEO 2 OUT outputs for recording.

Rec Sel :SOURCE

3. Start recording at the recording component as desired.

To confirm the settings, press the Rec Out button. The current settings will appear for 3 seconds in the front display.

Notes:

- If you change the input source during recording, you will record the signals from the newly selected input source.
- You cannot record the surround effects.
- Digital signals input to the DIGITAL INPUT (COAXIAL) and DIGITAL INPUT (OPTICAL) inputs will be output to the DIGITAL OUTPUT (OPTICAL) output.
- Digital input signals are only output to the digital outputs and analog input signals are only output from the analog outputs. There is no conversion from digital to analog or vice versa. When connecting CD players and other digital components, do not connect only the digital terminals, but the analog ones as well.
- There are some restrictions on recording digital signals. When making digital recordings, consult the instruction manual that came with your digital recording equipment (e.g., MD recorder or DAT deck) to know what restrictions are imposed.
- You cannot record the source connected to the MULTI CHANNEL INPUT connector.

To record an input source signal different from that you are currently watching or listening to

This method outputs to the audio and video outputs the signal from the input source that you select here. This allows you to record an input source signal different from that which you are listening to or watching at the time of recording.

1. Press the Rec Out button.

2. Within 5 seconds, press the input source selector button of the input source signal that you wish to record.

The signal from the selected input source will now be output to the TAPE OUT, VIDEO 1 OUT, and VIDEO 2 OUT outputs for recording.

Rec Sel :VIDEO3

3. Start recording at the recording component as desired.

To confirm the settings, press the Rec Out button. The current settings will appear for 5 seconds in the front display.

Notes:

- Be aware that the remote (Zone 2) and recording (REC OUT) outputs use the same circuit and therefore can be used at the same time.
- You cannot record the surround effects.
- Digital signals input to the DIGITAL INPUT (COAXIAL) and DIGITAL INPUT (OPTICAL) inputs will be output to the DIGITAL OUTPUT (OPTICAL) outputs.
- There are some restrictions on recording digital signals. When making digital recordings, consult the instruction manual that came with your digital recording equipment (e.g., MD recorder or DAT deck) to know what restrictions are imposed.
- You cannot record the source connected to the MULTI CHANNEL INPUT connector.
- If you select FM (or AM) with the input source buttons when the recording source is set to AM (or FM), the output for the recording source also changes to AM (or FM).

Recording a source

Recording the video from one source and the audio from another

You can add the sound from one source to the video of another source to make your own video recordings.

Below is an example of recording the sound from a compact disc player connected to CD IN and the video from a video camera connected to VIDEO 5 IN to video cassette tape in a video cassette recorder connected to the VIDEO 1 OUT jack.

- 1. Press the CD input source button.**
- 2. Set “VIDEO 5” for the Video setting in the Video Setup sub-menu of the Setup menu: Input Setup → Video Setup → Video.**
- 3. Insert a CD in the CD player and insert a tape in the video camera connected to the VIDEO 5 IN.**
- 4. Insert a video tape for recording in the video cassette recorder connected to VIDEO 1 OUT.**
- 5. Press the Rec Out button repeatedly until “Rec Sel:SOURCE” appears in the front display.**

Now “CD” has been selected as the audio input source and “VIDEO 5” as the video input source.
- 6. Start recording on the video cassette recorder and start playing at the CD player and video camera as desired.**

Notes:

- If you change the input source during recording, you will record the audio signals from the newly selected input source and the video signals assigned to that input source.
- You cannot record the surround effects.

Quick Start

Insert batteries

Insert 4 AA batteries according to the picture on the inside of the battery compartment.

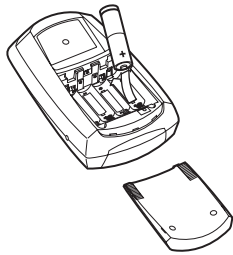

Battery compartment cover slides off

Touch the screen to start

To turn on the screen, tap it gently with your finger. To use the touchscreen, simply tap the images you see on the screen. There's no need to turn the screen off — it shuts off automatically to save power.



Be sure to read the manual for important information about care and use of the touchscreen.

Operate your components

Fresh out of the box, the remote controller is already set up to work with popular components made by Integra/Onkyo. Programming the remote controller is easy: Add components to the Device menu as necessary. Then, program the commands to the remote controller for the components. For instructions, refer to the manual.

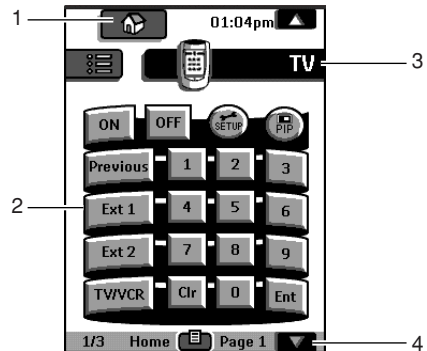

- 1. Home**
If you get lost, you can always go to the Home menu screen. Just tap Home.
- 2. Tap name of component to display component's control panels.**

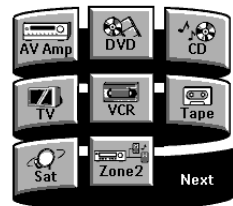

- 3. You can also use the Device menu; tap to display it.**
- 4. Tap to scroll to next panel for this component.**

Quick reference

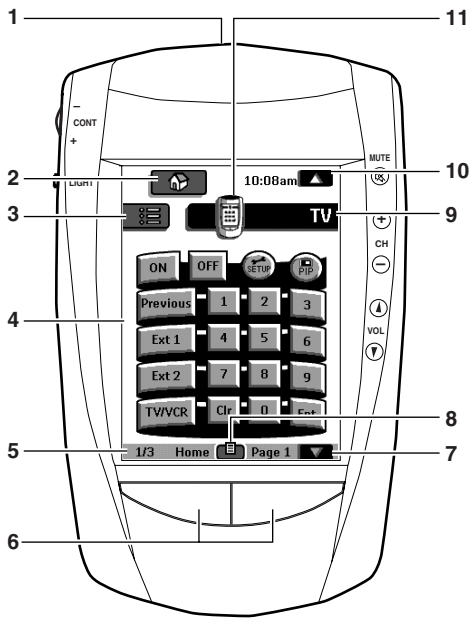

1. Sending eye (IR transmitter)/Learning eye

Send commands to devices.
For learning commands from other remote controllers.

2. Home

Easy access to all components.

3. Macro menu

Execute stored lists of commands.



4. Control panel

Tap buttons to send commands to components.

5. Panel number

Shows what panel you're seeing.

6. Left and Right buttons

Activate the commands shown immediately above the buttons.

7. Scroll button

Display next Control Panel. Scroll buttons may appear on left.

8. Mode menu

Customize the remote controller (see below).



9. Device menu

Open a component's control panels.

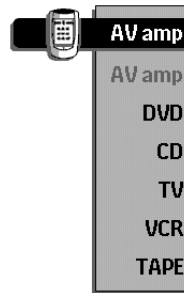

10. Scroll button

Display previous control panel.

11. Remote controller icon

Press and hold for 3 seconds to go to Setup.

Modes

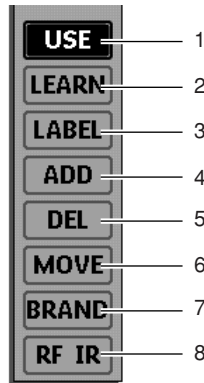

1. Normal use controlling components.

2. Learn commands from other remote controllers.

When a macro panel is displayed, this button changes to EDIT for recording macros.

3. Assign letters and symbols to buttons and commands.

4. Add a new component or group of macros.

5. Delete a button, component, macro, or macro group.

6. Change the order of commands in a menu.

7. Define the brands of your device.

8. Configure the remote controller to operate devices with RF or IR signals.

Introduction

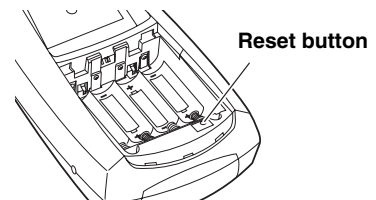
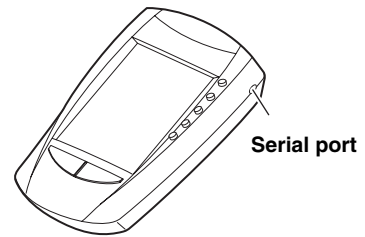
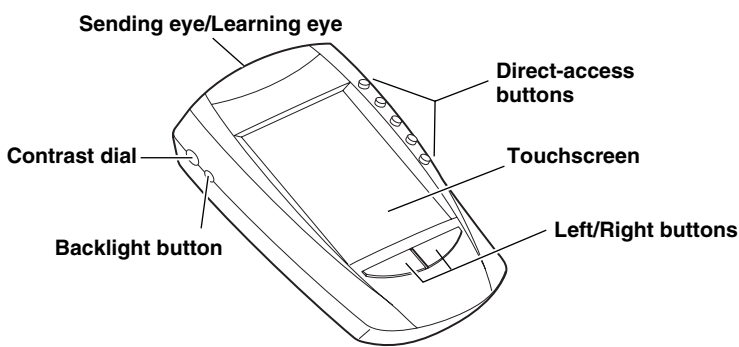

1. Intelligent Remote Controller

The intelligent remote controller can be used for all devices that understand infrared remote controller signals. Its easy-to-use touchscreen and its intuitive interface makes it a perfect remote controller for every user.

The remote controller is completely customizable and programmable. You can add devices and functions, relabel buttons, record macros and set timers. To make the remote controller your universal remote controller, it is designed to learn from existing remote controllers.

Direct-access buttons

The buttons labeled MUTE, CH, and VOL are direct-access buttons. The direct-access buttons make these frequently used functions available even when the touchscreen is off. You can program them so that they always operate the same components — for example, the TV. Or, you can program them to operate different devices at different times.

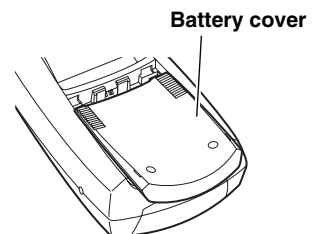

Introduction

Left and Right buttons

The Left and Right buttons change function depending on the device the remote controller is controlling. Labels displayed above them on the touchscreen show their current function.

Touchscreen buttons

Buttons on the touchscreen let you control particular devices. You activate the buttons by tapping them with your finger.

Which Buttons Can Be Programmed?

Direct-access buttons, Left and Right buttons, and buttons on the touchscreen can all be programmed. You can set the direct-access and Left/Right buttons to always perform the same function. Or, you can program them to perform different functions depending on the device. For instructions, see "Programming Buttons" on page 72.

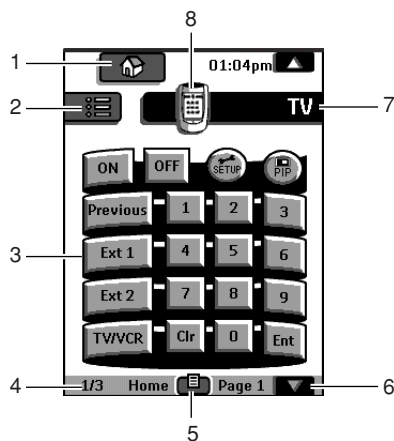

1. Home: to go to the Home menu

2. Macro menu: to open stored list of commands

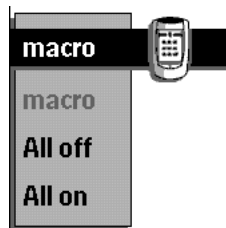

3. Control panel: to send commands to components

4. Panel number: shows active control panel

5. Mode menu: to customize the remote controller



6. Scroll buttons: to display previous and next control panel

7. Device menu: to open device control panels

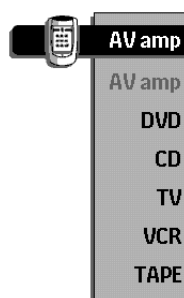

8. Remote controller icon: Touch and hold to enter Setup

Introduction

2. Charging the Remote Controller

AA batteries

1. Slide the battery cover off the back of the remote controller.

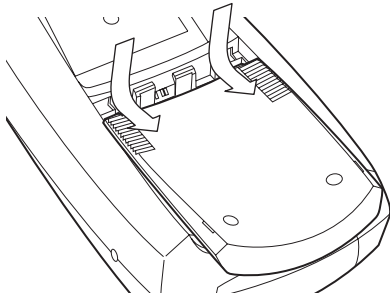

2. Insert 4 AA batteries (included in package) as indicated on the bottom of the battery compartment.

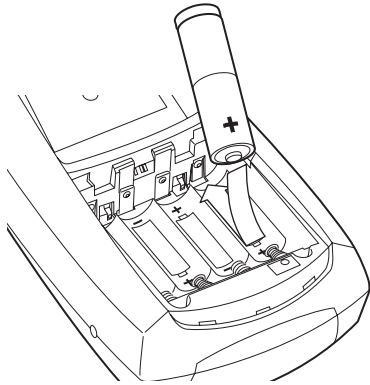

3. Slide the battery cover back on.

After a few seconds, the remote controller starts up automatically and beeps twice to indicate that it is ready to use.

When batteries are running low, the Low Battery icon  blinks at the center top of the display. Replace the batteries as soon as possible to ensure perfect performance.

Note:

The remote controller retains all settings when batteries have run out or when you replace them. You will only have to reset the clock.

Optional recharging dock

Warning:

Use the recharging dock only with the NiMH rechargeable battery pack of BCC-5.

1. Slide the battery cover off the back of the remote controller.
2. Remove the plastic AA battery tray from the battery compartment.

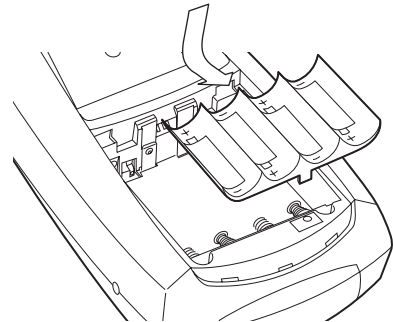

3. Insert the battery pack (included with the recharging dock) as indicated on the side of the battery pack.

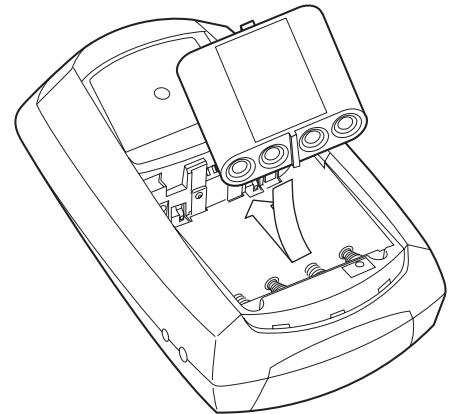

Introduction

4. Slide the battery cover back on.

After a few seconds, the remote controller starts up automatically and beeps twice to indicate that it has finished starting up.

5. Plug the power adapter into a wall outlet and connect it to the recharging dock.

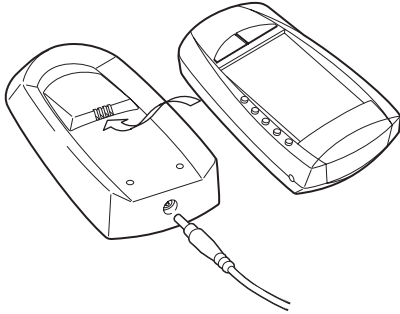

6. Place the remote controller on the recharging dock.

Recharging starts automatically. The light on the front of the recharging dock indicates charging takes place. When the battery pack is fully charged, the light goes off.

Notes:

- You can operate the remote controller while it is being charged.
- Normal charging time is 2 to 3 hours, depending on the condition of the battery pack.

When the battery pack is running low, the Low Battery icon  blinks at the center top of the display. Recharge the batteries as soon as possible to ensure perfect performance.

Note:

The remote controller retains all settings when the battery pack has run out. You will only have to reset the clock.

Getting Started

1. Activate the remote controller

Turning on the display

- **Tap the screen gently with your finger or a blunt, soft object like a pencil eraser.**

The display is activated and you see the Home panel.

Notes:

- If the display stays blank or becomes black, adjust the contrast dial on the left side.
- If another panel is displayed, tap the Home button.
- The remote controller shuts down automatically.

Using the backlight

- **Press the backlight button on the left side.**



The backlight shuts off automatically after a few seconds to save power.

Note:

In the settings (page 71) you can choose to activate the backlight automatically when you activate the remote controller.

Use mode

The remote controller has different “modes.” When you activate the remote controller for the first time, it starts up in Use mode allowing you to immediately operate your devices.

In Use mode, the remote controller icon  is entirely visible. If a label (like ) covers the icon, see page 72 to switch your remote controller to Use mode.

2. Define the Brand of Your Device

The remote controller uses RC codes to activate device. Since there are several brands using specific RC codes, you have to define the brands of your devices.

In the Home menu, you find buttons for the most common video and audio devices. The remote controller is set up by default to operate with Integra/Onkyo devices.

1. Select a device in the Home menu.

The following screen appears.

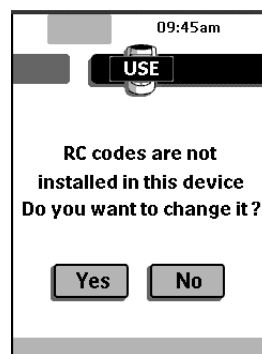

When selecting CD, DVD, MD or CDR

When you select CD, DVD, MD or CDR, the preset RC codes for operating Integra/Onkyo's CD player, DVD player, MD recorder or CD recorder are used, and the operation buttons for the device appear on the screen. You can use the preset RC codes only when the Integra/Onkyo's device you selected and Integra/Onkyo's amplifier or receiver are connected using **R1** interface.

When you operate Integra/Onkyo's CD player, DVD player, MD recorder or CD recorder which has no **R1 connectors or is not connected using **R1** interface, you need to define the brand of your device.**

1. In the Mode menu, select Brand.
2. Select the device you want to define.
3. Select Next.

The brand selection screen appears.

4. If you selected CD player, DVD player or CD recorder, select Onkyo or Onkyo-x other than Onkyo-1 from the brand list. If you selected MD player, select Onkyo-5.

To reset the RC codes settings back to the one for the device using **R1 connection, follow these steps.**

1. In the Mode menu, select Brand.
2. Select the device you want to reset the RC codes settings for.
3. Select Next.

The brand selection screen appears.

4. If you selected CD player, DVD player or CD recorder, select Onkyo-1 from the brand list. If you selected MD player, select Onkyo-4.

Getting Started

2. Select “Yes” to define the brand of the device to operate.

The remote controller switches to Brand mode. Follow the instructions as described below. You can define your brands by selecting or by searching.

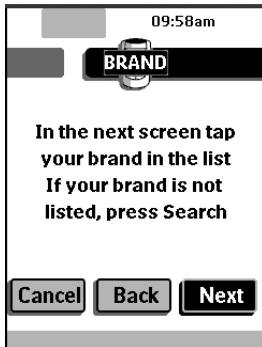

Note:
Before you start using the remote controller, make sure you define the brand for each device you want to operate in the Home Menu.

Defining brands by selecting

A list of brands and their corresponding RC codes are pre-installed in the remote controller's memory.

You need to select your brand from the list and because not every device of a certain brand uses the same RC codes, you might also have to select a set of RC codes for your brand.

3. Tap Next.

A scrollable list of brands for the selected device and a “virtual auto-zooming” mini-keyboard appears.

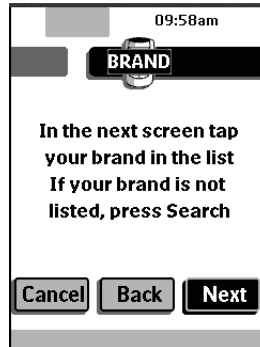

4. Navigate through the list of brands.

Use the scroll buttons to scroll up or down in the list of brands.

- By tapping the scroll buttons, you scroll through the brands one by one. By touching and holding the scroll buttons, the scrolling speed will increase.
- Use the mini-keyboard to jump through the list of brands. To enter a character, tap the keyboard near the character you want to use. The keyboard is zoomed in, allowing you to tap exactly the character you need.

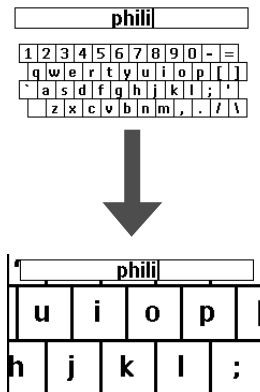

Getting Started

To enter a space, tap the lower left corner of the keyboard. When the keyboard is zoomed in, tap the empty key.

After you have typed the character, the keyboard is zoomed out. Repeat this action for every character.

Every time you enter a character, the list displays the brands that match the character(s). The remote controller makes a pre-selection of the (first) brand that matches. You only have to type as many characters as needed to display your brand.

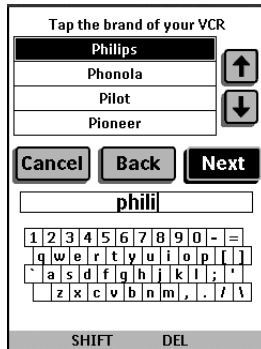

Note:

In case, your brand is not displayed in the list of brands, Try Search mode. See “Defining brands by searching” on page 68.

5. Select your brand from the list.

The selected brand will be highlighted. The Search button switches into Next.

6. Tap Next.

When your brand uses only one set of RC codes, the remote controller switches to Try mode. Go to step 9.

When there are several code sets for your brand, the following screen appears.

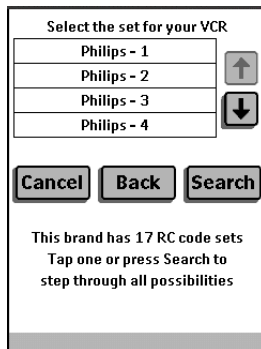

Notes:

- The code sets are ranked. The first code set in the list is used for most devices of the selected brand.
- When you do not know which code set to select from the list, you can use Search mode. See “Defining brands by searching” on page 68.

7. Select a code set from the list.

The selected code set will be highlighted. The Search button switches to Next.

8. Tap Next.

The remote controller switches to Try mode. The first control panel of the selected device is displayed.

9. Try the buttons on the different control panels and check if the device is responding to the RC codes the remote controller is sending.

Note:

However, your device is responding to the current code set, it is recommended to try other code sets. When your device responds to more than one code set, install the most suitable one.

10. If you are not satisfied with the way the device is responding to the selected code set, tap Back to select another code set.

or

When you are satisfied with the selected code set, tap Install.

When the RC codes for your devices are installed, the remote controller beeps and returns to Use mode. Your brand is now defined for the selected device.

11. Define all other devices in the Home menu you want to operate.

Getting Started

Defining brands by searching

You can use Search mode to find the matching RC codes for your device when

- your brand is not displayed in the list of brands,
- you selected your brand, but you do not know which code set to select.

3. Tap Next.

The display shows a scrollable list of brands for the selected device and a “virtual auto-zooming” mini-keyboard.

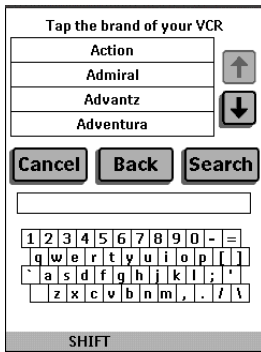

4. Tap Search

The remote controller automatically searches through all available brands and code sets to find the RC codes matches.

5. Tap Next to start sending appropriate commands for the selected device.



6. Tap OK when the device reacts.

Notes:

- Even when the device is responding to the current code set, it is advised to try other code sets. When your device responds to more than one code set, install the most suitable one.
- The name of the responding code set is displayed when you tap the OK button, so you know which code set to select from the list after you have tried other code sets.

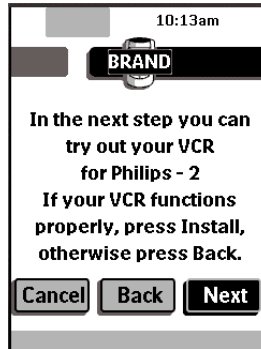

The remote controller switches to Try mode. The first control panel of selected device is displayed.

7. Try the buttons on the different control panels and check if the device is responding to the RC codes the remote controller is sending.

8. When you are not satisfied with the current function of the device, tap Back to continue the automatic search. or When you are satisfied with the selected code set, tap Install.

When the RC codes for your devices are installed, the remote controller beeps and returns to Use mode. Your brand is now defined for the selected device.

9. Define all other devices in the Home menu you want to operate.

Getting Started

3. Select a Device

Via the Home menu

In the Home menu, you find buttons for the most common video and audio devices. These buttons are preprogrammed to work with popular devices made by Integra/Onkyo. If you have devices of other manufacturers that do not respond to your remote controller, you can program your remote controller using your original remote controllers (see "Programming Buttons" on page 72).

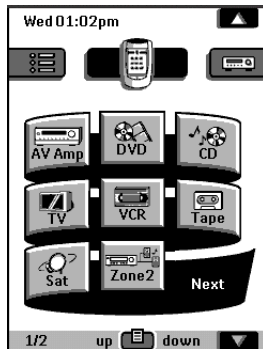

■ Tap the device you want to operate.

The first control panel of the selected device appears.

Via the Device menu

The Device menu allows you to easily switch to another device without returning to the Home menu.

1. From within any device control panel, tap the device tab.

The Device menu pops up. You can scroll through this menu using ▲ and ▼.

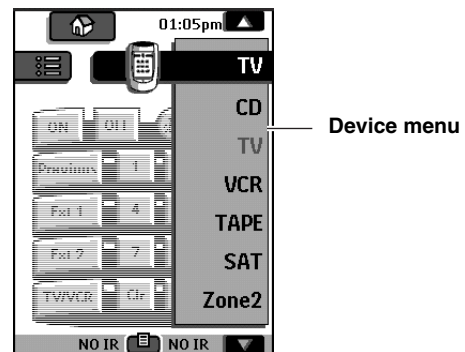

2. In the Device menu, tap the device you want to operate.

The control panel that was last accessed for the device appears.

Note:

You can also activate the Device menu from Home by tapping the device tab icon .

Getting Started

4. Operate a Device

You operate devices using three kinds of buttons:

- **Touchscreen buttons**
- **Left and Right button (below the touchscreen)**
- **Direct-access buttons (to the right of the touchscreen)**



Using touchscreen buttons

Sending commands

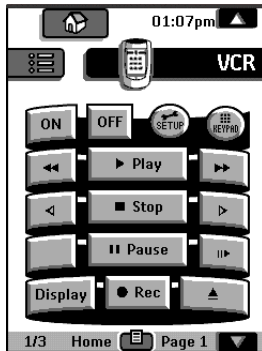
By touching the touchscreen buttons you send commands to the device you have selected. When you send a command, the remote controller icon shows transmitting signals . The name of the active device is indicated on the device tab.



Scrolling

Most devices have more than one control panel. You can scroll through these control panels using  and . The panel number on the left bottom of the screen indicates the panel number and the total number of panels, for example **1/3**.

By touching and holding a scroll button, you go repeatedly through all the control panels of a device in a loop.

Operating a device without affecting the active device

You can operate a device while another device is active (for example, rewinding your VCR while watching TV) via the Device menu:

1. **Open the device menu.**
2. **Press and hold the Left or Right button (labeled NO IR).**

The remote controller icon turns around .

3. **Tap the device you want to operate.**

The device control panel appears and the remote controller icon turns to its original position. You can now operate the new selected device without affecting the active device.

Using the Left and Right button

The Left and Right buttons change function depending on the device the remote controller is operating. The current function is displayed on the touchscreen right above the button. The function can be either an IR (infrared) command that is transmitted, or a jump to a specific device page.

IR commands



Device pages



Using the direct-access buttons

MUTE, CH and VOL can be operated at any time, even without turning on the touchscreen.

5. Adjust the Settings

Most of the remote controller's features can be set to your own needs.

1. **Touch and hold the remote controller icon for a few seconds.**

The first setup panel appears. You can see the second and third setup panel by using the scroll buttons.

2. **Tap the button of the setting you want to adjust.**

The button becomes black.

3. **Use the Left and Right button to adjust the setting.**

Note:

Tap the Left and Right buttons are repeating buttons; holding down one of these buttons will increase or decrease a value repeatedly.

Getting Started

First setup panel

Setting	Function	Adjusting
Battery	Shows the battery level.	
Clock	Turns the clock display on or off and lets you set 12 or 24h time display.	Tap the clock repeatedly.
Time	Sets the clock.	Tap the time button and use the Left and Right button.
Day	Sets the day.	Tap the day button and use the Left and Right button.
LCD	Sets how long the touchscreen stays on.	Tap the LCD button and use the Left and Right button.
LCD Light	Sets how long the backlight of the touchscreen stays on.	Tap the LCD Light button and use the Left and Right button.
Button Light	Sets how long the backlight of the direct-access and Left/Right buttons stays on.	Tap the Button Light button and use the Left and Right button.

Second setup panel

Setting	Function	Adjusting
Level	Turns the backlight always on or off when activating the touchscreen. Note: When you choose always off, you can only activate the backlight using the backlight button.	Always on: Tap the Level button and position the indicator in the right half of the indication bar using the Right button. Always off: Tap the Level button and position the indicator in the left half of the indication bar using the Left button.
Mode Menu	Hides or shows the Mode button. Hiding the Mode button prevents unwanted changes to stored commands.	Tap the Mode Menu button.
Touch	Adjusts or turns off the touchscreen beep.	Tap the Touch button repeatedly.
Button	Adjusts or turns off the beep of Left/Right and direct-access buttons.	Tap Button repeatedly.
Calibrate	Calibrates the touchscreen.	Tap the Calibrate button and follow the on-screen instructions.
Revert	Reverts the remote controller to the factory default configuration.	Tap the Revert button and follow the on-screen instructions.

Third setup panel

This panel provides technical information about your remote controller.

To exit Setup Mode

- Tap the Setup label on the remote controller icon.

Getting the Maximum out of it

1. Introduction

The remote controller is preprogrammed to work with all equipment that recognizes NEC infrared codes. This includes all Integra/Onkyo devices.

What makes the remote controller so powerful is the ability to extend its functionality in multiple ways like programming additional functions, adding supplementary devices, recording macros and customizing the interface as it suits you best.

Working with Modes

When you operate your devices, the remote controller is in Use mode. For actions other than operating (like programming buttons, recording macro's, adding devices, and so on) you have to switch to the appropriate mode:

- USE** : To operate devices.
- LEARN** : To input commands from other devices. For recording macros and setting timers.
- LABEL** : To label buttons and commands.
- ADD** : To add new devices.
- DEL** : To delete buttons, devices and macros.
- MOVE** : To change the listing order in a menu.
- BRAND** : To define brands using the remote controller's database.
- RF IR** : To configure the remote controller to operate devices with RF or IR signals.

To switch to another mode

1. Tap the Mode button at the bottom of the touchscreen.

The Mode menu pops up.

2. Tap the mode you want to use.

The label of the active mode appears on the remote controller icon. You can now work in the selected mode.

Note:

When a label is displayed, you can also display the Mode menu by tapping the label.

To hide the Mode menu

To prevent accidental changes to the remote controller interface and commands, you can hide the Mode menu:

1. Make sure the remote controller is in Use mode.

2. Touch and hold the remote controller icon for a few seconds.

The first setup panel appears.

3. Scroll down to the second setup panel.

4. Tap the Mode Menu button.

The mode menu icon is crossed out.

5. Tap **SETUP**.

The remote controller switches to Use mode. The Mode button is no longer visible.

2. Programming Buttons

You can program the remote controller commands by transmitting infrared signals from your existing remote controls to the remote controller's learning eye. To do this, place the remote controller and the device's remote controller on a flat surface, 15 to 20 cm (6 to 8 inches) apart.

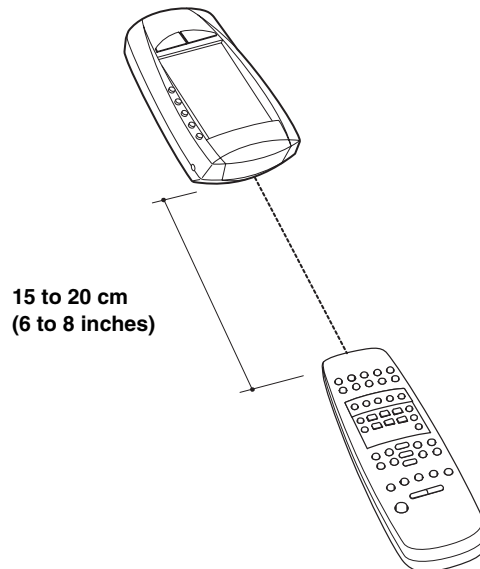

The following buttons can be programmed: control panel buttons, Device menu items, direct-access buttons and Left/Right buttons.

You cannot program Home menu buttons directly. You need to program them by following the Device menu (see page 73).

The remote controller also offers empty control panel buttons you can program and label as existing buttons. They are only visible in Learn and Label mode and appear without label or with label (intended for a specific function). You will also see previously deleted buttons: you can restore them by reprogramming them or you can reuse them for other commands.

Getting the Maximum out of it

Programming control panel buttons

- 1. Navigate to the control panel buttons you want to program.**
- 2. Switch to Learn mode by using the Mode button.**
Additional empty buttons appear: they can be programmed and labeled as existing buttons.
- 3. Point the device's original remote controller to the remote controller's learning eye as shown on page 72.**
- 4. Tap the remote controller button you want to program.**
The button starts blinking.
- 5. Press and hold the corresponding button on your device's original remote controller.**
If the remote controller has learned the command successfully, OK blinks on the remote controller icon. You can let go of the button you're holding.
If the remote controller has not learned the command successfully, you hear a short buzz and FAIL appears on the remote controller icon.
- 6. Program all other buttons you want and relabel them as necessary (see page 74).**
- 7. Return to Use mode by using the Mode button.**

Programming device items

Note:

When you program a command to a device item, this command is automatically assigned to the corresponding button in the Home menu.

- 1. Make sure the device tab is active.**
The device tab is active when the name of a device is displayed.
- 2. Switch to Learn mode by using the Mode button.**
- 3. Point the device's original remote controller to the remote controller's learning eye as described above.**
- 4. Tap the device tab to open the Device menu.**
- 5. Touch and hold either the remote controller's Left or Right button and tap the device you want to program.**
Even when you want to program the currently active device, you have to tap it in the Device menu.
The label device starts blinking on the remote controller icon.
- 6. Press and hold the button the remote controller has to learn on your device's original remote controller.**
If the remote controller has been input the command successfully, OK will blink on the display. You can release the button you're holding.
If the remote controller has not learned the command successfully, you hear a short buzz and FAIL appears on the remote controller icon.
- 7. Program all other items you want and return to Use mode via the Mode button.**

Programming direct-access and Left/Right Buttons

Direct-access and Left/Right buttons can be programmed with a global function or with functions per device. Buttons with global functions always execute the same command, even if device is active. Buttons with functions per device execute commands depending on the active device. For example, the Left button is the Play command when the VCR is active.

Note:

Per-device functions overrule global functions. For example, when you program the Volume buttons globally but you assign a specific function to them with the tuner, the specific command will be executed when the tuner is the active device.

Programming a button globally

- 1. Tap the Home menu button .**
- 2. Complete steps 2 to 7 in "Programming control panel buttons" (see above). Instead of tapping a button on the touchscreen, press the button you want to program.**
The label of the button you have pressed (e.g. chan+ or left) starts blinking on the remote controller icon.

Programming a button per device

- 1. Switch to the device for which you want to program the button.**
- 2. Complete instructions 2 to 7 in "Programming control panel buttons" (see above). Instead of tapping a button on the touchscreen, press the button you want to program.**
The label of the button you have pressed (e.g. chan+ or left) starts blinking on the remote controller icon.

Getting the Maximum out of it

3. Labeling Buttons and Menu Items

The following elements can be labeled: control panel buttons, Device menu items, macros, macro groups and Left/Right buttons.

You cannot label Home menu buttons directly. You have to label them by using the Device menu (see below)

Labeling a button

1. Navigate to the panel containing the button you want to label.
2. Switch to Label mode by using the Mode button .
3. Tap the button you want to label.

The display shows a “virtual auto-zooming” mini-keyboard. The button you want to label is displayed above the keyboard.

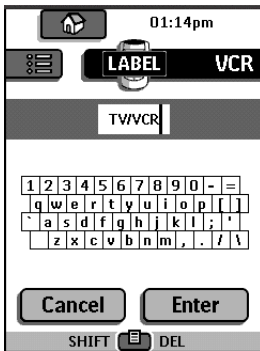

4. Edit the label.

- To delete a character, press the Right button.
- To enter a character, tap the keyboard near the character you want to use. The keyboard is zoomed in, allowing you to tap exactly the character you need.

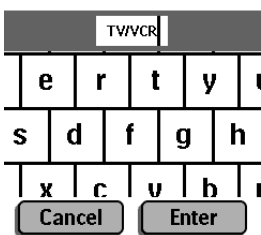
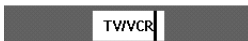

After you have tapped the character, the keyboard is zoomed out. Repeat this action for every character.

Note:

You can zoom out again without tapping a character by pressing the Right button (labeled Zoom).

- For capital letters and symbols, press the Left button repeatedly to display the keyboard you want.

5. Tap Enter to save the changes and return to the panel you were.

-or-

Tap Cancel to return to the panel you were without saving changes.

6. Label all other items you want and return to Use mode via the Mode button.

Labeling a menu item

1. Switch to Label mode by using the Mode button.
2. Tap the device tab to open the Device menu.
3. Touch and hold either the remote controller’s Left or Right button and tap the device you want to program.
Even when you want to program the currently active device, you have to tap it in the Device menu.
4. Complete instruction 4 to 6 in “Labeling a button” (see above).

Getting the Maximum out of it

4. Adding and Moving Devices

Adding devices

If you have a device that is not provided in the Device menu, you can add it to the remote controller.

You cannot add devices to the Home menu directly. You have to add them by using the Device menu.

1. Make sure the device tab is active.

The device tab is active when the name of a device is displayed.

2. Switch to add mode by using the Mode button.

The remote controller displays the following choices:

- **Create New Device:** Choose this option to add a completely new device.
- **Copy Existing Device:** Choose this option to copy a device already provided in the Device menu (for example for a second television).
- **Restore Deleted Device:** Use this option to restore a device you have deleted.

3. Tap the device you want to add in the Device menu.

Note:

If the device you want to add is not provided, choose a similar one. You can customize it later.

The remote controller gives you the possibility to add the device with or without RC-codes.

- **Creat with RC-codes:** Choose this option if you wan to copy the preprogrammed RC codes as well. The new device is added with operational buttons.
- **Don't add RC codes:** If you choose this option, the new device is added without operational buttons. You can program them as described in "Programming control panel buttons" on page 73.

4. Tap the button of your choice.

The new device is automatically displayed in Use mode.

Moving menu items

You can change the order of Device menu items and Macro menu items. Changes you make in the Device menu are automatically updated in the Home menu.

1. Make sure the device tab is active.

or

Make sure the macro tab is active.

The device or macro tab is active when the name of a device or macro is displayed.

2. Switch to Move mode by using the Mode button.

The remote controller displays the menu.

3. Tap the menu item of your choice.

The menu item is highlighted.

4. Use the Left and Right button to move the menu item up or down.

5. Tap Accept to save the changes.

You return to Use mode.

Getting the Maximum out of it

5. Delete and restore

Delete

You can delete control panel buttons and functions associated with a direct-access or a Left/Right button.

You can also delete Device menu items and Macro menu items.

Home menu buttons cannot be deleted directly. You have to delete them via the Device menu.

Deleting a button or button function

Note:

Buttons without bold frame can not be deleted. You can only hide them by removing their label (see “Labeling a button” on page 74).

START

1. Switch to Delete mode by using the Mode button.

2. Tap the button you want to delete.

3. Tap Delete Button Action.

The result depends on the element you are deleting:

- Control panel button: The button disappears from the display.
- Left or Right button command: The corresponding label disappears from the display.
- Direct-access button: The button becomes inactive.

4. Delete all the items you want and return to Use mode via the Mode button.

Deleting a device or macro menu item

1. Switch to Delete mode via the Mode button.

2. Navigate to the menu item you want to delete.

When Device menu is opening, The function of Left and Right button changes as shown below.

Left button: Label

Right button: Action

When Macro menu is opening, The function of Left and Right buttons will be Group.

3. Press and hold down the Left or Right button depending on what you are deleting:

- Left button labeled Device: For deleting a device in the Device menu.
- Right button labeled Action: For deleting an action from an item in the Device menu.
- Left button labeled Group: For deleting a macro group.

4. Tap the menu item you want to delete.

5. Tap Delete Device or Delete Macro Group.

The Device (and its associated Home menu button) or the Macro Group (including its macros) are deleted.

6. Delete all the items you want and return to Use mode via the Mode button.

Restore

After you deleted a control panel button or a menu item, the button or item is no longer visible in Use mode but remains in the remote controller’s memory. This allows you to restore it in Edit mode.

Actions associated with direct-access or a Left/Right buttons cannot be restored. You have to reprogram them as explained in “Programming Direct-access and Left/Right Buttons” on page 73.

Control panel buttons

1. Switch to Edit mode by using the Mode button.

The deleted buttons become visible.

2. Complete instruction 3 to 7 in “Programming control panel buttons” on page 73.

The button is restored.

Device or Macro menu items

1. Make sure the device tab or macro tab is active.

The device or macro tab is active while the name of a device or macro is displayed.

2. Switch to Add mode by using the Mode button.

3. Tap Restore Deleted Device or Restore Deleted Group.

The deleted menu items become visible.

4. Tap the item you want to restore.

The item is restored and you return to Use mode.

Note:

Only the macro group itself is restored, not the macros it contained.

Getting the Maximum out of it

6. Recording Macros and Setting Timers

A macro enables you to send a sequence of IR commands using one single button.

By setting a time, you can activate a device at the time you prefer. See page 78.

Note:

To record a macro or to set a timer, there must be at least one macro group or timer group in the Macro menu. To create these groups, see page 78.

Recording macros

1. Tap the Macro menu button.
2. Open the macro menu and select a macro group.



3. Switch to Edit mode via the Mode button.
Empty the macro buttons that appear in the macro control panel.
4. Tap the button you want to use for your macro.
5. Enter the sequence of commands you want to record.
You can navigate to any control panel you want, just as you can in Use mode.
6. Tap the Macro menu button.
The contents of the macro appear. You can now play, edit, or close the macro.
7. Press the Left button to close the macro.
A confirmation screen appears where you can save or cancel the macro.
8. Tap Save and assign a label to the macro.
The macro is ready to be used.

There are two extra commands you can record in a macro:

Source switching

To record a Device menu item containing a source switching command, open the Device menu, hold down the Right button (labeled Action) and tap the device you want to switch to.

Close a device control panel

To close a macro display of device, open the Device menu, hold down the Left button (labeled Device) and tap the device you want.

Editing macros

You can edit any macro you have recorded.

1. Open the macro group that contains the macro.
2. Switch to Edit mode via the Mode button.
3. Tap the macro you want to edit.

The contents of the macro appear.



4. Edit the macro.
You can move or delete listed commands or you can add new commands. You can also add delays to the macro (for example, to insert a short pause between turning on a device and sending commands to it allowing the device to warm up):
 1. Tap Delay.
 2. Tap + or - to decrease or increase the length of the delay.
 3. Use the arrow buttons ↑ and ↓ to move the delay to the right place.
5. Press the Left button to close the macro.
A confirmation screen appears, which allows you to save or cancel the macro.
6. Tap Save.
The macro is ready to be used.

Getting the Maximum out of it

Setting timers

To activate a device at the time you set.

1. Tap the Macro menu button.
2. Open the macro menu and select a timer group.
3. Switch to Edit mode by using the Mode button.

Empty timer buttons appear in the timer control panel.

4. Tap the button you want to set a timer for.

The first timer control panel appears in which you can set the start time.

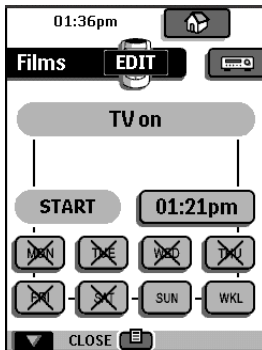

5. Enter the command the timer has to execute.

A timer can contain either a single IR command or a macro.

You can navigate to any control panel you want, just as you can in Use mode.

6. Tap the clock button and set the start time using the Left/Right buttons.

7. Tap one or more day buttons to select or deselect days for the timer.

You can choose to repeat the timer weekly.

8. Scroll down to display the second timer control panel in which you can set the stop time.

9. Enter the command the timer has to execute.

10. Tap the clock button and set the stop time using the Left/Right buttons.

11. Press the Left button to close the timer.

A confirmation screen appears, which allows you to save or cancel the timer.

12. Tap Save.

The timer is activated.

Note:

The timer only works when the remote controller's sending eye is pointed towards the controlled device and no obstructions interfere the infrared signal.

Editing timers

You can edit any timer you have set.

1. Open the timer group that contains the timer.

2. Switch to Edit mode via the Mode button.

3. Tap the timer you want to edit.

The contents of the timer appear.

4. Edit the timer.

5. Press the Left button to close the timer.

A confirmation screen appears, which allows you to save or cancel the timer.

6. Tap Save.

The timer is edited.

Organizing macros and timers into groups

You can create as macro groups or timer groups up to 25 macros or timers in each group.

1. Open any macro or timer group.

2. Switch to Add mode by using the Mode button.

You can create a new group, copy an existing group, or restore a previous deleted group.

- Create a new group: You add a new group in which you can record new macros.
- Copy an existing group: You copy a group and its macros and use it for new macros.
- Restore a previously deleted group: You restore a deleted group and reuse the macros.

3. Tap Create Timer Group or Create Macro Group.

Getting the Maximum out of it

7. Using the remote controller with Radio Frequency

Warning:

To use the remote controller with radio frequency (RF), you need an RF Receiver, which is not included in package.

By default, the remote controller uses infrared (IR) signals to operate devices. This means that you have to point the remote controller's sending eye towards the device you are operating. IR signals have an operating distance of 10 meters (33 feet).

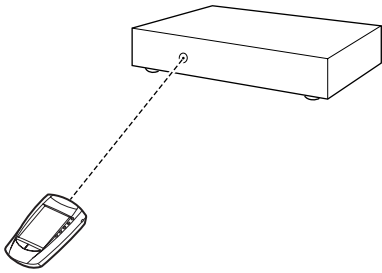

You can select to operate devices using radio frequency (RF) signals instead of IR signals. RF signals have an operating distance of approximately 20 meters (66 feet) in house and, unlike IR signals, is able to go through obstacles like furniture or walls. The RF signals sent out by the remote controller are picked up by the RF Receiver. The RF Receiver translates the RF signals in IR signals and sends the IR signals to the appropriate device.

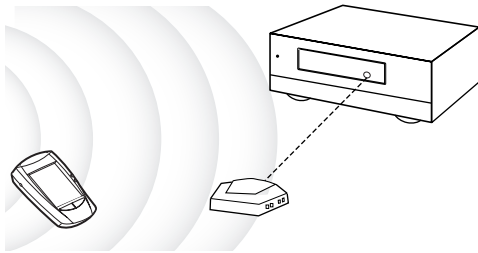

Therefore, the RF Receiver has to be placed near the device you're operating with the RF Receiver's sending eye pointed to the device. Your devices will always receive IR signals either directly from the remote controller or from the RF Receiver.

Changing the remote controller's RF IR Settings

All devices are set up by default to work with IR signals. To be able to operate one or more devices with RF signals, you have to change the remote controller's RF IR settings for those devices.

1. Make sure the Device tab is active.

The Device tab is active when the name of a device is displayed at the right side of the touch screen  TV.

2. Switch to RF IR mode by using the Mode button .

The Device menu appears.

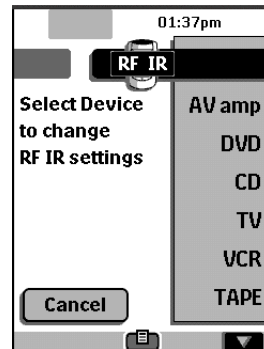

3. Select the device for which you want to change the RF IR settings.

The RF IR settings appear. The white label on the button  IR indicates that the selected device is currently operated with IR signals.

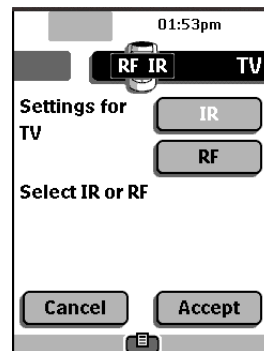

4. Tap RF.

The RF IR settings for the selected device are transferable from IR to RF.

When you have only one RF Receiver, you can accept the default settings for the Extender ID and the Channel. Continue with step 5.

or
When you have several RF Receivers to operate devices, you have to assign the correct Extender ID to the selected device. Follow the instructions as described in "Changing the Extender ID".

Note:

The ID on the RF Receiver has to match the Extender ID on the remote controller.

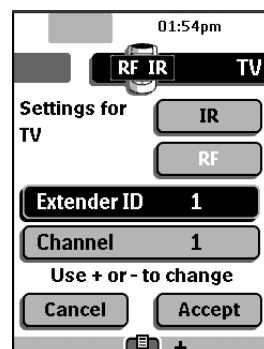

Getting the Maximum out of it

Changing the Extender ID

1. Make sure the Extender ID button is active.
The button is active when the button label is white.
2. Press the + and – action buttons to change the Extender ID.
The remote controller offers 16 Extender ID's.

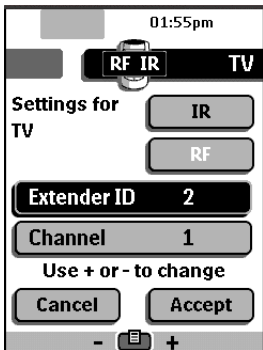

5. Tap **Accept** to save the RF IR settings for the selected device.
or
Tap **Cancel** to return without changing the RF IR settings for the selected device.

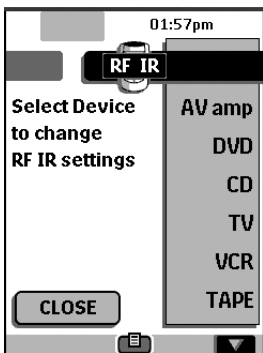

6. Repeat instructions 3 to 5 for all devices for which you want to change the RF IR settings.

7. Tap Close.

The remote controller switches back to Use mode. The remote controller is configured to operate the devices you have set with RF signals.

8. Try the devices of which you just changed the RF IR settings.

Note:

There is a possibility that a device does not respond properly when operated with RF signals. This is mostly due to IR signals that cannot be properly transmitted as RF signals.

In that case, you have to reconfigure the remote controller to operate the device with IR signals again.

Choosing Another Channel

When you notice RF interference, for instance from your neighbors, you have to choose another channel to operate your devices.

Note:

All devices you want to operate with RF signals use the same channel. If you select another channel for one device, the remote controller will automatically change the channel for all devices that work with RF signals.

1. **Switch back to RF IR mode.**

The Device menu appears.

2. **Select a device that is set with RF signals.**

The RF IR settings appear.

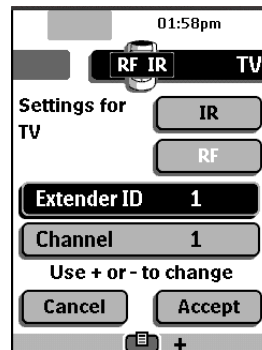

3. Tap **Channel 1**.

The button label turns white indicating that the button is active.

4. **Press the + and – action buttons to change the Channel.**

The remote controller offers 4 RF Channels.

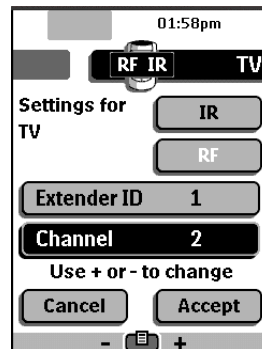

Note:

The Channel (CH) on the RF Receiver has to match the Channel on the remote controller.

5. **Tap Accept to save the selected Channel for all devices that work with RF signals.**

or

Tap Cancel to return without changing the Channel.

6. **Tap Close.**

The remote controller switches back to Use mode. The remote controller is configured to operate the devices you have set with RF signals through the selected Channel.

7. **Try all devices which you just changed the Channel.**

Getting the Maximum out of it

8. ChadEdit

If you want to personalize your remote controller even more, beyond its standard programming features, ChadEdit is the tool for you to use. ChadEdit is the remote controller's companion software that you can download from <http://www.onkyousa.com>
www.integrahometheater.com.

With ChadEdit you can:

- upload and download new configurations to and from your remote controller. You do this with the serial cable included with your remote controller;

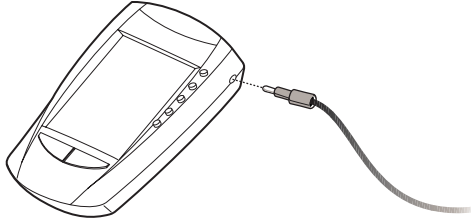

- add, delete, modify and move control panels, devices and commands anywhere on the touchscreen;
- save, duplicate and share configuration files, codes or devices with other remote controllers;
- preview new configuration files on ChadEmulator. In this way you can check how the remote controller's interface will look like.



System requirements

- PC
- Windows 95/98/Me, Windows NT 4.0/2000, Windows XP
- 16 MB of RAM
- 16 MB of free hard disk space
- Free serial port

Troubleshooting

General Problems

The display is blank

- Tap the screen to make sure the Remote controller is turned on.
- Adjust the contrast dial on the left side.
- Make sure the batteries are properly installed.
- Install new batteries or recharge the battery pack using the recharging dock.

The display is too light or too dark

- Adjust the contrast dial on the left side.

The Remote controller shuts itself off

- This is a feature of the Remote controller to save power. You can change the length the Remote controller stays on in the Settings (see page 71).

Devices do not respond to commands from the Remote controller

- Make sure the Remote controller is in Use mode (see page 65).
- Make sure the Remote controller's sending eye is pointed towards the device you are operating.
- Check if the Low Battery icon is blinking. If so, replace the batteries or recharge the battery pack.
- Check if the button you are trying to use is programmed properly (see page 71).

The Remote controller beeps 4 times after inserting the batteries

- Use ChadEdit to update the Remote controller's software (ChadEdit > Tools > Update)

Programming Problems

Buttons are not sending the correct commands

- Check whether the button is programmed globally or per device (see page 73).

Macros do not work

- Make sure the Remote controller's sending eye is pointed towards the device the entire time the macro is being executed.
- Insert delays to allow devices to start up properly (see page 77).
- Check if you do not have included inactive buttons in your macro.
- Check if you do not have reprogrammed buttons. Macros can not save commands, they just save buttons. If you reprogram a button, the macro executes the new command assigned to the button.

The TV goes blank or the input source changes

- The Device menu item might be programmed to switch the input source. Operate the device without affecting the input source (see page 70).

The Remote controller will not edit, label or delete commands

- If the label locked appears on the Remote controller icon, the device control panels have been locked to prevent unwanted changes. You cannot modify or delete commands for this device.
- Make sure your devices are positioned as shown on page 72. Avoid programming the Remote controller under bright fluorescent light: it might affect the infrared signals.
- Make sure the button you want to edit has a border. Borderless buttons cannot be programmed.

The Remote controller will not switch modes

- When the batteries are low the Remote controller prevents you from switching to customizing modes so that no customization can get lost. Replace the batteries (see page 63).

The Remote controller is low on memory

- The remote controller displays a message to clean up the memory. The Remote controller will do this by permanently removing devices and macro and timer groups you have deleted.

Warning:

Cleaning up memory will take 10 minutes or longer. Never remove batteries during the clean-up process. This might damage the configuration file resulting in loss of your customized commands.

The configuration file is corrupted

- When this very unlikely event occurs, you have to revert to the original configuration. All your customized commands devices and macros will be lost and you will have to reprogram your remote controller.

Remote controller error messages

- If one of the following error messages occurs, please contact your dealer or the Integra/Onkyo customer service:
- Can not open configuration file
- Configuration file error
- No configuration file found
- Invalid configuration file version

Recharging Problems

The batteries will not recharge

- Make sure you are using the rechargeable battery pack included with your recharging dock and not the AA batteries.

The indicator light blinks

- Check if the contacts on the recharging dock are clean and free of obstructions.
- Make sure the remote controller lies properly on the dock.
- Make sure the battery pack is installed properly in your remote controller (see page 63).

FAQ

Can I program a button to execute more than one command?

No, you can not. However, you can create a macro to execute a sequence of commands (see page 77).

How do I program source switching?

See “Programming device items” on page 73.

How can I edit, label or delete buttons on home panels?

You can do this via the Device menu items. All changes you make to these items are automatically updated in the Home menu.

How do I reset the Remote controller?

Normally, you never have to reset the Remote controller. However, if the Remote controller’s display freezes or if you notice unusual behavior, you might need to reset. You will not lose any saved programmed commands or macros.

- Carefully press the reset button on the back of the Remote controller with a paperclip or sharp pencil. The remote controller restarts and beeps to indicate it is ready for use.

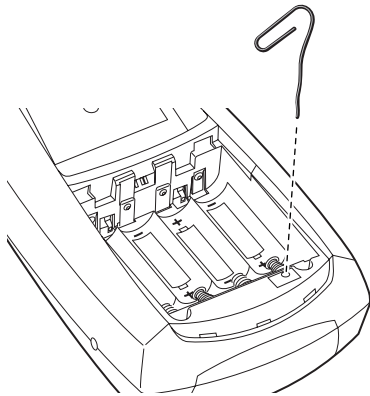

How do I revert to the original configuration?

Reverting to the original configuration restores the remote controller’s devices and commands to its state when you purchased it. This means that all programming is lost permanently. Normally, you never have to revert the Remote controller.

1. Touch and hold the Remote controller icon for a few seconds.

The first setup panel appears.

2. Scroll to the second setup panel.

3. Tap the Revert button.

4. Tap Revert to confirm the action.





























How do I calibrate the touchscreen?





























The remote controller is calibrated when it leaves the factory, so normally you do not have to calibrate it yourself. It is possible that the remote controller displays a message to calibrate the touchscreen. If this message appears, do the following:

1. Tap as close as possible to the arrow tip on the upper left corner of the screen.

2. Tap as close as possible to the arrow tip on the bottom right corner of the screen.

Overview of Symbols

	:Pause
	:Stop
	:Normal run; normal speed
	:Normal run; normal speed
	:Fast run; fast speed
	:Fast run; fast speed
	:Slow run; slow speed
	:Slow run; slow speed
	:Eject
	:Recording, general
	:Key
	:Navigate
	:Still mode
	:Tape running direction
	:Next track
	:Previous track
	:Fast forward to index
	:Rewind to index
	:Frame by frame, general
	:Frame by frame, general
	:Subtitle
	:Cancel picture
	:Picture-in-picture mode
	:Menu
	:Picture-in-picture shift
	:Picture-in-picture swap
	:Multi-picture display
	:Picture-in-picture select
	:Teletext mode

	:Page number up
	:Page number down
	:Page enlargement
	:TV and text mixed
	:1st or 2nd language
	:Last view; previous program
	:Standby
	:Zone focus: long distance
	:Zone focus: very short distance
	:Single or multi-digit selection
	:Brightness; brilliance
	:Contrast
	:Brightness/contrast
	:Color saturation
	:Lamp; lighting; illumination
	:Split screen freeze / double screen freeze
	:Split screen swap / double screen swap
	:Split screen / double screen
	:Movie expand
	:Personal preference
	:Picture-in-picture freeze
	:Main index page
	:Picture freeze
	:Programmable timer; general
	:Tracking
	:Application assistance
	:Actual time on screen
	:EPG / Electronic Program Guide
	:Video output

Specifications

Hardware	High-resolution (320 x 240) liquid crystal display (LCD) with contrast control Large touchscreen Seven programmable direct-access buttons Backlighting for LCD and direct-access buttons Infrared sending and learning eyes 3-wire (RS232) serial port connector
Software	Dynamic, animated interface Editable macros (up to 255 commands per macro) Total number of devices and macros limited only by memory Database with RC codes to operate different brands
Infrared (IR)	Operating distance of 10 meters (33 feet) Learning frequency up to 56 kHz Learning distance 5 cm (2 inch) up to 30 cm (1 foot)
Radio frequency (RF)	Operating distance of approximately 20 meters depending on the surrounding conditions Band:418 MHz Bandwidth: +/-100 kHz 16 Extender ID's and 4 Channels
Memory	2 MB non-volatile flash memory (retains commands when batteries are not present) 512 K SRAM
Batteries	4 AA 1.5 V batteries, or one 4,8V rechargeable battery pack
Battery life	Approximately 6 months with typical use
Power management	Power on by tapping the touchscreen, power off automatically management
Dimensions	153.6 x 94.1 x 43.7 mm (6.0 inch x 3.7 inch x 1.7 inch)
Operating temperature	0 °C to 50 °C (32 °F to 122 °F)
Accessories (Not included)	Remote controller recharge package BCC-5 RF Receiver RFR-5

Database information:

Designed by UEI Technology

Licensed under U.S. Patent 5,689,353

Portions © UEI 1999

The specifications and design of this product are subject to change without notice.

Troubleshooting guide

If a problem occurs while you are using the remote controller, first try to operate the controls on the front panel of the DTR-8.2 to make sure that it is not due to a malfunction (or worn out batteries) in the remote controller.

POWER

Power shuts off immediately after power on.

- Amplifier protection circuitry has been activated.
→ Remove the power cord from outlet immediately. Contact your Integra/Onkyo service center.

No power.

- Power cord is disconnected.
→ Connect power cord.
- External noise is affecting the internal microcomputer.
→ Turn the power button off and then on again or remove the power cord from the outlet and then plug it in again.
- Internal fuse is blown.
→ Contact your Integra/Onkyo Service Center.

Power turns on but no sound.

- "Muting" is displayed.
→ Press the MUTE button on the remote controller to turn it off.
- Bad connections or wiring.
→ Check connections, speaker cables, etc.
- Amplifier protection circuitry has been activated.
→ Contact your Integra/Onkyo Service Center.

The sound of the playback source is not heard.

- Input selector is not set properly.
→ Set to correct input source.
- Headphones are connected.
→ Lower volume and then disconnect headphones.

SPEAKERS

No sound from the center speaker, or at very low volume.

- Speaker cable is not connected.
→ Check the connection between the amplifier and the speaker.
- Listening mode is set to Stereo or Direct.
→ Set the Listening mode to any mode other than Stereo or Direct. The output to the center speaker may differ depending on the listening mode.
- Center speaker level is set to minimum.
→ Set the Center speaker level to the appropriate volume (page 34).
- The Center setting of the Speaker Config submenu is set to "None."
→ Set the Center setting at the Speaker Config sub-menu to "Large" or "Small" (see page 32).

No sound or very low volume from subwoofer.

- Subwoofer is set to "No."
→ Check the speaker setting (pages 32, 43).
- Subwoofer speakers output level setting is improper.
→ Check the output level of the Subwoofer using the test tone.

Low frequency humming is heard.

- Not properly grounded.
→ Check outer conductor of input plugs.

- Turntable motor is not properly grounded.
→ Check for proper ground connection.
- Audio connection cables on the rear panel are connected incorrectly.
→ Adjust the placement of the cable to reduce hum.

Howling is heard when the volume is turned up.

- Turntable and speakers are located too close together.
→ Move them farther apart.

Rough or scratchy sound is heard. High range is not clear.

- The needles of turntable is dirty or worn, or a problem exists with a connected component.
→ Refer to the instruction of the connected components and check for problem.
- Treble control is too high.
→ Turn treble down (see page 43).

FM/AM TUNER

AM stations cannot be received.

- AM loop antenna is not connected.
→ Connect the included AM loop antenna to the AM antenna terminals.

Buzzing noise on AM stations (particularly noticeable at night or with weak stations).

- Noise from electrical apparatus such as fluorescent lamp.
→ Move the AM loop antenna to different position.
→ Set up an outdoor AM antenna.

Noise is heard at high-pitched sounds on AM stations.

- Noise from TV set.
→ Place the AM loop antenna as far as possible from the TV.
→ Move unit away from TV set.

Crackling noise on both AM and FM stations.

- Noise caused by fluorescent lamp being turned on and off.
→ Move antenna as far as possible from the fluorescent lamp.
- Noise from automobile ignition.
→ Install an FM outdoor antenna as far as possible from the road.
→ Change the position or direction of the outdoor antenna.

The indicators light for stereo reception, but sound is distorted and stereo separation is bad.

- Station is too strong.
→ Change to FM indoor antenna.
- Multiple reflection of the radio waves because of tall buildings or mountains.
→ Use antenna that has better directivity and select a point where distortion is least.

Indicators for stereo reception flicker and hiss is heard on FM stations.

- Station is too weak.
→ Install an outdoor FM antenna.
- Stereo FM broadcasts cover only about half the distance of an ordinary broadcast.
→ Change the position or direction of the outdoor antenna.

No preset station is recalled.

- Power cord has been unplugged or the POWER switch has been turned off for a long time.
→ The memory contents are lost. Store all stations again.

Troubleshooting guide

VIDEO and AUDIO

Desired picture does not appear.

- Improper connection.
→ Check the connection again. Insert the plugs and connectors completely.

No OSD Menu display.

- Improper connection.
→ Check connections.
- OSD Menu is displayed when monitor is connected to VIDEO or S VIDEO or MONITOR OUT.
→ Confirm connections (see page 21).

No sound, or sound of the selected source is not heard.

- Input Setup menu settings are incorrect.
→ Check settings (see page 36).

No picture appears on the TV screen (or monitor).

- TV (or monitor) is not set to receive the output signals from the receiver.
→ Set the TV (or monitor) to the receiver input.
- Video cable is not connected securely.
→ Check connections.
- You have connected to the COMPONENT VIDEO connectors but the DTR-8.2 is not set properly.
→ Check the Video Setup submenu of the Input Setup menu (page 19).

OTHER

LATE NIGHT function cannot be used.

- Playback source is not Dolby Digital encoded.
→ Check that the DOLBY DIGITAL indicator lights up on the display.

Re-EQ function cannot be used.

- Listening mode is set to Theater-Dimensional, or Direct/Pure Audio.
→ See page 46.

Parameter cannot be set for Front Effect etc.

- Parameter may not be able to be set depending on the listening mode.
→ See table on page 46.

Multichannel audio is not output.

- To listen to multichannel audio, "Yes" must be selected in the "Multichannel" in the Multichannel setup sub-menu of the Input Setup menu. Also, it is necessary to select Multichannel with the Audio Selector button.
→ Check that the component is connected to the MULTI CHANNEL INPUT port and check the Setup menu settings.

Components in remote zone (Zone 2) do not operate properly.

- Components are incorrectly connected.
→ Check connections.
- Objects are interfering with remote controller signals.
→ Move interfering objects away from path of remote controller signals.

If one of the messages shown below appears

"Not available with headphones use"

The operation is not allowed because headphones are plugged into the DTR-8.2.

"Not available with Multichannel use"

Cannot be used while the multichannel output is being used.

"Not available in this Sp Config"

Will not work with the current speaker configuration settings.

"Not available in Zone 2 mode"

The operation is not allowed because the Zone 2 mode is turned on.

"Only available with Dolby D"

No setting other than Dolby Digital can be set.

"Not available in this Listening mode"

Will not work with the current listening mode.

"Not available with this signal"

The listening mode cannot be selected with the current input source.

"Powered Zone 2 is not Activated"

Will not work with the Zone 2 output set to non-activated (Not Activated).

"Not available with Muting"

Will not work because the muting is activated.

"Zone 2 is not On"

Will not work because the Zone 2 has not been turned on.

Also refer to the respective instruction manuals of the compact disc player, DVD player, video cassette recorder, TV monitor, etc., that compose your entertainment system.

The DTR-8.2 contains an internal microcomputer that performs high-level operations. However, on extremely rare occasions, noise or interference from an external source or static electricity may cause faulty operation. If this occurs, unplug the power cord from the wall outlet, wait five or more seconds, and then plug it back in. This should correct the situation.

- * To reset the surround mode and other settings to the factory default settings, hold down the Video 1 button with the DTR-8.2 turned on and then press the Standby/On button. "CLEAR" appears in the front display and the DTR-8.2 enters the standby state.

Specifications

AMPLIFIER SECTION

Continuous Average Power output (FTC)	
All channels:	110 watts per channel min. RMS at 8 ohms, 2 channels driven from 20 Hz to 20 kHz with no more than 0.08% total harmonic distortion. 145 watts min. RMS at 6 ohms, 2 channels driven from 1 kHz with no more than 0.1% total harmonic distortion.
Continuous Power output (DIN)	150 watts at 6 ohms
Maximum Power output (EIAJ)	180 watts at 6 ohms
Dynamic Power Output (Stereo)	2 × 280 watts at 3 ohms 2 × 220 watts at 4 ohms 2 × 140 watts at 8 ohms
Total Harmonic Distortion:	0.08% at rated power 0.08% at 1 Watt output
IM Distortion:	0.08% at rated power 0.08% at 1 Watt output
Damping Factor:	60 at 8 ohms
Input Sensitivity and Impedance	
PHONO:	2.5 mV, 50 kohms
LINE (CD, TAPE, DVD, VIDEO 1-5):	200 mV, 50 kohms
MULTICHANNEL INPUT (FRONT L/C/R, SURROUND L/R, SURROUND BACK L/R):	200 mV, 50 kohms
(SUBWOOFER):	36 mV, 50 kohms
COAXIAL 1, 2, 3 (DIGITAL):	0.5 Vp-p, 75 ohms
DVD, VIDEO 1, 2, 3, 4, 5:	1 Vp-p, 75 ohms 1 Vp-p, 75 ohms (Y) 0.28 Vp-p, 75 ohms (C)
COMPONENT VIDEO 1, 2:	1 Vp-p, 75 ohms (Y) 0.7 Vp-p, 75 ohms (PB, PR)
Output Level and Impedance	
Rec out (TAPE, VIDEO 1, 2):	200 mV, 470 ohms
Pre out:	1 V, 470 ohms
ZONE 2 OUT:	100mV, 470 ohms
VIDEO (VIDEO 1, 2, MONITOR OUT, ZONE 2 OUT):	1 Vp-p, 75 ohms 1 Vp-p, 75 ohms (Y) 0.28 p-p, 75 ohms (C)
COMPONENT VIDEO OUT:	1 Vp-p, 75 ohms (Y) 0.7 Vp-p, 75 ohms (PB, PR)
Phono Overload:	120 mV RMS at 1 kHz, 0.5% T.H.D.
Frequency Response:	5 Hz to 100 kHz : +1/-3 dB (CD in Direct mode)
RIAA Deviation:	20 Hz to 20 kHz : ±0.8 dB
Tone Control	
Bass:	±10 dB at 50 Hz
Treble:	±10 dB at 20,000 Hz
Signal-to-Noise Ratio (Stereo)	
Phono:	80 dB (IHF A, 5 mV input)
CD/Tape:	110 dB (IHF A, 0.5 V input)

TUNER SECTION

FM	
Tuning Range:	87.5 — 108.0 MHz (50 kHz steps)
Usable Sensitivity	
Mono:	11.2 dBf, 1.0 μV (75 ohms IHF) 0.9 μV (75 ohms DIN)
Stereo:	17.2 dBf, 2.0 μV (75 ohms IHF) 23 μV (75 ohms DIN)
50 dB Quieting Sensitivity	
Mono:	17.2 dBf, 2.0 μV (75 ohms)
Stereo:	37.2 dBf, 20 μV (75 ohms)
Capture Ratio:	2.0 dB
Image Rejection Ratio	40 dB
IF Rejection Ratio:	90 dB
Signal-to-Noise Ratio	
Mono:	76 dB
Stereo:	70 dB
Alternate Channel Attenuation:	55 dB
Selectivity:	50 dB (DIN)
AM Suppression Ratio:	50 dB
Total Harmonic Distortion	
Mono:	0.2%
Stereo:	0.3%
Frequency Response:	30 Hz — 15 kHz, ±1.0 dB
Stereo Separation:	45 dB at 1 kHz 30 dB at 100 Hz — 10 kHz
AM	
Tuning Range:	530—1,710 kHz (10 kHz steps)
Usable Sensitivity:	30 μV
Image Rejection Ratio:	40 dB
IF Rejection Ratio:	40 dB
Signal-to-Noise Ratio:	40 dB
Total Harmonic Distortion:	0.7%

GENERAL

Power Supply:	AC 120 V, 60 Hz
Power Consumption:	7.8 A
Dimensions (W × H × D):	17-1/8" × 6-7/8" × 18-1/8"
Weight:	38.4 lbs.

REMOTE CONTROLLER

Transmitter:	Infrared
Signal range:	Approx. 5 meters, 16 ft.
Power supply:	Two "AA" batteries (1.5 V × 2)

Specifications and features are subject to change without notice.

Integra Division of
ONKYO U.S.A. CORPORATION
18 Park Way, Upper Saddle River, N.J. 07458, U.S.A.
Tel: 201-785-2600 Fax: 201-785-2650 <http://www.integrahometheater.com>

Integra Division of
ONKYO CORPORATION
Sales & Product Planning Div. : 2-1, Nisshin-cho, Neyagawa-shi, OSAKA 572-8540, JAPAN
Tel: 072-831-8111 Fax: 072-833-5222



Free Manuals Download Website

<http://myh66.com>

<http://usermanuals.us>

<http://www.somanuals.com>

<http://www.4manuals.cc>

<http://www.manual-lib.com>

<http://www.404manual.com>

<http://www.luxmanual.com>

<http://aubethermostatmanual.com>

Golf course search by state

<http://golfingnear.com>

Email search by domain

<http://emailbydomain.com>

Auto manuals search

<http://auto.somanuals.com>

TV manuals search

<http://tv.somanuals.com>