

Integra

AV Receiver

DTR-9.1

Instruction Manual

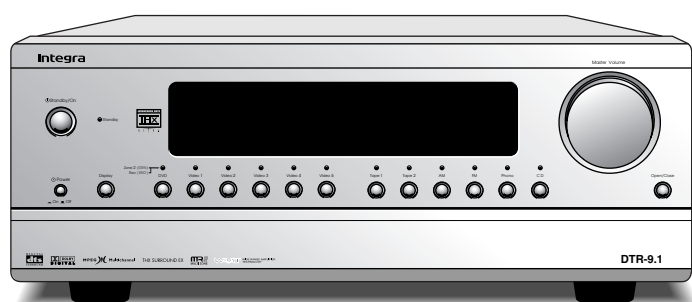

Thank you for purchasing the **Integra** AV Receiver.

Please read this manual thoroughly before making connections and plugging in the unit. Following the instructions in this manual will enable you to obtain optimum performance and listening enjoyment from your new AV Receiver. Please retain this manual for future reference.

Contents

Before using

Facilities and connections

Setting OSD menu

Enjoying music or videos

Remote controller

Appendix

WARNING:

TO REDUCE THE RISK OF FIRE OR ELECTRIC SHOCK, DO NOT EXPOSE THIS APPLIANCE TO RAIN OR MOISTURE.

CAUTION:

TO REDUCE THE RISK OF ELECTRIC SHOCK, DO NOT REMOVE COVER (OR BACK). NO USER-SERVICEABLE PARTS INSIDE. REFER SERVICING TO QUALIFIED SERVICE PERSONNEL.



The lightning flash with arrowhead symbol, within an equilateral triangle, is intended to alert the user to the presence of uninsulated "dangerous voltage" within the product's enclosure that may be of sufficient magnitude to constitute a risk of electric shock to persons.



The exclamation point within an equilateral triangle is intended to alert the user to the presence of important operating and maintenance (servicing) instructions in the literature accompanying the appliance.

Important Safeguards

- Read Instructions** - All the safety and operating instructions should be read before the appliance is operated.
- Retain Instructions** - The safety and operating instructions should be retained for future reference.
- Heed Warnings** - All warnings on the appliance and in the operating instructions should be adhered to.
- Follow Instructions** - All operating and use instructions should be followed.
- Cleaning** - Unplug the appliance from the wall outlet before cleaning. The appliance should be cleaned only as recommended by the manufacturer.
- Attachments** - Do not use attachments not recommended by the appliance manufacturer as they may cause hazards.
- Water and Moisture** - Do not use the appliance near water - for example, near a bath tub, wash bowl, kitchen sink, or laundry tub; in a wet basement; or near a swimming pool; and the like.
- Accessories** - Do not place the appliance on an unstable cart, stand, tripod, bracket, or table. The appliance may fall, causing serious injury to a child or adult, and serious damage to the appliance. Use only with a cart, stand, tripod, bracket, or table recommended by the manufacturer, or sold with the appliance. Any mounting of the appliance should follow the manufacturer's instructions, and should use a mounting accessory recommended by the manufacturer.
- An appliance and cart combination should be moved with care. Quick stops, excessive force, and uneven surfaces may cause the appliance and cart combination to overturn.
- Ventilation** - Slots and openings in the cabinet are provided for ventilation and to ensure reliable operation of the appliance and to protect it from overheating, and these openings must not be blocked or covered. The openings should never be blocked by placing the appliance on a bed, sofa, rug, or other similar surface. The appliance should not be placed in a built-in installation such as a bookcase or rack unless proper ventilation is provided. There should be free space of at least 20 cm (8 in.) and an opening behind the appliance.
- Power Sources** - The appliance should be operated only from the type of power source indicated on the marking label. If you are not sure of the type of power supply to your home, consult your appliance dealer or local power company.
- Grounding or Polarization** - The appliance may be equipped with a polarized alternating current line plug (a plug having one blade wider than the other). This plug will fit into the power outlet only one way. This is a safety feature. If you are unable to insert the plug fully into the outlet, try reversing the plug. If the plug should still fail to fit, contact your electrician to replace your obsolete outlet. Do not defeat the safety purpose of the polarized plug.
- Power-Cord Protection** - Power-supply cords should be routed so that they are not likely to be walked on or pinched by items placed upon or against them, paying particular attention to cords at plugs, convenience receptacles, and the point where they exit from the appliance.
- Outdoor Antenna Grounding** - If an outside antenna or cable system is connected to the appliance, be sure the antenna or cable system is grounded so as to provide some protection against voltage surges and built-up static charges. Article 810 of the National Electrical Code, ANSI/NFPA 70, provides information with regard to proper grounding of the mast and supporting structure, grounding of the lead-in wire to an antenna-discharge unit, size of grounding conductors, location of antenna-discharge unit, connection to grounding electrodes, and requirements for the grounding electrode. See Figure 1.
- Lightning** - For added protection for the appliance during a lightning storm, or when it is left unattended and unused for long periods of time, unplug it from the wall outlet and disconnect the antenna or cable system. This will prevent damage to the appliance due to lightning and power-line surges.
- Power Lines** - An outside antenna system should not be located in the vicinity of overhead power lines or other electric light or power circuits, or where it can fall into such power lines or circuits. When installing an outside antenna system, extreme care should be taken to keep from touching such power lines or circuits as contact with them might be fatal.
- Overloading** - Do not overload wall outlets, extension cords, or integral convenience receptacles as this can result in a risk of fire or electric shock.
- Object and Liquid Entry** - Never push objects of any kind into the appliance through openings as they may touch dangerous voltage points or short-out parts that could result in a fire or electric shock. Never spill liquid of any kind on the appliance.
- Servicing** - Do not attempt to service the appliance yourself as opening or removing covers may expose you to dangerous voltage or other hazards. Refer all servicing to qualified service personnel.
- Damage Requiring Service** - Unplug the appliance from the wall outlet and refer servicing to qualified service personnel under the following conditions:
 - When the power-supply cord or plug is damaged,
 - If liquid has been spilled, or objects have fallen into the appliance,
 - If the appliance has been exposed to rain or water,
 - If the appliance does not operate normally by following the operating instructions. Adjust only those controls that are covered by the operating instructions as an improper adjustment of other controls may result in damage and will often require extensive work by a qualified technician to restore the appliance to its normal operation,
 - If the appliance has been dropped or damaged in any way, and
 - When the appliance exhibits a distinct change in performance - this indicates a need for service.

PORTABLE CART WARNING



S3125A

21. **Replacement Parts** – When replacement parts are required, be sure the service technician has used replacement parts specified by the manufacturer or have the same characteristics as the original part. Unauthorized substitutions may result in fire, electric shock, or other hazards.
22. **Safety Check** – Upon completion of any service or repairs to the appliance, ask the service technician to perform safety checks to determine that the appliance is in proper operation condition.
23. **Wall or Ceiling Mounting** – The appliance should be mounted to a wall or ceiling only as recommended by the manufacturer.
24. **Heat** – The appliance should be situated away from heat sources such as radiators, heat registers, stoves, or other appliances (including amplifiers) that produce heat.

FIGURE 1:
EXAMPLE OF ANTENNA GROUNDING AS PER NATIONAL
ELECTRICAL CODE, ANSI/NFPA 70

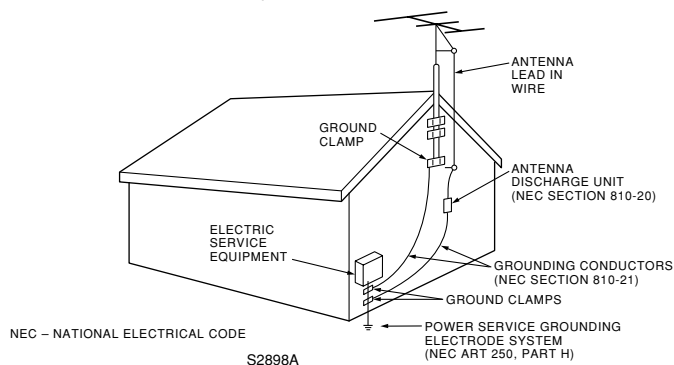

Precautions

1. Warranty Claim

You can find the serial number on the rear panel of this unit. In case of warranty claim, please report this number.

2. Recording Copyright

Recording of copyrighted material for other than personal use is illegal without permission of the copyright holder.

3. AC Fuse

The fuse is located inside the chassis and is not user-serviceable. If power does not come on, contact your Onkyo authorized service station.

4. Care

From time to time you should wipe the front and rear panels and the cabinet with a soft cloth. For heavier dirt, dampen a soft cloth in a weak solution of mild detergent and water, wring it out dry, and wipe off the dirt. Following this, dry immediately with a clean cloth. Do not use rough material, thinners, alcohol or other chemical solvents or cloths since these could damage the finish or remove the panel lettering.

5. Power

WARNING

BEFORE PLUGGING IN THE UNIT FOR THE FIRST TIME, READ THE FOLLOWING SECTION CAREFULLY.

The voltage of the available power supply differs according to country or region. Be sure that the power supply voltage of the area where this unit will be used meets the required voltage (e.g., AC 120 V, 60 Hz) written on the rear panel.

Precautions during unpacking

- The unit is extremely heavy, so be careful when lifting it so as not to cause an injury. Do not lift or move the unit by holding it at the door on the front panel. Doing so may damage the front door.
- When packaged, the door on the front panel is taped to the unit. Before use, be sure to remove this tape.

Taped

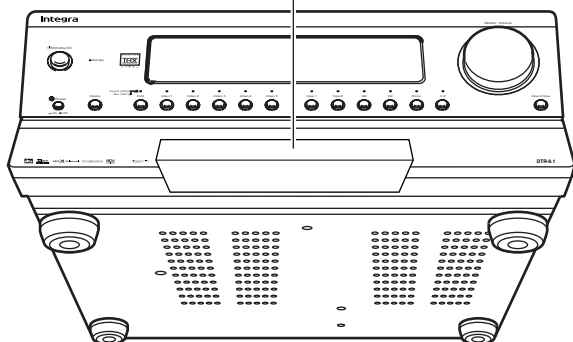

For U.S. model

Note to CATV system installer:

This reminder is provided to call the CATV system installer's attention to Article 820-40 of the NEC, ANSI/NFPA 70, which provides guidelines for proper grounding and, in particular, specifies that the cable ground shall be connected to the grounding system of the building, as close to the point of cable entry as practical.

FCC Information for User

CAUTION:

The user changes or modifications not expressly approved by the party responsible for compliance could void the user's authority to operate the equipment.

NOTE:

This equipment has been tested and found to comply with the limits for a Class B digital device, pursuant to Part 15 of the FCC Rules. These limits are designed to provide reasonable protection against harmful interference in a residential installation. This equipment generates, uses and can radiate radio frequency energy and, if not installed and used in accordance with the instructions, may cause harmful interference to radio communications. However, there is no guarantee that interference will not occur in a particular installation. If this equipment does cause harmful interference to radio or television reception, which can be determined by turning the equipment off and on, the user is encouraged to try to correct the interference by one or more of the following measures:

- Reorient or relocate the receiving antenna.
- Increase the separation between the equipment and receiver.
- Connect the equipment into an outlet on a circuit different from that to which the receiver is connected.
- Consult the dealer or an experienced radio/TV technician for help.

For Canadian model

CAUTION: THIS DIGITAL APPARATUS DOES NOT EXCEED THE CLASS B LIMITS FOR RADIO NOISE EMISSION FROM DIGITAL APPARATUS SET OUT IN THE RADIO INTERFERENCE REGULATIONS OF THE CANADIAN DEPARTMENT OF COMMUNICATIONS.

For models having a power cord with a polarized plug:

CAUTION: TO PREVENT ELECTRIC SHOCK, MATCH WIDE BLADE OF PLUG TO WIDE SLOT, FULLY INSERT.

Modele pour les Canadien

ATTENTION: L'INTERFÉRENCE RADIO ÉLECTRIQUE GÉNÉRÉE PAR CET APPAREIL NUMÉRIQUE DE TYPE B NE DÉPASSE PAS LES LIMITES ÉNONCÉES DANS LE RÈGLEMENT SUR LES PERTURBATIONS RADIO ÉLECTRIQUES, SECTION APPAREIL NUMÉRIQUE, DU MINISTÈRE DES COMMUNICATIONS.

Sur les modèles dont la fiche est polarisée:

ATTENTION: POUR ÉVITER LES CHOCS ÉLECTRIQUES, INTRODUIRE LA LAME LA PLUS LARGE DE LA FICHE DANS LA BORNE CORRESPONDANTE DE LA PRISE ET POUSSER JUSQU'AU FOND.

Contents

Before using

Important Safeguards	2
Precautions	3
Contents	4
Supplied accessories	5
Features	6
Before using remote controller	7
Installing the remote controller batteries	7
Using the remote controller	7

Facilities and connections

Front panel facilities	8
Front panel	9
Front panel door	9
Front panel display	10
Remote controller	11
Rear panel facilities	12
Example of how to connect your equipment	16
Standard connections	17
Connecting your audio components	18
Connecting your video components	18
Connecting speakers	20
Ideal speaker configuration	20
Minimum speaker configuration for surround sound playback	20
Speaker placement	20
Connecting speakers	21
Connecting the speaker cable	21
Connecting a subwoofer	21
Connecting antennas	22
Connecting the included antennas	22
Assembling the AM loop antenna	22
Connecting the AM antenna cable	22
Connecting an FM outdoor antenna	23
Connecting an AM outdoor antenna	23
Directional linkage	23
Connecting to the IR IN ZONE 2 input	24
Outline	24
Connecting the main and remote zones	24
Connecting to the IR IN MAIN input	25
Outline	25
Connecting a graphic equalizer and power amplifiers	26
Connecting a graphic equalizer	26
Connecting power amplifiers	26
Connecting the power	27
Connecting the power	27

Setting OSD menu

The On-Screen Display (OSD) menu	28
Navigating through the OSD menu	29
Speaker Setup	30
1. Speaker Setup menu	30
1-1. Speaker Config sub-menu	30
1-2. Speaker Distance sub-menu	31
1-3. Level Calibration sub-menu	32
1-4. Bass Peak Level sub-menu	33
1-5. LFE Level Setup sub-menu	33
Input Setup	34
2. Input Setup menu	34
2-1. Digital Setup sub-menu	34
2-2. Multichannel Setup sub-menu	36
2-3. Video Setup sub-menu	36
2-4. Listening Mode Preset sub-menu	37
Input source signals	38
Listening Modes	38
2-5. Delay sub-menu	40
2-6. Sound Effect sub-menu	40
2-7. Character Input sub-menu	41
2-8. Miscellaneous Setup	41
Listening Mode Setup	42
3. Listening Mode Setup menu	42
Description listening mode parameters	44
Preference	46
4. Preference menu	46
4-1. Volume Setup sub-menu	46
4-2. OSD Setup sub-menu	47
4-3. OSD Tweak	47
Zone2 OSD Setup	48
5. Zone2 OSD Setup menu	48
About	48
6. About menu	48
6-1. Lock Setup sub-menu	48
6-2. Version	48

Enjoying music or videos

Enjoying music or videos in the remote zone	49
Controlling the DTR-9.1 from the remote zone	49
Controlling the DTR-9.1 without the remote controller	49
Listening to Radio Broadcasts	50
Listening to FM/AM Radio Stations	50
Tuning into a radio station	50
Presetting a radio station	51
Selecting a preset radio station	51
Erasing a preset radio station	51

Contents

Enjoying music or videos with the DTR-9.1 52

- Selecting an input source 52
- Adjusting the volume 52
- Changing the listening mode 52
- Listening with headphones 52
- Using the many features of the DTR-9.1 52
- If one of the messages shown below appears 53
- Enjoying the multichannel output 53

Recording a source 54

- To record the input source signal you are currently watching or listening to 54
- To record an input source signal different from that you are currently watching or listening to 55
- Recording the video from one source and the audio from another 55

Remote controller

Using remote controller 56

- Overview 56
- Using the remote controller to control each device 56
- Controlling the DTR-9.1 56
- Controlling an Integra CD player 58
- Controlling an Integra MD recorder 58
- Controlling an Integra cassette tape deck 59
- Calling up a preset radio station 59
- Controlling an Integra DVD player 60
- SAT, CABLE, VCR, and TV MODE buttons 60

Programming the commands of remote controllers for other devices into the remote controller 61

- Programming procedure 61
- Erasing the programmed command from one button 63

- Erasing all the commands programmed under a MODE button 63

Using a Macro function 64

- What is a Macro function? 64
- Programming a Macro function 64
- Running a Macro function 64
- Programming the Direct Macro function 65
- Running a Direct Macro function 65
- Erasing a macro from the MODE MACRO button 66
- Erasing a direct macro from the DIRECT MACRO button 66
- Erasing all commands and macros that have been programmed 67

Appendix

Troubleshooting guide 68

- POWER 68
- SPEAKERS 68
- FM/AM TUNER 69
- VIDEO and AUDIO 69
- REMOTE CONTROLLER 69
- OTHER 70

The default settings 71

Your system setting 72

- Inputs 72
- Speakers 74
- OSD Setup 74
- ZONE2 74
- About 74
- Remote controller 75
- (Macro mode programming memo 67)

Specifications 76

Supplied accessories

Check that the following accessories are supplied with the DTR-9.1.

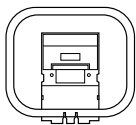

AM loop antenna × 1

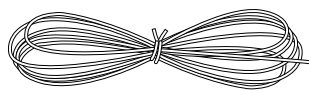

T-shaped FM antenna × 1

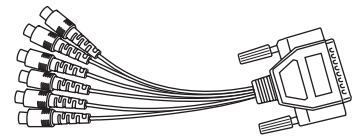

DB-25 ↔ RCA 6ch cable × 1

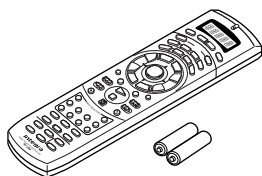

Remote controller × 1
Batteries (AA, R6, or UM-3) × 2

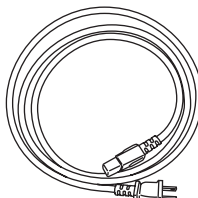

Power cord × 1

Features

AMPLIFIER FEATURES

- **130 WATTS MINIMUM OF CONTINUOUS RMS POWER** to each of the 7 channels into 8 Ω , from 20 Hz to 20 kHz with no more than 0.05%THD (FTC rating)—clean high-current amplification provides incredible dynamic range for seamless reproduction of even the most demanding cinema soundtracks, as well as animatedly rich music at any volume level.
- **7.1-CHANNEL AMPLIFIER**—the first receiver to achieve this feat in one chassis—the DTR-9.1 provides unparalleled power and clarity to all 7.1-channels for a room-filling sound experience seconds to none.
- **LUCASFILM THX® ULTRA CERTIFIED**—in addition to the amazing ability to drive 7.1 channels, the DTR-9.1 also boasts the distinction of carrying the exclusive THX Ultra badge of approval—assurance that this receiver passed (and often exceeds) THX's numerous requirements in such areas as frequency response, distortion, power output, and stability.
- **192kHz/24-BIT D/A CONVERTERS FOR ALL CHANNELS**—the first receiver in the industry to utilize these powerful converters for all seven channels—the DTR-9.1's DACs not only boast a dynamic range of 120dB, they also process more information faster and are virtually resistant to clock jitter, to ensure the best performance possible from DVD-Audio and other upcoming formats, while also producing cleaner, clearer sound from DVDs and CDs.

- **WIDE RANGE AMPLIFIER TECHNOLOGY(WRAT)** WRAT virtually eliminates the adverse effects of counter-electromotive force by: 1) applying an uncommonly low amount of NFB (negative feed-back), 2) using carefully selected, high-tolerance, wide range parts in all critical sections, and 3) incorporating innovative circuit topology based upon decades of high-end amplifier-design experience—the final result is a flat response beyond 100kHz, making the DTR-9.1 ideal for such high-resolution formats as DVD-Audio and Super Audio CD, and other upcoming digital formats.

FLEXIBILITY FEATURES

- **FUTURE-PROOF INTERFACE ARCHITECTURE**—a versatile RS232 port allows the DTR-9.1's powerful 4Mbit Flash Memory to be directly computer accessed for installing such future upgrades as new DSP algorithms, new surround formats/parameters, and other types of processing updates.
- **ZONE 2 MULTIROOM/MULTISOURCE CAPABILITY**—a full set of line outs for audio, composite video, and S-video, allows for set-up of an additional system in another room—connect an optional infrared eye in Zone 2, and complete second-room control can be achieved with such A/V distribution control systems as Xantech®, Niles®, to name but a few.

AUDIO/VIDEO FEATURES

- **THX SURROUND EX® BUILT IN** to decode the additional two back surround channels from THX Surround EX-encoded DVDs and laserdiscs, for incredibly real 360° surround sound effects and precise sound location.
- **DTS® DECODER BUILT IN** to decode the impeccable 5.1-channel digital audio from DTS-encoded DVD-Video discs, DVD-Audio discs, CDs and laserdiscs.
- **DOLBY® DIGITAL DECODER BUILT IN** to decode the 5.1-channel crystal-clear digital audio of DVDs, Digital TV, HDTV, satellite broadcasts and other sources.
- **DOLBY® PRO LOGIC™ DECODER**
- **MPEG DECODEING** for full compatibility with MPEG-encoded software and broadcasts.
- **DIGITAL UPSAMPLING MODE**—the first receiver to have 192kHz/24-bit DACs for all channels enables the DTR-9.1 to take a 48kHz digital signal and double its sampling frequency to 96kHz—twice as much signal information, for greater detail and clarity.
- **THEATER-DIMENSIONAL™ VIRTUAL SURROUND MODE** to transform two speakers into a complete virtual surround sound system
- **A/V SYNC DELAY**
- **LUCASFILM THX® ULTRA FULL-ENHANCEMENT PACKAGE**—includes such sophisticated DSP enhancements as Cinema Re-EQ™, Timbre Matching™, Adaptive Decorrelation™, and Bass Management™ to ensure accurate reproduction of the movie-theater experience in the home.

- **7.1-CHANNEL EXTERNAL INPUTS**
- **COMPONENT VIDEO OUTPUTS**

OTHER FEATURES

- **40 FM/AM RANDOM PRESETS**
- **INTELLIVOLUME**
- **ABSOLUTE/RELATIVE SWITCHABLE VOLUME DISPLAY**
- **ASSIGNABLE and CONFIGURABLE 12-Volt TRIGGERS FOR CUSTOM INSTALLATION APPLICATIONS**
- **ASSIGNABLE and CONFIGURABLE 12-volt TRIGGERS FOR CUSTOM INSTALLATION APPLICATION.**

* Manufactured under license from Dolby Laboratories. "Dolby", "Pro Logic" and the double-D symbol  are trademarks of Dolby Laboratories. Confidential Unpublished Works. ©1992-1997 Dolby Laboratories, Inc. All rights reserved.

- Lucasfilm, THX, THX Ultra and THX Surround EX are registered trademarks of Lucasfilm LTD.
- Re-Equalization and the "Re-EQ" logo are trademarks of Lucasfilm Ltd. Manufactured under license of Lucasfilm Ltd.
- Manufactured under license from Digital Theater Systems, Inc. US Pat. No.5,451,942 and other worldwide patents issues and pending. "DTS" and "DTS Digital Surround" are trademarks of Digital Theater Systems, Inc.© 1996 Digital Theater Systems, Inc. All rights reserved.
- Theater-Dimensional and  mark are trademarks of Onkyo Corporation.
- Xantech is a registered trademark of Xantech Corporation.
- Niles is a registered trademark of Niles Audio Corporation.

THX Ultra

Before any home theatre component can be THX Ultra certified, it must pass a rigorous series of quality and performance tests. Only then can a product feature the THX Ultra logo, which is your guarantee that the Home Theatre products you purchase will give you superb performance for many years to come. THX Ultra requirements define hundreds of parameters, including power amplifier performance, and pre-amplifier performance and operation for both digital and analog domains. THX Ultra receivers also features proprietary THX technologies (e.g. THX Mode, see page 38) which accurately translate film soundtracks for home theater playback.

Before using remote controller

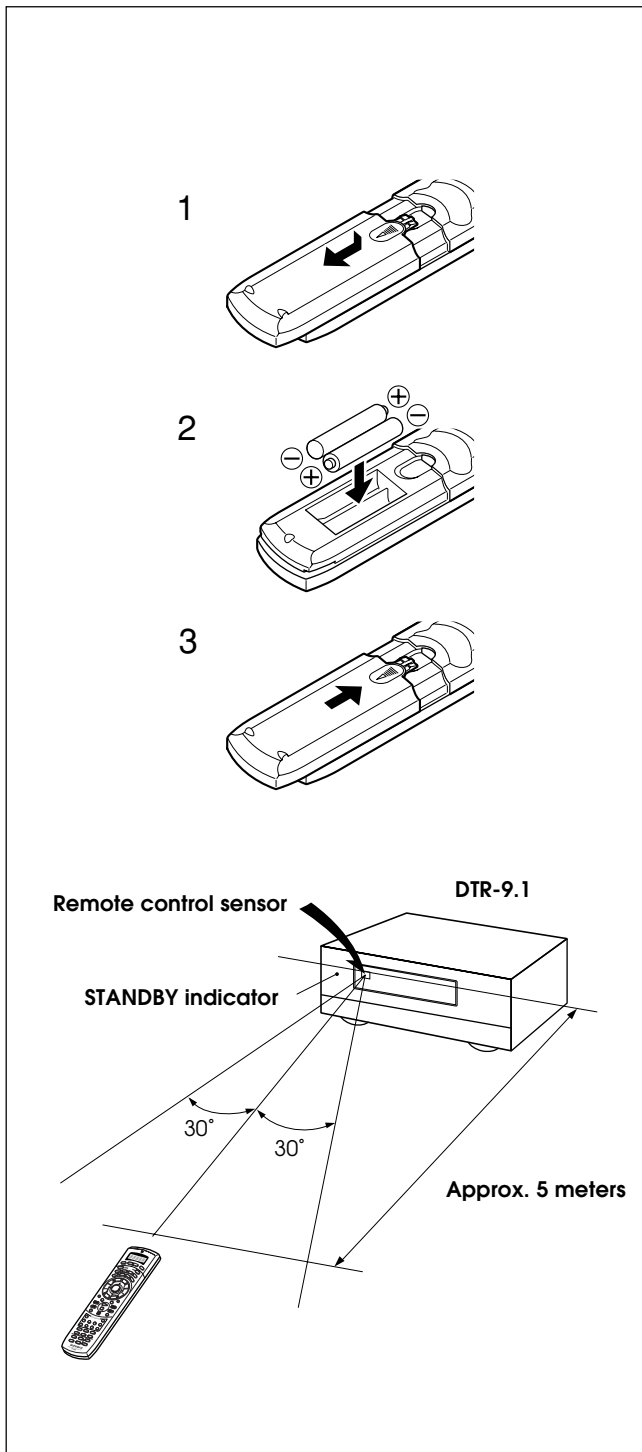

Installing the remote controller batteries

1. Remove the battery compartment cover by pressing the tab and sliding the cover.
2. Insert two AA (R6 or UM-3) batteries into the battery compartment. Carefully follow the polarity diagram (positive (+) and negative (-) symbols) inside the battery compartment.
3. After batteries are installed and seated correctly, replace the compartment cover.

Notes:

- Do not mix new batteries with old batteries or different kinds of batteries.
- To avoid corrosion, remove the batteries if the remote controller is not to be used for a long time.
- Remove dead batteries immediately to avoid damage from corrosion. If the remote controller does not operate smoothly, replace both the batteries at the same time.
- The life of the batteries supplied is about six months but this will vary depending on usage.

Using the remote controller

Point the remote controller toward the remote control sensor. The STANDBY indicator lights up when the unit receives a signal from the remote controller.

Notes:

- Place the unit away from strong light such as direct sunlight or inverted fluorescent light which can prevent proper operation of the remote controller.
- Using another remote controller of the same type in the same room or using the unit near equipment which uses infrared rays may cause operational interference.
- Do not put objects on the remote controller. The buttons of the remote controller may be pressed by mistake and drain the batteries.
- Make sure the audio rack doors do not have colored glass. Placing the unit behind such doors may prevent proper remote controller operation.
- If there is any obstacle between the remote controller and the remote control sensor, the remote controller will not operate.

Memory preservation

This unit does not require memory preservation batteries. A built-in memory power backup system preserves the contents of the memory during power failures and even when the POWER switch is set to off. The POWER switch must be set to on in order to charge the backup system.

The memory preservation period after the unit has been turned off varies depending on climate and placement of the unit. On the average, memory contents are protected over a period of a few weeks after the last time the unit has been turned off. This period is shorter when the unit is exposed to a highly humid climate.

Front panel facilities

Here is an explanation of the controls and displays on the front panel of the DTR-9.1.

Front panel

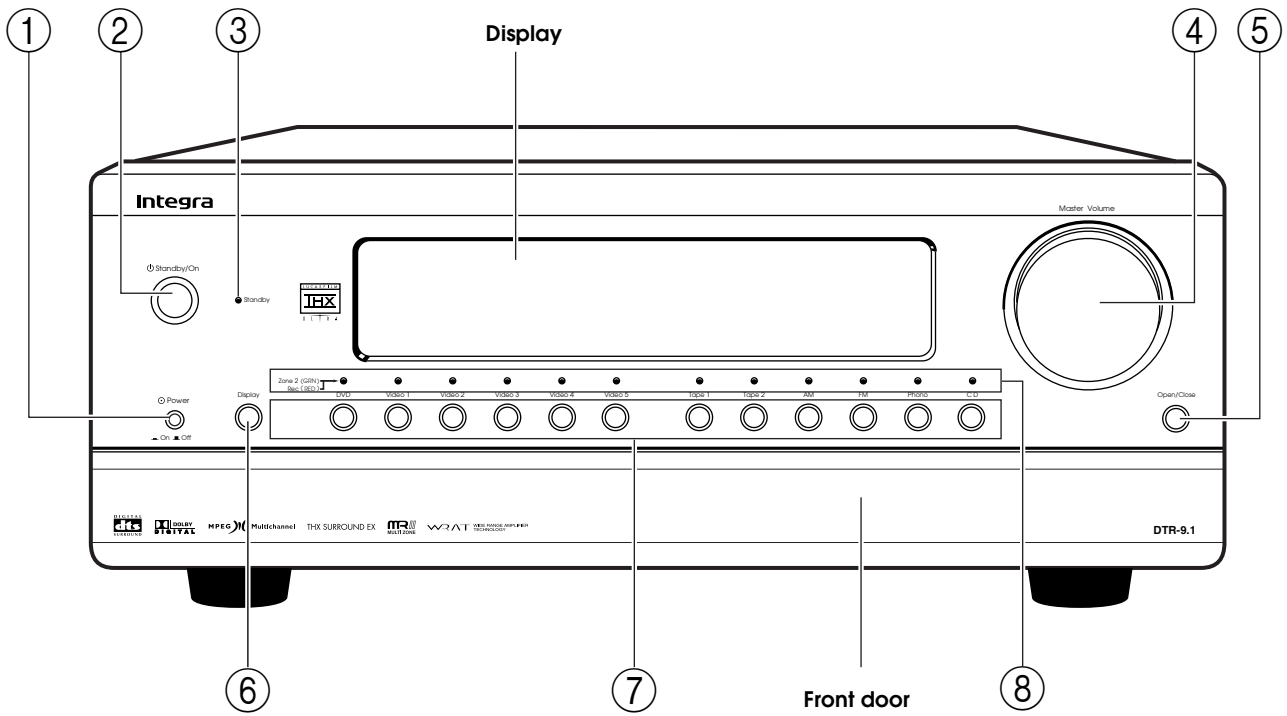

Front panel door

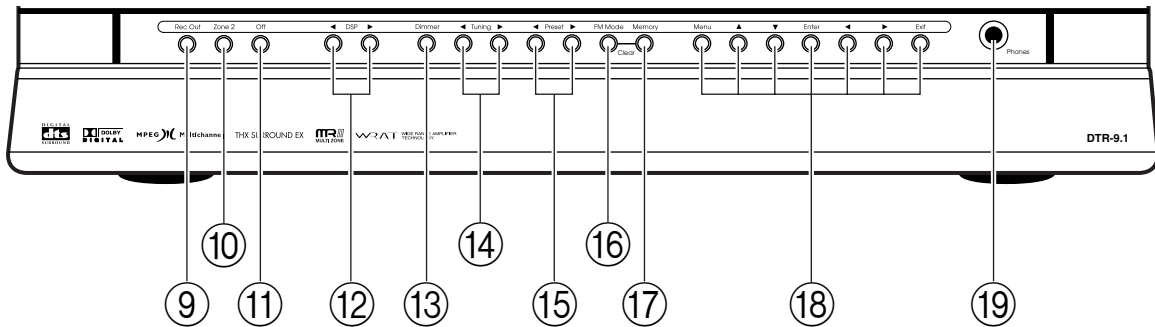

Front panel display

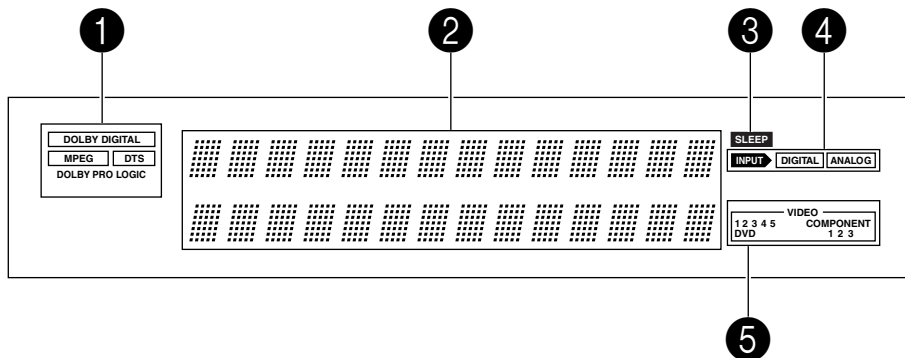

Front panel facilities

Front panel

1 Power

After plugging in the power cord into the rear panel and wall outlet, pressing this button connects the DTR-9.1 to the AC mains and turns it on.

- Before turning on the power, make sure all cables are properly connected.
- Turning on the DTR-9.1 may cause a momentary power surge that might interfere with other electrical equipment on the same circuit. If this is a problem, plug the DTR-9.1 into a different electrical circuit.

2 Standby/On

Pressing this button while the main power is turned on the STANDBY indicator lights up and the front display turns off. Pressing it again returns it to the standby state. This state turns off the display, disables control functions, and turns off all outputs to the main zone (those for the remote zone remain available).

3 Standby indicator

4 Master Volume

The MASTER VOLUME knob is used to control the volume for the main zone. The volume for the remote zone (Zone 2) is independent.

5 Open/Close

Press this button to open and close the front door that covers the lower buttons.

6 Display

The DISPLAY button is used to display information about the current input source signal. Each time you press the display button, the screen changes to show you different information concerning the input signal.

The screen changes as follows:

Program format → Sampling frequency → Digital input → Digital format → Bass level → Treble level.

If the input source signal does not have any information for a particular screen, then that screen will be skipped.

- **Displaying the data of the current input source**
Each display is explained below.

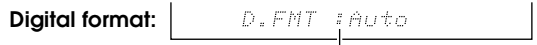
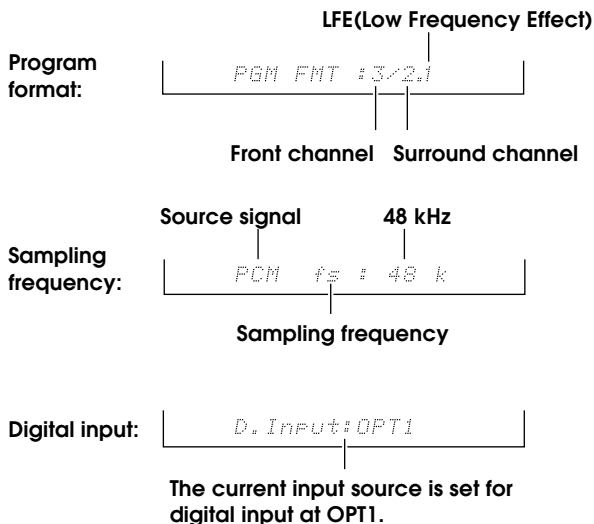

The current input source is set for a digital format of "Auto."

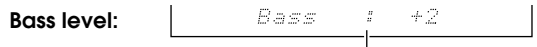

The current bass level is +2.

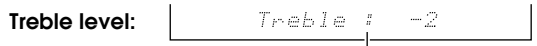

The current treble level is -2.

7 Input Source Buttons (DVD, VIDEO 1-5, TAPE 1-2, AM, FM, PHONO, and CD) and Indicator

These buttons are used to select the input source for the main zone. When an input source is selected, the indicator will light in orange. To select the input source for the remote zone (Zone 2) or recording out (Rec Out), first press the Zone 2 or Rec Out button, and then the desired input source button.

8 Zone 2/Rec Indicator

For Zone 2, the indicator above the selected input source button will light green. For recording, it will light red.

Front panel door

Caution:

The front door of the receiver is motorized. Use the open/close button to open or close the door. Manually opening or closing the door, or moving the receiver while holding the door, will cause the door to malfunction or break.

9 Rec Out

Press the Rec Out button to output to a recording component for recording purposes. After pressing the Rec Out button, press one of the input source selector buttons within 8 seconds to select the component to record to. When one is selected, the indicator above that button will light in red. To record from the same input source that you are using (that is selected for the main zone), press the Rec Out button twice in succession.

Note:

The Rec Out and Zone 2 buttons use the same circuit and therefore cannot be used at the same time. When Rec Out is selected, nothing is output from Zone 2.

10 Zone 2

The DTR-9.1 includes a second signal path separate from the main one that can be used for a remote zone (Zone 2) or for making recordings. By connecting an additional amplifier or other video equipment to the Zone 2 outputs, you can output to a separate room an input source that is different from that being used in the main room. This allows you to watch one program in one room while somebody else is watching a different program in another. Press the Zone 2 button to enable output to the ZONE 2 outputs. After pressing the Zone 2 button, press one of the input source selector buttons within 8 seconds to select the input source for the remote zone. When one is selected, the indicator above that button will light in green.

Front panel facilities

To use the same input source for the both the main and remote zones, press the Zone 2 button twice in succession.

Note:

The Rec Out and Zone 2 buttons use the same circuit and therefore cannot be used at the same time. when Zone 2 is selected, the currently selected input source is output from the recording terminal.

11 Off

When not using either Rec Out or Zone 2, press that button and then press the Off button to turn off the signal. If the Rec Out or Zone 2 signal is turned on and the connected component is not turned on, the electric signal will still be sent through the circuitry and the excess load may cause deterioration of the audio signal.

12 ◀ DSP ▶

Press these buttons to scroll through the listening modes and set a new one for the input source you are currently listening to. For each different input signal, different listening modes are possible. See page 38 for a detailed explanation of the different listening modes.

13 Dimmer

Press to set the brightness of the front display. There are 4 settings available: normal, dark, very dark, and off.

- The dimmer control for the front display can be performed at the remote controller.

14 ◀ Tuning ▶

Use these buttons to change the tuner frequency. The tuner frequency is displayed in the front display and it can be changed in 50 Hz increments for FM and 10-kHz increments for AM. When a station is tuned into, "> <" or "▶ ◀" will appear in the front display.

When FM is selected, you can hold down one of the tuning buttons and then release it to activate the auto-search feature. It will search for a station in the direction of the button you pressed and stop when it tunes into one.

15 ◀ Preset ▶

When AM or FM is selected as the input source, press one of these buttons to jump to a radio station that you preset using the MEMORY button. Pressing the right button moves from the most recently preset station to older ones, and pressing the left button moves in the reverse order.

16 FM Mode

If you are listening to an FM radio station in stereo and the sound cuts out or there is a great deal of noise, then press this button. The "MONO" display will appear and the output will change to mono. Though you will not hear the audio in stereo, this may stop the sound from cutting out and reduce excess noise.

17 Memory

This button only operates when FM or AM is selected as the input source. This button allows you to preset frequencies for stations when using the FM/AM tuner. You can preset up to 40 stations (or frequencies) to be used with the PRESET buttons.

18 Menu, ▲, ▼, Enter, ◀, ▶, Exit

These buttons are used with the On Screen Display (OSD) menu. They also perform the same functions as the OSD MENU, ▲ (upper edge of ENTER button), ▼ (lower edge of ENTER button), ◀ (left edge of ENTER button), ▶ (right edge of ENTER button), ENTER, and EXIT RETURN buttons on the remote controller.

Menu: Press to bring up the OSD menu.

Exit: Press to exit the OSD menu when at the Menu Screen, or move to one screen previous to the one that is displayed if at any other screen.

▲ and ▼: When selecting items in the OSD Menu, press these buttons to move the on-screen cursor (or the highlighted portion) upward and downward.

◀ and ▶: When setting parameters in the OSD menu, press these buttons to select parameter values or modes.

Enter: Press to display the screen for the selected item in the OSD Menu.

19 PHONES

This is a standard stereo jack for connecting stereo headphones. The audio for the front right and left speakers are sent to the headphone speakers. When the headphones are plugged in, the listening mode automatically changes to stereo and output to the speakers is stopped.

Front panel display

1 Listening mode or digital input format indicators

2 Multi function display

3 Sleep indicator

4 Input source format indicator

5 Video display

Remote controller

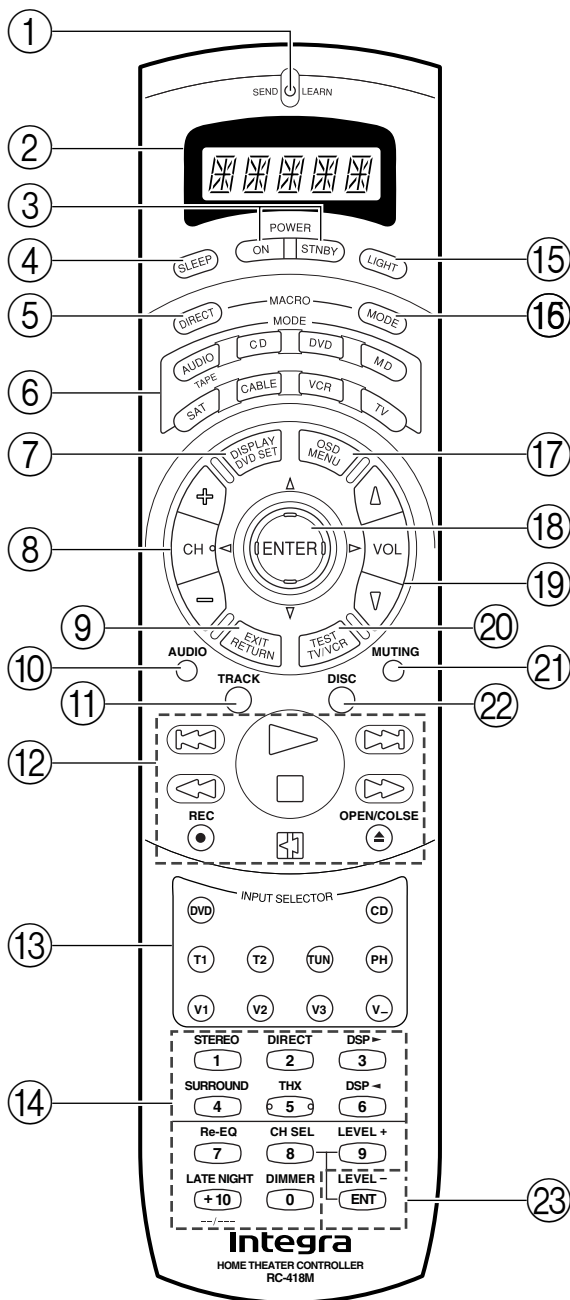

For a more detailed explanation of how to use the remote controller, refer to pages 56 through 67.

- ① **SEND/LEARN indicator**
- ② **LCD display**
- ③ **POWER ON/STNBY button**
Be aware that pressing the STNBY button only places the DTR-9.1 in standby and does not turn the power completely off.
- ④ **SLEEP button**
- ⑤ **DIRECT MACRO button**
- ⑥ **MODE buttons**
- ⑦ **DISPLAY/DVD SET button**
- ⑧ **CH +/- buttons**
- ⑨ **EXIT/RETURN button**
- ⑩ **AUDIO button**
- ⑪ **TRACK button**
- ⑫ **CD/TAPE/DVD/MD operation buttons**
- ⑬ **Input Selector buttons**
- ⑭ **Numeric key/STEREO/DIRECT/THX/DSP < > /SURROUND/Re-EQ/LATE NIGHT/CH SEL/LEVEL+,-/DIMMER buttons**
- ⑮ **LIGHT button**
- ⑯ **MODE MACRO button**
- ⑰ **OSD/MENU button**
- ⑱ **ENTER/cursor buttons**
- ⑲ **VOL Δ/∇ button**
- ⑳ **TEST/TV/VCR button**
- ㉑ **MUTING button**
- ㉒ **DISC button**
- ㉓ **ENT button**

Rear panel facilities

Here is an explanation of the terminals found on the rear of the DTR-9.1 and how they are used. Before connecting your audio and video components, be sure to read this section carefully and then proceed to the explanations on how to connect each individual component (see pages 16).

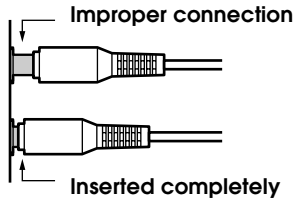

- Be sure to always refer to the instructions that came with the component that you are connecting.
- Do not plug in the power cord until all connections have been made.
- For input jacks, red connectors (marked R) are used for the right channel, white connectors (marked L) are used for the left channel, and yellow connectors (marked V) are used for video connection.
- Insert all plugs and connectors securely. Improper connections can result in noise, poor performance, or damage to the equipment.
- Do not bind audio/video connection cables with power cords and speaker cables. Doing so may adversely affect the picture and sound quality.

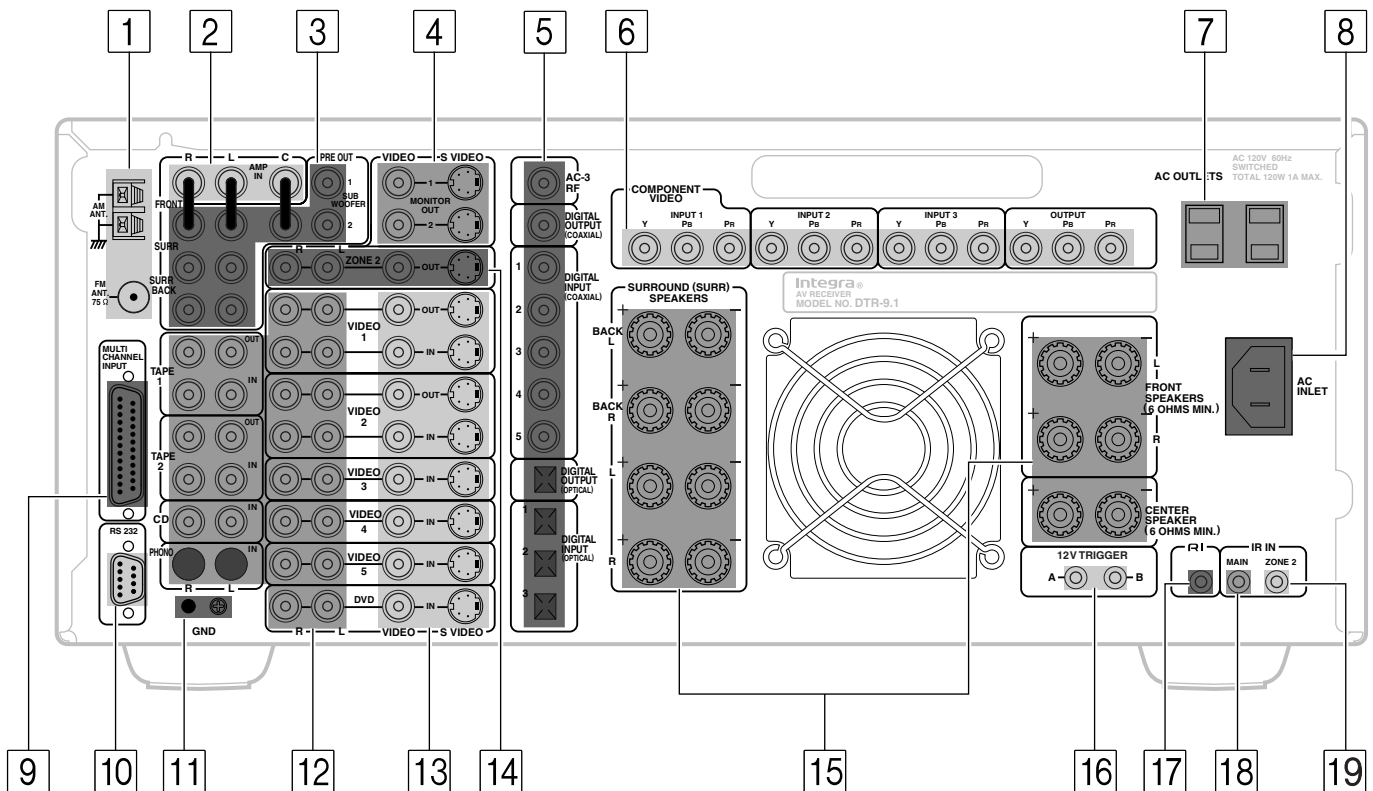

Rear panel facilities

1 ANTENNA

These jacks are for connecting the FM indoor antenna and AM loop antenna that are supplied with the DTR-9.1.

2 AMP IN

These jacks are for connecting a graphic equalizer for further control of the audio output.

- When connecting a graphic equalizer, remove the attached jumper plugs and store them carefully so as not to lose them.
- Only remove the jumper plugs when required. After you finish using an AMP IN jack, replace the jumper plug.

3 PRE OUT

These jacks are for connecting auxiliary power amplifiers.

- When connecting auxiliary power amplifiers, remove the attached jumper plugs and store them carefully so as not to lose them.
- Only remove the jumper plugs when required. After you finish using a PRE OUT jack, replace the jumper plug.

4 MONITOR OUT

There are 2 monitor outputs and each one includes both composite video and S-video configurations. When connecting two video monitors or televisions, be aware that the OSD interface can only be used with MONITOR OUT 1 (OSD will not be displayed on the video monitor connected to MONITOR OUT 2).

5 DIGITAL INPUT/OUTPUT (coaxial, optical, and input-only AC-3RF)

These are the digital audio inputs and outputs. There are 5 digital inputs with coaxial jacks, 3 with optical jacks, and 1 AC-3RF input. The inputs accept digital audio signals from a compact disc, LD, DVD, or other digital source component. For digital output, there is 1 coaxial output and 1 optical output. The digital outputs can be connected to MD recorders, CD recorders, DAT decks, or other similar components.

COAXIAL Coaxial cable

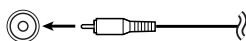

AC-3RF Coaxial cable

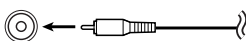

OPTICAL Optical fiber cable

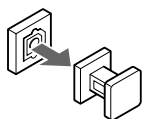

Optical digital input terminal

An optical digital input terminal is equipped with a protection cap. When connecting, remove this cap. When not using, put the cap back on the terminal.

- When using the digital inputs and outputs, make sure to also connect the analog connections whenever possible.
- When using one of the optical input or output jacks, remove the protective cap and keep it safely. When the jack is not used, replace the protective cap.
- When using an optical input or output jack, always use an optical fiber cable.

6 COMPONENT VIDEO INPUT/OUTPUT

If your DVD player or other device has component video connectors, be sure to connect them to these component video connectors on the DTR-9.1. The DTR-9.1 has three component video input connectors to obtain the color information (Y, Pb, Pr) directly from the recorded DVD signal or other video component and one component video output connector to output it directly into the matrix decoder of the display device. By sending the pure DVD component video signal directly, the DVD signal forgoes the extra processing that normally would degrade the image. The result is vastly increased image quality, with incredibly lifelike colors and crisp detail.

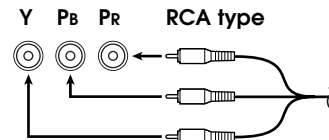

7 AC OUTLETS

The DTR-9.1 is supplied with two AC mains outlets for connecting the power cords from other devices so that their power is supplied through the DTR-9.1. By doing this, you can use the STANDBY/ON button on the DTR-9.1 to turn on and off the connected devices as well.

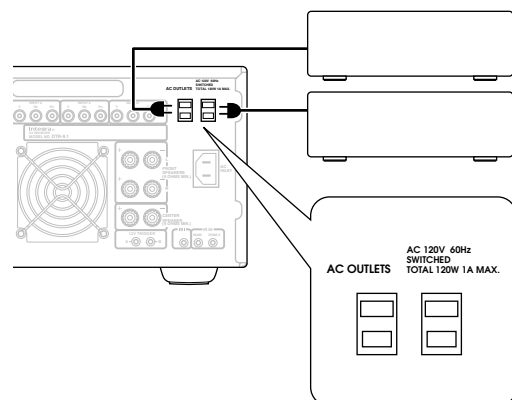

Caution

Make sure that the total capacity of the other components connected to this unit does not exceed the capacity that is printed on the rear panel. For this model, the capacity is 120 watts.

Rear panel facilities

8 AC INLET

Plug the supplied power cord into this AC INLET and then into the power outlet on the wall.

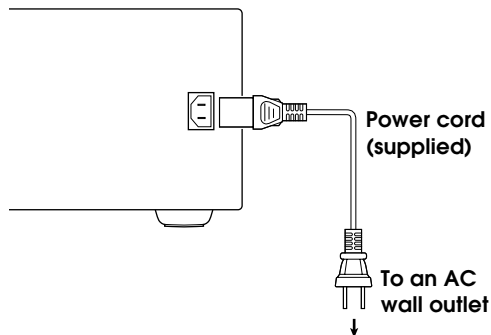

- Do not use a power cord other than the one supplied with the DTR-9.1. The power cord supplied is designed for use with the DTR-9.1 and should not be used with any other device.
- Never have the power cord disconnected from the DTR-9.1 while the other end is plugged into the wall outlet. Doing so may cause an electric shock. Always connect by plugging into the wall outlet last and disconnect by unplugging from the wall outlet first.

9 MULTI CHANNEL INPUT

By connecting a DVD player, MPEG decoder, or other component that has a multi channel port, you can playback the audio with 5.1 channel or 7.1 channel output. So, be sure to prepare a cable that can properly connect the DTR-9.1 to the peripheral device.

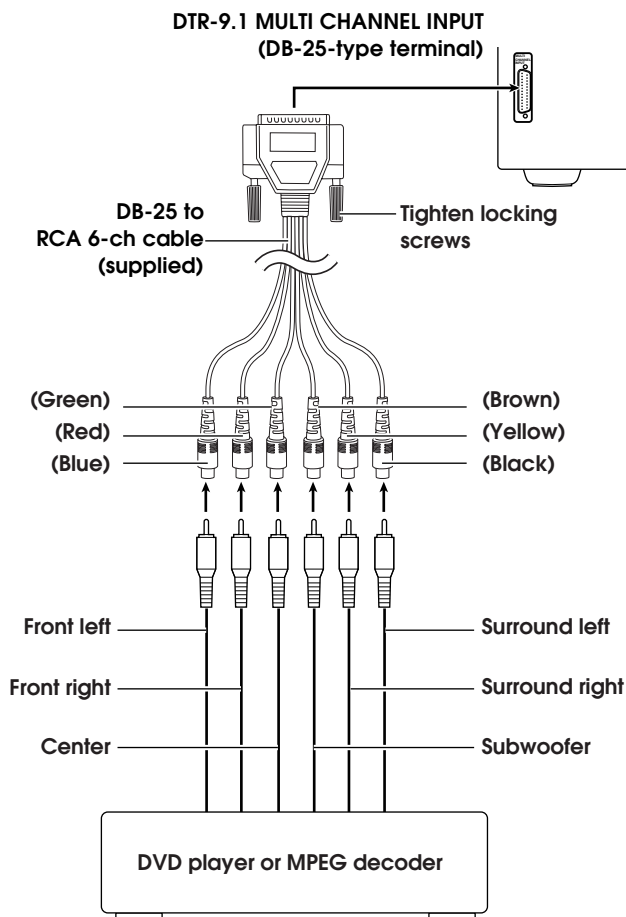

The MULTI CHANNEL INPUT is a DB-25 port and the DTR-9.1 is equipped provided with a DB-25-to-RCA 6-channel cable. When making a multi-channel connection to a DVD player or MPEG decoder, connect the DB-25 end of the cable to the MULTI CHANNEL INPUT port on the DTR-9.1 and RCA-type ends to the ends of the cables connected to the other component. The channel colors are shown below.

Front left (Blue)
Front right (Red)
Center (Green)
Surround left (Black)
Surround right (Yellow)
Subwoofer (Brown)

If the DVD player or MPEG decoder that you are connecting to is provided with DB-25-to-DB-25 cable, then connect that directly to the DTR-9.1 and do not use the cable supplied with the DTR-9.1.

When connecting the cable, be sure to secure the locking screws on the DB-25 connectors.

10 RS 232

The RS 232 port is to be used in conjunction with an external controller to control the operation of the DTR-9.1 by using an external device. The RS 232 port may also be used in the future to update the operating software of the DTR-9.1 so that it will be able to support new digital audio formats and the like as they are introduced.

11 GND

Use this GND terminal for connecting the ground (or earth) wire if a turntable is connected. Refer to "Connecting a turntable" on page 18.

12 AUDIO IN/OUT

These are the analog audio inputs and outputs. There are 10 audio inputs (6 of which are linked to video inputs) and 4 audio outputs (2 of which are linked to video outputs). The audio jacks are nominally labeled for cassette tape decks, compact disc players, turntables, and DVD players. To the audio jacks for VIDEO 1 to 5, connect the audio output from VCRs, LD players, and other video components. The audio inputs and outputs require RCA-type connectors.

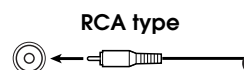

- When using the PHONO jacks, remove the caps that cover them and store them safely where they will not be lost. Whenever the PHONO jacks are not in use, replace the caps on them.
- When connecting a VCR or other video component, make sure you connect the audio and video leads together (i.e., both to VIDEO 3).
- With LD players that have an AC-3RF terminal, connect the audio source to the audio inputs of VIDEO 4 because only it supports the AC-3RF settings during digital setup.
- The DTR-9.1 is designed for use with turntables that use moving magnet cartridges.

Rear panel facilities

13 VIDEO IN/OUT

These are the video inputs and outputs. There are 6 video inputs and 2 video outputs and each one includes both composite video and S-video configurations. Connect VCRs, LD players, DVD players, and other video components to the video inputs. S-video sources can be viewed via the S-video or composite outputs, while composite sources can only be viewed through the composite output.

The 2 video output channels can be used to be connected to video tape recorders for making recordings.

Composite video jack



S video jack



- When connecting a VCR or other video component, make sure you connect the audio and video leads together (i.e., both to VIDEO 3).
- With LD players that have an AC-3RF terminal, connect the video source to the video inputs of VIDEO 4 because only it supports the AC-3RF settings during digital setup.

14 ZONE 2

These are the audio and video output jacks for the remote zone (Zone 2). Use these outputs to connect the remote zone. For the connection procedure, refer to "Setting up the remote zone" on page 24. These outputs are activated by the Zone 2 button on the front panel.

15 SPEAKERS

Seven terminals are provided for the front left, front right, front center, surround left, surround right, surround back left, and surround back right speakers. In addition to being able to reproduce the conventional 5.1-channel source input, outputs for surround back left and surround back right speakers have been added for support of the state-of-the-art THX Surround EX.

Speaker outputs are compatible with banana plug connectors.

16 12V TRIGGER

This is a 12-volt output terminal so that the DTR-9.1 can control other external devices. For other devices that have an input terminal of the same kind, you can connect it to this terminal with 1/8-inch mini-jack cable so that its power is turned on when you press an input source button. The DTR-9.1 is equipped with two 12-volt trigger terminals and each supplies a current of 100 mA. When you connect to either of these terminals, make the appropriate settings in the OSD menu.

17 RI (RI)

By connecting the **RI** connector as shown in the diagram below, you can use the RC-418M remote controller to operate Integra/Onkyo cassette tape decks and compact disc players that also have Integra/Onkyo's **RI** connectors. Simply connect a remote control cable from this connector to the **RI** connector of the cassette tape deck or compact disc player. An **RI** remote control cable with a 3.5-mm (1/8-inch) miniature two-conductor plug comes with every cassette tape deck and compact disc player that has an **RI** connector.

- For remote control operation, the audio connection cables must also be connected.
- The RC-418M remote controller does not support turntables.
- If the connected component has two RI connectors, you can use either one to connect to the DTR-9.1. The other one can be used to daisy chain with another component.
- For Integra DVD or MD players, you can control them by simply pointing the RC-418M controller directly at the component.

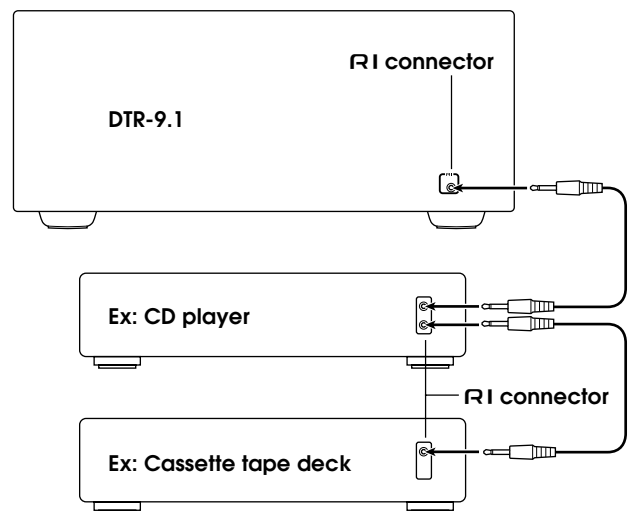

18 IR IN MAIN

If the DTR-9.1 is located inside a rack or cabinet that will not allow infrared beams to reach the IR sensor, you will need to connect a remote sensor* to this input to be able to use the remote controller. Then install the remote sensor in an unblocked location where you can easily point the remote controller.

* An optional remote sensor kit is required.

19 IR IN ZONE 2

This jack allows you to connect a multiroom system kit so that you can use the remote controller while you are in the remote zone (Zone 2), which may be far separated from the DTR-9.1.

* **To be able to use the remote controller in the remote zone (Zone 2), you must connect one of the following (sold separately):**

- Integra's Multi-Room System Kit (IR Remote Controller Extension System).
- A multiroom A/V distribution and control system from Niles®, Xantech®, or the like.

Example of how to connect your equipment

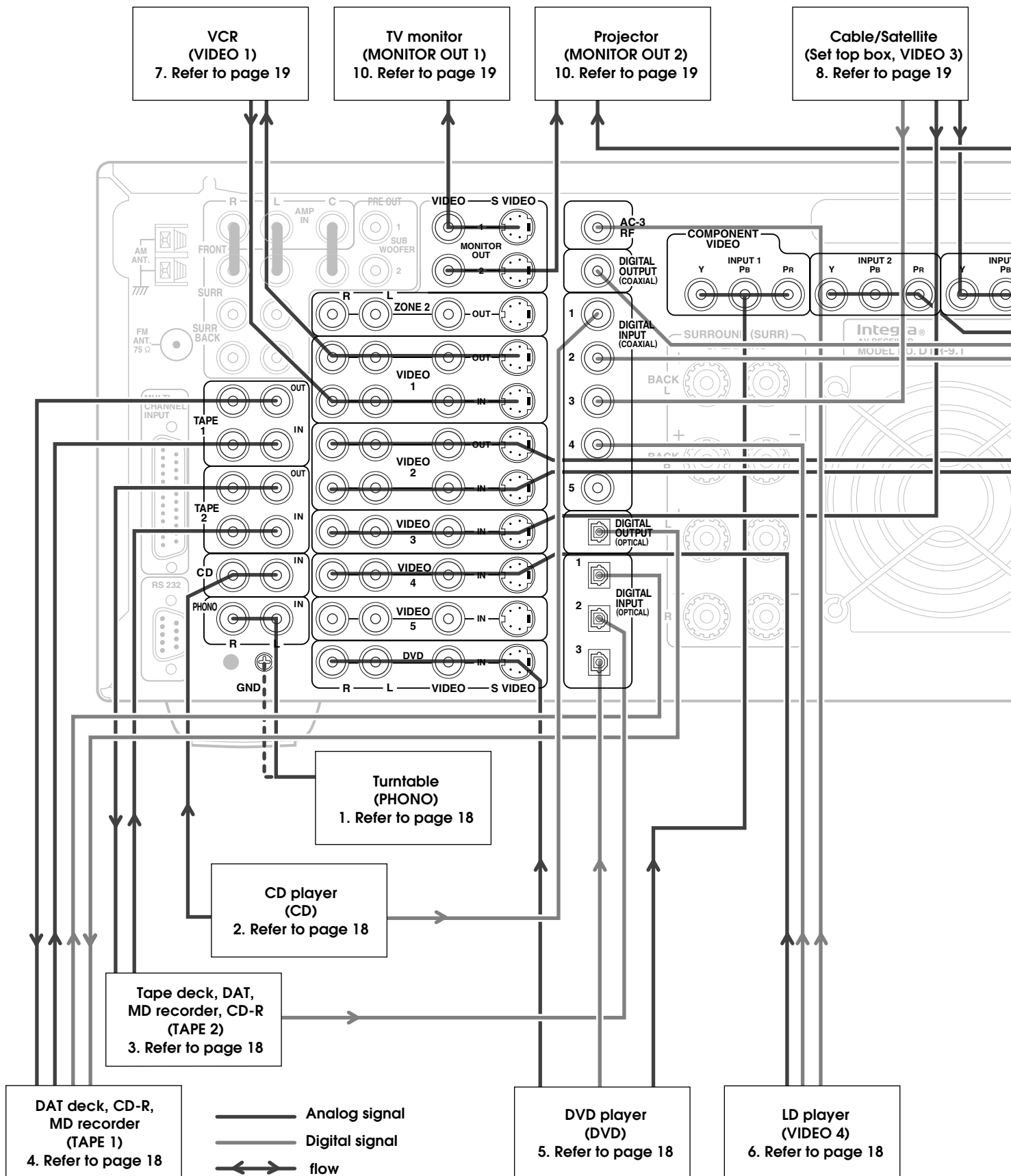

Example of how to connect your equipment

Standard connections

Here is explanation of how to connect the main components to the DTR-9.1 in the standard manner. There are many ways that any one component can be connected, and it is up to you to decide which method best fits your situation. The directions given here are only one option and should only be thought of as such. It is best to fully understand the nature of each connector and terminal as well as each of your components and their features to ascertain which method of connection is best.

- Be sure to always refer to the instruction manual that came with the component that you are connecting.
- Do not plug in the power cord until all connections have been made.
- For input jacks, red connectors (marked R) are used for the right channel, white connectors (marked L) are used for the left channel, and yellow connectors (marked V) are used for video connection.
- Insert all plugs and connectors securely. Improper connections can result in noise, poor performance, or damage to the equipment.
- Do not bind audio connection cables with power cords and speaker cables. Doing so may adversely affect the sound quality.

For a detailed explanation of how to connect the devices given below, refer to the pages listed.

Speakers: See page 20

Radio antenna: See page 22

Enjoying the DTR-9.1 from a remote room (Zone 2):

See page 24

Graphic equalizer: See page 26

Power amplifier: See page 26

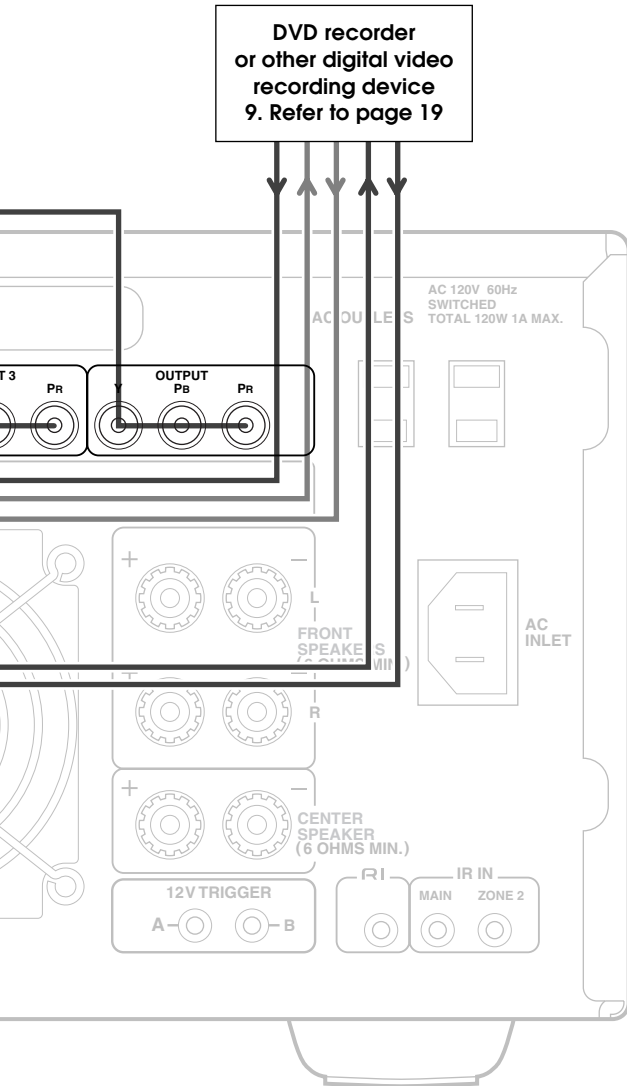

Default setting

Input source	Digital input	Component video
CD	COAXIAL 1	
PHONO		
FM		
AM		
TAPE 1	OPTICAL 1	
TAPE 2	OPTICAL 2	
DVD	OPTICAL 3	COMPONENT VIDEO 1
VIDEO 1	----	----
VIDEO 2	COAXIAL 2	COMPONENT VIDEO 2
VIDEO 3	COAXIAL 3	COMPONENT VIDEO 3
VIDEO 4	COAXIAL 4	----
VIDEO 5	COAXIAL 5	----

---- : No setting

 : No applicable

Example of how to connect your equipment

Connecting your audio components

Below is an example of how you can connect your audio components to the DTR-9.1. Refer to the diagram on pages 16 and 17 for the following connection examples.

1. Connecting a turntable

Using an RCA-type audio connection cable, connect the output terminal on the turntable to the PHONO IN jacks on the DTR-9.1. Make sure that you properly connect the left channel to the L jack and the right channel to the R jack.

Note:

The DTR-9.1 is designed for use with moving magnet cartridges. For proper operation, connect a ground (or earth) wire to the GND terminal. For some turntables, however, connecting the ground wire may cause increased noise, and in such a case, a ground wire is not necessary and should not be connected.

2. Connecting a compact disc player

Using an RCA-type audio connection cable, connect the output terminal on the compact disc player to the CD IN jacks on the DTR-9.1. Make sure that you properly connect the left channel to the L jack and the right channel to the R jack.

If the compact disc player has a digital output jack as well, be sure to also connect it to either a DIGITAL INPUT (COAXIAL) or DIGITAL INPUT (OPTICAL) jack on the DTR-9.1 depending on the type of connector on the compact disc player.

With the initial settings of the DTR-9.1, the CD input source is set for digital input at the COAXIAL 1 jack. If the digital connection is made at a different jack, this must be changed at the OSD Menu: Input Setup → Digital Setup → Digital Input (see page 34).

3. Connecting a cassette tape deck, MD recorder, DAT deck, or CD recorder

Using an RCA-type audio connection cable, connect the output terminals (PLAY) of the device to the TAPE 2 IN jacks on the DTR-9.1 and the input terminals (REC) to the TAPE 2 OUT jacks. Make sure that you properly connect the left channel to the L jack and the right channel to the R jack.

If the device has a digital output jack as well, be sure to also connect it to either a DIGITAL INPUT (COAXIAL) or DIGITAL INPUT (OPTICAL) jack on the DTR-9.1 depending on the type of connector on the device.

With the initial settings of the DTR-9.1, the TAPE 2 input source is set for digital input at the OPTICAL 2 jack. If the digital connection is made at a different jack, this must be changed at the OSD Menu: Input Setup → Digital Setup → Digital Input (see page 34).

If the device also has a digital input jack, it can be connected to the DIGITAL OUTPUT (COAXIAL) or DIGITAL OUTPUT (OPTICAL) jack on the DTR-9.1 for recording of the signal from the input source selected at the DTR-9.1.

4. Connecting an MD recorder, DAT deck, or CD recorder

Using an RCA-type audio connection cable, connect the output terminals (PLAY) of the device to the TAPE 1 IN jacks on the DTR-9.1 and the input terminals (REC) to the TAPE 1 OUT jacks. Make sure that you properly connect the left channel to the L jack and the right channel to the R jack.

If the device has a digital output jack as well, be sure to also connect it to either a DIGITAL INPUT (COAXIAL) or DIGITAL INPUT (OPTICAL) jack on the DTR-9.1 depending on the type of connector on the device.

With the initial settings of the DTR-9.1, the TAPE 1 input source is set for digital input at the OPTICAL 1 jack. If the digital connection is made at a different jack, this must be changed at the OSD Menu: Input Setup → Digital Setup → Digital Input (see page 34).

If the device also has a digital input jack, it can be connected to the DIGITAL OUTPUT (COAXIAL) or DIGITAL OUTPUT (OPTICAL) jack on the DTR-9.1 for recording of the signal from the input source selected at the DTR-9.1.

Connecting your video components

Below is an example of how you can connect your video components to the DTR-9.1. Refer to the diagram on pages 16 and 17 for the following connection examples.

The flow of the video signals is as follows: the signal that comes in from VIDEO IN is sent to VIDEO OUT, the signal that comes in from S-VIDEO IN is sent to S-VIDEO OUT and VIDEO OUT, and the signal that comes in from COMPONENT VIDEO IN is sent to COMPONENT VIDEO OUT.

If only the video connection for the MONITOR OUT is made, even if the input from each source component is through a component video connection, the picture will not appear. If only the S-video connection for the MONITOR OUT is made, the picture will not appear.

5. Connecting a DVD player

Using an RCA-type video connection cable, connect the video output terminal (composite) on the DVD player to the DVD VIDEO IN jack on the DTR-9.1. If there is an S-video output terminal on the DVD player, connect it to the DVD S VIDEO IN jack using an S-video cable. If the DVD player has component video outputs, connect them to one of the COMPONENT VIDEO INPUT jacks.

Using an RCA-type audio connection cable, connect the audio output terminal on the DVD player to the audio DVD IN jacks on the DTR-9.1. Make sure that you properly connect the left channel to the L jack and the right channel to the R jack.

If the DVD player has a digital output jack as well, be sure to also connect it to either a DIGITAL INPUT (COAXIAL) or DIGITAL INPUT (OPTICAL) jack on the DTR-9.1 depending on the type of connector on the DVD player.

With the initial settings of the DTR-9.1, the DVD input source is set for digital input at the OPTICAL 3 jack. If the digital connection is made at a different jack, this must be changed at the OSD Menu: Input Setup → Digital Setup → Digital Input (see page 34).

Example of how to connect your equipment

6. Connecting a LD player

Using an RCA-type video connection cable, connect the video output terminal (composite) on the LD player to the VIDEO 4 IN jack on the DTR-9.1. If there is an S-video output terminal on the LD player, connect it to the S VIDEO 4 IN jack using an S-video cable.

If the LD player has an AC-3RF output, connect it to the AC-3RF jack on the DTR-9.1. If this connection is made, "AC-3RF" must be set in the OSD Menu: Input Setup → Digital Setup → Digital Format (see page 34).

Using an RCA-type audio connection cable, connect the audio output terminal on the LD player to the audio VIDEO 4 IN jacks on the DTR-9.1. Make sure that you properly connect the left channel to the L jack and the right channel to the R jack.

If the LD player has a digital output jack as well, be sure to also connect it to either a DIGITAL INPUT (COAXIAL) or DIGITAL INPUT (OPTICAL) jack on the DTR-9.1 depending on the type of connector on the LD player.

With the initial settings of the DTR-9.1, the VIDEO 4 input source is set for digital input at the COAXIAL 4 jack. If the digital connection is made at a different jack, this must be changed at the OSD Menu: Input Setup → Digital Setup → Digital Input (see page 34).

7. Connecting a video cassette recorder

Using an RCA-type video connection cable, connect the video output terminal (composite) on the video cassette recorder to the VIDEO 1 IN jacks on the DTR-9.1 and video input terminal to the VIDEO 1 OUT jacks. If there is an S-video input/output terminal on the video cassette recorder, connect it to the S VIDEO 1 IN/OUT jack using an S-video cable. If the video cassette recorder has component video outputs, connect them to one of the COMPONENT VIDEO INPUT jacks.

Using an RCA-type audio connection cable, connect the audio output terminal on the video cassette recorder to the same VIDEO 1 IN audio jacks on the DTR-9.1 and audio input terminal to the VIDEO 1 OUT audio jacks. Make sure that you properly connect the left channel to the L jack and the right channel to the R jack.

8. Connecting a satellite tuner or television

Using an RCA-type video connection cable, connect the video output terminal (composite) on the satellite tuner or television to the VIDEO 3 IN jacks on the DTR-9.1. If there is an S-video output terminal on the satellite tuner or television, connect it to the S VIDEO 3 IN jack using an S-video cable. If the satellite tuner or television has component video outputs, connect them to one of the COMPONENT VIDEO INPUT jacks.

Using an RCA-type audio connection cable, connect the audio output terminal on the satellite tuner or television to the same VIDEO 3 IN audio jacks on the DTR-9.1. Make sure that you properly connect the left channel to the L jack and the right channel to the R jack.

If the satellite tuner or television has a digital output jack as well, be sure to also connect it to either a DIGITAL INPUT (COAXIAL) or DIGITAL INPUT (OPTICAL) jack on the DTR-9.1 depending on the type of connector on the set top box or television.

With the initial settings of the DTR-9.1, the VIDEO 3 input source is set for digital input at the COAXIAL 3 jack. If the digital connection is made at a jack different from the initial settings, this must be changed at the OSD Menu: Input Setup → Digital Setup → Digital Input (see page 34).

9. Connecting a DVD recorder or other digital video recording device

Using an RCA-type video connection cable, connect the video output terminal (composite) on the device to the VIDEO 2 IN jacks on the DTR-9.1 and video input terminal to the VIDEO 1 OUT jacks. If there is an S-video input/output terminal on the device, connect it to the S VIDEO 2 IN/OUT jack using an S-video cable. If the device has component video outputs, connect them to one of the COMPONENT VIDEO INPUT jacks.

Using an RCA-type audio connection cable, connect the audio output terminal on the device to the same VIDEO 2 IN audio jacks on the DTR-9.1 and audio input terminal to the VIDEO 1 OUT audio jacks. Make sure that you properly connect the left channel to the L jack and the right channel to the R jack.

If the device has a digital output jack as well, be sure to also connect it to either a DIGITAL INPUT (COAXIAL) or DIGITAL INPUT (OPTICAL) jack on the DTR-9.1 depending on the type of connector on the device.

With the initial settings of the DTR-9.1, the VIDEO 2 input source is set for digital input at the COAXIAL 2 jack. If the digital connection is made at a jack different from the initial settings, this must be changed at the OSD Menu: Input Setup → Digital Setup → Digital Input (see page 34).

If the device also has a digital input jack, it can be connected to the DIGITAL OUTPUT (COAXIAL) or DIGITAL OUTPUT (OPTICAL) jack on the DTR-9.1 for recording of the signal from the input source selected at the DTR-9.1.

10. Connecting a television monitor or projector

Using an RCA-type video connection cable, connect the video input terminal (composite) on the monitor to one of the MONITOR OUT jacks on the DTR-9.1. If there is an S-video input terminal on the monitor, connect it to the S VIDEO MONITOR OUT jack using an S-video cable. If the device has component video inputs, connect them to the COMPONENT VIDEO OUTPUT jacks.

Note that the OSD Menu will not be displayed on the monitor connected to MONITOR OUT 2. This allows you to connect large screens or projectors to MONITOR OUT 2 and use a smaller television connected to MONITOR OUT 1 just to make settings in the OSD Menu.

Connecting speakers

Before connecting the speakers, place them correctly by consulting the instruction manuals that came with them.

For surround playback, the configuration and placement of your speakers are very important.

For THX surround EX playback, we recommend that you use a THX speaker system that is certified by Lucasfilm Ltd.

Ideal speaker configuration

- **Front right and left speakers**
- **Center speaker**
Produces a rich sound image by serving as a sound source for the front right and left speakers and enhancing the sonic movement.
- **Surround right and left speakers**
Adds three-dimensional sonic movement and produces environmental sound associated with the background and effect sound for each scene.
- **Surround back right and left speakers**
Required for enjoying THX Surround EX audio.
- **Subwoofer**
Produces powerful and heavy bass.

Minimum speaker configuration for surround sound playback

- **Front right and left speakers**
- **Surround right and left speakers**

The sound recorded for the center speaker and the subwoofer will be properly distributed to the front right and left speakers and the surround right and left speakers for optimized surround playback.

Speaker placement

Ideal speaker placement varies depending on the size of your room and the wall coverings. Here, only typical example of speaker placement and recommendations are shown.

Important points regarding speaker placement

Front left and right speakers and center speaker

- Place these three speakers at the same height from the floor.
- Place each speaker so that sound is aimed at the location of the listener's ears when at the listening position.

Surround left and right speakers

- Place these speakers so that their height is 1 meter higher than that of the listener's ears.

Surround back left and right speakers

- These speakers are required for enjoying THX Surround EX audio.
- Place these speakers behind the listener so that the angle between each speaker and the listener is approximately 30 degrees.
- Place these speakers so that their height is 1 meter higher than that of the listener's ears.

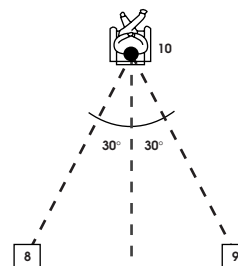

Subwoofer

A subwoofer is recommended for the highest bass effect.

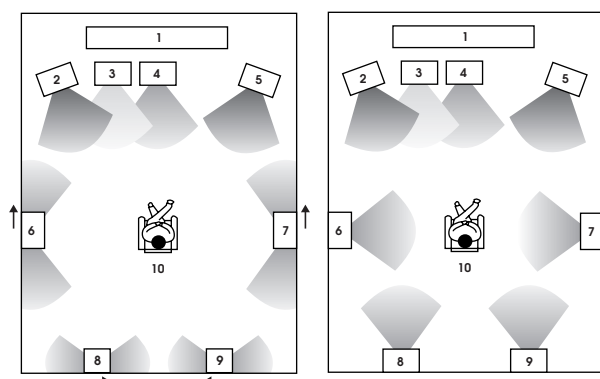

- | | |
|-----------------------|-------------------------------|
| 1 TV or screen | 6 Surround left speaker |
| 2 Front left speaker | 7 Surround right speaker |
| 3 Subwoofer | 8 Surround back left speaker |
| 4 Center speaker | 9 Surround back right speaker |
| 5 Front right speaker | 10 Listening position |

Most dipoles have an arrow on them to indicate their orientation towards the screen. So for the side dipoles, the arrows point forward. For the back dipoles, the arrows should point towards each other to achieve the correct acoustical phasing in the room.

Connecting speakers

Connecting speakers

Notes:

- The DTR-9.1 is designed to produce optimum sound quality when speakers with impedances within the specified ranges are connected. Check the following information and choose speakers with appropriate impedances for the connections.

CAUTION:

SPEAKER IMPEDANCE

6 min. per each speaker terminal.

- When you are using only one speaker or when you wish to listen to monaural (mono) sound, a single speaker should never be connected in parallel to both the right and left-channel terminals simultaneously.

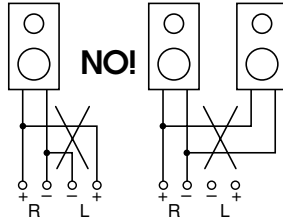

- To prevent damage to circuitry, never short-circuit the positive (+) and negative (-) speaker wire.



Connecting the speaker cable

- Strip away 5/8" of wire insulation.
- Twist wire ends very tight.
- Unscrew
- Insert wire
- Screw

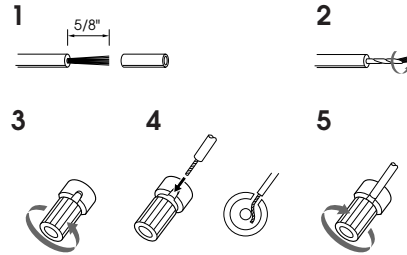

Connecting a subwoofer

Use the PRE OUT SUBWOOFER jack to connect a subwoofer with a built-in power amplifier. If your subwoofer does not have a built-in amplifier, connect an amplifier to the PRE OUT SUBWOOFER jack and the subwoofer to the amplifier. The output to PRE OUT SUBWOOFER 1 and PRE OUT SUBWOOFER 2 is the same.

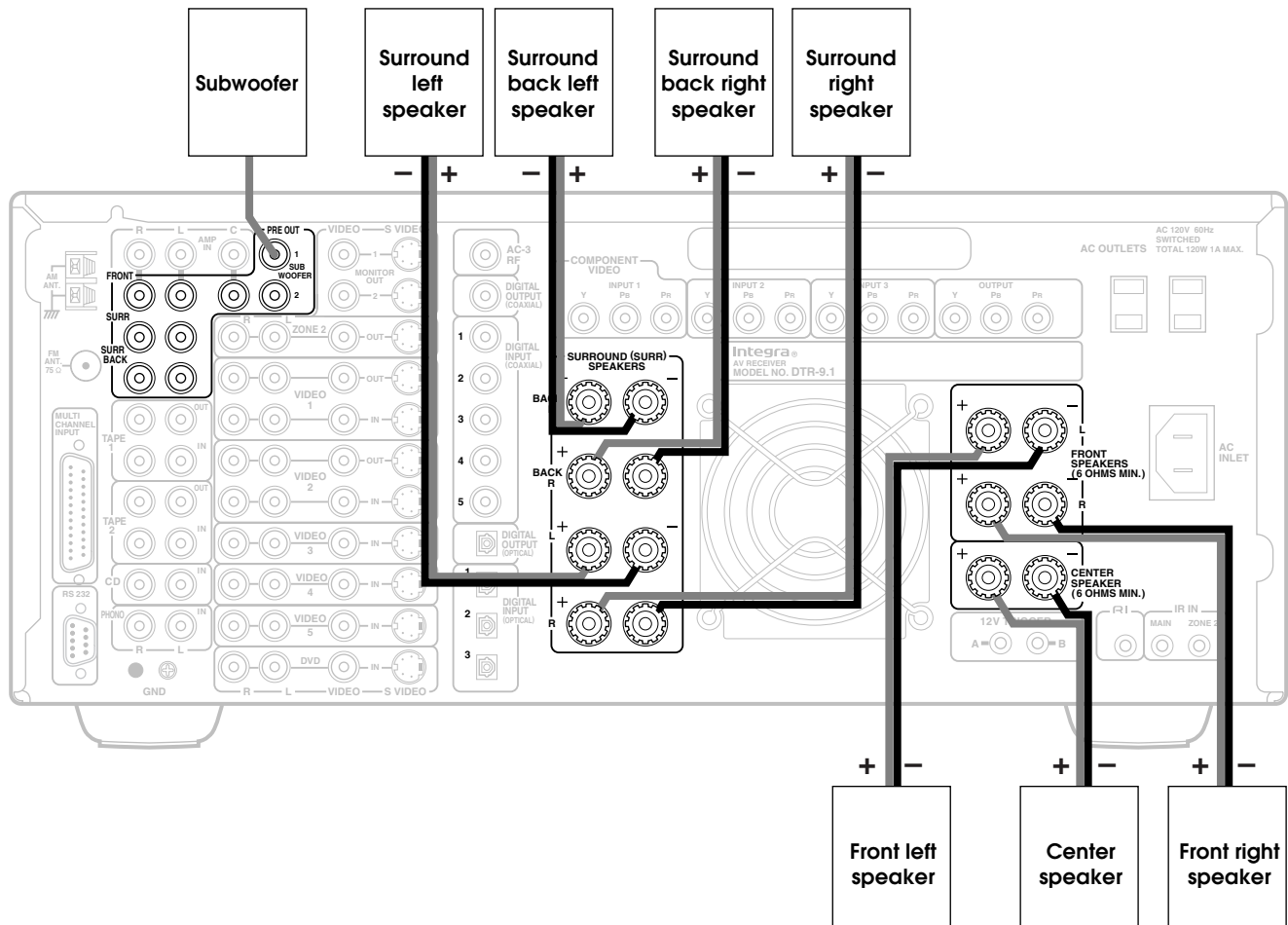

Connecting antennas

Connecting the included antennas

Connecting the FM indoor antenna:

The FM indoor antenna is for indoor use only. During use, extend the antenna and move it in various directions until the clearest signal is received. Fix it with push pins or similar implements in the position that will cause the least amount of distortion.

If the reception is not very clear with the attached FM indoor antenna, the use of an outdoor antenna is recommended.

Connecting the AM loop antenna:

The AM loop antenna is for indoor use only. Set it in the direction and position where you receive the clearest sound. Put it as far away as possible from the DTR-9.1, televisions, speaker cables, and power cords.

When reception is not satisfactory with the attached AM loop antenna alone, connection of an outdoor antenna is recommended.

Assembling the AM loop antenna

Assemble the loop antenna as shown in the illustration.

- Refer to the next page for details on connecting the AM loop antenna.

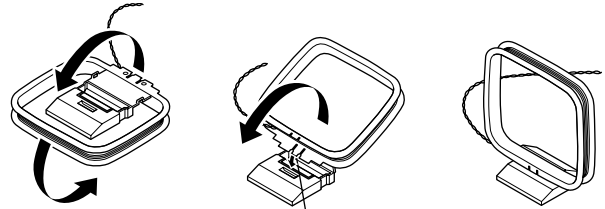

Insert into the hole.

Connecting the AM antenna cable

1. Press down the lever.
2. Insert the wire into the hole.
3. Release the lever.

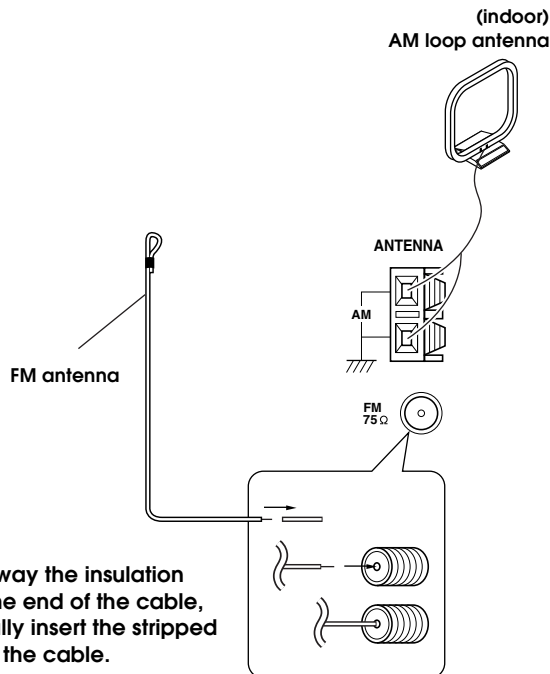
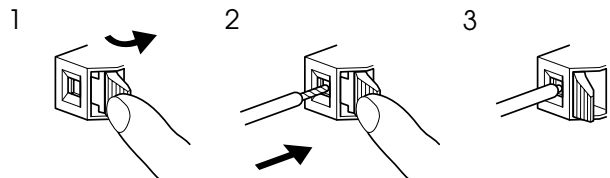

Connecting antennas

Connecting an FM outdoor antenna

Please make sure that you follow the considerations:

- Keep the antenna away from noise sources (neon signs, busy roads, etc.).
- It is dangerous to put the antenna close to power lines. Keep it well away from power lines, transformers, etc.
- To avoid the risk of lightning and electrical shock, grounding is necessary. Follow item 14 of the "Important Safeguards" on page 2 when you install the outdoor antenna.

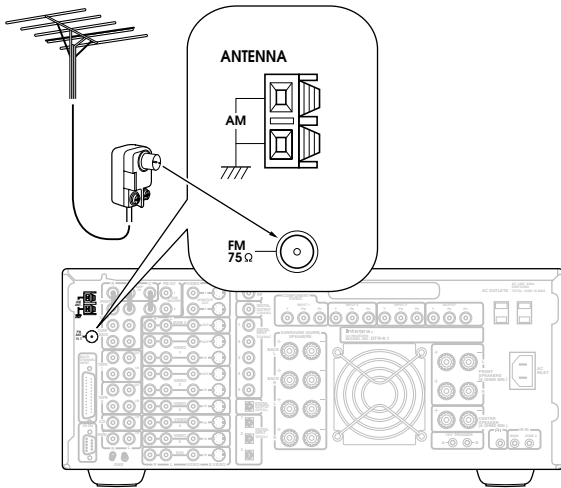

Directional linkage

Do not use the same antenna for both FM and TV (or VCR) reception since the FM and TV (or VCR) signals can interfere with each other. If you must use a common FM/TV (or VCR) antenna, use a directional linkage type splitter.

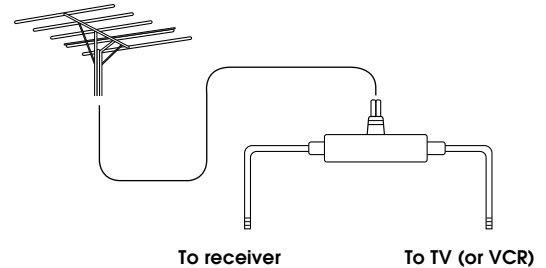

Connecting an AM outdoor antenna

An outdoor antenna will be more effective if it is stretched horizontally above a window or outside.

- Do not remove the AM loop antenna.
- To avoid the risk of lightning and electrical shock, grounding is necessary. Follow item 14 of the "Important Safeguards" on page 2 when you install the outdoor antenna.

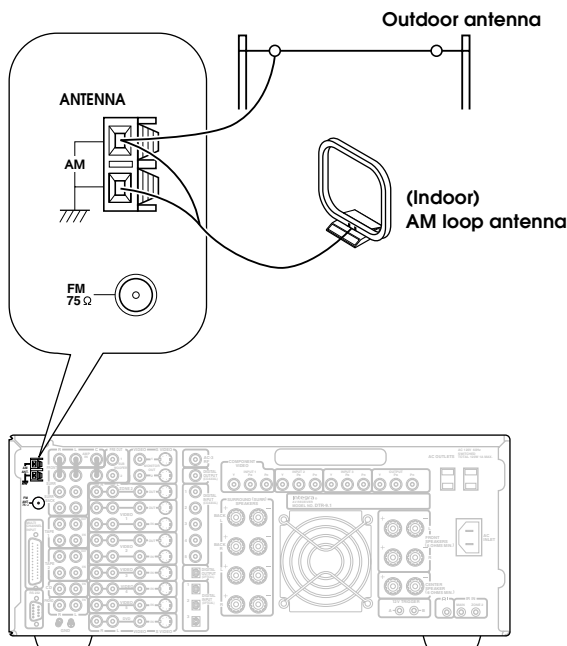

Connecting to the IR IN ZONE 2 input

Outline

The IR IN ZONE 2 input allows you to control the DTR-9.1 from the remote zone (Zone 2) with the remote controller even though the remote zone is physically separated. The diagram below shows how to make the proper connections for the remote zone.

The following equipment (sold separately) is essential for operation from the remote zone:

- Onkyo's Multi-Room System kits (IR Remote Controller Extension System), or
- Multiroom A/V distribution and control systems from Nilés® and Xantech® to name a few

Make connection as shown below. Do not plug the equipment into the power source until the connection is complete.

Connecting the main and remote zones

The ZONE 2 terminal is a constant output. Connect to the LINE input of the amplifier (CD, tape, etc.). Adjust the volume with the amplifier connected to the ZONE 2 terminal.

1. Connect the DTR-9.1 to the amplifier for the remote zone.
2. Connect the remote zone speaker cables to the speaker terminals on the amplifier.
3. Connect the DTR-9.1 to the monitor for the remote zone.
4. Install the connecting block in the main zone and connect it to the IR IN ZONE 2 input at the DTR-9.1.
5. Install the remote sensor in the remote zone and connect it to the connecting block in the main zone.

Connection example for Onkyo's Multi-room System kit

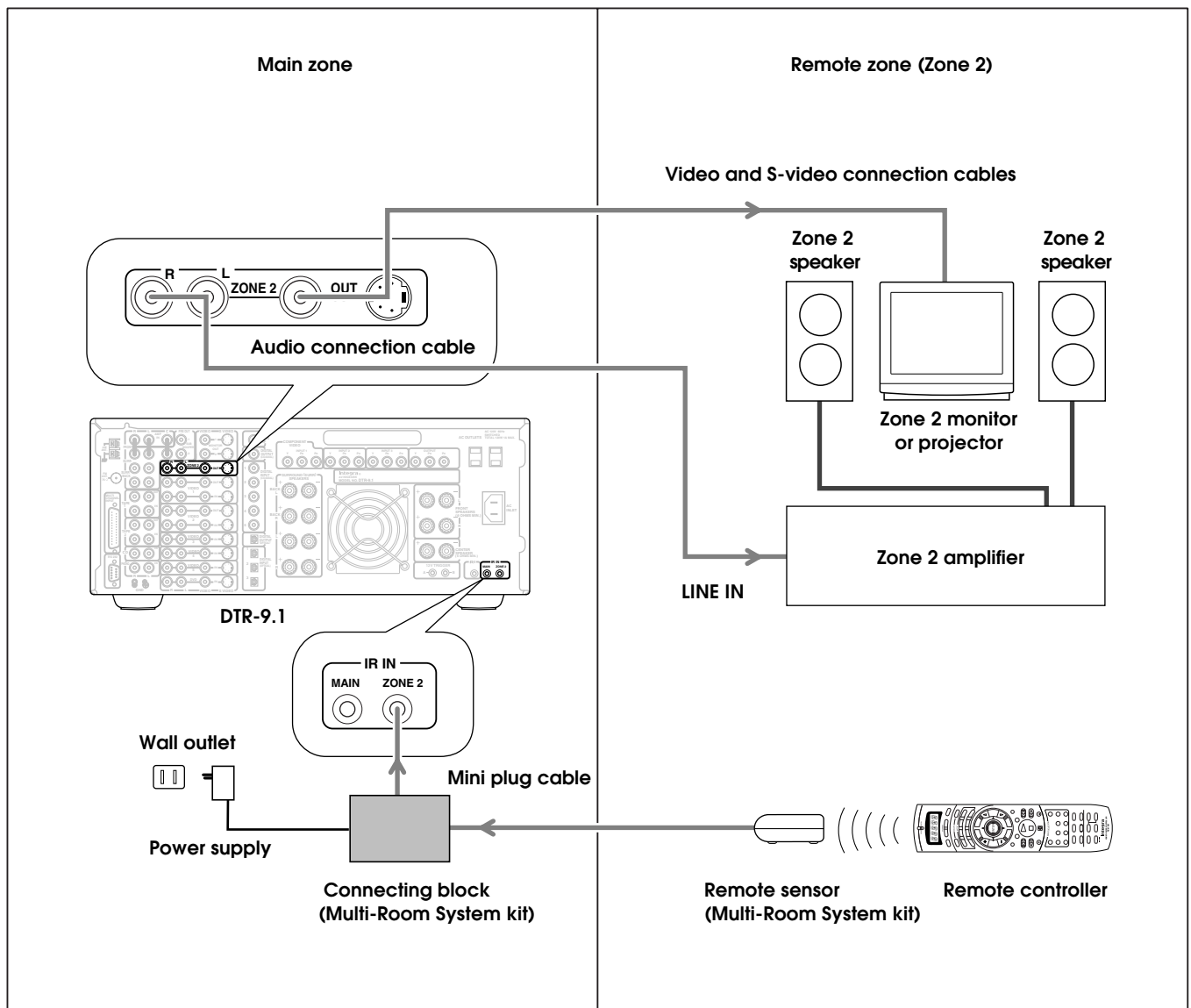

Connecting to the IR IN MAIN input

Outline

If the DTR-9.1 is located inside a cabinet or other enclosure where the infrared beams from the remote controller cannot enter, then operation with the remote controller will not be possible. In such a case, it will be necessary to install a remote sensor at a location outside of the cabinet for the infrared beams from the controller to reach.

1. Connect the connecting block to the IR IN MAIN input at the DTR-9.1.
2. Install the remote sensor at a location where it can detect the infrared beams from the remote controller.
3. Connect the remote sensor to the connecting block.

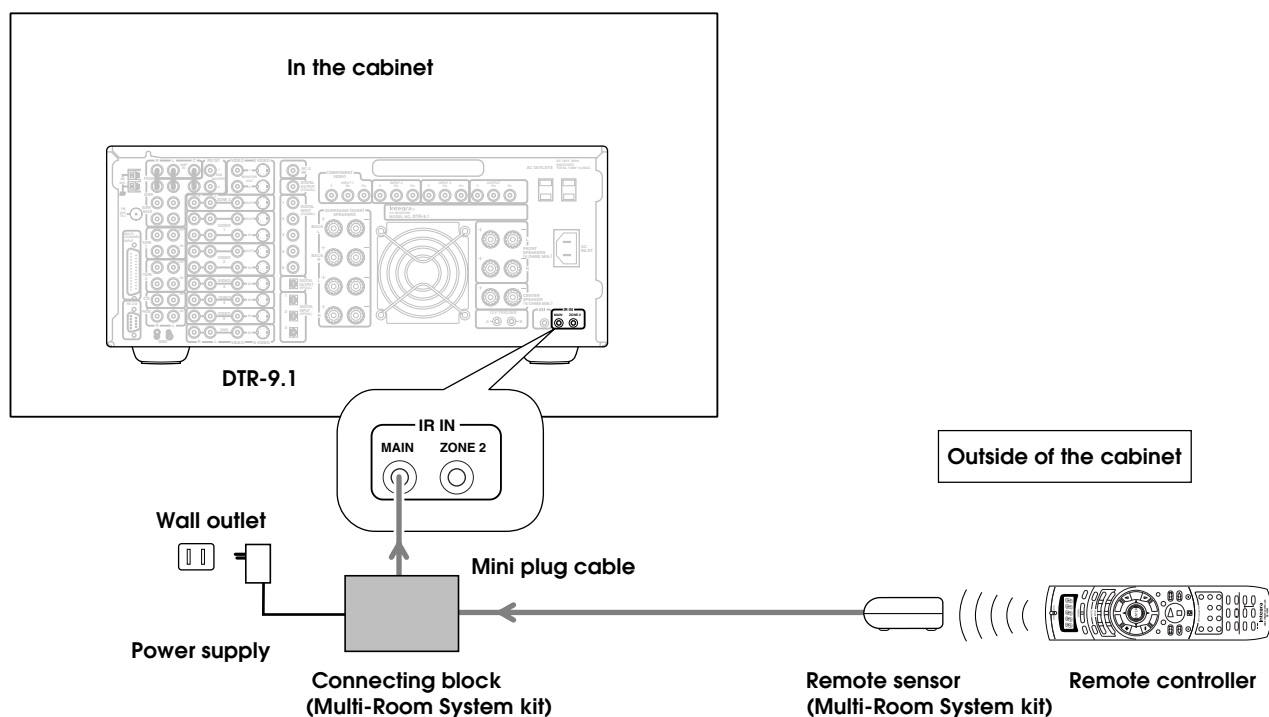

Connecting a graphic equalizer and power amplifiers

Connecting a graphic equalizer

The AMP IN and the PREOUT connectors are attached with jumper plugs. When connecting a graphic equalizer, remove these jumper plugs before connecting the audio connection cables.

1. Remove the jumper plugs.

2. Connect a graphic equalizer.

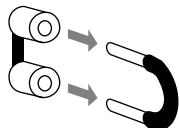

Notes:

- Keep the jumper plugs so that you will not lose them.
- When the connectors are not in use, replace the jumper plugs.

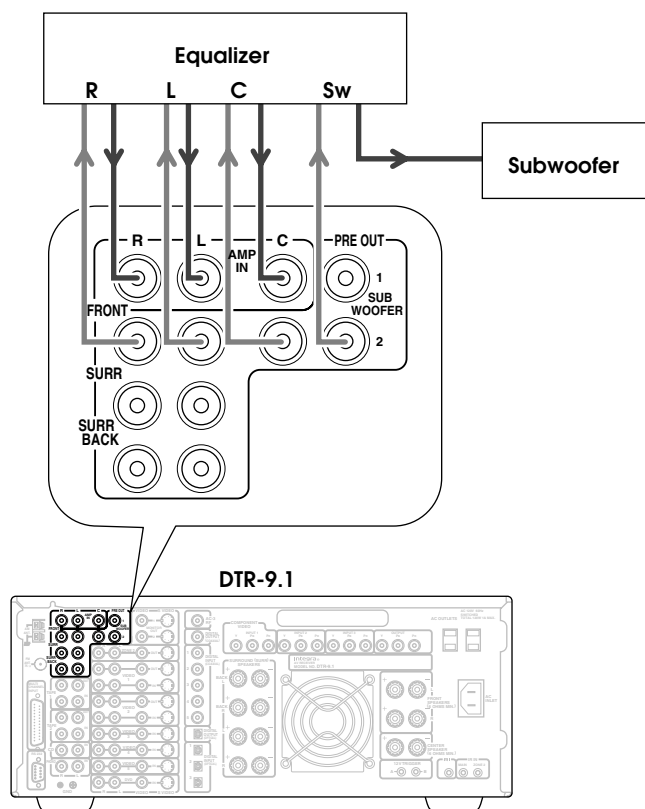

Connecting power amplifiers

Using auxiliary power amplifiers allows you to listen at louder volumes than with the DTR-9.1 alone. If power amplifiers are used, connect each speaker to the corresponding power amplifier.

1. Remove the jumper plugs.

2. Connect the power amplifiers.

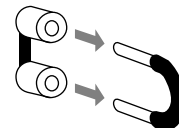

Notes:

- Keep the jumper plugs so that you will not lose them.
- When the connectors are not in use, replace the jumper plugs.

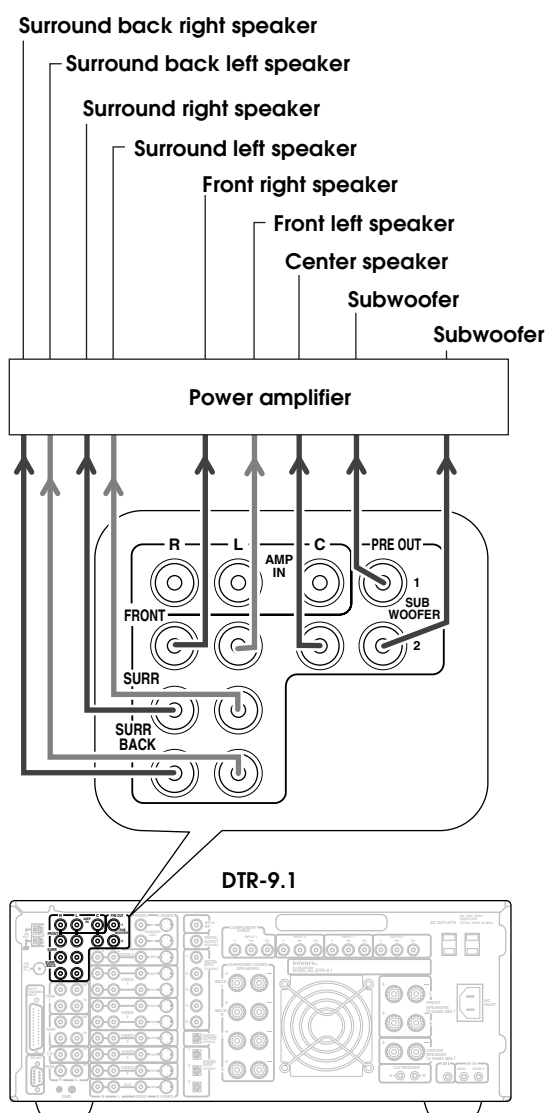

Connecting the power

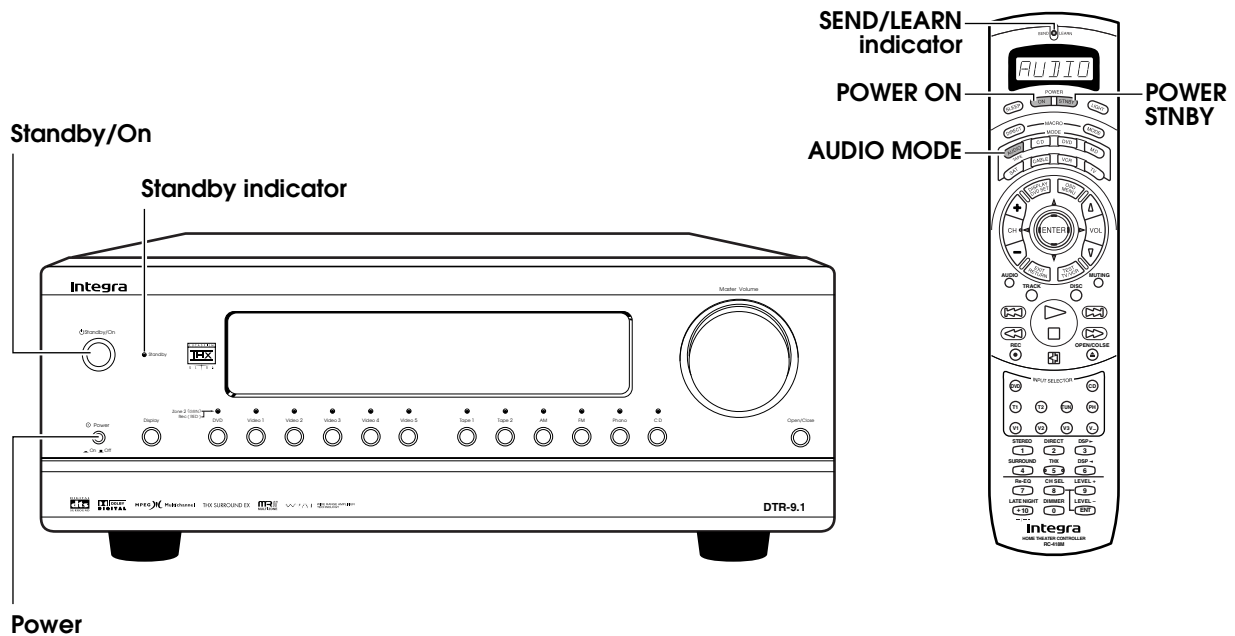

Connecting the power

- The DTR-9.1 is shipped with the main power (POWER) switch in the on position (ON). When the power cord is plugged in for the first time, the DTR-9.1 will automatically enter the standby state and the STANDBY indicator will light (same condition after step 2 below).
- Before you plug in the DTR-9.1, confirm that all connections have been made properly.
- Turning on the power may cause a momentary power surge, which might interfere with other electrical equipment on the same circuit, such as computers. If this happens, use a wall outlet on a different circuit.

1. Plug the power cord into an AC wall outlet.
2. Press the POWER switch to set the DTR-9.1 to standby state.
The STANDBY indicator will light up.
3. Press the STANDBY/ON button to turn on the DTR-9.1. The display will light up and the STANDBY indicator will turn off.

Display

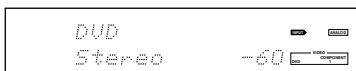

If you press the STANDBY/ON button again, the receiver returns to Standby mode.

Turning the power on from the remote controller:

Before you can use the remote controller, you must perform steps 1 and 2 above and place the DTR-9.1 in the standby state.

1. Press the AUDIO MODE button.
2. Press the POWER ON button to turn on the DTR-9.1 (take it out of the standby state).
 - To return the DTR-9.1 to the standby state, press the POWER STNBY button.

The On-Screen Display (OSD) menu

The OSD menu is a settings menu that is displayed on your TV monitor and allows you to perform your speaker settings, setup your input sources, set the listening modes, and much more. In most situations, you will only need to set this once during the installation and layout of your home theater, and it rarely needs to be changed later.

The OSD menu consists of a main screen that is divided up into six menus: Speaker Setup, Input Setup, Listening Mode Setup, Preference, Zone2 OSD Setup, and About. These menus are then divided up into various sub-menus, and these contain settings for you to optimize your home theater as you wish.

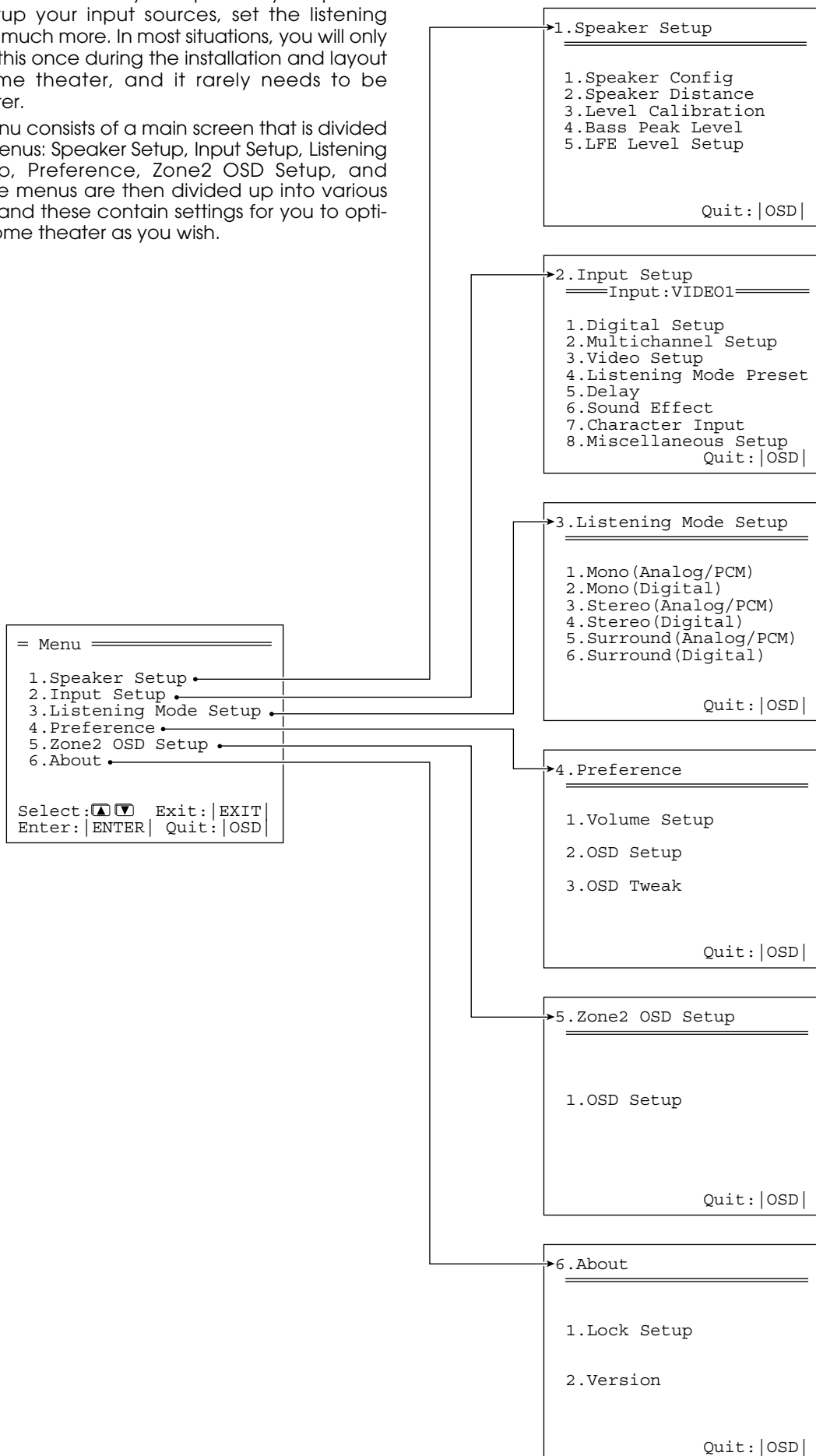

The On-Screen Display (OSD) menu

OSD

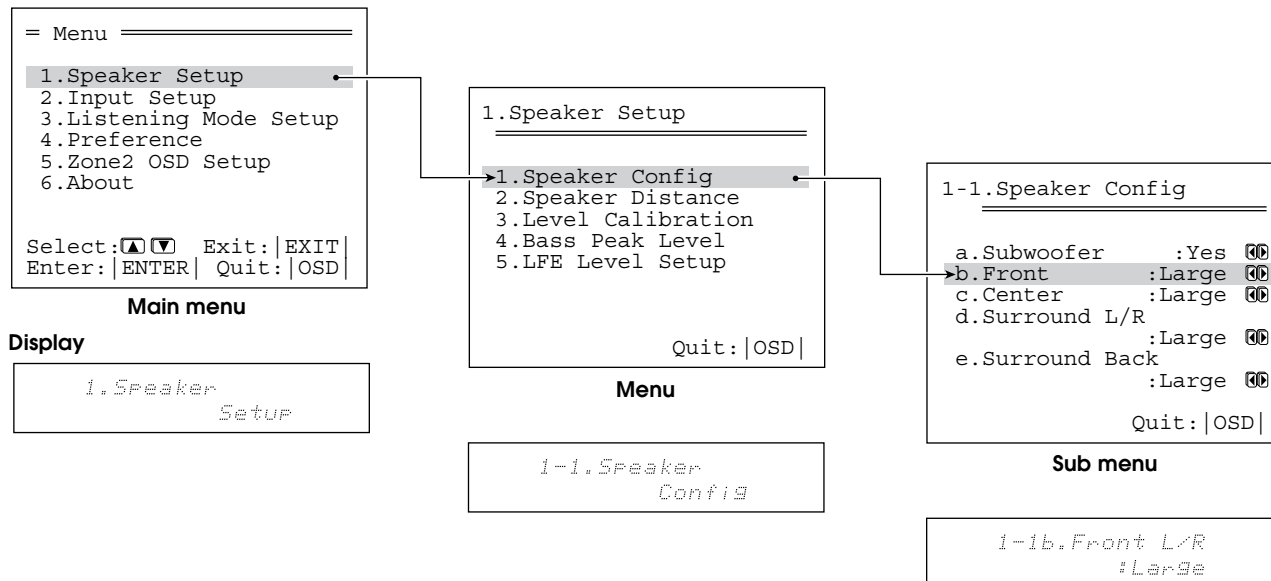

Navigating through the OSD menu

The explanations here assume you are using the buttons on the DTR-9.1 when entering the OSD menu. However, you can use the buttons on the remote controller as well.

The buttons on the remote controller correspond to those on the DTR-9.1 as shown below.

Button on remote controller	Button on DTR-9.1 (under door)
OSD MENU	MENU
(upper edge of ENTER button)	UP
(lower edge of ENTER button)	DOWN
(left edge of ENTER button)	LEFT
(right edge of ENTER button)	RIGHT
ENTER	ENTER
EXIT RETURN	EXIT

1. Press the MENU button.

The main menu screen of the OSD menu appears on your TV monitor.

2. Using the ▲ and ▼ cursor buttons, select the menu that you want to enter.

3. Press the ENTER button to enter the selected menu.

The screen for that menu appears.

4. Using the ▲ and ▼ cursor buttons, select the sub-menu that you want to enter, and press the ENTER button.

Each sub-menu has different settings that can be changed as desired, and they are all explained below. To change a setting, first select it using the ▲ and ▼ cursor buttons, and then change the setting using the ◀ and ▶ cursor buttons.

5. Press the EXIT button to set the new settings and return to the previous menu screen, and again to return to the main screen.

Note:

Press the MENU button to exit the OSD menu immediately.

Speaker Setup

1. Speaker Setup menu

After you have installed the DTR-9.1, connected all the components, and determined the speaker layout, it is now time to perform the settings in the Speaker Setup menu for the optimum sound acoustics for your environment and speaker layout.

Before you perform the following settings, it is important that you first determine the following characteristics:

- The types and sizes of the speakers that are connected.
- The distance from each speaker to your normal listening position.

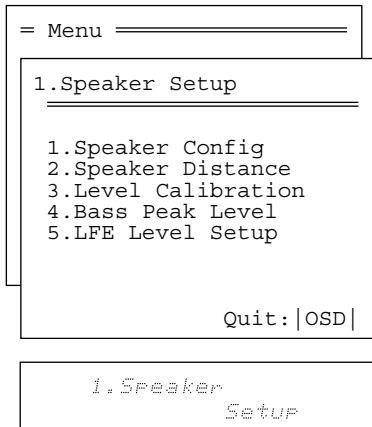

Memo:

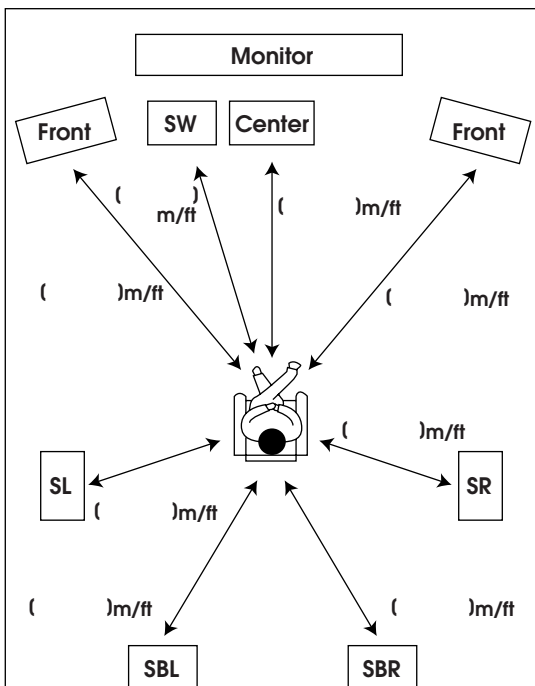

Tip:

When setting the speaker size in the Speaker Config sub-menu, use the guidelines given below.

Large: The complete frequency range for the channel you are setting will be output from the speaker.

Small: Frequencies of the channel you are setting lower than 80 Hz will be output from the subwoofer. If the front speakers are set to "Large," then the sound may be output from both the left and right speakers. (All THX speakers are small.)

1-1. Speaker Config sub-menu

Here you will enter which speakers are connected and the size of each speaker.

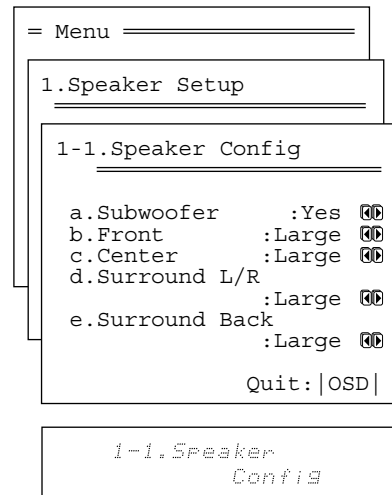

a. Subwoofer

Yes: Select when a subwoofer is connected.

No: Select when a subwoofer is not connected.

b. Front

Large: Select if the front speakers are large sized.

Small: Select if the front speakers are small sized.

- If "No" is selected for the Subwoofer setting, then this setting is fixed to "Large."

c. Center

None: Select if no center speaker is connected.

Large: Select if the center speaker is large sized.

Small: Select if the center speaker is small sized.

- If "Small" is selected for the Front setting, then "Large" cannot be selected for this setting.

d. Surround L/R

None: Select if no surround left and right speakers are connected.

Large: Select if the surround left and right speakers are large sized.

Small: Select if the surround left and right speakers are small sized.

- If "Small" is selected for the Front setting, then "Large" cannot be selected for this setting.

e. Surround Back

None: Select if no surround back left and right speakers are connected.

Large: Select if the surround back left and right speakers are large sized.

Small: Select if the surround back left and right speakers are small sized.

- If "None" is selected for the Surround L/R setting, then this setting is fixed to "None."

- If "Small" is selected for the Surround L/R setting, then "Large" cannot be selected for this setting.

Speaker Setup

1-2. Speaker Distance sub-menu

Here you will enter the distance from each speaker to your normal listening position (Loudspeaker Position Time Synchronization*). This is important for the timing of the acoustics to create the proper sound space that the DTR-9.1 and today's sound systems are able to produce. Note that the speakers that you selected "No" or "None" for in the Speaker Config sub-menu will not appear here.

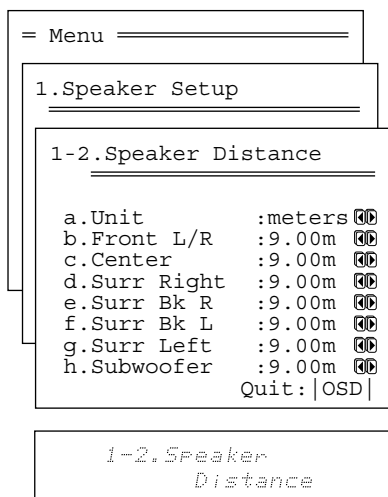

a. Unit

feet: Select if you will enter the distances in feet.

meters: Select if you will enter the distances in meters.

b. Front L/R

Set the distance from the front left and right speakers to your normal listening position between 1 and 30 feet in 0.5-foot intervals (0.3 to 9 meters in 0.15-meter intervals).

Position the front left and right speakers so that they are the same distance from the listener. If they are not, you may lose the center position for stereo sound.

c. Center

Set the distance from the center speaker to your normal listening position between 1 and 30 feet in 0.5-foot intervals (0.3 to 9 meters in 0.15-meter intervals).

- If "None" was selected for the Center setting in the Speaker Config sub-menu, then this setting will not appear.

d. Surr Right

Set the distance from the surround right speaker to your normal listening position between 1 and 30 feet in 0.5-foot intervals (0.3 to 9 meters in 0.15-meter intervals).

- If "None" was selected for the Surround L/R setting in the Speaker Config sub-menu, then this setting will not appear.

e. Surr Bk R

Set the distance from the surround back right speaker to your normal listening position between 1 and 30 feet in 0.5-foot intervals (0.3 to 9 meters in 0.15-meter intervals).

- If "None" was selected for the Surround Back setting in the Speaker Config sub-menu, then this setting will not appear.

f. Surr Bk L

Set the distance from the surround back left speaker to your normal listening position between 1 and 30 feet in 0.5-foot intervals (0.3 to 9 meters in 0.15-meter intervals).

- If "None" was selected for the Surround Back setting in the Speaker Config sub-menu, then this setting will not appear.

g. Surr Left

Set the distance from the surround left speaker to your normal listening position between 1 and 30 feet in 0.5-foot intervals (0.3 to 9 meters in 0.15-meter intervals).

- If "None" was selected for the Surround L/R setting in the Speaker Config sub-menu, then this setting will not appear.

h. Subwoofer

Set the distance from the subwoofer to your normal listening position between 1 and 30 feet in 0.5-foot intervals (0.3 to 9 meters in 0.15-meter intervals).

- If "No" was selected for the Subwoofer setting in the Speaker Config sub-menu, then this setting will not appear.

* Loudspeaker Position Time Synchronization is a registered trademark of Lucasfilm Ltd.

Speaker Setup

1-3. Level Calibration sub-menu

Here you will set the volume for each speaker so that they are all heard by the listener at the same level. This is especially important for speaker layouts where the left and right speakers are at different distances or in asymmetrical positions due to room designs and configurations. These settings and the distance settings performed above are vital to create the proper acoustics required for the optimum sound space and dynamics.

Note:

The speaker level settings here are not effective for multi-channel input sources. To adjust the speaker levels for multi-channel input sources, you will need to use the CH SEL, LEVEL+, and LEVEL- buttons on the RC-418M remote controller. See page 53.

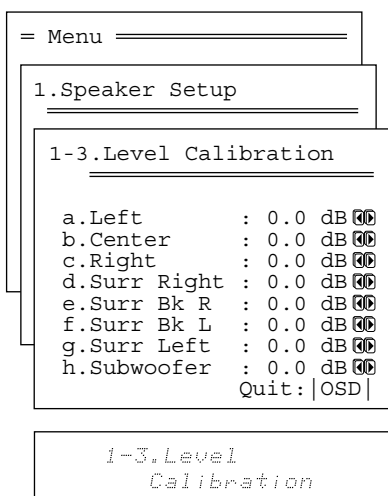

Calibrating the speaker levels

- (1) When this sub-menu is entered, the DTR-9.1 will emit a pink noise from the front left speaker. At this time, the master volume automatically increases to the reference level (0dB). Remember the level of this noise and then press the DOWN cursor button. (Note that this can be adjusted to any level between -12 and 12 decibels in 0.5-decibel intervals.) The DTR-9.1 will now emit the pink noise from the center speaker.
- (2) Using the ◀ and ▶ cursor buttons, adjust the volume level of the noise from the center speaker so that it is the same level as the front left speaker. You can jog back and forth between the speakers to help you compare the volume levels.
- (3) Press the ▼ cursor button again. The DTR-9.1 will now emit the pink noise from the front right speaker.
- (4) Repeat steps (2) and (3) above for the front right and other speakers until all speakers are adjusted to the same volume level.

Notes:

- Speakers that you selected "No" or "None" for in the Speaker Config sub-menu will not appear.
- To accurately set the output levels, it is recommended to use a handheld sound pressure level (SPL) meter. Set the meter to C-weighting and slow averaging. A Radio Shack® SPL meter or equivalent is recommended. Using the internal channel noise generators, set each channel so that you read a 75 decibel sound pressure level.

a. Left

Sound comes from the front left speaker. Adjust the sound level between -12 and 12 decibels in 0.5-decibel intervals.

b. Center

Sound comes from the center speaker. Adjust the sound level between -12 and 12 decibels in 0.5-decibel intervals.

- If "None" was selected for the Center setting in the Speaker Config sub-menu, then this setting will not appear.

c. Right

Sound comes from the front right speaker. Adjust the sound level between -12 and 12 decibels in 0.5-decibel intervals.

d. Surr Right

Sound comes from the surround right speaker. Adjust the sound level between -12 and 12 decibels in 0.5-decibel intervals.

- If "None" was selected for the Surround L/R setting in the Speaker Config sub-menu, then this setting will not appear.

e. Surr Bk R

Sound comes from the surround back right speaker. Adjust the sound level between -12 and 12 decibels in 0.5-decibel intervals.

- If "None" was selected for the Surround Back setting in the Speaker Config sub-menu, then this setting will not appear.

f. Surr Bk L

Sound comes from the surround back left speaker. Adjust the sound level between -12 and 12 decibels in 0.5-decibel intervals.

- If "None" was selected for the Surround Back setting in the Speaker Config sub-menu, then this setting will not appear.

g. Surr Left

Sound comes from the surround left speaker. Adjust the sound level between -12 and 12 decibels in 0.5-decibel intervals.

- If "None" was selected for the Surround L/R setting in the Speaker Config sub-menu, then this setting will not appear.

h. Subwoofer

Sound comes from the subwoofer. Adjust the sound level between -15 and 12 decibels in 0.5-decibel intervals.

- If "No" was selected for the Subwoofer setting in the Speaker Config sub-menu, then this setting will not appear.

Speaker Setup

1-4. Bass Peak Level (Bass Peak Level Manager*) sub-menu

Setting the bass peak level is important to keep your subwoofer from being damaged by preventing it from outputting over a set volume. If your subwoofer has a built-in limiter, set this setting to "Off."

Note:

If your system does not include a subwoofer, this setting will set the bass peak level for your front speakers.

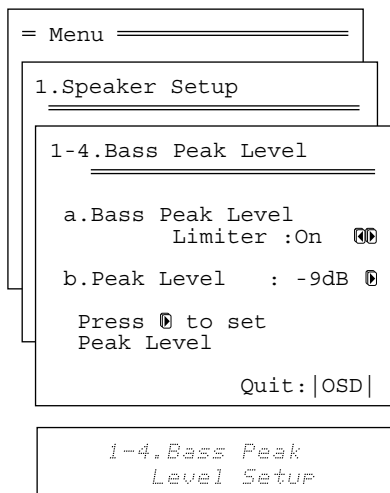

a. Bass Peak Level Limiter

On: Select to set the bass peak level. When "On" is selected, the Peak Level setting appears below.

Off: Select to turn off the bass peak level limiting function.

b. Peak Level

The current bass peak level is displayed. To change the setting, press the ► cursor button. When pressed, a test output tone is emitted from the subwoofer. Then, using the ► cursor button or master volume dial, slowly raise the volume to the point where the sound becomes distorted and then back it off until it returns to normal. This is the proper setting for the bass peak level.

After setting the Peak Level at the Bass Peak Level sub-menu, press the EXIT button. The values are set and the previous screen appears.

Notes:

- The volume can be adjusted to either - or between -81 to +18 decibels in 1-decibel increments.
- Do not allow the distorted sound to be output from the subwoofer for a long time for it may damage the subwoofer.

* Bass Peak Level Manager is a registered trademark of Lucasfilm Ltd.

1-5. LFE Level Setup sub-menu

This sub-menu is for setting the LFE (Low Frequency Effect) levels included in Dolby Digital, DTS, and MPEG software. The default setting is 0 decibels.

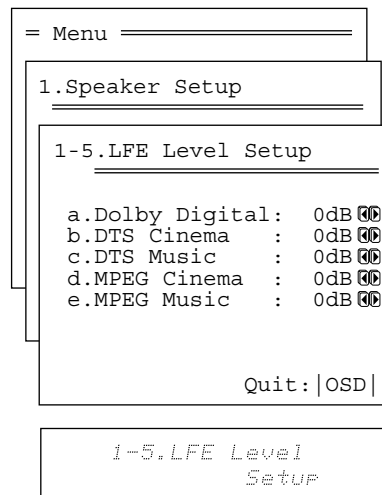

a. Dolby Digital

The level can be adjusted to either - or between -10 to 0 decibels in 1-decibel increments. For Dolby Digital input source signals, the LFE level becomes that set here. A setting of 0 decibels is recommended for optimum performance; however, if the low frequency range is too strong, lower this setting as necessary.

b. DTS Cinema

The level can be adjusted to either - or between -10 to 0 decibels in 1-decibel increments. For DTS input source signals set to a listening mode of DTS Film, THX, Theater-Dimensional, Mono Movie Action, or Musical, the LFE level becomes that set here. A setting of 0 decibels is recommended for optimum performance; however, if the low frequency range is too strong, lower this setting as necessary.

c. DTS Music

The level can be adjusted to either - or between -10 to +10 decibels in 1-decibel increments. For DTS input source signals set to a listening mode of DTS, Enhanced 7, Orchestra, Unplugged, Studio-Mix, TV Logic, or All Ch Stereo the LFE level becomes that set here. A setting of 0 decibels is recommended for optimum performance; however, if the low frequency range is too weak, higher this setting as necessary.

d. MPEG Cinema

The level can be adjusted to either - or between -10 to 0 decibels in 1-decibel increments. For MPEG input source signals set to a listening mode of MPEG Film, THX, Theater-Dimensional, Mono Movie, Action, or Musical, the LFE level becomes that set here. A setting of 0 decibels is recommended for optimum performance; however, if the low frequency range is too strong, lower this setting as necessary.

e. MPEG Music

The level can be adjusted to either - or between -10 to +10 decibels in 1-decibel increments. For MPEG input source signals set to a listening mode of MPEG, Enhanced 7, Orchestra, Unplugged, Studio-Mix, TV Logic, or All Ch Stereo the LFE level becomes that set here. A setting of 0 decibels is recommended for optimum performance; however, if the low frequency range is too weak, higher this setting as necessary.

Input Setup

2. Input Setup menu

This menu allows you to setup the various input sources available with the DTR-9.1. Each input source may have a great number of settings that are difficult to keep track of, so we recommend making a chart to record what you have set and for which component to prevent confusion later.

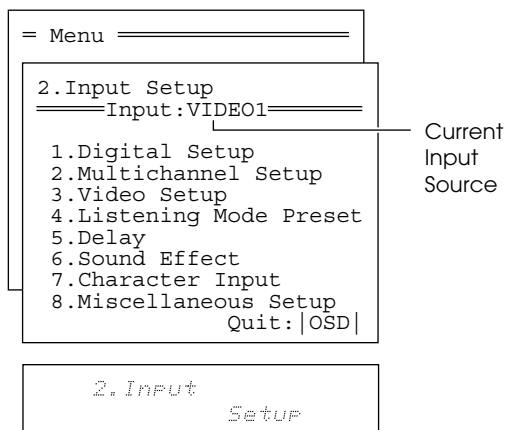

2-1. Digital Setup sub-menu

The settings made in this sub-menu are valid for the input source that is currently selected with the input source buttons at the front panel and, therefore, these settings are made separately for each digital input source. This sub-menu will not appear if the Multichannel setting in the Multichannel Setup sub-menu is set to "On" for the selected input source, or if the selected input source button is AM, FM, or PHONO. If this setting is incorrectly made, the digital audio signals may not be properly output, or not heard at all.

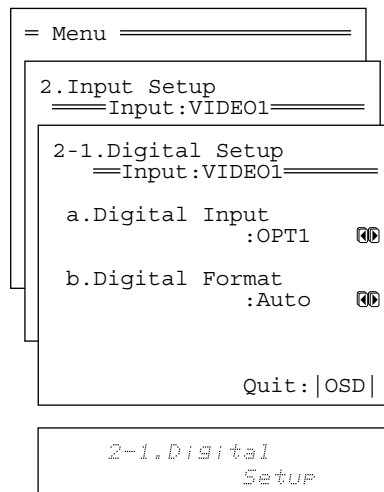

a. Digital Input

This setting tells the DTR-9.1 which input source button on the front panel is connected with which digital input jack on the rear panel. To perform this setting, you must first select a digital input source at the front panel and then set the name of the digital input jack it is connected to here.

For example, if the input source selected at the front panel is CD and the compact disc player is connected to OPTICAL IN 1, then select "OPT1" here. If the input source selected is not connected to a digital input, then select "----."

- OPT1:** Select if connected to DIGITAL INPUT (OPTICAL) 1.
- OPT2:** Select if connected to DIGITAL INPUT (OPTICAL) 2.
- OPT3:** Select if connected to the DIGITAL INPUT (OPTICAL) 3.
- COAX1:** Select if connected to DIGITAL INPUT (COAXIAL) 1.
- COAX2:** Select if connected to DIGITAL INPUT (COAXIAL) 2.
- COAX3:** Select if connected to DIGITAL INPUT (COAXIAL) 3.
- COAX4:** Select if connected to DIGITAL INPUT (COAXIAL) 4.
- COAX5:** Select if connected to DIGITAL INPUT (COAXIAL) 5.
- :** Select if the input source is not from a digital input jack.

b. Digital Format

The default setting is "Auto." If "----" is selected for this input source at the Digital Input setting, then this setting will not appear. Although you can use this default setting as is, you may change it as desired depending on the input signal format (e.g., if you know that you will always be listening to a certain input signal format from a particular input source).

Input Setup

Auto: Select for automatic detection of the input signal format. The input signal format (Dolby Digital, DTS, MPEG, PCM or Analog) used by the selected input source is detected automatically to execute the required decoding process. If no digital signal is input, the input signals to the analog input jacks will be played.

AC-3RF: Select if a LD player with an AC-3RF terminal is connected to the AC-3RF input on the DTR-9.1. AC-3RF can only be selected if VIDEO 4 is selected as the input source.

Digital: Select for automatic detection of a digital input signal format. The input digital signal format (Dolby Digital, DTS, MPEG, or PCM) used by the selected digital input source is detected automatically to execute the necessary decoding process.

DTS: Select for DTS signal processing. The decoding process is executed only when DTS signals are input.

PCM: Select for PCM signal processing. The decoding process is executed only when PCM signals are input.

Analog: Regardless of whether the component is also digitally connected, the audio signals input from the component through the analog input jacks are played.

Notes:

- If "Auto" or "Digital" is selected and a compact disc or LD is fast-forwarded during playback, decoded PCM signals may produce a skipping sound. In such cases, change the setting to "PCM."
- If a compact disc or LD encoded in the DTS format is played back with "PCM" selected, only noise will be produced. Always select "Auto," "Digital," or "DTS" when playing back DTS-encoded sources.

Notes on DTS:

- If you play a CD or LD that supports DTS when the "PCM" setting is selected on the DTR-9.1, the DTS encoded signal will not be decoded and noise will be output. This noise could damage the amplifier and speakers. Therefore, be sure to select "Auto," "Digital," or "DTS" and use the digital input jacks (OPTICAL or COAXIAL) to connect the DTS source.
- If you play a CD or LD that supports DTS when the "Auto" or "Digital" setting is selected, you may hear a noise for a short while until the DTS decoder recognizes the DTS-encoded signal and starts operating. This is not a malfunction.
- If you press the PAUSE or SKIP button on the player while playing a DTS source, a short noise may be heard. This is not a malfunction. In such cases, try playing the source in the "DTS" selected.
- The DTS indicator on the DTR-9.1 lights while a DTS source is played. When playback finishes and the DTS signal transmission stops, the DTR-9.1 remains in DTS mode and the DTS indicator remains lit. This prevents noise when you operate the PAUSE or SKIP button on the player. Therefore, if the source is immediately switched from DTS to PCM, the PCM signal may not be played. In this case, stop the playback of the source on the player for about three seconds and then resume playback.
- You may not be able to play some DTS source signals from certain CD players and LD players even if you connect the player to the DTR-9.1 digitally. This is because the digital signal has been processed (such as the output level, sampling frequency, or frequency response) and the DTR-9.1 cannot recognize the signal as DTS data. Therefore you may hear noise when you play a DTS source while processing the signal.
- The outputs for the VIDEO 1 OUT, VIDEO 2 OUT, TAPE 1 OUT, and TAPE 2 OUT output analog audio signals. Do not record from CDs or LDs that support DTS using these outputs. If you do, the DTS-encoded signal will be recorded as noise.

Input Setup

2-2. Multichannel Setup sub-menu

This sub-menu will not appear if AM, FM, or PHONO is selected at the front panel for the input source. This setting is normally set to "No," and only needs to be changed to "Yes" if a DVD player, MPEG decoder, or other component that has a multi channel port is connected to the MULTI CHANNEL INPUT port for 5.1-channel or 7.1-channel audio. For example, if a DVD player is connected to the MULTI CHANNEL INPUT port, then select DVD at the front panel as the input source, bring up this sub-menu, and select "Yes" for the Multichannel setting. When "Yes" is selected, the audio from the MULTI CHANNEL INPUT is given preference.

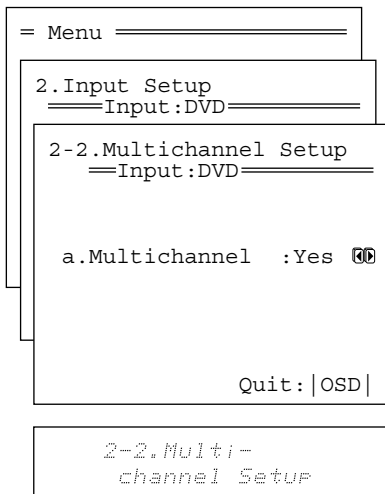

2-3. Video Setup sub-menu

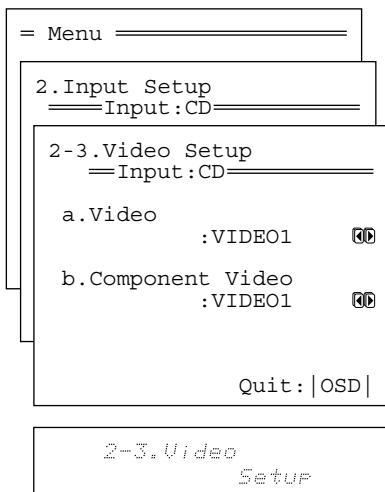

a. Video

This setting allows you to match the audio from one component with the video from another. Therefore, you can set a video source to be displayed while the audio from another input source is heard. For example, this allows you to play the music from a compact disc, while displaying the picture from a video cassette player or other video source. Since the settings in this sub-menu are also linked to the input source that is currently selected at the front panel, a different setting can be made for each digital input source.

The default settings are given below.

Input source selected	Video
CD	Last valid
PHONO	Last valid
FM	Last valid
AM	Last valid
TAPE1	Last valid
TAPE2	Last valid
DVD	DVD
VIDEO1	VIDEO1
VIDEO2	VIDEO2
VIDEO3	VIDEO3
VIDEO4	VIDEO4
VIDEO5	VIDEO5

Last valid: When you change to an input source set to "Last valid," the video of the input source that you changed from is continued. For example, if the selected input source is VIDEO 1, and you then change to CD (set to "Last valid"), then the audio from the CD input is played while the video from VIDEO 1 continues.

b. Component

If a component is connected to the one of the COMPONENT VIDEO inputs (1, 2, or 3), then that input must be set here. This setting will not appear if AM, FM, PHONO, CD, TAPE1, or TAPE2 is selected as the input source.

The default settings are given below.

Input source selected	Setting
DVD	COMPONENT VIDEO 1
VIDEO1	----
VIDEO2	COMPONENT VIDEO 2
VIDEO3	COMPONENT VIDEO 3
VIDEO4	----
VIDEO5	----

Input Setup

2-4. Listening Mode Preset sub-menu

With the DTR-9.1, you can set a different listening mode for each different signal type that comes from each input source and also set the parameters for the listening mode itself. For example, if your DVD player also plays compact discs and the DVD video signal is DTS and the compact disc signal is PCM, then you can set a different listening mode for each.

This is especially convenient if you frequently play the same types of movies or music.

Note that some listening modes cannot be set for some input sources. In addition, if "Yes" is set for multi channel for the input source selected, then the listening mode cannot be set. Also, if the "----" is set for the Digital Input setting in the Digital Input Setup sub-menu, then you can only select "Analog/PCM."

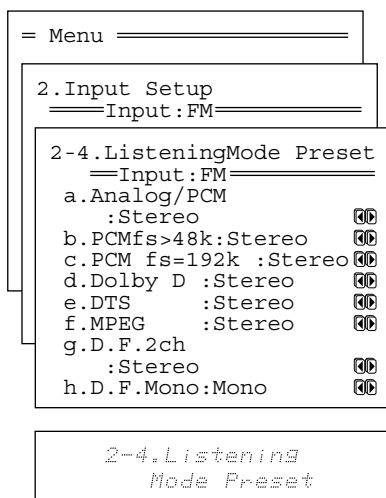

* The 5.1-channel digital surround format has a variety of versions including Dolby Digital, DTS, and MPEG. The 5.1-channel digital surround format enables you to individually record and play five full-range (20Hz-20kHz) channels (left and right front, center, two surround channels) plus an LFE channel (Low Frequency Effect) for the low-range effect sound. It will create a realistic sound that could be heard in the theaters and concert halls.

Relationship between input source and listening mode

Input source signal (display) Type of software	Analog/PCM Tape, CD, Record, Tuner	PCM fs>48k Audio DVD, Video DVD	PCM fs=192k Audio DVD,	Dolby D Video DVD, LD, Digital satellite broadcast	DTS CD, LD, Video DVD	MPEG Video DVD,	D.F.2ch* Video DVD, LD	D.F.Mono* Video DVD, LD
Listening mode								
Mono	●						●	●
Direct	●	●	●					
Stereo	●	●	●	●	●	●	●	
T-D (Theater-Dimensional)		●			●	●	●	●
Dolby D (Dolby Digital)				●				
DTS					●			
DTS Film					●			
MPEG (MPEG Multichannel)						●		
MPEG Film						●		
THX Cinema				●	●	●		
Action				●	●	●		
Musical				●	●	●		
(Dolby Pro Logic) (3 Stereo)*	●	●					●	
(Dolby Pro Logic) THX Cinema	●						●	
(Dolby Pro Logic) Action		●						●
(Dolby Pro Logic) Musical		●						●
Mono Movie	●						●	●
Enhance7	●			●	●	●	●	
Orchestra Unplugged Studio-Mix TV Logic	●			●	●	●	●	
All Ch Stereo	●						●	

The listening modes that can be set are different for each input source format.

* If Dolby Pro Logic is set for the listening mode and there are no surround speakers, then the listening mode becomes 3 Stereo.

Input Setup

Input source signals

a. Analog/PCM

Analog sources consist of LP records, AM and FM broadcasts, cassette tapes, and the such. PCM (Pulse Code Modulation) is one form of digital audio signals and is recorded directly onto compact discs and DVDs without compression.

b. PCM fs > 48 k

Digital PCM sources that are recorded at a sampling rate of greater than 48 kilohertz. This includes compact discs and DVDs that are recorded with high quality audio.

c. PCM fs = 192 k

Digital PCM sources that are recorded at a sampling rate of greater than 192 kilohertz. This includes compact discs and DVDs that are recorded with extremely high quality audio.

d. Dolby D (Dolby Digital)

Digital data with AC-3 compression and a maximum of 5.1-channel surround sound. This source signal comes from DVDs and LDs that have the  mark and therefore recorded for 5.1-channel output. This source also comes from digital satellite broadcasts that support Dolby Digital.

Dial norm

Dialogue Normalization (Dial Norm) is feature of Dolby Digital. When playing back software that has been encoded in Dolby Digital, sometimes you may see a brief message in the front panel display that read Dial Norm xdB ("x" being a numeric value). Dialogue Normalization serves to let you know if the source material has been recorded at a higher or lower level than usual. For example, if you see the message "Dial Norm: +4" in the front panel display, to keep the overall output level constant just turn down the volume control by 4dB. In other words, the source material that you are listening to has been recorded 4dB louder than usual. If you do not see a message, then no adjustment of the volume control is necessary.

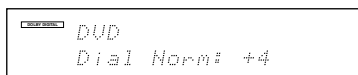

e. DTS

DTS (Digital Theater System) is compressed digital data with a maximum 5.1-channel surround output that allows for an extremely high-quality sound. This source signal requires a DVD player that supports DTS output and comes from compact discs, DVDs, and LDs that have the  mark.

f. MPEG

Digital data with a maximum of 5.1-channel surround audio with MPEG compression. This source signal comes from DVDs that have the  (Multichannel) mark.

g. D.F. 2 ch

This corresponds to 2-channel digital format sources. This signal source comes from LDs, DVDs, and other digital sources that are recorded with 2-channel audio.

h. D.F. Mono

This corresponds to monaural digital format sources. This signal source comes from LDs, DVDs, and other digital sources that are recorded with monaural audio.

Listening Modes

Mono

This mode is for listening to the left and right channels separately. This mode also allows you to listen to the multiplexed soundtracks on DVDs, and other media that have them.

Stereo

This mode has all input sound is output from the left and right front speakers.

Direct

This mode delivers pure sound with minimum sound quality adjustment and filtration. The sound recorded for the right and left front channels is output to the right and left front speakers only and not output to the subwoofer.

Dolby D (Dolby Digital)

This mode is for listening to sources encoded with Dolby Digital in their plain format.

DTS

This mode is for listening to music DTS sources in their plain format.

DTS Film

This mode is for listening to cinema DTS sources in their plain format.

MPEG

This mode is for listening to music MPEG sources in their plain format.

MPEG Film

This mode is for listening to cinema MPEG sources in their plain format.

THX (THX Cinema)

Movies that have been encoded in Dolby Digital, DTS, MPEG, and Dolby Pro Logic can all benefit by activating the THX mode. THX should be activated only when watching movies that were mixed for playback in large movie theater environments. THX need not be activated for music, for movies that were made especially for television, or for shows such as sports programming, talk shows, and the like. This is because they were mixed in a small room environment.

For best results, use a THX certified speaker system.

• How to enjoy THX Surround EX

When the THX listening mode is selected, you can press the THX button on the remote controller to cycle through the settings "Auto," "On," and "Off." When "Auto" is selected, if a Surround EX encoded source is input, it is automatically played in the THX Surround EX mode. When "On" is selected, all surround EX encoded sources and THX Surround EX playable sources (i.e., DTS-ES encoded sources) are played in the THX Surround EX mode. If the sound does not feel correct, set this to "Off."

If "On" is selected and a source that cannot be played in the THX Surround EX mode, "THXCinema" appears in the front display. If "Off" is selected, the listening mode becomes THX Cinema.

Input Setup

Note:

THX Surround EX can only be selected if the surround back speakers are connected.

THX Surround EX

"THX Surround EX - Dolby Digital Surround EX" is a joint development of Dolby Laboratories and the THX division of Lucasfilm Ltd.

In a movie theater, film soundtracks that have been encoded with Dolby Digital Surround EX technology are able to reproduce an extra channel which has been added during the mixing of the program. This channel, called Surround Back, places sounds behind the listener in addition to the currently available front left, front center, front right, surround right, surround left, and subwoofer channels.

This additional channel provides the opportunity for more detailed imaging behind the listener and brings more depth, spacious ambience and sound localization than ever before.

When released to the home consumer market, movies that were created using the Dolby Digital Surround EX technology, may have a note to that effect on the packaging. A list of movies created using this technology can be found on the Dolby web site at <http://www.dolby.com> <<http://www.dolby.com>> .

Only receiver and controller products bearing the THX Surround EX logo, when in the THX Surround EX mode, faithfully reproduce this new technology in the home.

This product may also engage the "THX Surround EX" mode during the playback of 5.1 channel material that is *not* Dolby Digital Surround EX encoded. In such case the information delivered to the Surround Back channel will be program dependent and may or may not be very pleasing depending on the particular soundtrack and the tastes of the individual listener.

Action

This mode is designed for movie soundtracks that stress special effect sounds and surround effects. In addition to strengthening the low frequency ranges for the front left, front right, and surround speakers, it also increases the surround levels. Resonance is also cut for a movie-theater feeling and increased enjoyment.

Musical

This mode is designed for watching musicals and movie soundtracks where importance is placed on the music. By slightly increasing the mid to high frequency ranges from the center speaker, the vocals from the screen seem highlighted for added listening pleasure. This mode is optimum for playing software that stresses music, environmental sounds, and the front image.

Pro Logic/3 Stereo (Dolby Pro Logic/3 Stereo)

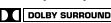
This mode is for listening to recordings with Dolby surround, which consists of four channels (left, right, center, and monaural surround) and emphasizes the center channel. Dolby Pro Logic is very effective for panning music, conversation, and three-dimensional sound movement output from the three front channels. It also simulates the atmosphere and surround effects of the sound reflected from the side and rear walls of the theater. Select this listening mode when you play a VHS, VHS hi-fi, LD, or DVD video that has the  mark.

If no surround speakers are connected, then the surround sound is divided and output from the front left and right channels.(3 Stereo)

Pro Logic THX (Dolby Pro Logic THX)

This mode is the same as the Dolby Pro Logic listening

mode with the THX effects added as well. Select this mode when listening to movies that were encoded using Dolby Pro Logic.

Pro Logic Action (Dolby Pro Logic Action)

When listening to movies using the Dolby Pro Logic, this mode allows you to further enhance the cinematic quality by adding processing that emphasizes the sounds of the action special effects.

Pro Logic Musical (Dolby Pro Logic Musical)

When listening to music using the Dolby Pro Logic, this mode allows you to further enhance the sound quality by adding processing that emphasizes the musical effects.

Mono Movie

This mode is suitable for playing back monaural recording such as old movie soundtracks. The center channel delivers the unprocessed original sound, whereas the other channels deliver the center-channel sound processed with the appropriate reverberation. This allows you to enjoy monaural sound with the atmosphere of a movie theater.

T-D (Theater-Dimensional)

For the best enjoyment of your home theater, it is recommended that you have at least front left and right speakers, a center speaker, and surround left and right speakers. However, if you do only have front left and right speakers, you can enjoy multichannel audio by using this mode.

This mode controls the characteristics of the sound that reaches each ear to reproduce a multi-speaker setup. To receive the full effect, there is an optimum listening position (sweet spot). Refer to the explanation of the listening angle. In addition, if the reflective sound components are large, it may be difficult to achieve the desired result, so be sure to set up your system and listening position to minimize reflective sound.

Enhanced 7

Enhanced 7 intends to reproduce a natural surround environment by using 7-channel speakers. The sound effects moving smoothly toward the surround back. This mode is good for music and TV sports programs.

Orchestra

This mode is appropriate for classical and opera music. The center channel is cut and the surround channels are emphasized to widen the stereo image. It will simulate the natural reverberation that is created in large halls.

TV Logic

This mode gives realistic acoustics to TV programs that are aired from TV studios. It enhances the entire surround sound and clarity of the conversation.

Unplugged

This mode is suitable for acoustical instrumental sounds, vocals, and jazz music. By emphasizing the front stereo image, it will simulate the acoustics that you would experience in front of the stage.

Studio-Mix

This mode is for rock and popular music. The lively sounds are enhanced for a powerful acoustic image that simulates the feeling of being in a club or rock concert.

All Ch Stereo

This mode is designed for playing background music. The front, surround, and surround back channels create a stereo image that encompasses the entire area.

Input Setup

2-5. Delay sub-menu

This sub-menu gives you various ways to adjust the timing of the audio output from the speakers to give certain soundfield effects or to adjust for unwanted asynchronous video and audio tracks.

This sub-menu does not appear if "Direct" is selected as the listening mode.

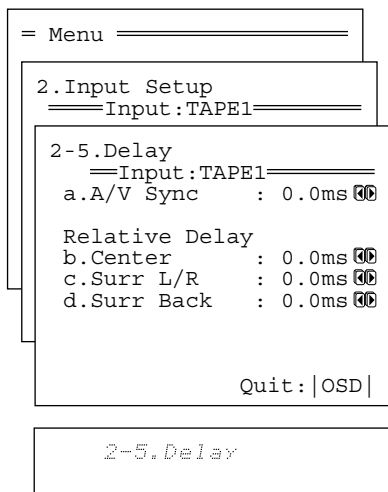

a. A/V Sync

If a digital signal processor is connected, there may be times when the audio and video from a DVD or LD player is not output in perfect sync. The result is where the sound and picture do not match and the sound is heard too early. In such a case, use this setting to properly synchronize the audio and video. This setting can be set between 0 to 30 ms in 0.5-ms increments. Under normal circumstances, this can left at 0 ms. For input sources using the multi channel port, this setting will not appear.

b. Relative Delay

Besides level and delay adjustments, the DTR-9.1 provides the ability to change or adjust the relative speaker position to fine tune the soundfield for the listener. This is accomplished using Integra's unique Enhanced Spatial Positioning Algorithm. This adjustment provides 10 milliseconds of delay for the speakers, which is equivalent to moving the speaker 10 feet away. This adjustment is set up to provide -4 or +6 milliseconds (-4 or +6 feet) of adjustment to the listener's position.

Once the coarse adjustments-speaker level and distance adjustments-are made, the system is set up to provide a typical or broad surround environment. By adjusting the relative position of the speakers, we are able to alter the soundfield to be more spread out (deeper) or focused (shallower).

2-6. Sound Effect sub-menu

This sub-menu allows you to increase or decrease only the low (bass) or high (treble) frequency sounds or adjust the volume for a particular input source. This sub-menu does not appear if "Direct" or "THX Mode" are selected as the listening mode.

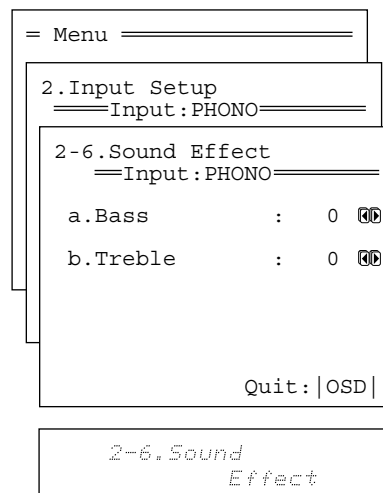

a. Bass

Press the ◀ cursor button to decrease the bass sounds and press the ▶ cursor button to increase the bass sounds. The bass can be adjusted between -12 and +12 decibels in two steps.

b. Treble

Press the ◀ cursor button to decrease the treble sounds and press the ▶ cursor button to increase the treble sounds. The treble can be adjusted between -12 and +12 decibels in two steps.

Input Setup

2-7. Character Input sub-menu

This sub-menu allows you to give names to the stations you have preset for the AM/FM tuner, and to the input sources you have connected (excluding the tuner itself). Up to 10 characters can be entered for each name. For example, if you have a DVD connected to the VIDEO5 input jack, then you can give it the name "DVD2." Or, if you have multiple VCRs connected, you can enter the model names or manufacturer names for each one so that you do not have to remember which is connected to which input source.

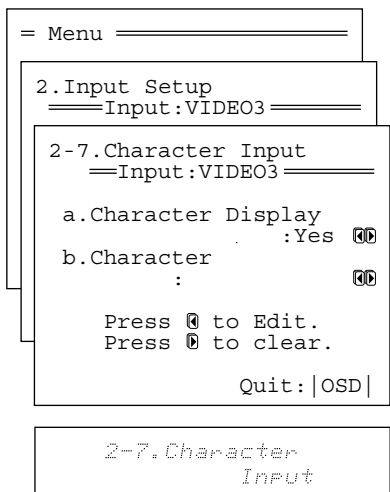

a. Character Display

Yes: Select to display the name you enter when the input source is selected.

No: Select to display the default name.

b. Character

If you have selected "Yes" for the Character Display above, then here you can enter the name that you want to display. Press ◀ cursor button to clear the current entry. Press ▶ cursor button to bring up the Character Input screen.

At the Character Entry screen, press the cursor buttons to move the cursor to the desired character and then press the ENTER button. That character will now appear in the 10-character space field. Continue until the name is finished or until you have reached 10 characters.

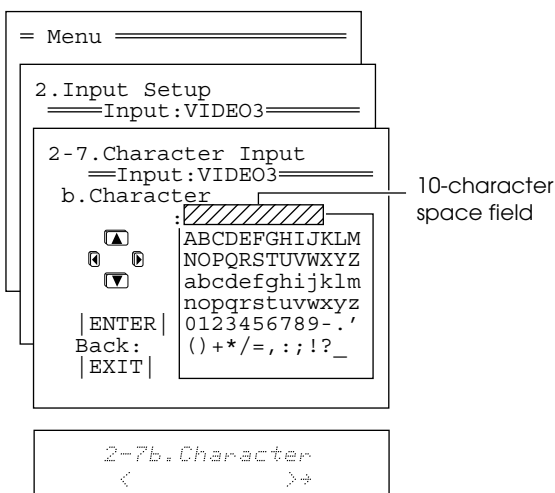

Using the cursor buttons, select the desired character and press the ENTER button. To change a character, move the cursor backward with the EXIT button or forward with the ENTER button to the location of mistaken character and enter the desired character. To erase a character, enter a blank space in its place. After completing the name, to exit, repeatedly press the ENTER button. Continue until the name is finished or until you have reached 10 characters.

2-8. Miscellaneous Setup

This sub-menu allows you to set some of the special features offered by the DTR-9.1.

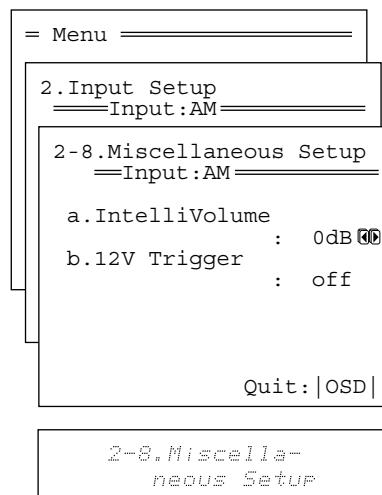

a. IntelliVolume

When switching input sources, you may find that the output level for different components or input sources connected to the DTR-9.1 is different even though the main volume setting is the same. Under normal circumstances, you would then have to change the volume setting each time you change the input source. This IntelliVolume setting allows you to preset a volume level for each input source separately so that when you do switch from one input source to another, the DTR-9.1 adjusts the volume accordingly so that the resulting volume stays the same. To set the IntelliVolume, simply select an input source at the front panel, and if that source is quieter than other sources, increase its decibel level with the ▶ cursor button, or if it is louder than other sources, decrease its decibel level with the ◀ cursor button.

The IntelliVolume can be adjusted between -12 and +12 decibels.

b. 12V Trigger

Here you can set the condition of the 12V TRIGGER terminals for each input source.

Off: Select to have no output from either terminal A or B.

A: Select to have output from terminal A only.

B: Select to have output from terminal B only. With terminal B, to avoid problems that may occur if the external device is turned on simultaneously, the output is delayed by 2 seconds.

A+B: Select to have output from both terminals A and B.

Listening Mode Setup

3. Listening Mode Setup menu

This menu allows you to make fine adjustments to the listening modes you have set for each input source with the Listening Mode Preset sub-menu. These adjustments are in the form of parameters and each one is explained below. Note that some parameters cannot be set for some listening modes and that no sub-menu will have all parameters. Also, for some input signal formats, changes in the listening mode parameters may actually result in no change to the resulting output signal.

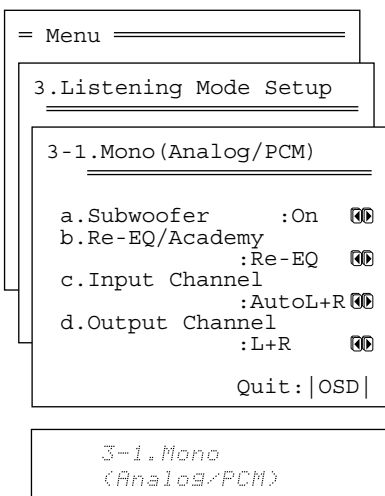
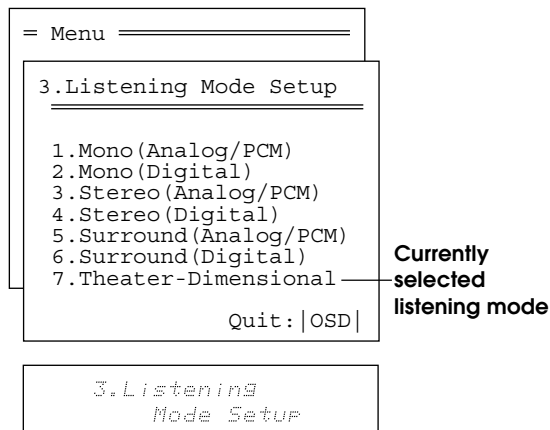

3-1. Mono (Analog/PCM) Setup

Select this to modify the Mono listening mode when the current source is analog or PCM. The parameters that can be set are shown in the table below.

	Parameter	Setting Initial value
a	Subwoofer	Off, On
b	Re-EQ/Academy	Off, Re-EQ, Academy
c	Input Channel	Auto L+R, Left, Right
d	Output Channel	L+R, Center

3-2. Mono (Digital) Setup

Select this to modify the Mono listening mode when the current source is digital. The parameters that can be set are shown in the table below.

	Parameter	Setting Initial value
a	Subwoofer	Off, On
b	Re-EQ/Academy	Off, Re-EQ, Academy
c	Input Channel	Auto L+R, Left, Right
d	Output Channel	L+R, Center

3-3. Stereo (Analog/PCM) Setup

Select this to modify the Stereo listening mode when the current source is analog or PCM. The parameters that can be set are shown in the table below.

	Parameter	Setting Initial value
a	Subwoofer	Off, On
b	Re-EQ/Academy	Off, Re-EQ, Academy
c	Digital Upsampling	Off, On

The c. Digital Upsampling can only be set for PCM input sources and cannot be set for analog ones.

3-4. Stereo (Digital) Setup

Select this to modify the Stereo listening mode when the current source is digital. The parameters that can be set are shown in the table below.

	Parameter	Setting Initial value
a	Subwoofer	Off, On
b	Re-EQ/Academy	Off, Re-EQ, Academy

3-5. Surround (Analog/PCM) Setup

Select this to modify the Pro Logic Surround listening mode when the current source is analog or PCM. The parameters that can be set are shown in the table below.

	Parameter	Setting Initial value
a	Subwoofer	Off, On
b	Re-EQ	On, Off
c	Surround Speakers	Surround L/R, Surround Back, Surround L/R+Back
d	Digital Upsampling	Off, On

The d. Digital Upsampling can only be set for PCM input sources. Furthermore, if this is set to On, c. Surround Speaker is fixed to "Surround L/R."

Listening Mode Setup

3-6. Surround (Digital) Setup

Select this to modify the plain Dolby Digital, DTS, MPEG, and Pro Logic Surround listening modes when the current source is digital. The parameters that can be set are shown in the table below.

	Parameter	Setting Initial value
a Subwoofer	Off, On	On
b Re-EQ	Off, On	Off
c Surround Speakers	Surround L/R, Surround Back, Surround L/R+Back	Surround L/R

3-7. THX Setup

Select this to modify the THX Cinema or Pro Logic THX listening modes; the one that is currently set is the one that is modified. The parameters that can be set are shown in the table below.

	Parameter	Setting Initial value
a Subwoofer	Off, On	On
b Re-EQ	Off, On	On
c Surround Speakers	Surround L/R, Surround Back, Surround L/R+Back	Surround L/R

3-7. DTS Film Setup, MPEG Film Setup

Select this to modify the DTS Film or MPEG Film listening modes; the one that is currently set is the one that is modified. The is currently set is the one that is modified. The parameters that can be set are shown in the table below.

	Parameter	Setting Initial value
a Subwoofer	Off, On	On
b Re-EQ	Off, On	Off
c Surround Speakers	Surround L/R, Surround Back, Surround L/R+Back	Surround L/R

3-7. +Action Setup, +Musical Setup

Select this to modify the Action, Musical, Dolby Pro Logic Action, or Dolby Pro Logic Musical listening modes; the one that is currently set is the one that is modified. The parameters that can be set are shown in the table below.

	Parameter	Setting Initial value
a Subwoofer	Off, On	On
b Re-EQ	Off, On	Off
c Surround Speakers	Surround L/R, Surround Back, Surround L/R+Back	Surround L/R
d Front Effect	Off, On	On
e Reflect Level	-5dB to +5dB	0dB
f Reverb Level	-5dB to +5dB	0dB
g Room Size	Small, Mid-small, Middle, Mid-large, Large	Middle

3-7. Theater-Dimensional Setup

Select this to modify the Theater-Dimensional (T-D) listening modes. The parameters that can be set are shown in the table below.

	Parameter	Setting Initial value
a Subwoofer	Off, On	On
b Listening Angle	20deg, 40deg	20deg
c Center	Off, On	Off
d Front Expander	Off, On	On
e Virtual Surr Level	-3dB to +3dB	0dB
f Dialog Enhance	Off, On	Off

3-7. Enhanced 7 Setup

Select this to modify the Enhanced 7 listening mode. The parameters that can be set are shown in the table below.

	Parameter	Setting Initial value
a Subwoofer	Off, On	On
b Re-EQ	Off, On	Off
c Front Effect	Off, On	On
d Reflect Level	-5dB to +5dB	0dB
e Reverb Level	-5dB to +5dB	0dB
f Room Size	Small, Mid-small, Middle, Mid-large, Large	Middle

3-7.Orchestra Setup, Unplugged Setup, Studio-Mix Setup, TV Logic Setup

Select this to modify the Orchestra, Unplugged, Studio-Mix, and TV Logic listening modes; the one that is currently set is the one that is modified. The parameters that can be set are shown in the table below.

	Parameter	Setting Initial value
a Subwoofer	Off, On	On
b Re-EQ	Off, On	Off
c Surround Speakers	Surround L/R, Surround Back, Surround L/R+Back	Surround L/R
d Front Effect	Off, On	On
e Reflect Level	-5dB to +5dB	0dB
f Reverb Level	-5dB to +5dB	0dB
g Room Size	Small, Mid-small, Middle, Mid-large, Large	Middle

3-7. All Ch Stereo Setup

Select this to modify the All Ch Stereo listening mode. The parameters that can be set are shown in the table below.

	Parameter	Setting Initial value
a Subwoofer	Off, On	On
b Re-EQ	Off, On	Off

3-7. Mono Movie Setup

Select this to modify the Mono Movie listening mode. The parameters that can be set are shown in the table below.

	Parameter	Setting Initial value
a Subwoofer	Off, On	On
b Re-EQ/Academy	Off, Re-EQ, Academy	Off
c Surround Speakers	Surround L/R, Surround Back, Surround L/R+Back	Surround L/R
d Front Effect	Off, On	On
e Reflect Level	-5dB to +5dB	0dB
f Reverb Level	-5dB to +5dB	0dB
g Room Size	Small, Mid-small, Middle, Mid-large, Large	Middle

Listening Mode Setup

Description listening mode parameters

Subwoofer

Set this to "Off" if you are not using a subwoofer (even if one is connected). If "No" is selected for the Subwoofer setting in the Speaker Config sub-menu, then this setting will not appear.

Re-EQ/Academy

Depending on the listening mode, you can either turn Re-EQ on or off, or you can select "Re-EQ," "Academy," or "Off."

Re-EQ: Re-EQ (re-equalization) takes the edginess or "brightness" out of your home cinema sound to compensate for the fact that sound mixed for theaters may sound too bright when played back through speakers in the home environment.

Academy: Older monaural film mixes relied on high-frequency rolloff in presentation to sound properly balanced, so that excessive hiss from the grain structure of the film would not be heard. The high-frequency loss was typically due to a combination of optical slit loss, electrical filters, loudspeaker response, and screen loss. Some films have been transferred to video without such a high-frequency rolloff, and thus sound overly bright and hissy. The DTR-9.1 includes this "Academy filter," which is based on contemporary playback practices for such films over wide-range systems.

On: Select to turn on the Re-EQ.

Off: Select to turn off both the re-equalization and Academy filters.

Input Channel

This allows you to set which input channel to use for monaural sound.

Auto L+R: Select this under normal circumstances for output from both the left and right speakers.

Left/Right: You will need to select either left or right when playing a video source that contains bilingual data. In such a case, the left and right channels will contain different language. Select the channel with the language you desire.

Output Channel

This allows you to set which output channel to use for monaural sound. If "None" is selected for the Center Speaker setting in the Speaker Config sub-menu, then this setting will not appear.

L+R: The monaural sound is split between the left and right channels.

Center: The monaural sound is output from the front center channel.

Digital Upsampling

Digital upsampling processes the input digital signal and converts its digital sampling frequency to twice the current frequency for an even further detailed sound reproduction. This can be set to either "On" or "Off."

Surround Speakers

This setting allows you to decide through which speakers to output the sound meant for the surround speakers during 5.1-channel output when seven speakers are connected to the DTR-9.1.

Surround L/R: This outputs the sound to the surround left and right speakers as normal and outputs nothing to the surround back left and right speakers.

Surround Back: This outputs the sound to the surround back left and right speakers and outputs nothing to the surround left and right speakers.

Sur L/R+Back: This outputs the sound to both the surround left and right speakers and the surround back left and right speakers.

Front Effect

Some live recordings contain acoustic reverberation. When you play these sources, more reverberation will be applied by the DSP, creating too much reverb effects and the sound loses frame or presence. In this case, set this setting to "Off." No reverberation from the DSP will be applied to the sound output from the three front channels, so the sound source is played as it is without any further reverberation.

Reflect Lvl

This parameter allows you to adjust the strength of direct sound reflections to match the playback source material, the acoustics of your room, and such other factors. This can be set between -5 and +5 decibels in 1-decibel increments.

Reverb Lvl

This parameter allows you to adjust the depth of acoustic reverberation to match the playback source material, the acoustics of your room, and such other factors. This can be set between -5 and +5 decibels in 1-decibel increments.

Room Size

This parameter allows you set virtual hall size to simulate for each surround mode. You can choose from "Large," "Mid-Large," "Middle," "Mid-Small," or "Small."

Listening angle

The listening angle is the angle subtended by the front left and right speakers as seen from the listener. The setting of 20 and 40 degrees are only for nominal purposes, so select the setting that is closest to your actual listening angle.

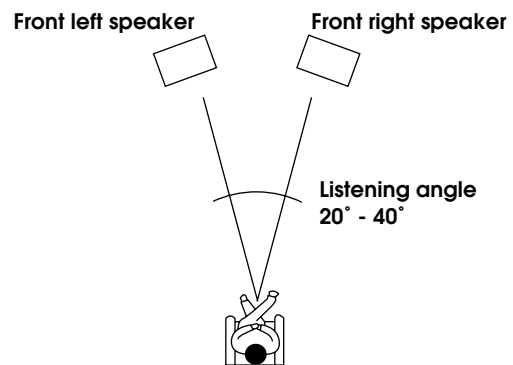

Listening Mode Setup

Center

For systems that have a center speaker, the center channel signal can be output from the center speaker. For instance, in systems where the front left and right speakers are small, use of the center speaker may provide a better sound space. (If your system uses a center speaker, be sure to perform the level calibration with the left and right speakers in the Speaker Setup menu beforehand.)

On: The center channel signal is output to the center speaker.

Off: The center channel signal is output from the front left and right speakers (Phantom Center).

Front Expander

The front expander function spreads out the sound from the front speakers for the feeling of a wide sound space.

On: Select to turn on the front expander function to simulate a wider sound space.

Off: Select to turn off the front expander function for a normal sound space.

Virtual Surr Level

This parameter adjusts the virtual surround level. This can be set from -3 to +3 decibels.

Dialog Enhance

This parameter allows you to adjust the dialog sound level from the center speaker if it is difficult to hear.

On: Enhances the vocal ranges for the center channel signal.

Off: Outputs the center channel signal at the regular level and frequency characteristics.

Relationship between listening mode and parameter

Listening mode Parameter	Direct	Mono (Analog/PCM)	Mono (Digital)	Stereo (Analog/PCM)	Stereo (Digital)	Surround* (Analog/PCM)	Surround* (Digital)	THX Cinema
Subwoofer		●	●	●	●	●	●	●
Re-EQ (/Academy)		●	●	●	●	●	●	●
Input Channel		●	●					
Output Channel		●	●					
Surround Speakers						●	●	●
Digital Upsampling				●		●		
Front Effect								
Reflect Level								
Reverb Level								
Room Size								
Listening Angle								
Center								
Front Expander								
Virtual Surr Level								
Dialog Enhance								

Listening mode Parameter	DTS Film	MPEG Film	+Action**/ +Musical	Theater Dimensional (T-D)	Enhance7	Orchestra/ Unplugged/ Studio-Mix/ TV Logic/ Mono Movie	All Ch Stereo
Subwoofer	●	●	●	●	●	●	●
Re-EQ (/Academy)	●	●	●		●	●	●
Input Channel							
Output Channel							
Surround Speakers	●	●	●			●	
Digital Upsampling							
Front Effect			●		●	●	
Reflect Level			●		●	●	
Reverb Level			●		●	●	
Room Size			●		●	●	
Listening Angle				●			
Center				●			
Front Expander				●			
Virtual Surr Level				●			
Dialog Enhance				●			

The parameters that can be set are different for each listening mode.

* The surround given here refers to basic surround modes and consists of Dolby Pro Logic, Dolby Digital, DTS, MPEG, etc.

** +Action and +Musical refers to Dolby Digital Action, Dolby Digital Musical, DTS Action, DTS Musical, MPEG Action, MPEG Musical, Dolby Pro Logic Action, and Dolby Pro Logic Musical.

Preference

4. Preference menu

This menu provides settings for you to customize certain functions of the DTR-9.1 as you wish.

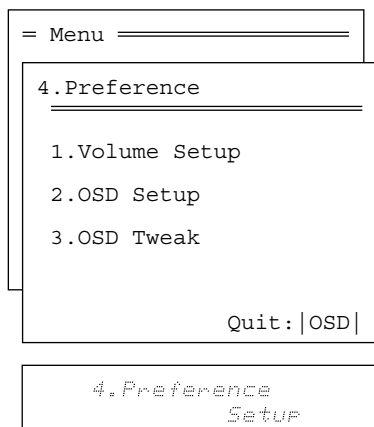

4-1. Volume Setup sub-menu

This sub-menu allows you to make various settings concerning the volume control of the DTR-9.1.

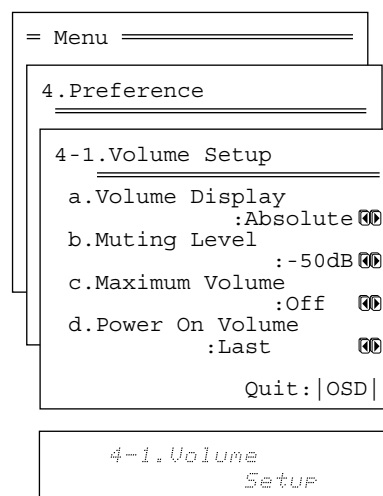

a. Volume Display

You can choose from two ways of displaying the volume setting on screen.

Absolute: This displays the volume with a minimum of min (0) for no sound and a maximum of max (100). As a reference, the volume setting of Ref (82) is used as the 0 -decibel for the relative display method.

Relative: This displays the volume as a decibel value on a scale with a designated reference point that is displayed as 0, which equals the volume setting of 82 for the absolute display method. With this display method, the minimum value is -, the next highest is -81, and the maximum value is +18.

b. Muting Level

This sets the attenuation level during playback when the Muting button is pressed on the remote controller. This can be set between -, -50 and -10 decibels in 10-decibel increments.

c. Maximum Volume

This sets a maximum limit for the master volume to reduce the chance of any components becoming damaged from accidental increases to the volume. For the absolute volume display method, this can be set between 50 and 90. For the relative volume display method, this can be set between -32 and +17 decibels.

d. Power On Volume

This sets a designated volume setting for the DTR-9.1 to be set every time that the power is turned on. This prevents the DTR-9.1 from being turned on while it is set to an extremely high volume and suddenly output very loud sounds. For the absolute volume display method, this can be set between 0 and 99. For the relative volume display method, this can be set between - and +18 decibels. If you do not mind having the DTR-9.1 turned on with its current volume setting, set this to "Last Valid."

Preference

4-2. OSD Setup sub-menu

This sub-menu allows you to customize the OSD menu to display in the manner you desire.

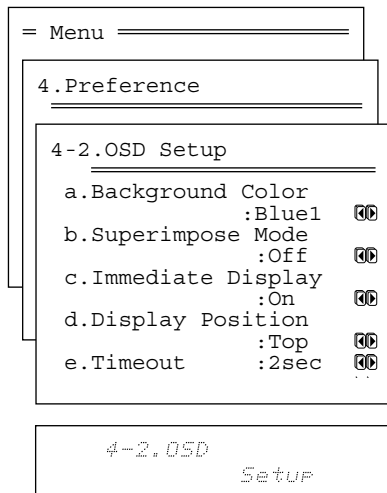

a. Background Color

Select either Blue1, Blue2, Green1, Green2, Magenta, Red1, or Red2 as the background color while the OSD menu is displayed.

b. Superimpose

Off: Select to have the OSD menu displayed on the selected background color.

Normal: Select to have the OSD menu superimposed over the current video if one is displayed or on the selected background color if there is no video signal.

Black: Select to have the OSD menu displayed on a black background at all times.

c. Immediate Display

On: Select this to have the screen immediately display certain operations as you perform them and maintain the display for a set amount of time after you are finished. For example, if you change the volume, the volume level will appear on the screen as it is changed.

Off: Select this to turn off the immediate display of operations.



Note:

The name that you input at the Character Input sub-menu (page 41) will not be reflected by the immediate display displayed when the input source is changed. For example, if your second DVD player is connected to VIDEO 5 and you change its name to "DVD-2," when it is selected as the input source, the immediate display still reads "VIDEO 5."

d. Display Position

Use this setting to select the position of the immediate display that appears when certain operations are performed. You can position the immediate display at any of ten different levels ranging from the top all the way to the bottom.

e. Timeout

Use this setting to select the amount of time the immediate display remains after the operation is completed. You can have the immediate display remain for 2, 3, 4, or 5 seconds.

4-3. OSD Tweak

This setting allows you to adjust the position of the OSD menu as it is displayed on your screen. Depending on the monitor used, there may be cases where the OSD menu is not displayed in the center and parts of the menu are cut off. To adjust the position of the OSD menu, simply press the cursor buttons to inch the menu to position you desire.

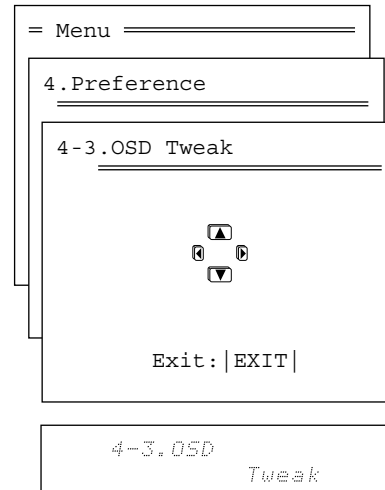

Zone2 OSD Setup

5. Zone2 OSD Setup menu

The settings for this menu are the same as those for the OSD Setup sub-menu of the Preference menu. Refer to the OSD Setup sub-menu for an explanation of the settings in this menu.

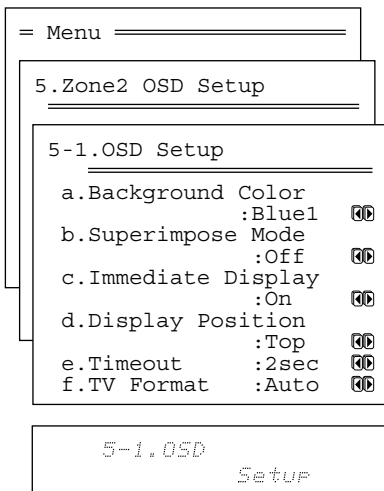
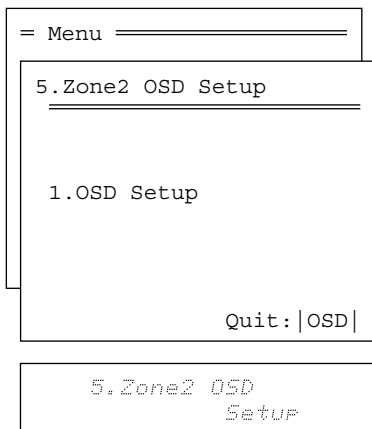

Note:
The relationship between the OSD menu for the main zone and remote zone (Zone 2)

The DTR-9.1 cannot output the OSD menu for both the main and remote zones simultaneously. For example, if an input source with no image is selected at the main zone (only the background color is displayed on the television screen) and the Zone 2 input source is changed, then the display at the main zone changes from the background color to a display with no image and the display at Zone 2 changes to the OSD menu (Immediate Display). This is not a malfunction. To prevent this, change the c. Immediate Display setting for the 5-1. OSD Setup sub-menu to "OFF."

The default setting for the c. Immediate Display setting of the 5-1. OSD Setup sub-menu is "OFF."

About

6. About menu

This menu consists of sub-menus that allow you to lock the controls of the DTR-9.1 and display its software version.

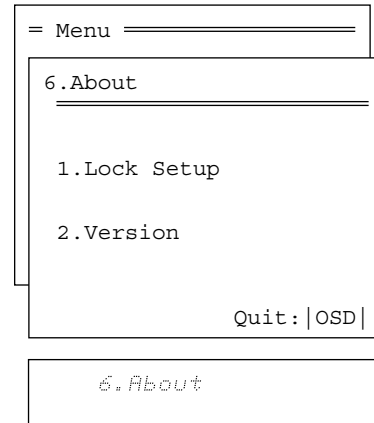

6-1. Lock Setup sub-menu

When "Locked" is selected for this setting, it prevents all settings in the OSD menu from being changed. This makes sure that the time-consuming settings that have been set are not changed by mistake. The default setting is "Unlocked."

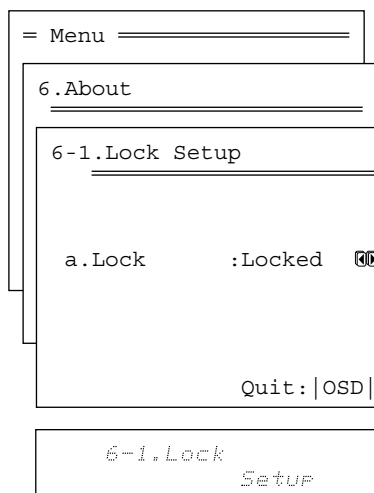

6-2. Version

This displays the version number of the microcomputer currently installed in your DTR-9.1.

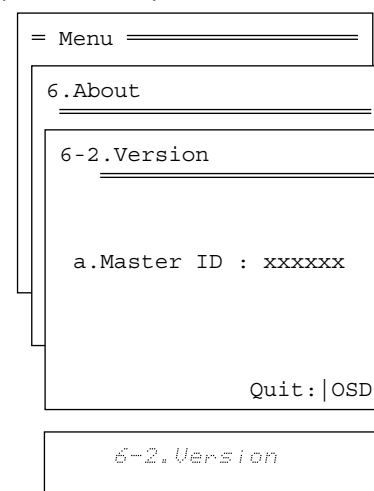

Enjoying music or videos in the remote zone

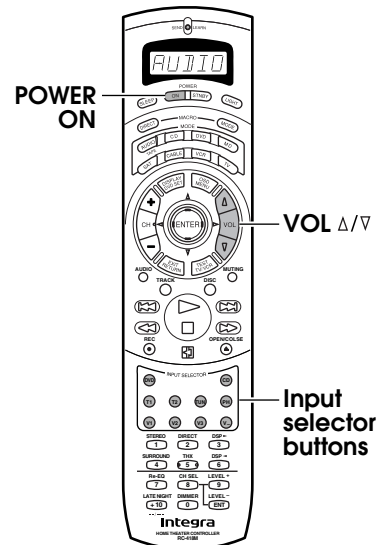
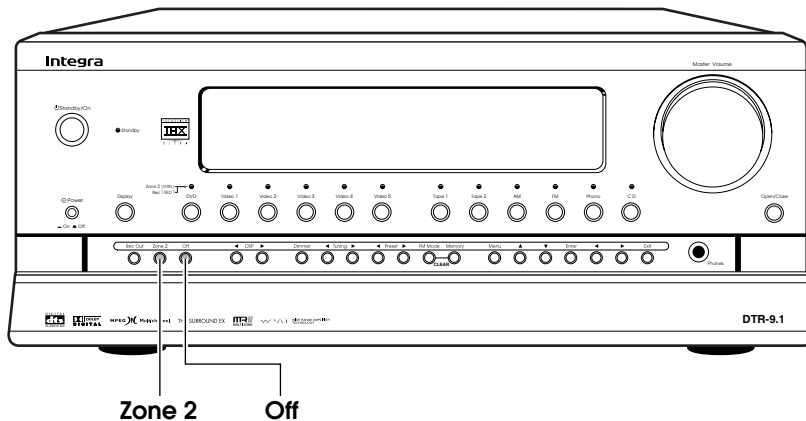

Controlling the DTR-9.1 from the remote zone

1. Aiming at the remote sensor, press the **POWER ON** button on the remote controller.

Note:

Be aware that if you start using the system in the remote zone (Zone 2) while a recording is going on in the main zone, the recording is aborted.

2. Press the appropriate input selector button on the remote controller to select the desired source.
3. Adjust the volume on the power amplifier to the desired level.

Controlling the DTR-9.1 without the remote controller

1. Press the Zone 2 button on the DTR-9.1.
2. Select a source.

After pressing the Zone 2 button, you must press an input source button within 8 seconds. To select the same source as that selected for the main zone, press the Zone 2 button twice in succession. The indicator above the selected input source will light green. Adjust the volume in the remote zone as desired.

Ex.: When the Zone 2 button is pressed twice

```
Zone2 Selector
:SOURCE
```

Ex.: When the Zone 2 button and then VIDEO 4 button are pressed

```
Zone2 Selector
:VIDEO4
```

Notes:

- If the Zone 2 button was pressed twice so that the same source is being played in the main and remote zones, then changing the input source in the main zone also changes the input source for the remote zone.
- In the remote zone, you can only play the source in the 2-channel mode. You cannot play the source in the remote zone in the surround mode.
- If the Rec Out button is pressed in the main room while someone is using the system in the remote zone, the Zone 2 function will be deactivated and the source will turn off in the remote zone.
- The Zone 2 terminal is an analog output. Digital signals are not output. If no sound is heard from the selected input source, check if the component is connected to the analog inputs.
- Please note that some third-party multi-room system components may not be fully compatible with the Integra multi-room system components.
- If you are not using the system in the remote zone, always press the Zone 2 button and then the Off button to turn the Zone 2 function off.

Listening to Radio Broadcasts

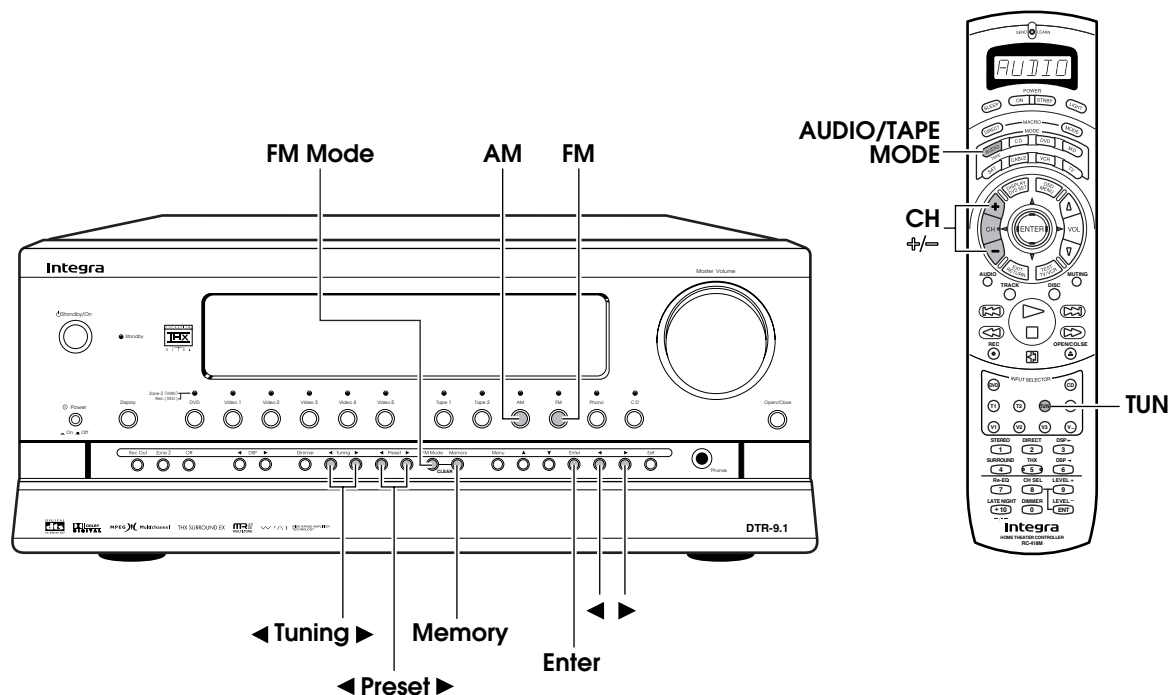

Listening to FM/AM Radio Stations

One of the features of the DTR-9.1 that is most frequently used is its ability to play FM and AM broadcast radio stations. The DTR-9.1 provides a number of listening modes perfect for listening to the radio and getting the most out of your audio system. Also, by presetting radio stations that you listen to frequently, you can use the PRESET buttons on the front panel to go to them automatically.

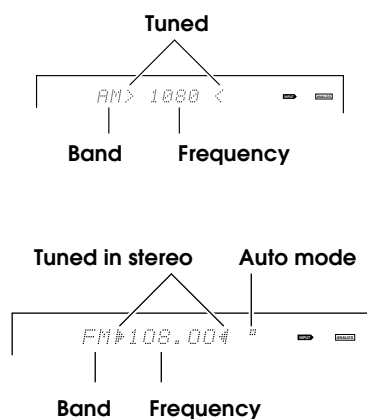

Tuning into a radio station

1. Press either the AM or FM input source button.
2. Using the ◀ and ▶ Tuning buttons on the front panel, tune into the station you desire.

When you tune into a radio station, > < surrounds the displayed frequency. If you tune into an FM station in stereo, then ▶ ◀ surrounds the displayed frequency. If the signal is weak, it may be impossible to tune into the station in stereo. In such a case, press the FM Mode button under the cover on the front panel. "Mono" appears for a few seconds under the frequency in the front display. To return to stereo, press the FM Mode button again. "Auto" appears for a few seconds and then "ST" appears to the right of the frequency. Some inter-station noise may be heard, but the sound will not cut in and out as it would if stereo was selected.

- The tuner frequency changes in 50-kHz increments for FM and 10-kHz increments for AM.
- When FM is selected, you can use the auto-search feature by pressing and holding down one of the TUNING buttons. The tuner frequency will search in the direction of the button pressed for the next station that can be tuned into in stereo.

Listening to Radio Broadcasts

Presetting a radio station

1. Tune into the radio station you desire (see "Tuning into a radio station" above).

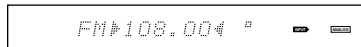

2. Press the Memory button on the front panel.

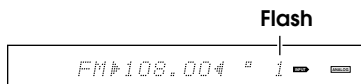

3. Using the ◀ or ▶ cursor buttons, select a preset number (from 1 to 40) to assign the station to be preset.

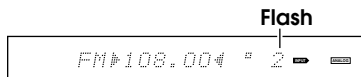

4. Press the Enter button again to finalize the procedure.

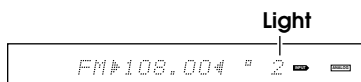

This programs the radio station as a preset radio station.

- Up to 40 stations can be stored in memory as preset radio stations.
- Using the OSD Menu, you can enter names to each preset radio station (see page 41).

Selecting a preset radio station

1. Press either the AM or FM input source button. (or press the TUN button on the remote controller when in AUDIO mode)
2. Press the ◀ and ▶ Preset buttons on the front panel (or the CH+ or CH- buttons on the remote controller) to scroll through the preset radio stations until you reach the one you want.

Erasing a preset radio station

1. Using the ◀ and ▶ Preset buttons, select the preset radio station that you want erase (see above).
2. Press and hold down the Memory button while you press the FM Mode button.

This erases the selected preset station.



Enjoying music or videos with the DTR-9.1

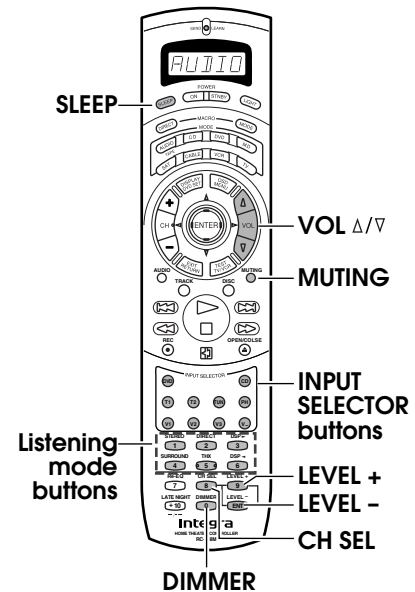
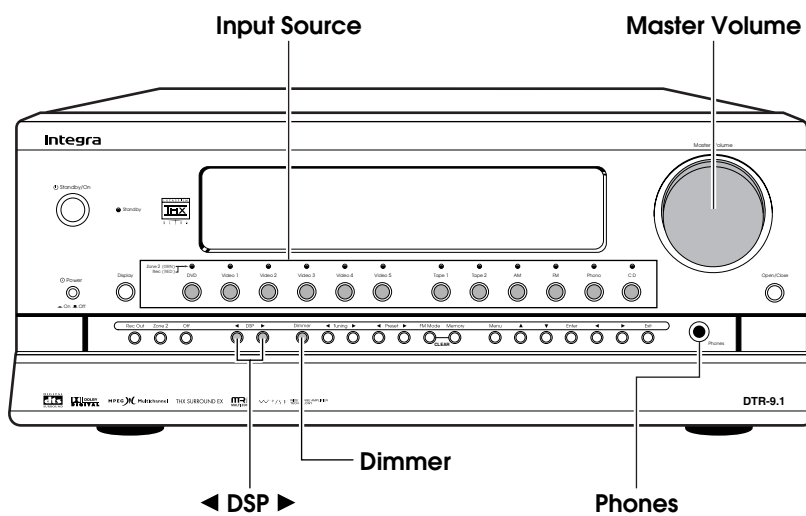

Though the DTR-9.1 is often used to listen to the radio, it does not show you its true ability until it is used to play music or watch videos, LDs, DVDs, and the like. The DTR-9.1 has the latest in state-of-the-art features to play back today's acoustic technologies with the utmost in fidelity and power. From a two-speaker system to a seven-speaker system, you are assured a sound space that you can always enjoy.

Selecting an input source

Before you can listen to any input media, you must first select the input source at the DTR-9.1. This tells it which input source to output to the speakers and monitor.

To select an input source, simply press the button on the front panel (or on the remote controller) that corresponds to the input source you want.

After you have selected the input source, simply turn on the corresponding component and play the media.

Adjusting the volume

Adjusting the main volume adjust the volume level output from all the speakers connected to the DTR-9.1 together. If headphones are connected, this also adjusts the volume heard from the headphone. To adjust the volume, either press the VOL Δ/∇ buttons on the remote controller or turn the MASTER VOLUME dial. To increase the volume, turn the dial to the right; to decrease the volume, turn the dial to the left.

Changing the listening mode

To change the listening mode during playback, press the ◀ and ▶ DSP buttons on the front panel or the listening mode buttons on the remote controller (see page 57).

Listening with headphones

To listen with headphones, plug a pair headphones with a standard stereo plug into the PHONES jack on the DTR-9.1 front panel.

When you connect headphones, the unit will enter STEREO mode automatically and no sound will be heard from the speakers.

Using the many features of the DTR-9.1

Outputting from different input source:

You can have the DTR-9.1 output the audio of one input source through the speakers while the video of another input source is output to the monitor (see "2-3. Video Setup sub-menu" on page 36).

Assigning names to input sources:

You can enter a name for each input source so that when the source is selected the name of that source is displayed in the front display of the DTR-9.1 (see "2-7. Character Input sub-menu" on page 41).

Temporarily changing the speaker output levels:

To change the individual speaker volumes temporarily, use the remote controller and follow the procedure given below. Note that the calibration settings will return to the original settings when the DTR-9.1 is put in standby.

1. Press the CH SEL button and select the desired speaker.
2. Press the LEVEL + or - button to adjust the volume level.

Enjoying music or videos with the DTR-9.1

Using the sleep time:

To set the sleep timer, press the SLEEP button on the remote controller and then set the time that you want the DTR-9.1 to enter the standby state (see page 57).

Temporarily turning off the sound:

To turn off the sound momentarily, such as when interrupted by a phone call, press the MUTING button on the remote controller (see page 57).

Adjusting the bass and treble:

You can adjust the bass and treble levels at the Sound Effect sub-menu of the OSD menu: Input Setup → Sound Effect (see page 40).

Adjusting the brightness of the front display:

You can adjust the brightness of the front display of the DTR-9.1 with DIMMER button on the remote controller or on the DTR-9.1 front panel (see page 57).

If one of the messages shown below appears

If one of the messages shown below appears in the front display, it is telling you that the operation you are trying to perform is not possible for the reason given in the message.

Not available
with HP in

The operation is not allowed because headphones are plugged into the DTR-9.1.

Not available
in Multi Ch

The operation is not allowed because the selected input source is set for multichannel input.

Not available
in this Sp.Cfg

The operation is not allowed by the current speaker configuration.

Not available
other than DD

No setting other than Dolby Digital can be set.

Enjoying the multichannel output

Before you can use a component with multichannel output, you must first select "Yes" for the Multichannel setting in the OSD menu for that input source: Input Setup → Multichannel Setup (see page 36).

1. Press the input source button for the component with multichannel output connected to the MULTI CHANNEL INPUT on the rear of the DTR-9.1.
2. Turn on the connected component and start playing the desired media.
3. If necessary, press the CH SEL button on the remote controller to select an individual speaker. Then press the LEVEL + or - button to adjust the output level as desired.

Adjust the speaker output levels so that you can hear the same sound level from each speaker at the listening position. For the front right, front left, center, surround right, surround left, surround back right and surround back left speakers, the output levels can be adjusted between -12 to +12 decibels. The subwoofer can be adjusted between -30 and +10 decibels.

4. Adjust the volume with the MASTER VOLUME dial or the VOL Δ/∇ buttons on the remote controller.

Recording a source

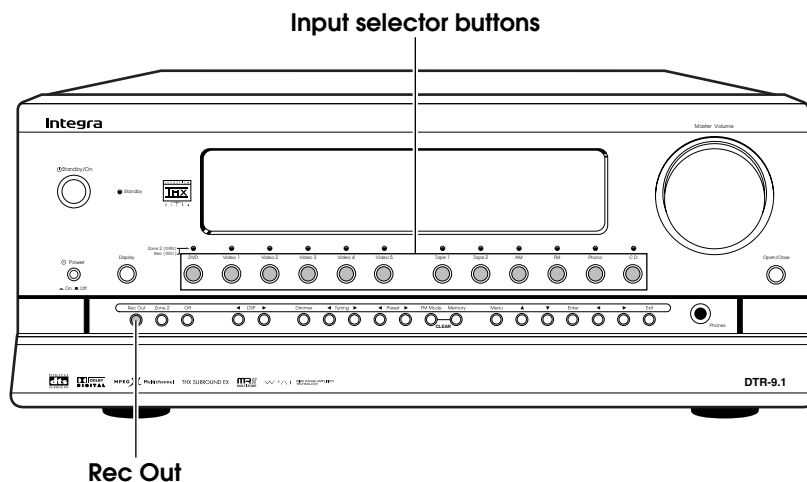

Of course the DTR-9.1 can also be used to record an input source media. This allows you to make copies of the music or videos you like, copy them from one type of media to another, or even record what is being broadcast on television or radio. Be aware that the Rec Out and Zone 2 buttons use the same circuit so that you cannot make recording and output to the remote zone (Zone 2) at the same time.

To record the input source signal you are currently watching or listening to

This method outputs to the audio and video outputs the currently selected input source signal. This method allows you to a signal while you are actually listening to or watching it.

1. Select the input source to record by pressing the corresponding input selector button.

The input source is now selected and you may watch or listen to it as desired.

2. Press the Rec Out button twice within 8 seconds.

Pressing the Rec Out button twice outputs the currently selected input source signal to the TAPE 1 OUT, TAPE 2 OUT, VIDEO 1 OUT, and VIDEO 2 OUT outputs for recording. The indicator above the selected input source lights red.

3. Start recording at the recording component as desired.

To confirm the settings, press the Rec Out button. The current settings will appear for 8 seconds in the front display.

```
Rec Selector  
:SOURCE OPT3
```

Notes:

- If you change the input source during recording, you will record the signals from the newly selected input source.
- You cannot record the surround effects.
- Digital signals input to the DIGITAL INPUT (COAXIAL) and DIGITAL INPUT (OPTICAL) inputs will be output to the DIGITAL OUTPUT (COAXIAL) and DIGITAL OUTPUT (OPTICAL) outputs.
- Digital input signals are only output to the digital outputs and analog input signals are only output from the analog outputs. There is no conversion from digital to analog or vice versa. When connecting CD players and other digital components, do not connect only the digital terminals, but the analog ones as well.
- There are some restrictions on recording digital signals. When making digital recordings, consult the instruction manual that came with your digital recording equipment (e.g., MD recorder or DAT deck) to know what restrictions are imposed.
- You cannot record the source connected to the MULTI CHANNEL INPUT connector.

Recording a source

To record an input source signal different from that you are currently watching or listening to

This method outputs to the audio and video outputs the signal from the input source that you select here. This allows you to record an input source signal different from that that you are listening to or watching at the time of recording.

1. Press the **Rec Out** button.
2. Within 8 seconds, press the input source selector button of the input source signal that you wish to record.

The indicator above the selected input source will light red. The signal from the selected input source will now be output to the TAPE 1 OUT, TAPE 2 OUT, VIDEO 1 OUT, and VIDEO 2 OUT outputs for recording.

3. Start recording at the recording component as desired.

To confirm the settings, press the Rec Out button. The current settings will appear for 8 seconds in the front display.

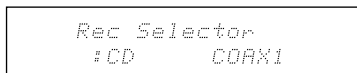

Rec Selector
:CD COAX1

Notes:

- Be aware that the remote (Zone 2) and recording (Rec Out) outputs use the same circuit and therefore can be used at the same time.
- You cannot record the surround effects.
- Digital signals input to the DIGITAL INPUT (COAXIAL) and DIGITAL INPUT (OPTICAL) inputs will be output to the DIGITAL OUTPUT (COAXIAL) and DIGITAL OUTPUT (OPTICAL) outputs.
- There are some restrictions on recording digital signals. When making digital recordings, consult the instruction manual that came with your digital recording equipment (e.g., MD recorder or DAT deck) to know what restrictions are imposed.
- You cannot record the source connected to the MULTI CHANNEL INPUT connector.

Recording the video from one source and the audio from another

You can add the sound from one source to the video of another source to make your own video recordings.

Below is an example of recording the sound from a compact disc player connected to CD IN and the video from a video camera connected to VIDEO 5 IN to video cassette tape in a video cassette recorder connected to the VIDEO 1 OUT jack.

1. Press the **CD** input source button.
2. Set "VIDEO 5" for the Video setting in the Video Setup sub-menu of the OSD menu: **Input Setup → Video Setup → Video**.
3. Insert a CD in the CD player and insert a tape in the video camera connected to the VIDEO 5 IN.
4. Insert a video tape for recording in the video cassette recorder connected to VIDEO 1 OUT.
5. Press the **Rec Out** button twice within 8 seconds.

The indicator above the CD input source button lights red. Now "CD" has been selected as the audio input source and "VIDEO 5" as the video input source.



CD Stereo

6. Start recording on the video cassette recorder and start playing at the CD player and video camera as desired.

Notes:

- If you change the input source during recording, you will record the audio signals from the newly selected input source and the video signals assigned to that input source.
- You cannot record the surround effects.

Using remote controller

Overview

The RC-418M remote controller is a useful tool to help you operate the components of your home theater. To do so, first press the MODE button that corresponds to the device you wish to control. At this time, the display on the remote controller will change to show the component that is selected. Then simply press the desired operation button and the component will operate accordingly. For example, if you wish to select the CD input source at the DTR-9.1 with the remote controller, first press the AUDIO/TAPE MODE button to select the DTR-9.1 ("AUDIO" will appear on the display) and then press the CD (INPUT SELECTOR) button.

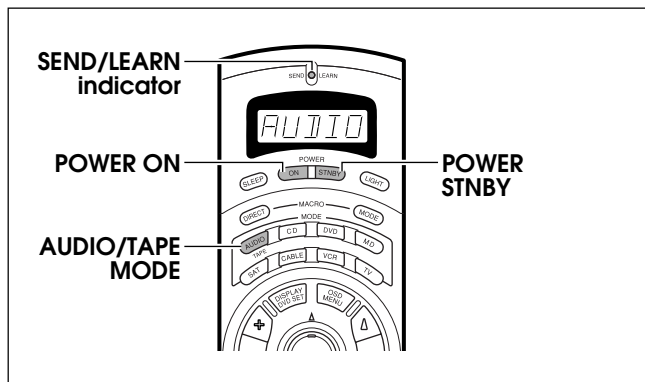

Using the remote controller to control each device

In order to use the remote controller, you must first turn on the POWER switch at the DTR-9.1 so that it enters standby mode.

1. Press the AUDIO/TAPE MODE button.

"AUDIO" appears in the remote controller display.

2. Press the POWER ON button to turn on the DTR-9.1 and press the POWER STNBY button to put it back in the standby mode.

When you press the POWER STNBY button on the remote controller, it puts the DTR-9.1 in the standby state but does not turn it completely off.

SEND/LEARN indicator

This indicator acts as a guide when commands are programmed into or sent by the remote controller. It also warns the user when an error is made or battery power is low.

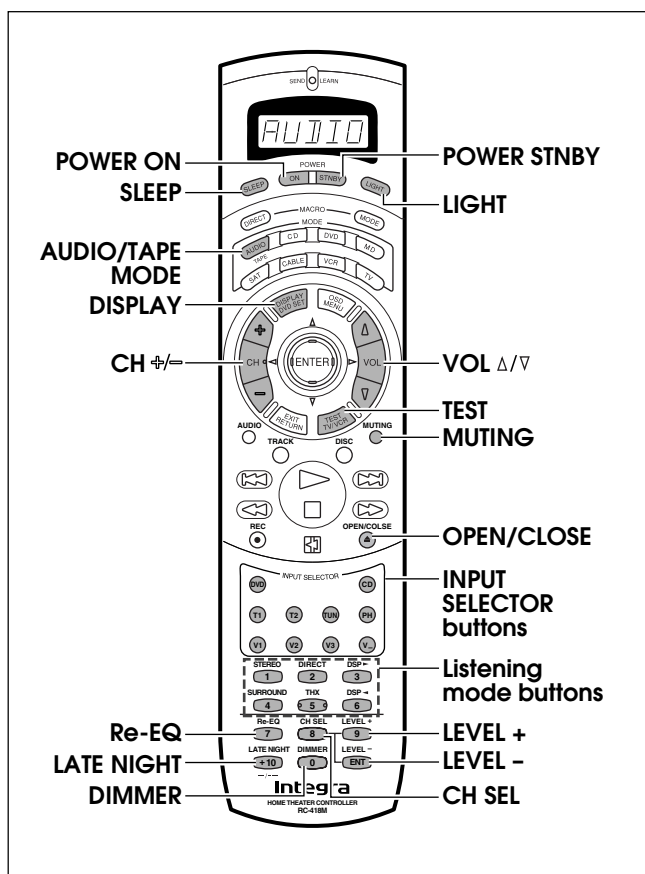

Controlling the DTR-9.1

If "AUDIO" is already appears in the display, proceed to step 2.

1. Press the AUDIO/TAPE MODE button.

"AUDIO" appears in the remote controller display.

2. Press the desired operation button. The buttons shaded in the figure to the left are the operation buttons that can used to control the DTR-9.1.

Using remote controller

LIGHT: Illuminates the buttons

SLEEP: Sets the sleep function

- The SLEEP buttons enables you to set the DTR-9.1 to turn off automatically after a specified time period. If you press it once, the DTR-9.1 will turn off after 90 minutes. Each time it is pressed thereafter, the remaining time until the DTR-9.1 turns off decreases by 10 minutes. While the sleep function is enabled, you can press the SLEEP button to see how much time is left. To cancel the sleep function, press the SLEEP button when the time displayed is less than 10 minutes.

POWER ON/STNBY: Turns on the DTR-9.1 or puts it in standby

DISPLAY: Changes the display

- Same as the DISPLAY button on front panel of the DTR-9.1.

VOL Δ/∇ : Adjusts the volume

Volume -26

CH +/-: Selects the tuner preset stations

TEST: Outputs a test tone for setting speaker levels

- Use this button in conjunction with the LEVEL +/- and CH SEL buttons to calibrate the speakers levels without entering the OSD Menu. When TEST button is pressed, the test noise (pink noise) is output. Use the LEVEL +/- buttons to increase or decrease the sound level. Use the CH SEL button to change from speaker to speaker. For a more detailed explanation of how to calibrate the speaker levels, see page 32.

MUTING: Activates the mute function

Muting

- This button turns down the playback sound immediately. This can be useful, for example, when you receive a telephone call while listening to music or another source. When pressed, "Muting" is displayed on the DTR-9.1. Press the MUTING button again to turn the sound back on.
- The DTR-9.1 allows you to set the volume when the MUTING button is pressed. This can be done at the OSD menu: Preference → Volume Setup → b. Muting Level (See page 46)

OPEN/CLOSE: Open and close the front door that covers the lower buttons.

INPUT SELECTOR: Selects an input source

- Same as the input selector buttons on front panel of the DTR-9.1.

Re-EQ: Depending on the listening mode, you can either turn the cinema re-equalization function on or off, or you can select "Re-EQ," "Academy," or "Off"

- The re-equalization function takes the edginess or "brightness" out of your home cinema sound to compensate for the fact that sound mixed for theaters may sound too bright when played back through speakers in the home environment.

LATE NIGHT: Sets "High," "Low," or "Off" for the late night function

- Cinema sound has a vast dynamic range; therefore, to hear the quieter sounds such as human conversations, they must be played back at larger volumes. When this parameter is set to "High" or "Low," the dynamic range of the sound is narrowed down to allow you to easily hear minute sounds at low volumes. This function is especially useful if you wish to play a movie at low volumes during the nighttime.

Notes:

- The depth of the Late Night effect is determined by Dolby Digital software. Some sounds may produce no or little effect.
- The Late Night function is effective only on Dolby Digital encoded software.

CH SEL: Selects a speaker for changing the speaker output level

- See TEST button above.

DIMMER: Adjusts the display brightness

- There are four settings available: normal, dark, very dark, and off.

LEVEL +: Increases the speaker level

- See TEST button above.

LEVEL -: Decreases the speaker level

- See TEST button above.

Listening mode buttons

STEREO: Changes the listening mode directly to stereo

- This button automatically changes the listening mode of the current input source signal to the stereo listening mode. The setting in the OSD Menu will also change accordingly.

SURROUND: Changes the listening mode directly to a plain surround mode.

- This button automatically changes the listening mode of the current input source signal to its corresponding surround mode (e.g., Dolby Pro Logic, Dolby Digital, DTS, and MPEG). The setting in the OSD Menu will also change accordingly.

DIRECT: Changes the listening mode directly to direct

- This button automatically changes the listening mode of the current input source signal to the direct listening mode. The setting in the OSD Menu will also change accordingly.

THX: Changes the listening mode directly to the THX Cinema mode

- If the THX mode was already selected, then this buttons changes the THX Surround EX setting as follows:

Auto → On → Off

Auto: For THX Surround EX encoded sources, the listening mode is automatically set to THX Surround EX, and for other input sources, the listening mode is set to THX Cinema.

On: Regardless of the input source signal, the listening mode is set to THX Surround EX.

Off: Regardless if the input source signal is THX Surround EX, the listening mode is set to THX Cinema.

For more information on THX Surround EX, refer to pages 38-39.

DSP $\blacktriangleleft/\blacktriangleright$: Sets a new listening mode for the current input source signal

- Same as the DSP buttons on front panel of the DTR-9.1.

Using remote controller

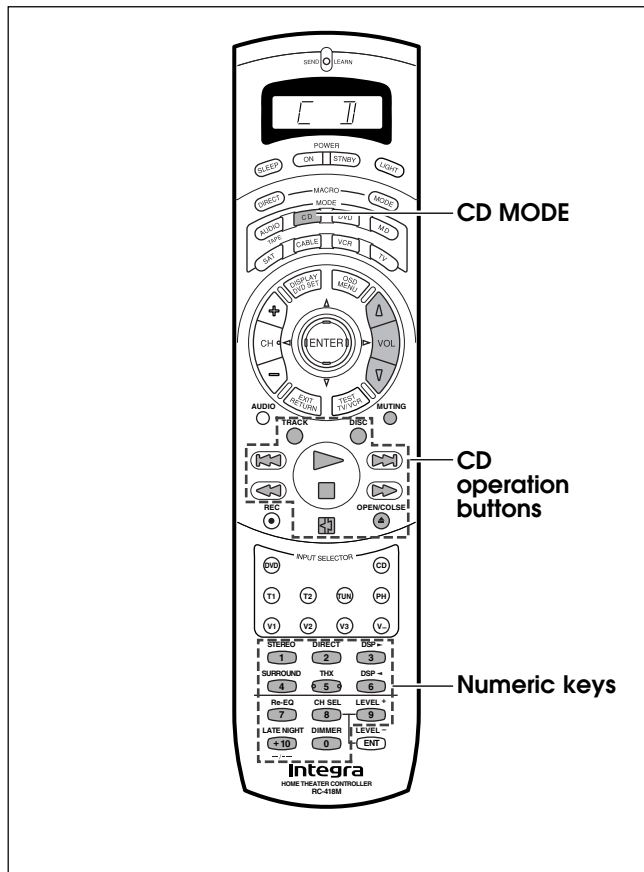

Controlling an Integra CD player

The RI connector of the Integra compact disc player must be connected to the DTR-9.1 (see page 15).

1. Press the CD MODE button.

"CD" appears in the remote controller display.

2. Press the desired operation button. The buttons shaded in the figure to the left are the operation buttons that can be used to control an Integra compact disc player.

TRACK: Selects a track

DISC: Selects a disk in the CD changer

⏮: Track Down

⏭: Track Up

▶: Play

◻: Stop

⏪: Fast Reverse

⏩: Fast Forward

⏸: Pause

OPEN/CLOSE ▲: Open/close the disc tray

0, 1 to 9, +10: Numeric keys

You may also use the following buttons:

VOL Δ/V: Adjusts the volume at the DTR-9.1

MUTING: Activates the muting function at the DTR-9.1

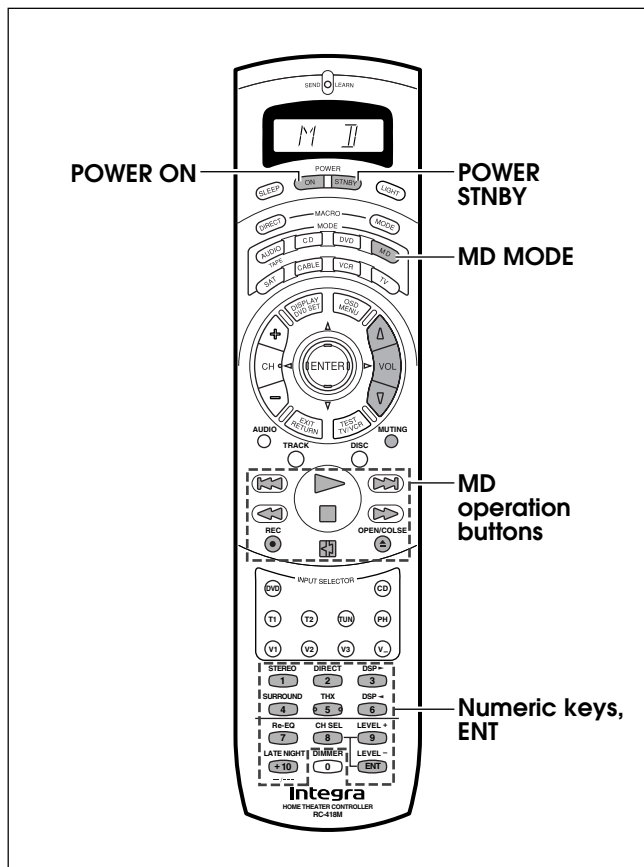

Controlling an Integra MD recorder

Make sure that you point the remote controller toward the sensor on the Integra MD recorder.

1. Press the MD MODE button.

"MD" appears in the remote controller display.

2. Press the desired operation button. The buttons shaded in the figure to the left are the operation buttons that can be used to control an Integra mini disc player.

POWER ON/STNBY: Turns the mini disc player on and off

⏮: Track Down

⏭: Track Up

▶: Play

◻: Stop

⏪: Fast Reverse

⏩: Fast Forward

REC ●: Record

⏸: Pause

▲: Eject the disc

1 to 9, +10: Numeric keys

ENT: Enters the settings

You may also use the following buttons:

VOL Δ/V: Adjusts the volume at the DTR-9.1

MUTING: Activates the muting function at the DTR-9.1

Using remote controller

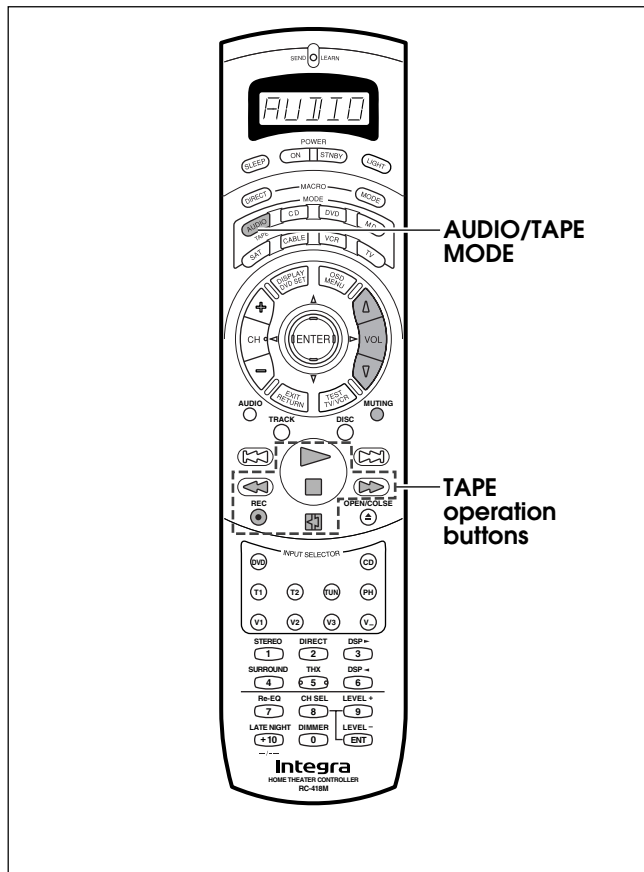

Controlling an Integra cassette tape deck

The **RI** connector of the Integra cassette tape deck must be connected to the DTR-9.1 (see page 15).

1. Press the **AUDIO/TAPE MODE** button.

"AUDIO" appears in the remote controller display.

2. Press the desired operation button. The buttons shaded in the figure to the left are the operation buttons that can be used to control an Integra cassette tape player.

▷: Play

◻: Stop

◀◀: Fast Rewind

▶▶: Fast Forward

REC ●: Record

◻: Reverse playback

You may also use the following buttons:

VOL Δ/∇: Adjusts the volume at the DTR-9.1

MUTING: Activates the muting function at the DTR-9.1

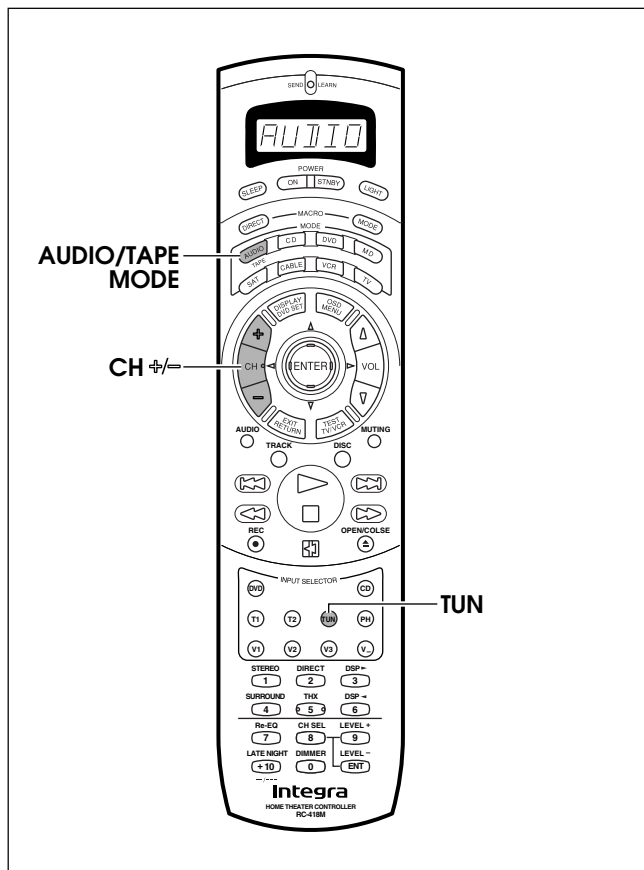

Calling up a preset radio station

1. Press the **AUDIO/TAPE MODE** button.

"AUDIO" appears in the remote controller display.

2. Press the **TUN** input selector button.

"(TUN)" appears in the remote controller display and momentarily and then "AUDIO" reappears.

3. Press the **CH +** or **-** button to select the desired preset station number.

Using remote controller

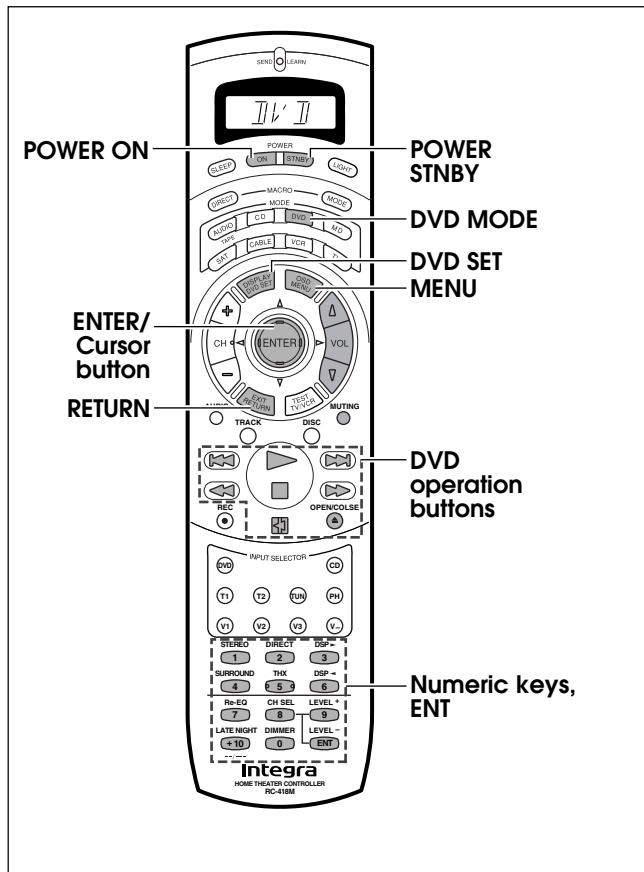

Controlling an Integra DVD player

Make sure that you point the remote controller toward the sensor on the Integra DVD player.

1. Press the DVD MODE button.

"DVD" appears in the remote controller display.

2. Press the desired operation button. The buttons shaded in the figure to the left are the operation buttons that can be used to control an Integra DVD player.

POWER ON/STNBY: Turns the DVD player on and off
DVD SET: Enters the DVD setup menu

DVD player on-screen buttons

MENU: Displays the menu

Δ/∇/◀/▶: Moves the cursor

ENTER: Confirms the selection

RETURN: Return buttons

DVD player buttons

⏮: Chapter/Track Down

⏭: Chapter/Track Up

▶: Play

⏹: Stop

⏪: Fast Reverse

⏩: Fast Forward

⏸: Pause

OPEN/CLOSE ▲: Open/close the disc tray

0, 1 to 9, +10: Numeric keys

ENT: Confirm

You may also use the following buttons:

VOL Δ/∇: Adjusts the volume at the DTR-9.1

MUTING: Activates the muting function at the DTR-9.1

Note:

The ENT button on the bottom right of the numeric keys has the same function as "ENTER" of the ENTER/cursor button.

SAT, CABLE, VCR, and TV MODE buttons

No preset codes are programmed into the SAT, CABLE, VCR, and TV MODE buttons. You can use these buttons to program the remote controller signals of other devices (see page 61).

You may use the following buttons:

VOL Δ/∇: Adjusts the volume at the DTR-9.1

MUTING: Activates the muting function at the DTR-9.1

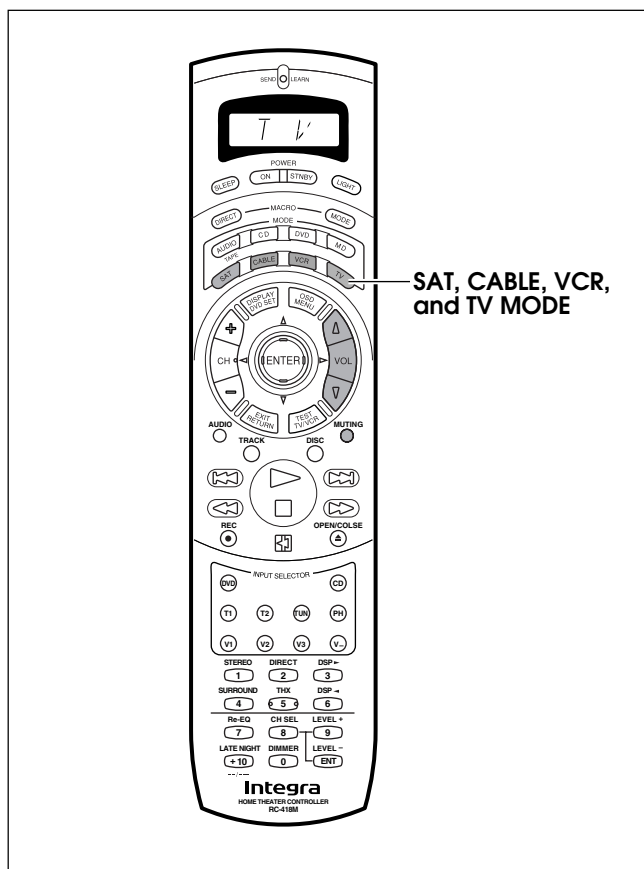

Programming the commands of remote controllers for other devices into the remote controller

The remote controller has two learning functions. One is a normal learning function that enables the remote controller to learn the codes from other remote controllers. The other is a macro learning function that enables you to program a series of operations into the remote controller so that they can all be performed at once by pressing one button.

Programming procedure

When programming the commands of another remote controller to the RC-418M remote controller, you must first decide under which MODE button you want the commands to be linked. In general, you will select the MODE button that corresponds to the component you are programming. For example, if you are programming the functions from a remote controller for a compact disc player, you would choose the CD MODE button. Then, by pressing the CD MODE button, the buttons on the RC-418M remote controller will change to the commands you program here to operate the compact disc player.

After programming which MODE button to use, you will then transfer the separate commands from the other remote controller over to the RC-418M remote controller one at a time. Each command is then programmed to a different button on the RC-418M remote controller. Any button is programmable for this step except for the eight MODE buttons (AUDIO, CD, DVD, MD, SAT, CABLE, VCR, and TV), the two MACRO buttons (DIRECT and MODE), and the LIGHT button.

Even after the commands have been memorized, keep your old remote controller in a safe place. If for some reason the commands are lost (e.g., when the batteries run down), it will be necessary to memorize them once again.

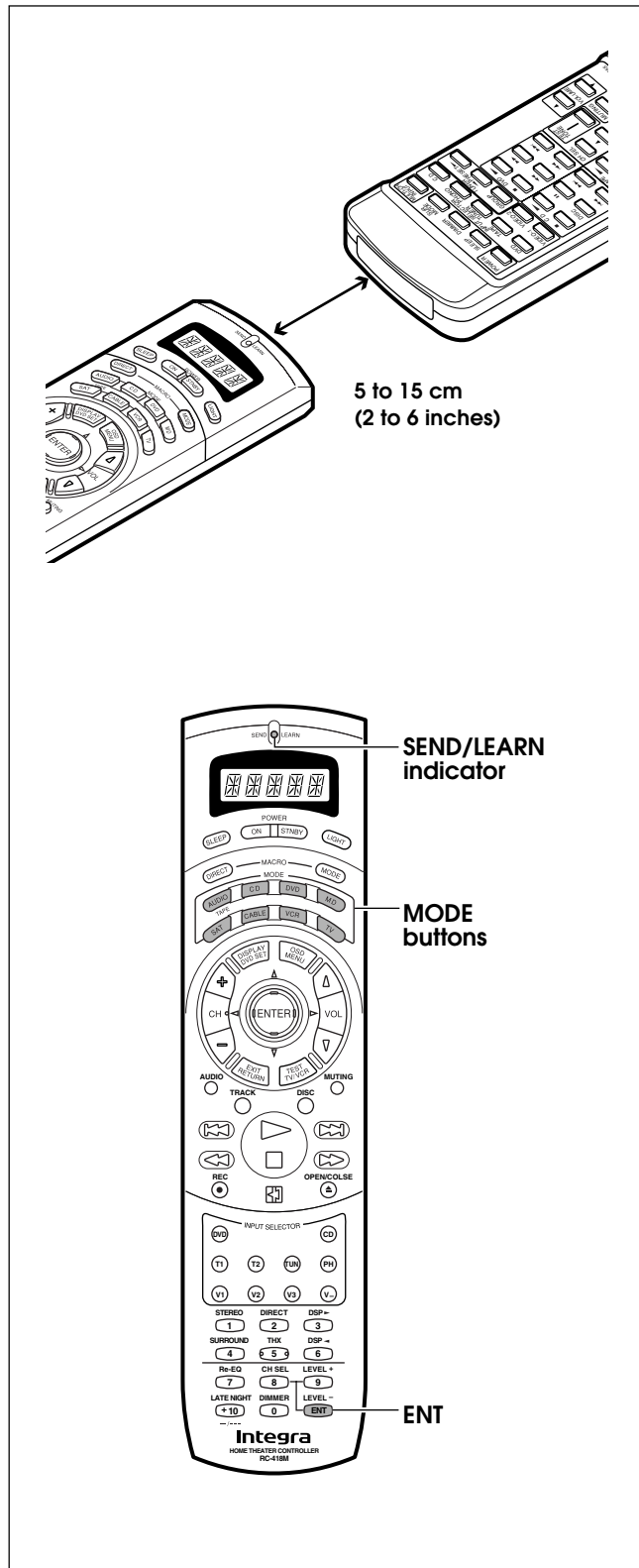

1. Place the remote controller and the remote controller for the other device facing each other at a distance of 5 to 15 cm (2 to 6 inches) apart.

2. While pressing and holding down the desired MODE button on the remote controller, press the ENT button and then release both buttons.

When you press and hold down the MODE button, the SEND/LEARN indicator lights. When you press the ENT button, the lamp turns off. When you release the buttons, the lamp lights again and "LEARN" appears in the display.

3. Press and release the button on the remote controller to which you want to transfer the next command.

You may select any button but the eleven ones indicated in the figure below. When you press the button, "RCV" appears in the display and the SEND/LEARN indicator turns off. When you release the button, the indicator lights again.

If you press the wrong button by mistake, press that same button again. The SEND/LEARN indicator flashes twice, "CLEAR" appears in the display, and the remote controller exits the programming mode.

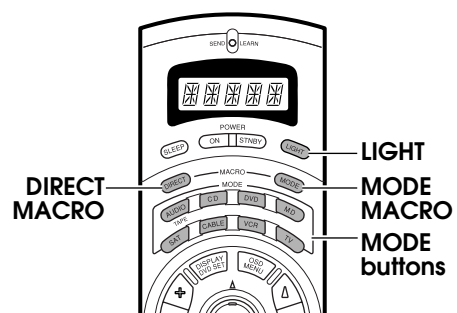

■ : Buttons that cannot be programmed.

Programming the commands of remote controllers for other devices into the remote controller

- 4. Press and hold down the button (that corresponds to the command you are programming) on the remote controller of the other device until the SEND/LEARN lamp on the remote controller flashes twice and "SAVED" appears in the display.**

After flashing twice, the SEND/LEARN indicator will light again and "LEARN" appears in the display.

- 5. Repeat Steps 3 and 4 to transfer all the commands you desire from the other remote controller and program them to buttons on the remote controller under the same MODE.**

Repeat Steps 2 through 4 to program commands to a different MODE (e.g., when programming from a different remote controller).

- 6. Press the MODE button that you pressed in step 2 to complete the programming.**
- 7. Operate the newly programmed buttons to make sure the learning function was performed properly.**

Notes:

- The remote controller codes for Integra compact disc players, cassette tape decks, DVD players, and mini disc recorder have already been programmed into buttons on the remote controller. You may, however, use these buttons to program the codes for other remote controllers. If you wish to restore the Integra preset codes after you program new codes, you must first erase the new codes (see page 63).
- The remote controller has 408 memory slots (8 modes x 51 buttons). Some remote controllers may have more commands that can be remembered by the remote controller. In such cases, it will be necessary for you to determine which commands are more important than others.
- If no button is pressed for more than 30 seconds during the programming, or if you perform an invalid operation during programming, the SEND/LEARN indicator flashes three times quickly, "ERROR" appears in the display, and the remote controller exits the programming mode. Resume from Step 2.
- If a failure occurs during programming, the SEND/LEARN indicator flashes three times quickly, "NG" appears in the display, and the remote controller exits the programming mode. Resume from Step 3.
- If a failure occurs five times in row during programming, "ERROR" appears in the display, and the remote controller exits the programming mode. Resume from Step 3.
- If you try to program beyond the learning capacity of the remote controller, the SEND/LEARN indicator flashes six times quickly, "FULL" appears in the display, and the remote controller exits the programming mode. Try programming under a different MODE button.
- When you want to program a command to a button to which you have already programmed a command, simply follow the same procedure given and programming for that button will be overwritten.
- The remote controller uses infrared rays to send its commands, as do most other remote controllers. Though most remote controller codes can be memorized by the remote controller, be aware that some remote controllers use a system that is quite different from the remote controller and therefore may not be able to be programmed.
- Some remote controllers have a single button that performs multiple functions (for example, the function may change each time the button is pressed). If this is the case, each function must be programmed to a separate button on the remote controller.
- Once you have transferred the commands from the other remote controller, refer to the instruction manual that came with that product for instructions on how to operate that product.
- Make sure both the remote controller and the other remote controller have new batteries. If either of them has batteries that are low, you may not be able to program the commands of the other remote controller properly into the remote controller.

See page 63 for how to erase the memorized commands from all buttons.

Programming the commands of remote controllers for other devices into the remote controller

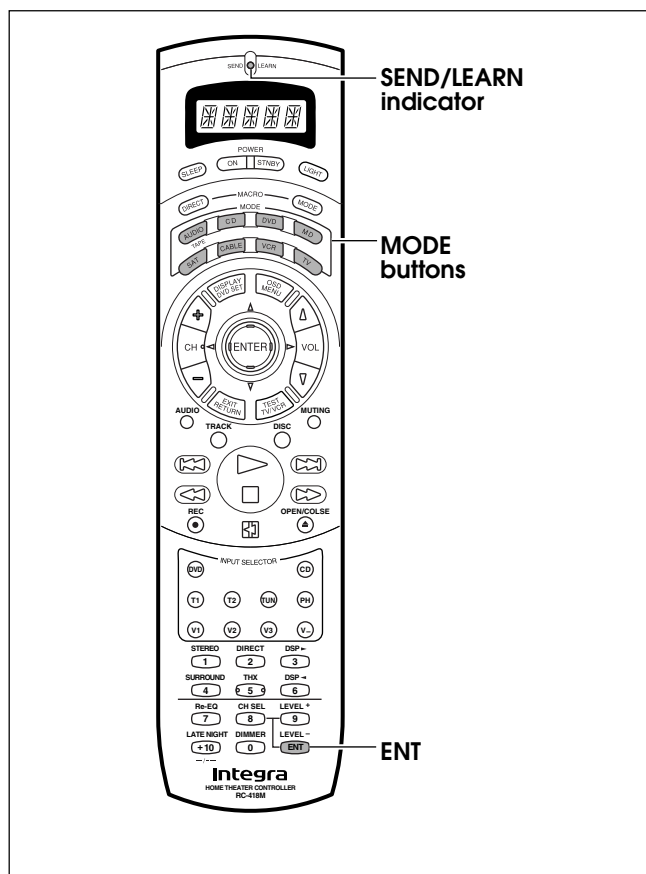

Erasing the programmed command from one button

You can only erase memorized commands and not preset ones.

1. Press and hold down the desired MODE button for the command, press the ENT button, and then release both buttons.

When you press the MODE button, the SEND/LEARN indicator lights and that mode appears in the display. When you press the ENT button, the lamp turns off. When you release the buttons, the lamp lights again and "LEARN" appears in the display.

2. Press and release the button for the command you wish to erase.

When you press the button, the SEND/LEARN indicator turns off and "RCV" appears in the display. When you release the button, the lamp lights again.

3. Press and release the same button again.

The SEND/LEARN lamp flashes twice slowly and "CLEAR" appears in the display. The memorized command is erased.

Note:

- If no button is pressed for more than 30 seconds during the programming, the SEND/LEARN indicator flashes three times quickly, "ERROR" appears in the display, and the remote controller exits the programming mode. Resume from Step 1.

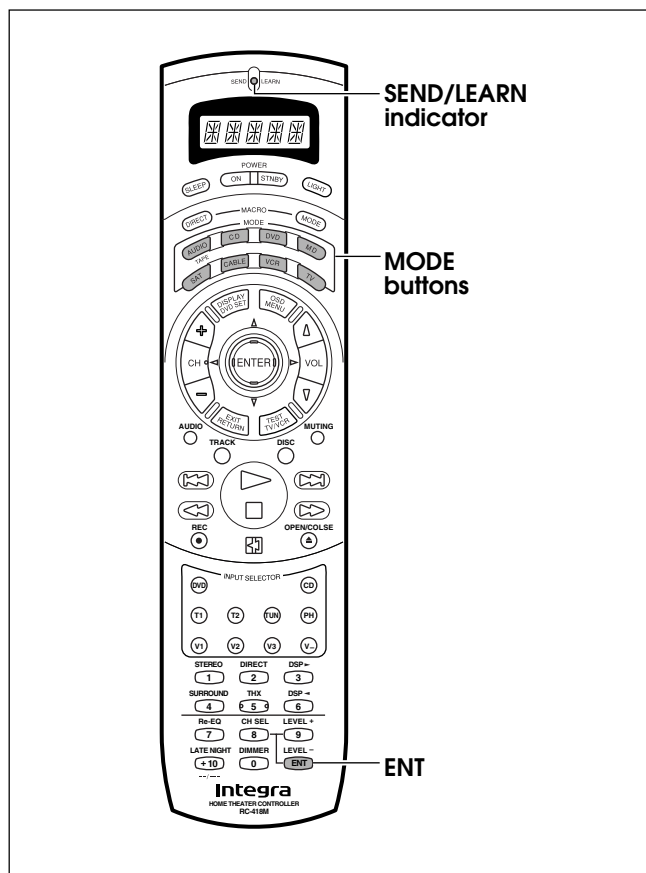

Erasing all the commands programmed under a MODE button

1. Press and hold down the desired MODE button, press the ENT button twice, and then release both buttons.

When you press the MODE button, the SEND/LEARN indicator lights and that mode appears in the display. When you press the ENT button, the lamp turns off. When you release the buttons, the lamp flashes twice slowly and then lights again.

2. Press and release the same MODE button again.

When you release the button, the SEND/LEARN indicator flashes twice slowly. This erases all the commands memorized to the MODE button.

Notes:

- If no button is pressed for more than 30 seconds during the programming, the SEND/LEARN indicator flashes three times quickly and the remote controller exits the programming mode. Resume from Step 1.
- If you perform an invalid operation during programming, the SEND/LEARN indicator flashes three times quickly, "ERROR" appears in the display, and the remote controller exits the programming mode. Resume from Step 1.
- If many commands have been programmed to the MODE button, then the SEND/LEARN indicator may remain lit for some time during Step 2. This is not a malfunction.

Using a Macro function

What is a Macro function?

A Macro function enables you to program a series of button operations (up to 16) on the remote controller into a single button. For example, to play a compact disc player connected to the DTR-9.1 normally, you must perform the following steps:

1. Press the **AUDIO/TAPE MODE** button.
2. Press the **POWER ON** button.
3. Press the **CD (INPUT SELECTOR)** button.
4. Press the **CD MODE** button.
5. Press the **playback** button.

By using the macro function, you can perform the above five operations by **only pressing two buttons**.

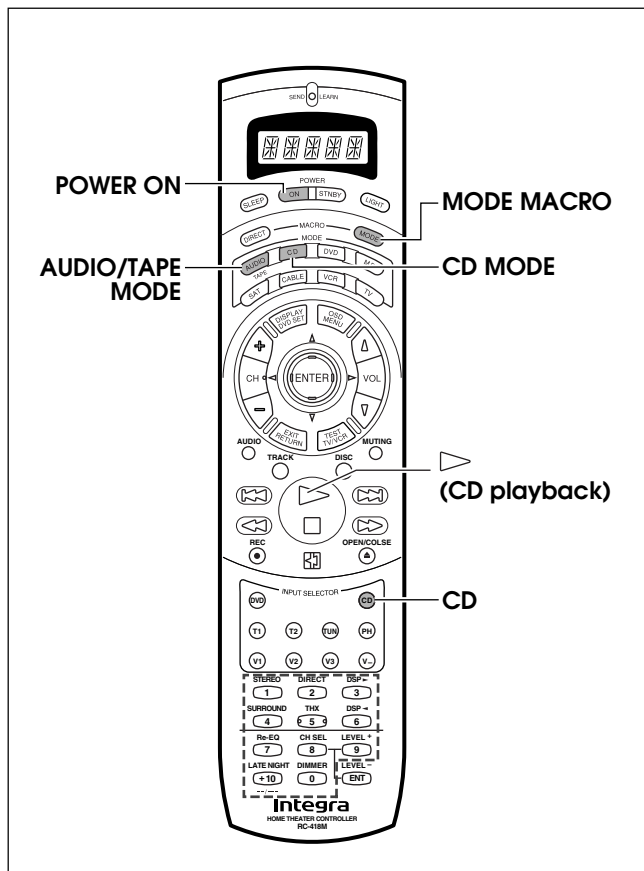

Tips:

- If you erase or change the command of a button programmed in a macro, that operation of that button will no longer work in the macro. In this case, it will be necessary for you to reprogram the macro in order to avoid incorrect operation.
- The codes programmed into a macro will be transmitted at an interval of 0.5 seconds. However, some devices may not be able to complete one operation in 0.5 seconds and may miss the next code. In this case, after pressing one operation button, you can press the same MODE button again before pressing the next operation button to add another 0.5 seconds between the two operations.

Programming a Macro function

You can program a different macro into the MODE MACRO button for each of the eight MODE buttons. The macro is then executed by pressing the appropriate MODE button and then pressing the MODE MACRO button. For example, to program the macro described above into the CD MODE button, perform the steps given below.

1. Press and hold down the desired **MODE button (in this case, the CD MODE button)**, press the **MODE MACRO** button, and then release both buttons.

When you press the MODE CD button, the SEND/LEARN indicator lights and "CD" appears in the display. When you press the MODE MACRO button, the indicator turns off. When you release the buttons, the indicator flashes and lights again and "M 01" appears in the display.

2. Press the operation buttons you wish to program in order (in this case, press **AUDIO/TAPE MODE** → **POWER ON** → **CD (INPUT SELECTOR)** → **CD MODE** → **playback button**).

When you press each button, the SEND/LEARN indicator turns off and the display changes from "M 01" → "M 02" → "M 03" → etc. When you release the button, the indicator lights.

3. Press the **MODE MACRO** button to complete the programming.

The SEND/LEARN indicator flashes twice slowly and "SAVED" appears in the display.

4. Run the macro to check to see if the macro has been properly programmed.

Notes:

- You may program up to 16 button operations into each macro function. If you try to program a 17th operation, it will be ignored, "SAVED" appears in the display, and programming is stopped.
- If no button is pressed for more than 30 seconds during the programming, the SEND/LEARN indicator flashes three times quickly, "ERROR" appears in the display, and the remote controller exits the programming mode. Resume from Step 1.
- If you perform an invalid operation during programming, the SEND/LEARN indicator flashes three times quickly, "ERROR" appears in the display, and the remote controller exits the programming mode. Resume from Step 1.

Running a Macro function

Perform the procedure below to run a macro function that you have programmed into the remote controller. After programming a macro, you should always run it at least once to make sure that it has been programmed properly.

1. Point the remote controller at the DTR-9.1 and press the **CD MODE** button.
2. Press the **MODE MACRO**, and verify that the devices operate properly.

It may take a while for the macro to finish transmitting, so be sure to continue pointing the remote controller at the device until the SEND/LEARN indicator turns off.

Using a Macro function

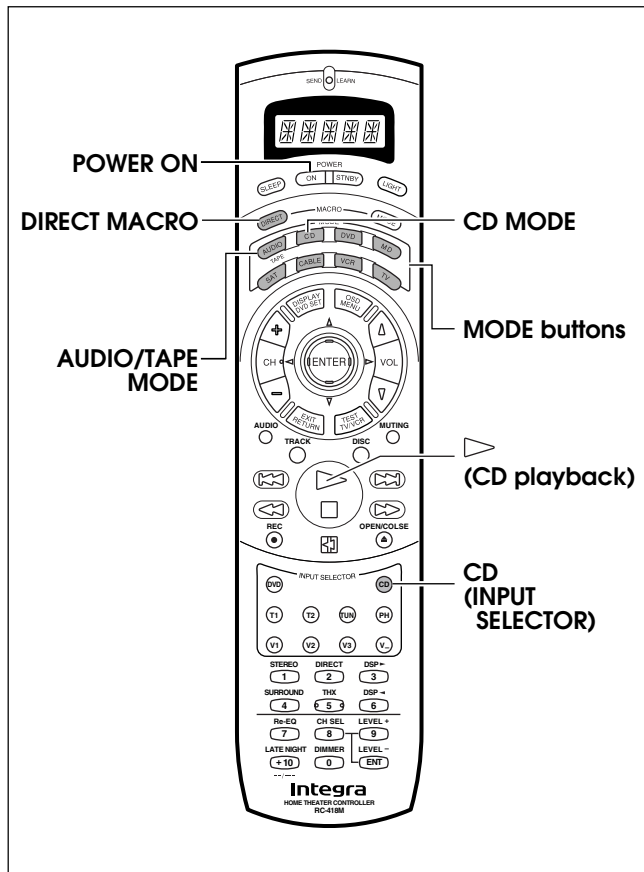

Tips:

- If you erase or change the command of a button programmed in the direct macro, that operation of that button will no longer work in the macro. In this case, it will be necessary for you to reprogram the direct macro in order to avoid incorrect operation.
- The codes programmed into a direct macro will be transmitted at an interval of 0.5 seconds. However, some devices may not be able to complete one operation in 0.5 seconds and may miss the next code. In this case, after pressing one operation button, you can press the same MODE button again before pressing the next operation button to add another 0.5 seconds between the two operations.

Programming the Direct Macro function

With the direct macro function, you can program a series of button operations as a macro into the DIRECT MACRO button so the macro can be executed with just one touch. Note that for the direct macro function, only one macro can be programmed. For example, to program the macro described on the previous page for the DIRECT MACRO button, perform the steps given below.

1. Press and hold down any one of the eight MODE buttons, press the DIRECT MACRO button, and then release both buttons.

When you press the MODE button, the SEND/LEARN indicator lights and that mode appears in the display. When you press the DIRECT MACRO button, the indicator turns off. When you release the buttons, the indicator flashes briefly and then lights again and "M 01" appears in the display.

2. Press the operation buttons you wish to program in order (in this case, press AUDIO/TAPE MODE → POWER ON → CD (INPUT SELECTOR) → CD MODE → playback button).

When you press each button, the SEND/LEARN indicator turns off and the display changes from "M 01" → "M 02" → "M 03" → etc. When you release the button, the indicator lights.

3. Press the DIRECT MACRO button to complete the procedure.

The SEND/LEARN indicator flashes twice slowly and "SAVED" appears in the display.

4. Check to see if the macro has been properly programmed.

Notes:

- You may program up to 16 button operations into each macro function. If you try to program a 17th operation, it will be ignored, "SAVED" appears in the display, and programming is stopped.
- If no button is pressed for more than 30 seconds during the programming, the SEND/LEARN indicator flashes three times quickly, "ERROR" appears in the display, and the remote controller exits the programming mode. Resume from Step 1.
- If you perform an invalid operation during programming, the SEND/LEARN indicator flashes three times quickly, "ERROR" appears in the display, and the remote controller exits the programming mode. Resume from Step 1.

Running a Direct Macro function

Perform the procedure below to run a direct macro function that you have programmed into the remote controller. After programming a direct macro, you should always run it at least once to make sure that it has been programmed properly.

1. Point the remote controller at the DTR-9.1 and press the DIRECT MACRO button.

It may take a while for the macro to finish transmitting, so be sure to continue pointing the remote controller at the device until the SEND/LEARN indicator turns off.

Using a Macro function

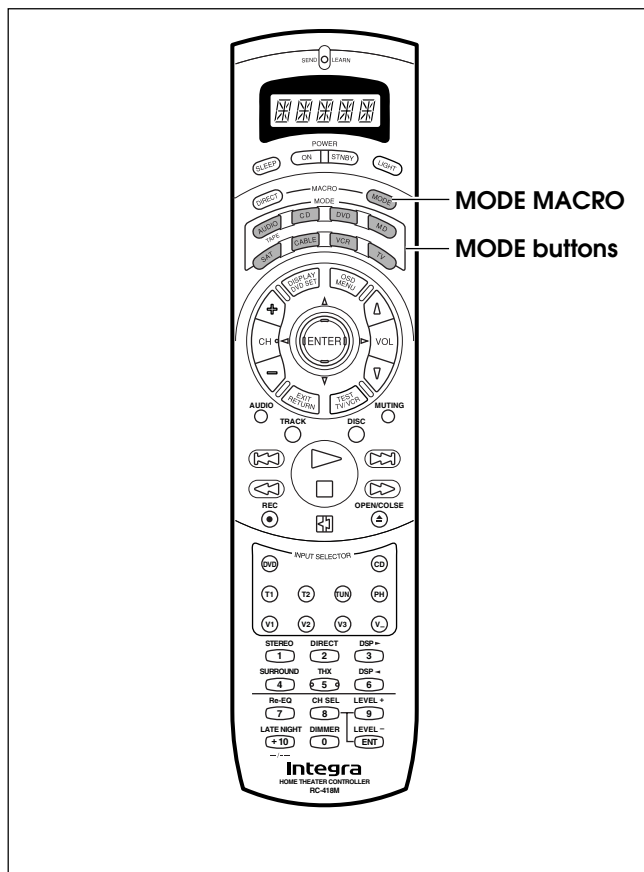

Erasing a macro from the MODE MACRO button

1. Press and hold down the desired **MODE** button, press the **MODE MACRO** button, and then release both buttons.

When you press the MODE button, the SEND/LEARN indicator lights and that mode appears in the display. When you press the MODE MACRO button, the indicator turns off. When you release the buttons, the indicator flashes once and "M 01" appears in the display.

2. Press the **MODE MACRO** button again.

The SEND/LEARN indicator flashes twice slowly and "CLEAR" appears in the display. The macro programmed to the MODE button pressed in Step 1 above is erased.

Notes:

- If no button is pressed for more than 30 seconds during the programming, the SEND/LEARN indicator flashes three times quickly, "ERROR" appears in the display, and the remote controller exits the programming mode. Resume from Step 1.
- Be aware that if you press a button other than MODE MACRO button in Step 2, then you will in effect be overwriting the previous macro with a new macro.

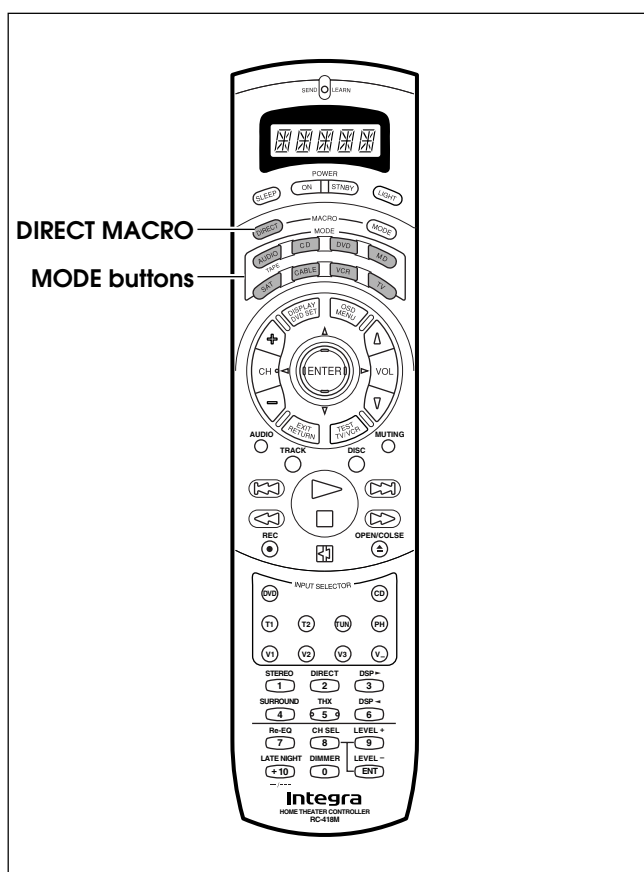

Erasing a direct macro from the DIRECT MACRO button

1. Press and hold down any one of the eight **MODE** buttons, press the **DIRECT MACRO** button, and then release both buttons.

When you press the MODE button, the SEND/LEARN indicator lights and that mode appears in the display. When you press the DIRECT MACRO button, the indicator turns off. When you release the buttons, the indicator flashes once and "M 01" appears in the display.

2. Press the **DIRECT MACRO** button again.

The SEND/LEARN indicator flashes twice slowly and "CLEAR" appears in the display. The macro programmed to the DIRECT MACRO button is erased.

Notes:

- If no button is pressed for more than 30 seconds during the programming, the SEND/LEARN indicator flashes three times quickly, "ERROR" appears in the display, and the remote controller exits the programming mode. Resume from Step 1.
- Be aware that if you press a button other than DIRECT MACRO button in Step 2, then you will in effect be overwriting the previous direct macro with a new direct macro.

Using a Macro function

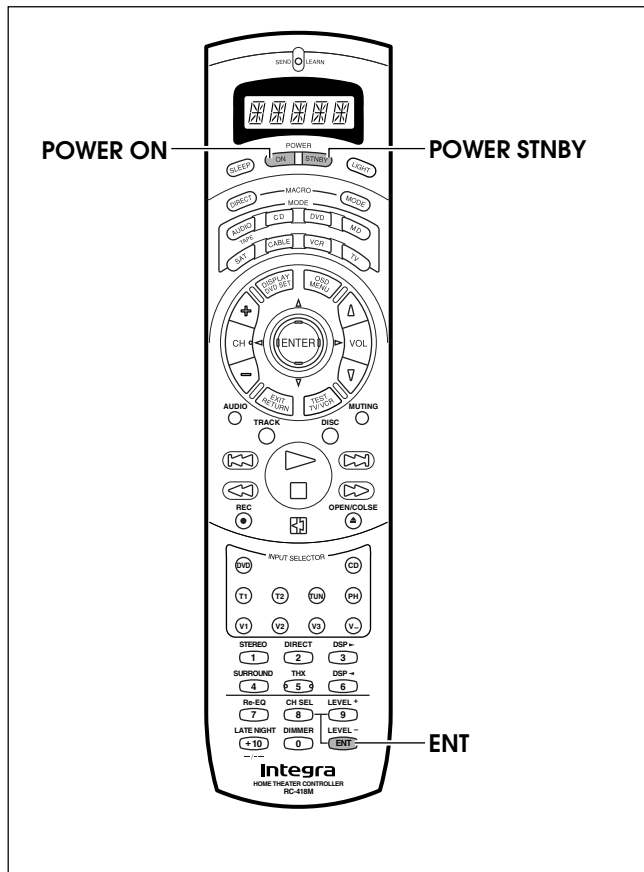

Erasing all commands and macros that have been programmed

This procedure will erase all the commands and macros that you have programmed into the remote controller and return it to its default settings. This operation will not affect the preset settings of the remote controller.

1. **Open the battery cover and remove the batteries from the remote controller.**
2. **While pressing and holding down the POWER ON and POWER STNBY buttons, re-insert the batteries in their correct orientation, and then release both buttons.**

The SEND/LEARN indicator flashes slowly and "CLEAR" appears in the display.

3. **Press the ENT button.**

The SEND/LEARN indicator lights up for about ten seconds and then turns off and "AUDIO" appears in the display.

All programmed commands and macros are erased and the remote controller returns to its factory presets.

Notes:

- Proceed to Step 3 immediately after Step 2; otherwise, the batteries will be consumed quickly.
- If you press any button other than the ENT button in Step 3, nothing will be erased. In this case, resume from Step 1.

Macro mode programming memo:

MACRO	MODE MACRO ↓ AUDIO	MODE MACRO ↓ CD	MODE MACRO ↓ DVD	MODE MACRO ↓ MD	MODE MACRO ↓ SAT	MODE MACRO ↓ CABLE	MODE MACRO ↓ VCR	MODE MACRO ↓ TV	DIRECT MACRO
Operation 1									
Operation 2									
Operation 3									
Operation 4									
Operation 5									
Operation 6									
Operation 7									
Operation 8									
Operation 9									
Operation 10									
Operation 11									
Operation 12									
Operation 13									
Operation 14									
Operation 15									
Operation 16									

Troubleshooting guide

If a problem occurs while you are using the remote controller, first try to operate the controls on the front panel of the DTR-9.1 to make sure that it is not due to a malfunction (or worn out batteries) in the remote controller.

POWER

Power shuts off immediately after power on.

- Amplifier protection circuitry has been activated.
→ Remove the power cord from outlet immediately. Contact your Integra/Onkyo service center.

No power.

- Power cord is disconnected.
→ Connect power cord.
- External noise is affecting the internal micro-computer.
→ Turn the power button off and then on again or remove the power cord from the outlet and then plug it in again.
- Internal fuse is blown.
→ Contact your Integra/Onkyo Service Center.

Power turns on but no sound.

- "Muting" is displayed.
→ Press the MUTING button on the remote controller to turn it off.
- Bad connections or wiring.
→ Check connections, speaker cables, etc.
- Amplifier protection circuitry has been activated.
→ Contact your Integra/Onkyo Service Center.

The sound of the playback source is not heard.

- Input selector is not set properly.
→ Set to correct input source.
- Headphones are connected.
→ Lower volume and then disconnect headphones.

SPEAKERS

No sound from the center speaker, or at very low volume.

- Speaker cable is not connected.
→ Check the connection between the amplifier and the speaker.
- Listening mode is set to Stereo or Direct.
→ Set the Listening mode to any mode other than Stereo or Direct. The output to the center speaker may differ depending on the listening mode.
- CENTER level is set to minimum.
→ Set the CENTER level to the appropriate volume.
- CENTER SPEAKER is set to "None."
→ Set CENTER SPEAKER to "Large" or "Small."

No sound or very low volume from subwoofer

- Subwoofer is set to "No."
→ Check the speaker setting.
- Subwoofer speakers output level setting is improper.
→ Check the output level of the Subwoofer using the test tone.

Low frequency humming is heard

- Not properly grounded.
→ Check outer conductor of input plugs.
- Turntable motor is not properly grounded.
→ Check for proper ground connection.
- Audio connection cables on the rear panel are connected incorrectly.
→ Adjust the placement of the cable to reduce hum.

Howling is heard when the volume is turned up.

- Turntable and speakers are located too close together.
→ Move them farther apart.

Rough or scratchy sound is heard. High range is not clear.

- The needles of turntable is dirty or worn, or a problem exists with a connected component.
→ Refer to the instruction of the connected components and check for problem.
- Treble control too high.
→ Turn treble down.

Troubleshooting guide

FM/AM TUNER

AM stations cannot be received.

- AM loop antenna is not connected.
→ Connect the included AM loop antenna to the AM antenna terminals.

Buzzing noise on AM stations (particularly noticeable at night or with weak stations).

- Noise from electrical apparatus such as fluorescent lamp.
→ Move the AM loop antenna to different position.
→ Set up an outdoor AM antenna.

Noise is heard at high-pitched sounds on AM stations.

- Noise from TV set.
→ Place the AM loop antenna as far as possible from the TV.
→ Move unit away from TV set.

Crackling noise on both AM and FM stations

- Noise caused by fluorescent lamp being turned on and off.
→ Move antenna as far as possible from the fluorescent lamp.
- Noise from automobile ignition.
→ Install an FM outdoor antenna as far as possible from the road.
→ Change the position or direction of the outdoor antenna.

The indicators light for stereo reception, but sound is distorted and stereo separation is bad.

- Station is too strong.
→ Change to FM indoor antenna.
- Multiple reflection of the radio waves because of tall buildings or mountains.
→ Use antenna that has better directivity and select a point where distortion is least.

Indicators for stereo reception flicker and hiss is heard on FM stations.

- Station is too weak.
→ Install an outdoor FM antenna.
- Stereo FM broadcasts cover only about half the distance of an ordinary broadcast.
→ Change the position or direction of the outdoor antenna.

No preset station is recalled.

- Power cord has been unplugged or the POWER switch has been turned off for a long time.
→ The memory contents are lost. Store all stations again.

VIDEO and AUDIO

Desired picture does not appear.

- Improper connection.
→ Check the connection again. Insert the plugs and connectors completely.
- Video Setup sub-menu of Input Setup menu settings are incorrect.
→ Check Settings.

No on-screen display.

- Improper connection.
→ Check connections.
- OSD Menu is only display to monitor connected to MONITOR 1.
→ If connected to MONITOR 2, reconnect to MONITOR 1.

Picture and sound do not match.

- Improper connection.
→ Check connections.
- Video Setup sub-menu of Input Setup menu settings are incorrect.
→ Check settings.

No sound, or sound of the selected source is not heard.

- Digital Setup sub-menu of Input Setup menu settings are incorrect.
→ Check settings.

No picture appears on the TV screen (or monitor).

- TV (or monitor) is not set to receive the output signals from the receiver.
→ Set the TV (or monitor) to the receiver input.
- Video cable is not connected securely.
→ Check connections.
- S VIDEO IN signal is output at VIDEO OUT and S-VIDEO OUT, but VIDEO IN signal is only output at VIDEO OUT. Also, COMPONENT VIDEO IN signal is only output at COMPONENT VIDEO OUT.
→ Check the input and output signals.

REMOTE CONTROLLER

Front panel controls function but remote controller controls do not.

- No batteries in remote controller.
→ Insert batteries.
- Batteries have worn out.
→ Replace batteries.

Troubleshooting guide

- Remote controller is not pointed at the remote sensor of the DTR-9.1.
→ Point the remote controller at the remote sensor of the DTR-9.1.
- Remote controller is too far from the DTR-9.1.
→ Operate the remote controller within 16 feet (5 meters).
- Remote controller is functioning in a different mode
→ Press the AUDIO MODE button.

OTHER

LATE NIGHT function cannot be used.

- Playback source is not Dolby Digital encoded.
→ Check that the DOLBY DIGITAL indicator lights up on the display.

LFE LEVEL function cannot be used.

- Playback source is not Dolby Digital, DTS, or MPEG encoded.
→ Check that the DOLBY DIGITAL, DTS, or MPEG indicator lights up on the display.

Cinema Re-EQ function cannot be used.

- Listening mode is set to "Theater-Dimensional" or "Direct."
→ See table on page 45.

Parameter cannot be set for Front Effect, Reflect Level, Reverb Level, Room Size, etc.

- Parameter may not be able to be set depending on the listening mode.
→ See table on page 45.

Multichannel audio is not output.

- To listen to multichannel audio, "Yes" must be selected in the Multichannel sub-menu in the Input Setup menu.
→ Check that the component is connected to the MULTI CHANNEL INPUT port and check the OSD Menu settings.

Cannot change OSD Menu settings.

- OSD Menu is locked so that it cannot be changed.
→ Set "Unlocked" at the Lock Setup sub-menu in the About menu.

Components in remote zone (Zone 2) do not operate properly.

- Components are incorrectly connected.
→ Check connections.
- Objects are interfering with remote controller signals.
→ Move interfering objects away from path of remote controller signals.

For digital sources, sound is sometimes not output depending on media type.

- Format of digital input source is fixed. Other digital formats will not be output.
→ Set Digital Format to "Auto" in the Digital Setup sub-menu of the Input Setup menu.

For DTS and MPEG sources, noises or incorrect starts occur when the digital source is played.

- Digital Format settings is incorrect.
→ Try setting Digital Format to the same as the input source in the Digital Setup sub-menu of the Input Setup menu.

Operation of fan is heard.

- DTR-9.1 is equipped with internal ventilation fan to prevent overheating. This is not a malfunction.

OSD menu settings cannot be changed.

- The settings are locked.
→ Unlock the settings in the OSD menu: About → Lock Setup → Unlocked.

Components do not operate from the remote zone (Zone 2)

- Improper connection.
→ Check connections.
- Something is blocking the remote sensor.
→ Move the obstacle.

Sound for a digital source turns on and off depending on the media being played.

- Digital input format is fixed, so other formats are not played.
→ Set "Auto" in the OSD menu: Input Setup → Digital Setup → Digital Format → Auto.

When playing digital sources such as DTS and MPEG sources, noise is heard or the beginning is cut off.

- Set the format type in the OSD menu: Input Setup → Digital Setup → Digital Format.

Also refer to the respective instruction manuals of the compact disc player, DVD player, video cassette recorder, TV monitor, etc., that compose your entertainment system.

Since the unit contains a microcomputer to provide advanced functions, it may malfunction due to external noise or static electricity. If this happens, press the POWER switch on the unit and then press it in again after about five seconds.

The default settings

The following table shows the factory-set default parameter values. Use it as a reference when you change these parameter values as needed, although they are usable in many cases.

To return to the factory-set default parameters, press and hold down the VIDEO 1 button, and then press the STANDBY/ON button. "Clear" appears in the display and then the DTR-9.1 returns to the standby state.

1. Speaker Setup

1-1. Speaker Config

- a. Subwoofer: Yes
- b. Front: Small
- c. Center: Small
- d. Surround L/R: Small
- e. Surround Back: Small

1-2. Speaker Distance

- a. Unit: feet
- b. Front L/R: 3.6m/12ft
- c. Center: 3.6m/12ft
- d. Surr Right: 2.1m/7ft
- e. Surr Bk R: 2.1m/7ft
- f. Surr Bk L: 2.1m/7ft
- g. Surr Left: 2.1m/7ft
- h. Subwoofer: 3.6m/12ft

1-3. Level Calibration

- a. Left: 0.0dB
- b. Center: 0.0dB
- c. right: 0.0dB
- d. Surr Right: 0.0dB
- e. Surr Bk R: 0.0dB
- f. Surr Bk L: 0.0dB
- g. Surr Left: 0.0dB
- h. Subwoofer: 0.0dB

1-4. Bass Peak Level

- a. Bass Peak Level Limiter: Off
- b. Peak Level: +18dB

1-5. LFE Level Setup

- a. Dolby Digital: 0dB
- b. DTS Cinema: 0dB
- c. DTS Music: 0dB
- d. MPEG Cinema: 0dB
- e. MPEG Music: 0dB

2. Input Setup

2-1. Digital Setup

- a. Digital Input: CD: COAX1
TAPE1: OPT1
TAPE2: OPT2
DVD: OPT3
VIDEO1: ----
VIDEO2: COAX2
VIDEO3: COAX3
VIDEO4: COAX4
VIDEO5: COAX5
- b. Digital Format: Auto

2-2. Multichannel Setup

- a. Multichannel: CD: No
TAPE1: No
TAPE2: No
DVD: No
VIDEO1: No
VIDEO2: No
VIDEO3: No
VIDEO4: No
VIDEO5: No

2-3. Video Setup

- a. Video: CD: Last valid
PHONO: Last valid
FM: Last valid
AM: Last valid
TAPE1: Last valid
TAPE2: Last valid
DVD: DVD

- VIDEO1: VIDEO1
VIDEO2: VIDEO2
VIDEO3: VIDEO3
VIDEO4: VIDEO4
VIDEO5: VIDEO5
- b. Component Video: DVD: Component Video1
VIDEO1: ----
VIDEO2: Component Video2
VIDEO3: Component Video3
VIDEO4: ----
VIDEO5: ----

2-4. Listening Mode Setup

- a. Analog/PCM: Stereo
- b. PCM fs>48k: Stereo
- c. PCM fs=192k: Stereo
- d. Dolby D: Dolby D
- e. DTS: DTS
- f. MPEG: MPEG Multi
- g. D.F.2ch: Pro Logic
- h. D.F.Mono: Mono

2-5. Delay

- a. A/V Sync: 0.0ms
- b. Relative Delay Center: 0.0ms
- c. Relative Delay Surr L/R: 0.0ms
- d. Relative Delay Surr Back: 0.0ms

2-6. Sound Effect

- a. Bass: 0
- b. Treble: 0

2-7. Character Input

- a. Character Display: No
- b. Character: None

2-8. Miscellaneous Setup

- a. IntelliVolume: 0dB
- b. 12V Trigger: Off

4. Preference

4-1. Volume Setup

- a. Volume Display: Absolute
- b. Muting Level: - dB
- c. Maximum Volume: Off
- d. Power On Volume: Last valid

4-2. OSD Setup

- a. Background Color: Blue1
- b. Superimpose Mode: Normal
- c. Immediate Display: On
- d. Display Position: Bottom
- e. Timeout: 3sec
- f. TV Format: Auto

4-3. OSD Tweak

- a. ← / → / ↑ / ↓: 0.0

5. Zone2 OSD Setup

5-1. OSD Setup

- a. Background Color: Blue1
- b. Superimpose Mode: Normal
- c. Immediate Display: Off
- d. Display Position: Bottom
- e. Timeout: 3sec
- f. TV Format: Auto

6. About

6-1. Lock Setup

- a. Lock: Unlocked

6-2. Version

- b. Master ID: _____

Your system setting

This page is for you to record the settings you have made for the components connected to the DTR-9.1. If a system installer will install your system for you, then ask him to fill in this page for you.

Example: If you connected a **Integra** DPS-5 to the DVD input, then enter "INTEGRA DPS-5" for the name, circle items corresponding to the connections and settings that you have made, and fill in the items where blanks are given.

Inputs

DVD

Name: _____

Digital Input connection: OPT1, OPT2, OPT3, COAX1, COAX2, COAX3, COAX4, COAX5, not connected

Multichannel Setup: Yes, No

Video Input

Video: DVD, VIDEO1, VIDEO2, VIDEO3, VIDEO4, VIDEO5, not connected

Component Video: INPUT1, INPUT2, INPUT3, not connected

Video Output: VIDEO1, VIDEO2, COMPONENT, not connected

Video Setup: DVD, VIDEO1, VIDEO2, VIDEO3, VIDEO4, VIDEO5, ----

Intelli Volume: _____ dB

Character Input: Yes (name: _____) , No

Listening Mode Preset

1. Input source signal: _____

Listening Mode: _____

2. Input source signal: _____

Listening Mode: _____

3. Input source signal: _____

Listening Mode: _____

VIDEO 1

Name: _____

Digital Input: OPT1, OPT2, OPT3, COAX1, COAX2, COAX3, COAX4, COAX5, not connected

Multichannel Setup: Yes, No

Video Input

Video: DVD, VIDEO1, VIDEO2, VIDEO3, VIDEO4, VIDEO5, not connected

Component Video: INPUT1, INPUT2, INPUT3, not connected

Video Output: VIDEO1, VIDEO2, COMPONENT, not connected

Video Setup: DVD, VIDEO1, VIDEO2, VIDEO3, VIDEO4, VIDEO5, ----

Intelli Volume: _____ dB

Character Input: Yes (name: _____) , No

Listening Mode Preset

1. Input source signal: _____

Listening Mode: _____

2. Input source signal: _____

Listening Mode: _____

3. Input source signal: _____

Listening Mode: _____

VIDEO 2

Name: _____

Digital Input: OPT1, OPT2, OPT3, COAX1, COAX2, COAX3, COAX4, COAX5, not connected

Multichannel Setup: Yes, No

Video Input

Video: DVD, VIDEO1, VIDEO2, VIDEO3, VIDEO4, VIDEO5, not connected

Component Video: INPUT1, INPUT2, INPUT3, not connected

Video Output: VIDEO1, VIDEO2, COMPONENT, not connected

Video Setup: DVD, VIDEO1, VIDEO2, VIDEO3, VIDEO4, VIDEO5, ----

Intelli Volume: _____ dB

Character Input: Yes (name: _____) , No

Listening Mode Preset

1. Input source signal: _____

Listening Mode: _____

2. Input source signal: _____

Listening Mode: _____

3. Input source signal: _____

Listening Mode: _____

VIDEO 3

Name: _____

Digital Input: OPT1, OPT2, OPT3, COAX1, COAX2, COAX3, COAX4, COAX5, not connected

Multichannel Setup: Yes, No

Video Input

Video: DVD, VIDEO1, VIDEO2, VIDEO3, VIDEO4, VIDEO5, not connected

Component Video: INPUT1, INPUT2, INPUT3, not connected

Video Output: VIDEO1, VIDEO2, COMPONENT, not connected

Video Setup: DVD, VIDEO1, VIDEO2, VIDEO3, VIDEO4, VIDEO5, ----

Intelli Volume: _____ dB

Character Input: Yes (name: _____) , No

Listening Mode Preset

1. Input source signal: _____

Listening Mode: _____

2. Input source signal: _____

Listening Mode: _____

3. Input source signal: _____

Listening Mode: _____

Your system setting

VIDEO 4

Name: _____

Digital Input: OPT1, OPT2, OPT3, COAX1, COAX2, COAX3, COAX4, COAX5, not connected

Multichannel Setup: Yes, No

Video Input

Video: DVD, VIDEO1, VIDEO2, VIDEO3, VIDEO4, VIDEO5, not connected

Component Video: INPUT1, INPUT2, INPUT3, not connected

Video Output: VIDEO1, VIDEO2, COMPONENT, not connected

Video Setup: DVD, VIDEO1, VIDEO2, VIDEO3, VIDEO4, VIDEO5, ----

Intelli Volume: _____ dB

Character Input: Yes (name: _____) , No

Listening Mode Preset

1. Input source signal: _____

Listening Mode: _____

2. Input source signal: _____

Listening Mode: _____

3. Input source signal: _____

Listening Mode: _____

VIDEO 5

Name: _____

Digital Input: OPT1, OPT2, OPT3, COAX1, COAX2, COAX3, COAX4, COAX5, not connected

Multichannel Setup: Yes, No

Video Input

Video: DVD, VIDEO1, VIDEO2, VIDEO3, VIDEO4, VIDEO5, not connected

Component Video: INPUT1, INPUT2, INPUT3, not connected

Video Output: VIDEO1, VIDEO2, COMPONENT, not connected

Video Setup: DVD, VIDEO1, VIDEO2, VIDEO3, VIDEO4, VIDEO5, ----

Intelli Volume: _____ dB

Character Input: Yes (name: _____) , No

Listening Mode Preset

1. Input source signal: _____

Listening Mode: _____

2. Input source signal: _____

Listening Mode: _____

3. Input source signal: _____

Listening Mode: _____

TAPE 1

Name: _____

Digital Input: OPT1, OPT2, OPT3, COAX1, COAX2, COAX3, COAX4, COAX5, not connected

Multichannel Setup: Yes, No

Video Setup: DVD, VIDEO1, VIDEO2, VIDEO3, VIDEO4, VIDEO5, ----

Intelli Volume: _____ dB

Character Input: Yes (name: _____) , No

Listening Mode Preset

1. Input source signal: _____

Listening Mode: _____

2. Input source signal: _____

Listening Mode: _____

TAPE 2

Name: _____

Digital Input: OPT1, OPT2, OPT3, COAX1, COAX2, COAX3, COAX4, COAX5, not connected

Multichannel Setup: Yes, No

Video Setup: DVD, VIDEO1, VIDEO2, VIDEO3, VIDEO4, VIDEO5, ----

Intelli Volume: _____ dB

Character Input: Yes (name: _____) , No

Listening Mode Preset

1. Input source signal: _____

Listening Mode: _____

2. Input source signal: _____

Listening Mode: _____

AM

Video Setup: DVD, VIDEO1, VIDEO2, VIDEO3, VIDEO4, VIDEO5, ----

Intelli Volume: _____ dB

Character Input: Yes (name: _____) , No

Listening Mode Preset

a. Analog/PCM: _____

FM

Video Setup: DVD, VIDEO1, VIDEO2, VIDEO3, VIDEO4, VIDEO5, ----

Intelli Volume: _____ dB

Character Input: Yes (name: _____) , No

Listening Mode Preset

a. Analog/PCM: _____

PHONO

Video Setup: DVD, VIDEO1, VIDEO2, VIDEO3, VIDEO4, VIDEO5, ----

Intelli Volume: _____ dB

Character Input: Yes (name: _____) , No

Listening Mode Preset

a. Analog/PCM: _____

Your system setting

CD

Name: _____

Digital Input: OPT1, OPT2, OPT3, COAX1, COAX2, COAX3, COAX4, COAX5, not connected

Multichannel Setup: Yes, No

Video Setup: DVD, VIDEO1, VIDEO2, VIDEO3, VIDEO4, VIDEO5, ----

Intelli Volume: _____ dB

Character Input: Yes (name: _____) , No

Listening Mode Preset

1. Input source signal: _____

Listening Mode: _____

2. Input source signal: _____

Listening Mode: _____

Speakers

Speaker configuration

Subwoofer **Yes, No**

Name: _____

Distance: _____ m/ft

Level: _____ dB

Front **Yes, No**

Name: _____

Distance: L: _____ m/ft R: _____ m/ft

Level: L: _____ dB R: _____ dB

Center **None, Large, Small**

Name: _____

Distance : _____ m/ft

Level: _____ dB

Surround **None, Large, Small**

Name: _____

Distance : _____ m/ft

Level: L: _____ dB R: _____ dB

Surround Back **None, Large, Small**

Name: _____

Distance : L: _____ m/ft R: _____ m/ft

Level: L: _____ dB R: _____ dB

Bass Peak Level

Bass peak level Limiter: On, Off

Peak Level: _____ dB

LFE Level Setup

Dolby Digital: _____ dB

DTS Cinema: _____ dB

DTS Music: _____ dB

MPEG Cinema: _____ dB

MPEG Music: _____ dB

Volume Setup

Volume Display: Absolute, Relative

Muting Level: Absolute _____ dB, Relative _____

Maximum Volume: Absolute _____ dB, Relative _____

Power On Volume: Absolute _____ dB, Relative _____

OSD Setup

Background Color: Blue1, Blue2, Green1, Green2, Magenta, Red1, Red2

Superimpose: Off, Normal, Black

Immediate Display: On, Off

Display Position: Bottom, _____, Top

Timeout: _____ sec

TV Format: Auto, NTSC, PAL

ZONE2

Speaker: _____

Monitor: _____

Power Amplifier: _____

Zone2 OSD Setup

Background Color: Blue1, Blue2, Green1, Green2, Magenta, Red1, Red2

Superimpose: Off, Normal, Black

Immediate Display: On, Off

Display Position: Bottom, _____, Top

Timeout: _____ sec

TV Format: Auto, NTSC, PAL

About

Lock Setup

Parameter Lock: Unlocked, Locked

Version

Master ID: _____

Specifications

AMPLIFIER SECTION

Continuous Average Power output (FTC)

All channels: 130 watts per channel min. RMS at 8 ohms, 2 channels driven from 20 Hz to 20 kHz with no more than 0.05% total harmonic distortion.
170 watts min. RMS at 6 ohms, 2 channels driven from 1 kHz with no more than 0.1% total harmonic distortion.

Continuous Power output (DIN)

160 watts at 6 ohms

Maximum Power output (EIAJ)

200 watts at 6 ohms

Dynamic Power Output (Stereo)

2 × 300 watts at 3 ohms
2 × 230 watts at 4 ohms
2 × 150 watts at 8 ohms

Total Harmonic Distortion:

0.05% at rated power

IM Distortion:

0.05% at rated power

0.05% at 1 Watt output

Damping Factor:

60 at 8 ohms

Input Sensitivity and Impedance

PHONO: 2.5 mV, 50 kohms

LINE (CD, TAPE 1-2, DVD,

VIDEO 1-5): 200 mV, 50 kohms

MULTICHANNEL INPUT

(FRONT L/C/R, SURROUND

L/R, SURROUND BACK L/R): 200 mV, 50 kohms

(SUBWOOFER): 36 mV, 50 kohms

AMP IN (FRONT L/C/R) : 1 V, 50 kohms

COAXIAL 1-5 (DIGITAL): 0.5 Vp-p, 75 ohms

DVD, VIDEO1-5: 1 Vp-p, 75 ohms

1 Vp-p, 75 ohms (Y)

0.28 Vp-p, 75 ohms (C)

COMPONENT VIDEO 1-3: 1 Vp-p, 75 ohms (Y)

0.5 Vp-p, 75 ohms (Pb, Pr)

Output Level and Impedance

Rec out (TAPE 1-2, VIDEO 1-2):

200 mV, 2.2 kohms

Pre out: 1 V, 470 ohms

ZONE 2 OUT: 100mV, 470 ohms

VIDEO (VIDEO 1-2, MONITOR

OUT, ZONE 2 OUT): 1 Vp-p, 75 ohms

1 Vp-p, 75 ohms (Y)

0.28 p-p, 75 ohms (C)

COMPONENT VIDEO OUT: 1 Vp-p, 75 ohms (Y)

0.5 Vp-p, 75 ohms (Pb, Pr)

Phono Overload:

110 mV RMS at 1 kHz, 0.5% T.H.D.

Frequency Response:

20 Hz to 30 kHz : ±1dB

(CD in Direct mode)

5 Hz to 100 kHz : +1dB,-3dB

(CD in Direct mode)

20 to 20 kHz : ±0.8 dB

RIAA Deviation:

Tone Control

Bass: ±10 dB at 100 Hz

Treble: ±10 dB at 10 kHz

Signal-to-Noise Ratio (Stereo)

Phono: 80 dB (IHF A, 5 mV input)

CD/Tape: 100 dB (IHF A, 0.5 V input)

TUNER SECTION

FM

Tuning Range: 87.5 — 108.0 MHz (50 kHz steps)

Usable Sensitivity

Mono: 11.2 dBf, 1.0 μV (75 ohms IHF)

0.9 μV (75 ohms DIN)

Stereo: 17.2 dBf, 2.0 μV (75 ohms IHF)

23 μV (75 ohms DIN)

50 dB Quieting Sensitivity

Mono: 17.2 dBf, 2.0 μV (75 ohms)

Stereo: 37.2 dBf, 20 μV (75 ohms)

Capture Ratio:

2.0 dB

Image Rejection Ratio

40 dB

IF Rejection Ratio:

90 dB

Signal-to-Noise Ratio

Mono: 76 dB

Stereo: 70 dB

Alternate Channel Attenuation: 55 dB

Selectivity: 50 dB (DIN)

AM Suppression Ratio: 50 dB

Total Harmonic Distortion

Mono: 0.2%

Stereo: 0.3%

Frequency Response:

30 Hz — 15 kHz, ±1.0 dB

Stereo Separation:

45 dB at 1 kHz

30 dB at 100 Hz — 10 kHz

AM

Tuning Range: 530—1,710 kHz (10 kHz steps)

Usable Sensitivity: 30 μV

Image Rejection Ratio: 40 dB

IF Rejection Ratio: 40 dB

Signal-to-Noise Ratio: 40 dB

Total Harmonic Distortion: 0.7%

GENERAL

Power Supply: AC 120 V, 60 Hz

Power Consumption: 11 A

Dimensions (W × H × D): 17-1/8" × 7-11/16" × 18"

Weight: 49.4 lbs.

REMOTE CONTROLLER

Transmitter: Infrared

Signal range: Approx. 5 meters, 16 ft.

Power supply: Two "AA" batteries (1.5 V × 2)

Specifications and features are subject to change without notice.

Integra Division of

ONKYO U.S.A. CORPORATION

200 Williams Drive, Ramesy, N.J. 07446, U.S.A.

Tel: 201-825-7950 Fax: 201-825-8150 E-mail: integra@onkyousa.com

Integra Division of

ONKYO CORPORATION

Sales & Product Planning Div. : 2-1, Nisshin-cho, Neyagawa-shi, OSAKA 572-8540, JAPAN

Tel: 072-831-8111 Fax: 072-833-5222

SN 29342900

Download from www.Somanuals.com. All Manuals Search And Download.

Printed in Japan
D0004-1



Instruction Manual for upgraded unit

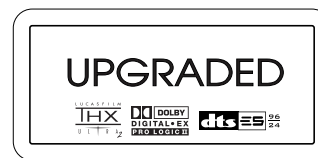

Thank you for using our products.

The upgraded unit now supports the newest decoders and sound formats below as well as conventional sound formats including Dolby Digital, DTS, and THX Surround EX.

With your new AV amplifier, you can enjoy movies and music to their absolute fullest.

Contents

Features	2
Speaker configuration and placement/Connecting speakers	
Speaker placement	3
Speaker Setup	
1-1. Speaker Config sub-menu	4
1-4. THX Audio Setup sub-menu (<i>new function</i>)	5
1-5. LFE Level Setup sub-menu	5
Input Setup	
2-1. Digital Setup sub-menu	6
2-4. Listening Mode Preset sub-menu	6
2-5. Delay sub-menu	16
Listening Mode Setup	
3. Listening Mode Setup menu	10
Other upgraded function	
Selecting audio input signal using the AUDIO button on the remote controller (<i>new function</i>)	16

< How to Use the Instruction Manual for upgraded unit >

The section headings given in this manual correspond to those given in the original instruction manual. Substitute the information given under a heading in this manual for that given under the same heading in the original instruction manual.

Features

■ THX Ultra2

The new THX Ultra2 standard from Lucasfilm ensures the highest sound and picture quality and the most reliable operation. The THX Ultra2 adds the THX Ultra2 Cinema mode and THX MusicMode to the conventional THX Cinema mode to create the optimum sound space for both music and movies.

THX Ultra2 Cinema: When performing 7.1 ch playback of Dolby Digital, DTS, or other 5.1 ch movie sources, THX Ultra2 Cinema analyzes the surround components to create surround back channels for the optimum ambient and directional surround sound. This new THX Ultra2 mode provides a wider sound space to the sides and rear and a heightened feeling of the sound positioning.

THX MusicMode: This is a new mode provided with THX Ultra2 and meant for the playback of music software sources. THX MusicMode converts 5.1 ch multi-channel music sources to 7.1 ch playback with a virtual rear sound from the surround speakers and surround back speakers. The rear sound space is created with the consistency and spaciousness optimum for music playback.

■ DTS 96/24

The upgraded unit is equipped with the newest audio format DTS 96/24 decoder developed by DTS. It is the world's first 96-kHz/24-bit-compatible compression audio format standard for 96-kHz/24-bit, 5.1 ch, high-quality multi-channel playback.

■ DTS-ES Extended Surround Decoder

• DTS-ES Discrete 6.1

This is a new format that all 6.1 ch including added surround back channels are recorded discretely in digital. Because all channels are recorded separately, you can enjoy surround sound with higher separation.

• DTS-ES Matrix 6.1

In this format, sound for added surround back channels is inserted respectively into left and right surround channels with matrix-encoded, and when playing the high precision matrix decoder decodes the inserted sound for surround back channels.

■ DTS Neo:6

This mode uses a high precision matrix decoder to play 2ch sound as 6.1ch sound. Full-band (frequency response: 20 Hz to 20 kHz) playback is available for all 6 channels and you can feel the channel separation of digital discrete level. In addition, you can choose a playback mode from Cinema (for movies) and Music (for music) depending on the source you want to play.

■ Dolby* Digital EX

Dolby Digital Surround EX takes a Dolby Digital 5.1 ch movie surround track and adds a third surround channel for output through a speaker placed behind the viewers. Even though it is hard to create the sound space behind those sitting at the ends of rows in movie theaters, by creating this independent surround channel behind the viewer and adding it to the existing left and right surround channels, the heightened feeling of presence essentially draws you into the scene. The information for the added rear channel is encoded into the left and right surround channels of normal 5.1 Dolby Digital surround tracks. Movie theaters equipped with the Dolby Digital Surround EX decoder can extract the information for the third surround channel. When movies shown using Dolby Digital Surround EX are released on DVDs or 5.1 ch digital television broadcasts as well, the information for the third surround channel is encoded within. With the Dolby Digital EX decoder in your home theater, you can extract the third surround channel and experience the movie with the surround back channel for the sound space that the producer of the movie desired. Just as it is at movie theaters, there is no loss of audio quality or data with the normal 5.1 ch Dolby Digital playback.

■ Dolby* Pro Logic II decoder

This is a surround decoding method which the Dolby Laboratories Inc. suggests. This method uses feedback logic circuits to restore the signal that is matrix-encoded to 2 channel, enabling 5.1 ch playback with maintaining separation as high as Dolby Digital. In this mode, either analog or digital signal can be decoded. There are two modes for Dolby Pro Logic II : Movie and Music. The Movie mode is optimized for playing movies. You can play the dubbed speech recorded in Dolby surround and enjoy the videos with 2 ch sound like old movies in 5.1 ch playback full of live presence. The Music mode will provide more sound space and clearer 3D sound image localization.

Since the new playback formats above are added, the former listening modes such as DTS Film, MPEG Film, Action and Musical are organized into new listening modes. After this, some setup parameters are also updated.

In addition, the following functions are upgraded.

■ Crossover Adjustment

The crossover adjustment enables you to adjust the bass range for the subwoofer according to the sizes of your other speakers.

■ 96 kHz/24 bit upsampling for analog sound

Analog sound signals from VCRs and other sources can now be treated as digital signals and processed with 96 kHz upsampling and 24 bit quantization. This enables more accurate sound playback.

■ Extension of A/V Sync function

You can set the A/V Sync function parameters in the range of 0 to 120 ms.

* Manufactured under license from Dolby Laboratories.

"Dolby," "Surround EX," "Pro Logic" and the double-D symbol are trademarks of Dolby Laboratories.

• Lucasfilm and THX are trademarks or registered trademarks of Lucasfilm, Ltd. Copyright Lucasfilm Ltd. &TM. Surround EX is a jointly developed technology of THX and Dolby Laboratories, Inc. All rights reserved. Used under authorization.

• Manufactured under license from Digital Theater Systems, Inc. US Pat. No.5,451,942 and other worldwide patents issues and pending. "DTS," "DTS-ES Extended Surround," and "Neo:6" are trademarks of Digital Theater Systems, Inc. © 1996 Digital Theater Systems, Inc. All rights reserved.

• "Theater-Dimensional" is a trademark of Onkyo Corporation.

Speaker configuration and placement/ Connecting speakers

Speaker placement

Ideal speaker placement varies depending on the size of your room and the wall coverings. Here, only typical example of speaker placement and recommendations are shown.

Important points regarding speaker placement

Front left and right speakers and center speaker

- Place these three speakers at the same height from the floor.
- Place each speaker so that sound is aimed at the location of the listener's ears when at the listening position.
- Place the front left and right speakers the same distance from the listening position.

Surround left and right speakers

- Place these speakers so that their height is 1 meter (3 feet) higher than that of the listener's ears.

Surround back left and right speakers

- For maximum effect of the new THX Ultra2 feature, place these two speakers as close together as possible. Dipolar speakers, however, should be placed apart the required amount (below right).
- Place these speakers so that their height is 1 meter (3 feet) higher than that of the listener's ears.

Subwoofer

A subwoofer is recommended for the highest bass effect.

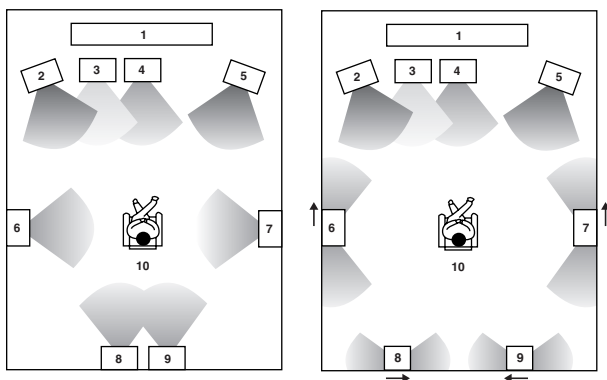

- 1 TV or screen
- 2 Front left speaker
- 3 Subwoofer
- 4 Center speaker
- 5 Front right speaker

- 6 Surround left speaker
- 7 Surround right speaker
- 8 Surround back left speaker
- 9 Surround back right speaker
- 10 Listening position

Most dipoles have an arrow on them to indicate their orientation towards the screen. So for the side dipoles, the arrows point forward. For the back dipoles, the arrows should point towards each other to achieve the correct acoustical phasing in the room.

Speaker Setup

1-1. Speaker Config sub-menu

Here you will enter which speakers are connected and the size of each speaker.

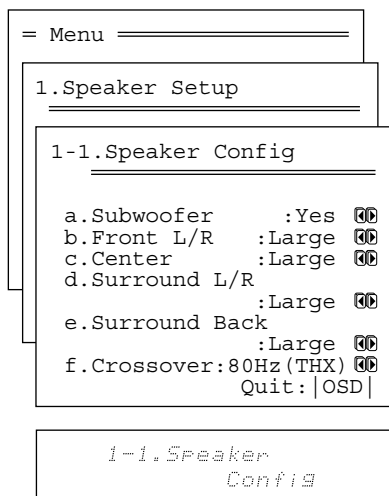

a. Subwoofer

Yes: Select when a subwoofer is connected.

No: Select when a subwoofer is not connected.

b. Front L/R

Large: Select if the front speakers are large sized.

Small: Select if the front speakers are small sized.

- If "No" is selected for the Subwoofer setting, then this setting is fixed to "Large."

c. Center

None: Select if no center speaker is connected.

Large: Select if the center speaker is large sized.

Small: Select if the center speaker is small sized.

- If "Small" is selected for the Front setting, then "Large" cannot be selected for this setting.

d. Surround L/R

None: Select if no surround left and right speakers are connected.

Large: Select if the surround left and right speakers are large sized.

Small: Select if the surround left and right speakers are small sized.

- If "Small" is selected for the Front setting, then "Large" cannot be selected for this setting.

e. Surround Back

None: Select if no surround back left and right speakers are connected.

Large: Select if the surround back left and right speakers are large sized.

Small: Select if the surround back left and right speakers are small sized.

- If "None" is selected for the Surround L/R setting, then this setting is fixed to "None."
- If "Small" is selected for the Surround L/R setting, then "Large" cannot be selected for this setting.

f. Crossover

This setting allows you to set the crossover frequency for your speaker system. The crossover frequency is the minimum frequency delivered to a speaker and can be set to 40 Hz, 60 Hz, 80 Hz (THX), 100 Hz, or 120 Hz. This setting is valid when "Subwoofer" is set to "Yes," or for speakers that are set to "Small," at the "Speaker Config" menu. Frequencies below this are cut from speakers set to "Small" and sent to the subwoofer (or to speakers set to "Large").

Speaker Setup

1-4. THX Audio Setup sub-menu (new function)

The Bass Peak Level sub-menu has been replaced by the THX Audio Setup sub-menu. Use this sub-menu to configure the THX Audio settings such as Boundary Gain Compensation™ and Advanced Speaker Array™.

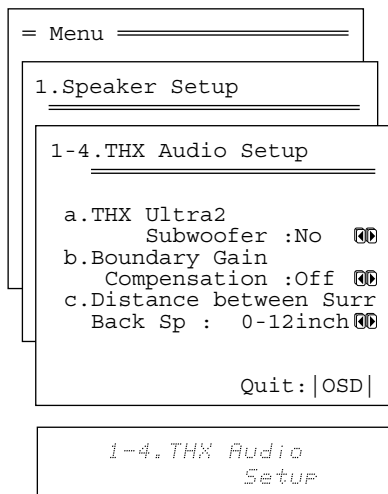

Advanced Speaker Array: When you set up your home theater system using all eight speaker outputs (Left, Center, Right, Surround Right, Surround Back Right, Surround Back Left, Surround Left and Subwoofer) and the two Surround Back speakers are placed close together as shown in the speaker placement diagrams on page 3, you can take advantage of THX's Advanced Speaker Array (ASA) technology. ASA optimizes the surround sound experience using two new modes; THX Ultra2 Cinema and THX MusicMode.

a. THX Ultra2 Subwoofer

Set "Yes" if your subwoofer conforms to the THX Ultra2 standard or if the playback capability of its bass range extends down to 20 Hz. Otherwise, set "No."

b. Boundary Gain Compensation

Room boundaries (walls) or other characteristics (such as wall construction) may increase the perceived acoustics levels at low frequencies. Depending on the listener's and the subwoofer's position, the listener may experience an excessive bass effect.

The purpose of this feature is to compensate for excessive bass resulting from a boundary gain effect.

ON: Boundary Gain Compensation is applied.

OFF: Boundary Gain Compensation is not applied.

c. Distance between Surr Back Sp

Measure the distance between your two surround back speakers and then choose the setting that corresponds to your measurement: "0-30 cm (0-12 inch)," ">30-122 cm (>12-48 inch)," or ">122 cm (>48 inch)". For optimum ASA effect, the surround back speakers should be placed as close together as possible.

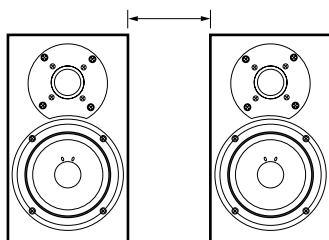

1-5. LFE Level Setup sub-menu

This sub-menu is for setting the LFE (Low Frequency Effect) levels included in Dolby Digital, DTS, and MPEG Multi software. The default setting is 0 decibels.

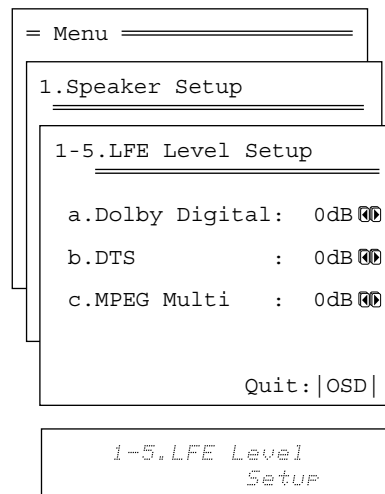

a. Dolby Digital

The level can be adjusted to either $-\infty$ or between -10 and 0 decibels in 1-decibel increments. For Dolby Digital input source signals, the LFE level becomes that set here. A setting of 0 decibels is recommended for optimum performance; however, if the low frequency range is too strong, lower this setting as necessary.

b. DTS

The level can be adjusted to either $-\infty$ or between -10 and 0 decibels in 1-decibel increments. For DTS input source signals, the LFE level becomes that set here. A setting of 0 decibels is recommended for optimum performance; however, if the low frequency range is too strong, lower this setting as necessary.

c. MPEG Multi

The level can be adjusted to either $-\infty$ or between -10 and 0 decibels in 1-decibel increments. For MPEG input source signals, the LFE level becomes that set here. A setting of 0 decibels is recommended for optimum performance; however, if the low frequency range is too strong, lower this setting as necessary.

Input Setup

2-1. Digital Setup sub-menu

b. Digital Format

The default setting is "All." If "----" is selected for this input source at the Digital Input setting, then this setting will not appear. Although you can use this default setting as is, you may change it as desired depending on the input signal format (e.g., if you know that you will always be listening to a certain input signal format from a particular input source).

All: Detects input signal format automatically. The Dolby Digital, DTS, MPEG Multi, and PCM signals are automatically detected and decoded appropriately. If there are no digital input signal, the input signal coming into analog input jack will be played.

AC-3RF: Select this option when you play only AC-3RF signal which comes from AC-3RF output jack on a LD player to the AC-3RF input jack on you unit. When using this option, signals from other input jack will not be played. This option can be selected when you select the VIDEO 4 for input source.

DTS: Select this option when you only decode DTS signal. Other format signals will not be played.

PCM: Select this option when you only decode PCM signal. Other format signals will not be played.

Note:

If "All" is selected and a compact disc or LD is fast-forwarded during playback, decoded PCM signals may produce a skipping sound. In such cases, change the setting to "PCM."

Notes on DTS:

- If you play a CD or LD that supports DTS when the "PCM" setting is selected on the this unit, the DTS encoded signal will not be decoded and noise will be output. This noise could damage the amplifier and speakers. Therefore, be sure to selected "All" or "DTS" and use the digital input jacks (OPTICAL or COAXIAL) to connect the DTS source.
- If you play a CD or LD that supports DTS when the "All" setting is selected, you may hear a noise for a short while until the DTS decoder recognizes the DTS-encoded signal and starts operating. This is not a malfunction.
- If you press the "pause" or "skip" button on the player while playing a DTS source, a short noise may be heard. This is not a malfunction. In such cases, try playing the source in the "DTS" selected.
- The DTS indicator on this unit lights while a DTS source is played. When playback finishes and the DTS signal transmission stops, this unit remains in DTS mode and the DTS indicator remains lit. This prevents noise when you operate the "pause" or "skip" button on the player. Therefore, if the source is immediately switched from DTS to PCM, the PCM signal may not be played. In this case, stop the playback of the source on the player for about three seconds and then resume playback.
- You may not be able to play some DTS source signals from certain CD players and LD players even if you connect the player to this unit digitally. This is because the digital signal has been processed (such as the output level, sampling frequency, or frequency response) and this unit cannot recognize the signal as DTS data. Therefore you may hear noise when you play a DTS source while processing the signal.
- The outputs for the VIDEO 1 OUT, VIDEO 2 OUT, TAPE 1 OUT, and TAPE 2 OUT output analog audio signals. Do not record from CDs or LDs that support DTS using these outputs. If you do, the DTS-encoded signal will be recorded as noise.

2-4. Listening Mode Preset sub-menu

With the this unit, you can set a different listening mode for each different signal format that comes from each input source and also set the parameters for the listening mode itself. For example, if your DVD player also plays compact discs and the DVD video signal is DTS and the compact disc signal is PCM, then you can set a different listening mode for each.

This is especially convenient if you frequently play the same types of movies or music.

Note that some listening modes cannot be set for some input sources. In addition, if "multi channel" is set for the input source selected, then the listening mode cannot be set. Also, if the "----" is set for the Digital Input setting in the Digital Setup sub-menu, then you can only select "Analog/PCM."

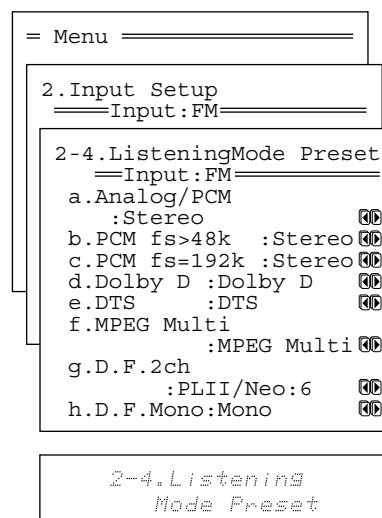

5.1-channel digital surround format

The 5.1-channel digital surround format has a variety of versions including Dolby Digital, DTS, and MPEG Multichannel. The 5.1- channel digital surround format enables you to individually record and play five full-range (20Hz-20kHz) channels (left and right front, center, two surround channels) plus an LFE channel (Low Frequency Effect) for the low-range effect sound. It will create a realistic sound that could be heard in the theaters and concert halls.

Input Setup

Relationship between input source and listening mode

Listening modes marked with the "●" can be selected. For columns that list a number of listening modes, the display will correspond to the format of the signal from the source media.

Input source signal (display)	a. Analog/PCM	b. PCM fs > 48k	c. PCM fs = 192k	d. Dolby D (Dolby Digital)	e. DTS
Type software	Tape, CD Record, Tuner	Audio DVD Video DVD	Audio DVD	Video DVD, LD	CD, LD Video DVD
Listening mode					
Mono	●				
Direct	●	●	●		
Stereo	●	●	●	●	●*
T-D (Theater-Dimensional)	●			●	●
Dolby Digital				●	
Dolby EX				Dolby Digital EX	
DTS					DTS DTS-ES Matrix 6.1 DTS-ES Discrete 6.1 DTS 96/24
MPEG (MPEG Multichannel)					
Dolby Pro Logic II DTS Neo:6	PL II Movie PL II Music DTS Neo:6 Cinema DTS Neo:6 Music	PL II Movie PL II Music			
THX (THX Cinema)	THX (THX Cinema)			THX (THX Cinema) THX Surround EX THX Ultra2 Cinema THX MusicMode	THX (THX Cinema) THX Ultra2 Cinema THX MusicMode
Mono Movie	●				
Enhanced 7	●			●	●
Orchestra	●			●	●
Unplugged	●			●	●
Studio-Mix	●			●	●
TV Logic	●			●	●
All Ch Stereo	●				

Input source signal (display)	f. MPEG Multi	g. D.F.2ch (Digital Format 2ch)	h. D.F.Mono (Digital Format Mono)
Type software	Video DVD	Video DVD LD	Video DVD LD
Listening mode			
Mono		●	●
Direct			
Stereo	●	●*	
T-D (Theater-Dimensional)	●	●	
Dolby Digital			
Dolby EX	Dolby EX		
DTS			
MPEG (MPEG Multichannel)	●		
Dolby Pro Logic II DTS Neo:6		●	
THX (THX Cinema)	THX (THX Cinema) THX Surround EX THX Ultra2 Cinema THX MusicMode	THX (THX Cinema)	
Mono Movie		●	●
Enhanced 7	●	●	
Orchestra	●	●	
Unplugged	●	●	
Studio-Mix	●	●	
TV Logic	●	●	
All Ch Stereo		●	

* When playing sources recorded in DTS 96/24 format, "DTS 96/24 Stereo" is displayed.

Input Setup

Input source signals

a. Analog/PCM

Analog sources consist of LP records, FM and AM broadcasts, cassette tapes, and the such. PCM (Pulse Code Modulation) is one form of digital audio signals and is recorded directly onto compact discs and DVDs without compression.

b. PCM fs > 48 k

Digital PCM sources that are recorded at a sampling rate of greater than 48 kilohertz. This includes DVDs that are recorded with high quality audio.

c. PCM fs = 192 k

Digital PCM sources that are recorded at a sampling rate of 192 kilohertz. This includes DVDs that are recorded with extremely high quality audio.

d. Dolby D (Dolby Digital)

Digital data with AC-3 compression and a maximum of 5.1-channel surround sound. This source signal comes from DVDs and LDs that have the  mark and therefore recorded for 5.1-channel output.

Dial norm

Dialogue Normalization (Dial Norm) is feature of Dolby Digital. When playing back software that has been encoded in Dolby Digital, sometimes you may see a brief message in the front panel display that read Dial Norm xdB ("x" being a numeric value). Dialogue Normalization serves to let you know if the source material has been recorded at a higher or lower level than usual. For example, if you see the message "Dial Norm: +4" in the front panel display, to keep the overall output level constant just turn down the volume control by 4 dB. In other words, the source material that you are listening to has been recorded 4 dB louder than usual. If you do not see a message, then no adjustment of the volume control is necessary.

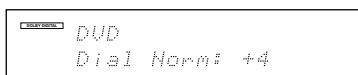

e. DTS

DTS (Digital Theater System) is compressed digital data with a maximum 6.1-channel surround output that allows for an extremely high-quality sound. This source signal requires a DVD player that supports DTS output and comes from DVDs, compact discs, and LDs that have the  mark.

f. MPEG Multi

Digital data with a maximum of 5.1-channel surround audio with MPEG compression. This source signal comes from DVDs that have the  mark.

g. D.F. 2 ch (Digital Format 2 channel)

2 channel digital signal (except for PCM) such as Dolby Digital. DVD or LD in which the 2 channel sound are recorded may be this type of input signal.

h. D.F. Mono (Digital Format Monaural)

Monaural digital signal (except for PCM) such as Dolby Digital. DVD or LD in which the monaural sound are recorded may be this type of input signal.

Listening Modes

Mono

This mode is for playing old movies whose sound is recorded in monaural or playing left and right channels separately in the movies which contains the different language signals recorded into individual channels. This mode also allows you to listen to the multiplexed soundtracks on DVDs, and other media that have them.

Direct

This mode delivers pure sound with minimum sound quality adjustment and filtration. The sound recorded for the right and left front channels is output to the right and left front speakers only and not output to the subwoofer.

Stereo

This mode has all input sound is output from the left and right front speakers. Subwoofer also can be used for playback.

T-D (Theater-Dimensional)

For the best enjoyment of your home theater, it is recommended that you have at least front left and right speakers, a center speaker, and surround left and right speakers. However, if you only have front left and right speakers, you can enjoy multichannel audio by using this mode.

This mode controls the characteristics of the sound that reaches each ear to reproduce a multi-speaker setup. To receive the full effect, there is an optimum listening position (sweet spot). Refer to the explanation of the listening angle. In addition, if the reflective sound components are large, it may be difficult to achieve the desired result, so be sure to set up your system and listening position to minimize reflective sound.

Dolby D (Dolby Digital)

The Dolby D mode is used to play Dolby Digital sources.

- **Dolby Digital EX**
Enabled when playing back sources with surround tracks that were encoded using the Surround EX technology.
- **Dolby EX**
Select to achieve the same effects as Dolby Digital EX encoded sources with non-Dolby Digital sources.

DTS

The DTS mode is used to play DTS sources.

- **DTS 96/24**
Automatically changes to this mode when playing back sources with surround tracks that were encoded using the DTS 96/24 technology.
- **DTS-ES Discrete 6.1**
With the addition of the surround back channel, this new format has all 6.1 channels recorded independently for a completely digital format. Since all channels are recorded independently, high-fidelity surround playback with the increased feeling of a separated sound space is achieved.
- **DTS-ES Matrix 6.1**
This format has the surround back channel matrix encoded and inserted into the left and right surround channels so that at playback the output for the left, right, and back surround channels are decoded using a high-precision matrix decoder.

MPEG Multi (MPEG Multichannel)

Used for playing MPEG multi channel source.

Input Setup

THX

This mode is for playing back sources using THX. For excellent fidelity when playing back THX sounds, it is recommended to use a THX-certified speaker system.

- **THX Cinema**

This is the conventional 5.1-channel THX format. This mode should be used only when playing back sources that were mixed for playback in large movie theater environments.

- **THX Surround EX**

"THX Surround EX - Dolby Digital Surround EX" is a joint development of Dolby Laboratories and the THX division of Lucasfilm Ltd.

In a movie theater, film soundtracks that have been encoded with Dolby Digital Surround EX technology are able to reproduce an extra channel which has been added during the mixing of the program. This channel, called Surround Back, places sounds behind the listener in addition to the currently available front left, front center, front right, surround right, surround left, and subwoofer channels.

This additional channel provides the opportunity for more detailed imaging behind the listener and brings more depth, spacious ambience, and sound localization than ever before.

In order to enjoy the full effects of the THX Surround EX technology at home, you must be using a receiver or controller with the appropriate certification logo and the receiver must be set to the THX Surround EX mode. This unit can play the 5.1 ch program in THX surround EX mode, even if the program is not encoded in Dolby Digital Surround EX format. For this kind of program, the sound from surround back channels depends on a program and may not fit to your taste.

- **THX Ultra2 Cinema**

When performing 7.1 ch playback of Dolby Digital, DTS, or other 5.1 ch movie sources, the surround components are analyzed and used to create surround back channels for the optimum ambient and directional surround sound. This provides a wider sound space to the sides and rear and a heightened feeling of the sound positioning.

- **THX MusicMode**

This is a new mode provided with THX Ultra2 and meant for the playback of music software sources. 5.1 ch multi-channel music sources are converted to 7.1 ch playback with a virtual rear sound from the surround speakers and surround back speakers. The rear sound space is created with the consistency and spaciousness optimum for music playback.

Pro Logic II

Previous Dolby Pro Logic records the 4 channel signals (left and right front, center, monaural surround) into 2 channels using matrix encoding and, in playback, decodes the 2 channel signal into 4 channels. However, Dolby Pro Logic II use the feedback logic circuits to decode matrix-encoded 2 channel signal (e.g. Dolby Surround) more precisely into original channels for 5.1 ch playback.

In Pro Logic II, you can choose the Movie mode for playing movies and the Music mode for playing music.

- **Pro Logic II Movie**

In this mode, conventional narrow band monaural surround channel is played as stereo with a realistic feel of movement.

- **Pro Logic II Music**

In this mode, surround channels will produce natural sound space from 2 channel music.

The Movie mode can be used for playing the VHS or DVD video with  mark or certain TV programs. The Music mode can be used for playing music in stereo from CD and other sources.

DTS Neo:6

This mode is for 6.1 channel playback of 2 channel sources such as PCM or analog sources. All 6 channel outputs are wide frequency range with a great separation between the different channels.

This mode can be set to the Cinema mode designed for playing movies and the Music mode designed for listening to music.

- **DTS Neo:6 Cinema**

This mode is good for movies. Reproduced surround sound makes realistic feel of movement as 6.1 channel sources. This mode can be used with VHS and television programs with stereo sound.

- **DTS Neo:6 Music**

This mode uses the surround channels to provide a natural sound space that cannot be provided with normal stereo output. This mode can be used with music compact discs and other stereo sources.

Mono Movie

This mode is suitable for playing back monaural recording such as old movie soundtracks. The center channel delivers the unprocessed original sound, whereas the other channels deliver the center-channel sound processed with the appropriate reverberation. This allows you to enjoy monaural sound with the atmosphere of a movie theater.

Enhanced 7

Enhanced 7 intends to reproduce a natural surround environment by using 7-channel speakers. The sound effects moving smoothly toward the surround back. This mode is good for music and TV sports programs.

Orchestra

This mode is appropriate for classical and opera music. The center channel is cut and the surround channels are emphasized to widen the stereo image. It will simulate the natural reverberation that is created in large halls.

Unplugged

This mode is suitable for acoustical instrumental sounds, vocals, and jazz music. By emphasizing the front stereo image, it will simulate the acoustics that you would experience in front of the stage.

Studio-Mix

This mode is for rock and popular music. The lively sounds are enhanced for a powerful acoustic image that simulates the feeling of being in a club or rock concert.

TV Logic

This mode gives realistic acoustics to TV programs that are aired from TV studios. It enhances the entire surround sound and clarity of the conversation.

All Ch Stereo

This mode is designed for playing background music. The front, surround, and surround back channels create a stereo image that encompasses the entire area.

Listening Mode Setup

3. Listening Mode Setup menu

This menu allows you to make fine adjustments to the listening modes you have set for each input source with the Listening Mode Preset sub-menu. These adjustments are in the form of parameters and each one is explained below. Note that some parameters cannot be set for some listening modes and that no sub-menu will have all parameters. Also, for some input signal formats, changes in the listening mode parameters may actually result in no change to the resulting output signal.

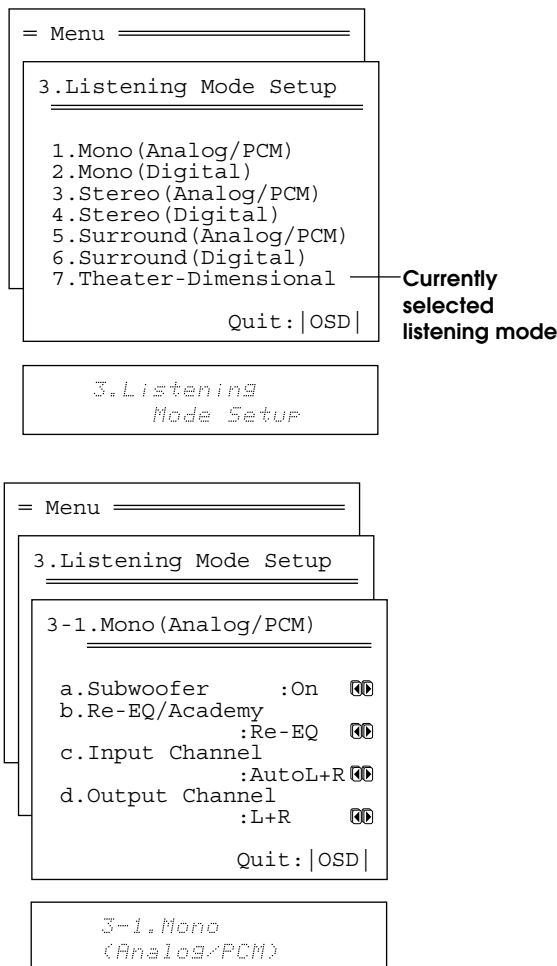

3-1. Mono (Analog/PCM) Setup

Select this to modify the Mono listening mode when the current source is analog or PCM. The parameters that can be set are shown in the table below.

	Parameter	Setting Initial value
a	Subwoofer	Off, On
b	Re-EQ/Academy	Off, Re-EQ, Academy
c	Input Channel	Auto L+R, Left, Right
d	Output Channel	L+R, Center

3-2. Mono (Digital) Setup

Select this to modify the Mono listening mode when the current source is digital. The parameters that can be set are shown in the table below.

	Parameter	Setting Initial value
a	Subwoofer	Off, On
b	Re-EQ/Academy	Off, Re-EQ, Academy
c	Input Channel	Auto L+R, Left, Right
d	Output Channel	L+R, Center

3-3. Stereo (Analog/PCM) Setup

Select this to modify the Stereo listening mode when the current source is analog or PCM. The parameters that can be set are shown in the table below.

	Parameter	Setting Initial value
a	Subwoofer	Off, On
b	Re-EQ/Academy	Off, Re-EQ, Academy
c	Upsampling	Off, On

3-4. Stereo (Digital) Setup

Select this to modify the Stereo listening mode when the current source is digital. The parameters that can be set are shown in the table below.

	Parameter	Setting Initial value
a	Subwoofer	Off, On
b	Re-EQ/Academy	Off, Re-EQ, Academy

3-5. Surround (Analog/PCM) Setup

Select this to modify the Pro Logic II or DTS Neo:6 mode when the current source is analog or PCM. The parameters that can be set are shown in the table below.

	Parameter	Setting Initial value
a	Subwoofer	Off, On
b	Re-EQ	On, Off
c	Surround Speakers	Surround L/R, Surround Back, Surround L/R+Back
d	Upsampling*	Off, On
e	Surround Mode	PL II Movie, PL II Music, DTS Neo:6 Cinema, DTS Neo:6 Music
f	PL II Music Panorama	Off, On
g	PL II Music Dimension	0, 1, 2, 3, 4, 5
h	PL II Music Center Width	0, 1, 2, 3, 4, 5
i	Neo:6 Music Center Image	0, 1, 2, 3, 4, 5

* When Upsampling is set to "On," DTS Neo:6 cannot be selected.

Listening Mode Setup

3-6. Surround (Digital) Setup

Select this to modify the Dolby D, DTS, MPEG Multi and Pro Logic II listening modes when the current source is digital. The parameters that can be set are shown in the table below.

	Parameter	Setting Initial value
a Subwoofer	Off, On	On
b Re-EQ	Off, On	Off
c Surround Speakers	Surround L/R, Surround Back, Surround L/R+Back	Surround L/R
d Dolby Digital EX (Dolby D)	Auto, On, Off	Auto
e Dolby EX (Others)	Off, On	Off
f DTS-ES	Auto, On, Off	Auto
g Surround Mode (2ch)	PL II Movie, PL II Music	PL II Movie
h PL II Music Panorama	Off, On	Off
i PL II Music Dimension	0, 1, 2, 3, 4, 5, 6	3
j PL II Music Center Width	0, 1, 2, 3, 4, 5	3

3-7. THX Setup

Select this to modify the THX listening modes; the one that is currently set is the one that is modified. The parameters that can be set are shown in the table below.

	Parameter	Setting Initial value
a Subwoofer	Off, On	On
b Re-EQ	Off, On	On*
c Surround Speakers	Surround L/R, Surround Back, Surround L/R+Back	Surround L/R
d THX Surround EX	Auto, Manual	Auto
e THX Mode	Ultra2 Cinema, Music Mode, Surround EX (DTS-ES Mtrx6.1+THX), Cinema	Ultra2 Cinema
f Decoder (Analog/PCM)	PL II Movie, DTS Neo:6 Cinema	PL II Movie

* When the unit is turned on, the parameter returns to "On."

3-7. Theater-Dimensional Setup

Select this to modify the Theater-Dimensional (T-D) listening modes. The parameters that can be set are shown in the table below.

	Parameter	Setting Initial value
a Subwoofer	Off, On	On
b Listening Angle	20deg, 40deg	20deg
c Center	Off, On	Off
d Front Expander	Off, On	On
e Virtual Surr Level	-3dB to +3dB	0dB
f Dialog Enhance	Off, On	Off

3-7. Enhanced 7 Setup

Select this to modify the Enhanced 7 listening mode. The parameters that can be set are shown in the table below.

	Parameter	Setting Initial value
a Subwoofer	Off, On	On
b Re-EQ	Off, On	Off
c Front Effect	Off, On	On
d Reflect Level	-5dB to +5dB	0dB
e Reverb Level	-5dB to +5dB	0dB
f Room Size	Small, Mid-small, Middle, Mid-large, Large	Middle

3-7. Orchestra Setup, Unplugged Setup, Studio-Mix Setup, TV Logic Setup

Select this to modify the Orchestra, Unplugged, Studio-Mix, and TV Logic listening modes; the one that is currently set is the one that is modified. The parameters that can be set are shown in the table below.

	Parameter	Setting Initial value
a Subwoofer	Off, On	On
b Re-EQ	Off, On	Off
c Surround Speakers	Surround L/R, Surround Back, Surround L/R+Back	Surround L/R
d Front Effect	Off, On	On
e Reflect Level	-5dB to +5dB	0dB
f Reverb Level	-5dB to +5dB	0dB
g Room Size	Small, Mid-small, Middle, Mid-large, Large	Middle

3-7. All Ch Stereo Setup

Select this to modify the All Ch Stereo listening mode. The parameters that can be set are shown in the table below.

	Parameter	Setting Initial value
a Subwoofer	Off, On	On
b Re-EQ	Off, On	Off

3-7. Mono Movie Setup

Select this to modify the Mono Movie listening mode. The parameters that can be set are shown in the table below.

	Parameter	Setting Initial value
a Subwoofer	Off, On	On
b Re-EQ/Academy	Off, Re-EQ, Academy	Off
c Surround Speakers	Surround L/R, Surround Back, Surround L/R+Back	Surround L/R
d Front Effect	Off, On	On
e Reflect Level	-5dB to +5dB	0dB
f Reverb Level	-5dB to +5dB	0dB
g Room Size	Small, Mid-small, Middle, Mid-large, Large	Middle

Listening Mode Setup

Description listening mode parameters

Subwoofer

Set this to "Off" if you are not using a subwoofer (even if one is connected). If "No" is selected for the Subwoofer setting in the Speaker Config sub-menu, then this setting will not appear.

Re-EQ/Academy

Depending on the listening mode, you can either turn Re-EQ on or off, or you can select "Re-EQ," "Academy," or "Off."

Re-EQ: Re-EQ (re-equalization) takes the edginess or "brightness" out of your home cinema sound to compensate for the fact that sound mixed for theaters may sound too bright when played back through speakers in the home environment.

Academy: Older monaural film mixes relied on high-frequency rolloff in presentation to sound properly balanced, so that excessive hiss from the grain structure of the film would not be heard. The high-frequency loss was typically due to a combination of optical slit loss, electrical filters, loudspeaker response, and screen loss. Some films have been transferred to video without such a high-frequency rolloff, and thus sound overly bright and hissy. This unit includes this "Academy filter," which is based on contemporary playback practices for such films over wide-range systems.

On: Select to turn on the Re-EQ.

Off: Select to turn off both the Re-EQ and Academy filters.

Input Channel

This allows you to set which input channel to use for monaural sound.

Auto L+R: Select this under normal circumstances.

When the input source is center channel only, this channel is used for monaural sound input channel. Otherwise, left and right channels are mixed and the mixed signal is used for monaural sound input channel.

Left/Right: You will need to select either left or right when playing a video source that contains bilingual data. In such a case, the left and right channels will contain different language. Select the channel with the language you desire.

Output Channel

This allows you to set which output channel to use for monaural sound. If "None" is selected for the Center Speaker setting in the Speaker Config sub-menu, then this setting will not appear.

Auto L+R: The monaural sound is split between the left and right channels.

Center: The monaural sound is output from the front center channel.

Surround Speakers

This setting allows you to decide through which speakers to output the sound meant for the surround speakers during 5.1-channel output when seven speakers are connected to this unit.

Note:

If you have two surround back speakers placed very close together and you select "Surround Back" or "Surr L/R+Back," then you may not achieve the desired left-right separation of the sound space. In this case, "Surround L+R" is recommended.

Surround L/R: This outputs the sound to the surround left and right speakers as normal and outputs nothing to the surround back left and right speakers.

Surround Back: This outputs the sound to the surround back left and right speakers and outputs nothing to the surround left and right speakers.

Sur L/R+Back: This outputs the sound to both the surround left and right speakers and the surround back left and right speakers.

Upsampling

Upsampling processes the input digital signal or the converted digital signal from analog input source and converts their digital sampling frequency to twice the current frequency for an even further detailed sound reproduction. This can be set to either "On" or "Off."

Surround Mode

Selects the Surround Mode for analog or PCM source. Available options are PL II Movie (Pro Logic II Movie), PL II Music (Pro Logic II Music), DTS Neo:6 Cinema, and DTS Neo:6 Music.

You can change the Surround Mode settings easily using the remote controller. When you set the listening mode to Pro Logic II or DTS Neo:6, each press of the SURROUND button on the remote controller cyclically changes the Surround mode in the order of PL II Movie, PL II Music, DTS Neo:6 Cinema, and DTS Neo:6 Music.

Surround Mode (2ch)

Selects the Surround Mode for 2 ch digital source (except for PCM). Available options are PL II Movie and PL II Music. You cannot select Neo:6 Cinema and Neo:6 Music.

Pro Logic II Music Panorama

Use this listening mode to expand sound space in front of a listener to both side of the listener.

On: Turns on the PL II Music Panorama mode.

Off: Turns off the PL II Music Panorama mode.

Pro Logic II Music Dimension

Use this listening mode to modify the sound space location forward or backward.

The setting of "3" is the normal position and setting to "2" or lower moves the sound space forward and setting to "4" or higher move the sound space backward.

If the stereo recording has excessive broadness or too strong surroundness, move the sound space forward to get the appropriate sound balance. In contrast, if the stereo recording is somewhat felt like monaural or has narrowness, move the sound space backward to get more surroundness.

Pro Logic II Music Center Width

In Pro Logic II decoding, outstanding center signal will be output only from center speaker. When the center speaker is not used, the decoder divide the center signal equally to each front left and right speakers to create "phantom" center sound image.

The Pro Logic II Music Center Width mode allows you to adjust where the center sound image is heard from. Depending on your setting, the center sound image will be heard from center speaker only, front left and right speakers (as phantom center sound image), or all three speakers (center, front left and right) in various level combinations. For home use, applying some "width" to center signal will improve the level balance for center and main speakers, and effect the width of the center sound image, or "mass" of the sound. Many of sound recordings processed for stereo playback will be reproduced better by controlling the parameter for this listening mode. The recommended setting for Pro Logic II Music mode is "3." This allows you to easily distinguish the Pro Logic II Music mode from the Pro Logic II Movie mode whose setting is automatically set to "0."

Listening Mode Setup

Neo:6 Music Center Image

DTS Neo:6 derives a center channel from two-channel PCM and analog sources.

In cinema mode, for Lt/Rt film soundtracks, sounds steered to the center are subtracted from the left and right channels.

In music mode, the intent in the front channels is less one of steering and more one of stabilizing the front image by augmenting it with a center channel, while preserving the original perspective of the stereo mix. Therefore the derived center is never fully subtracted from the left and right channels.

Center Image is the factor controlling the amount of subtraction. It varies between 0 and 5 in steps of 1 and the default value is 3.

When Center Image=5, the factor is zero and nothing is subtracted from the left and right channels. When Center Image=0, the center channel is subtracted from the left and right channels at half level (-6 dB) for each channel. The signal level sent to the center channel output is not affected by Center Image.

This control should be set based on room layout and personal preferences. A setting of 5 allows the left and right channels to pass through unaltered from the stereo mix. A setting of 0 gives more center channel dominance, which is particularly desirable if listeners are located well off-center. At any setting, the center speaker anchors the image.

Center Image is only enabled when the listening mode is DTS Neo:6 Music.

Dolby Digital EX (Dolby D)

If you have surround back speakers connected, use this setting to select whether or not you will use Dolby EX playback.

Auto: When the source has an EX flag (ID signal for Surround EX), the playback is automatically changed to Dolby Digital EX. If the source has no EX flag, the playback is changed to Dolby Digital.

On: The playback is set to Dolby Digital EX.

Off: The playback is set to normal Dolby Digital.

If your surround channel is monaural or you do not have a surround channel, then the playback will be normal Dolby Digital regardless of the above setting.

You can change the Dolby Digital EX mode settings easily using the remote controller. While playing a Dolby Digital source, after selecting Dolby D for listening mode, each press of the SURROUND button on the remote controller cyclically changes the Dolby Digital EX mode in the order of "Auto," "On," and "Off."

Dolby EX (Others)

If you have surround back speakers connected, use this setting to select whether or not you will use Dolby EX playback for MPEG multi-channel sources.

On: For playback of MPEG multi-channel sources with Dolby EX effects added.

Off: For normal playback of MPEG multi-channel sources.

You can change the Dolby EX mode settings easily using the remote controller. While playing a MPEG Multichannel source, after selecting Dolby EX for listening mode, each press of the SURROUND button on the remote controller cyclically changes the Dolby EX mode in the order of "On," or "Off."

DTS-ES

Selects DTS-ES mode.

Auto: When the DTS source has the DTS-ES flag (ID signal for DTS-ES), the listening mode is automatically changed to DTS-ES Discrete 6.1 or DTS-ES Matrix 6.1. If the DTS source has no DTS-ES flag, the mode is changed to DTS 5.1.

On: When the DTS source has the DTS-ES flag, the listening mode is automatically changed to DTS-ES Discrete 6.1 or DTS-ES Matrix 6.1. If the DTS source has no DTS-ES flag, the mode is forced to be DTS-ES Matrix 6.1.

Off: Even when the DTS source has the DTS-ES flag, the DTS-ES listening modes are not used. The DTS sources are always played in DTS 5.1 mode.

You can change the DTS-ES mode settings easily using the remote controller. While playing a DTS source, after selecting DTS for listening mode, each press of the SURROUND button on the remote controller cyclically changes the DTS-ES mode in the order of "Auto," "On," and "Off."

THX Surround EX

Selects THX Surround EX mode when the input signal is Dolby Digital.

Auto: When the Dolby Digital source has the EX flag (ID signal for Surround EX), the listening mode is automatically changed to THX Surround EX mode. When the Dolby Digital source has no flag, the mode for the THX Mode setting below is used. Also, if a DTS source with a DTS-ES flag (ID signal for DTS-ES) is being played, THX Cinema effects for that DTS-ES playback format will be added.

Manual: Even when the source has the EX flag, the mode for the THX Mode setting below is used.

THX Mode

Selects THX mode.

Ultra2 Cinema: Playback is set to THX Ultra2 Cinema.

MusicMode: Playback is set to THX MusicMode.

Surround EX or DTS-ES Mtrx6.1+THX: Playback is set to THX Surround EX. For DTS sources, the playback is DTS-ES Discrete 6.1 or DTS-ES Matrix 6.1 according to the EX flag.

Cinema: Playback is set to THX Cinema.

These settings can be changed easily using the remote controller (unless THX Surround EX setting is Auto and the playback source has an EX or ES flag). With THX mode set for the listening mode, press the THX button on the remote controller to cycle the mode from Ultra2 Cinema → MusicMode → Surround EX (for DTS sources: DTS-ES Mtrx 6.1+THX) → Cinema → and back.

Decoder (Analog/PCM)

Select the decoding mode before the THX processing.

PL II Movie: Decodes Dolby Pro Logic II Movie.

DTS Neo:6 Cinema: Decodes DTS Neo:6 Cinema.

Listening Mode Setup

Listening angle

The listening angle is the angle subtended by the front left and right speakers as seen from the listener. The setting of 20 and 40 degrees are only for nominal purposes, so select the setting that is closest to your actual listening angle.

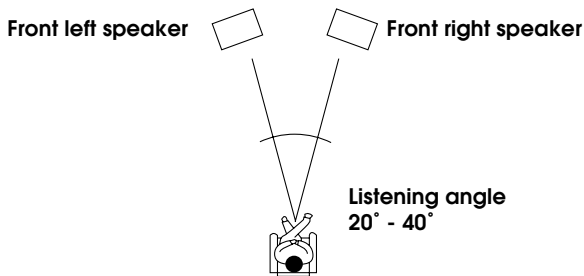

Reverb Lvl (Level)

This parameter allows you to adjust the depth of acoustic reverberation to match the playback source material, the acoustics of your room, and such other factors. This can be set between -5 and +5 decibels in 1-decibel increments.

Room Size

This parameter allows you to set virtual hall size to simulate for each surround mode. You can choose from "Large," "Mid-Large," "Middle," "Mid-Small," or "Small."

Center

For systems that have a center speaker, the center channel signal can be output from the center speaker. For instance, in systems where the front left and right speakers are small, use of the center speaker may provide a better sound space. (If your system uses a center speaker, be sure to perform the level calibration with the left and right speakers in the Speaker Setup menu beforehand.)

On: The center channel signal is output to the center speaker.

Off: The center channel signal is output from the front left and right speakers (Phantom Center).

Front Expander

The front expander function spreads out the sound from the front speakers for the feeling of a wide sound space.

On: Select to turn on the front expander function to simulate a wider sound space.

Off: Select to turn off the front expander function for a normal sound space.

Virtual Surr Lvl (Level)

This parameter adjusts the virtual surround level. This can be set from -3 to +3 decibels.

Dialog Enhance

This parameter allows you to adjust the dialog sound level from the center speaker if it is difficult to hear.

On: Enhances the vocal ranges for the center channel signal.

Off: Outputs the center channel signal at the regular level and frequency characteristics.

Front Effect

Some live recordings contain acoustic reverberation. When you play these sources, more reverberation will be applied by the DSP, creating too much reverb effects and the sound loses form or presence. In this case, set this setting to "Off." No reverberation from the DSP will be applied to the sound output from the three front channels, so the sound source is played as it is without any further reverberation.

Reflect Lvl (Level)

This parameter allows you to adjust the strength of direct sound reflections to match the playback source material, the acoustics of your room, and such other factors. This can be set between -5 and +5 decibels in 1-decibel increments.

Listening Mode Setup

Relationship between listening mode and parameter

Listening mode Parameter	Mono		Direct	Stereo		Theater Dimensional (T-D)	(Surround)	
	(Analog/ PCM)	(Digital format monaural or 2ch)		(Analog /PCM)	(Digital) Dolby D DTS MPEG Multi		(Digital) Dolby D DTS MPEG Multi	(Analog/PCM) Pro Logic II DTS Neo:6
Subwoofer	●	●		●	●	●	●	●
Re-EQ (/Academy)	●	●		●	●		●	●
Input Channel	●	●						
Output Channel	●	●						
Surround Speakers							●	●
Upsampling				●				●
DTS-ES							●	
THX Surround EX (Dolby D)								
THX Surround EX (Others)								
Surround Mode								●
Surround Mode (2ch)							●	
PL II Music Panorama							●	●
PL II Music Dimention							●	●
PL II Music Center Width							●	●
Neo:6 Music Center Image								●
Front Effect								
Reflect Level								
Reverb Level								
Room Size								
Listening Angle						●		
Center						●		
Front Expander						●		
Virtual Surr Level						●		
Dialog Enhance						●		
Dolby Digital EX (Dolby D)							●	
Dolby Digital EX (Others)							●	
THX Movie								
Decoder (Analog/PCM)								

Listening mode Parameter	THX PL II THX	Mono Movie	Enhanced 7	Orchestra/ Unplugged/ Studio-Mix/ TV Logic/	All Ch Stereo
Subwoofer	●	●	●	●	●
Re-EQ (/Academy)	●	●	●	●	●
Input Channel					
Output Channel					
Surround Speakers	●	●		●	
Upsampling					
DTS-ES					
THX Surround EX (Dolby D)	●				
THX Surround EX (Others)	●				
Surround Mode					
Surround Mode (2ch)					
PL II Music Panorama					
PL II Music Dimention					
PL II Music Center Width					
Neo:6 Music Center Image					
Front Effect		●	●	●	
Reflect Level		●	●	●	
Reverb Level		●	●	●	
Room Size		●	●	●	
Listening Angle					
Center					
Front Expander					
Virtual Surr Level					
Dialog Enhance					
Dolby Digital EX (Dolby D)					
Dolby Digital EX (Others)					
THX Movie	●				
Decoder (Analog/PCM)	●				

Free Manuals Download Website

<http://myh66.com>

<http://usermanuals.us>

<http://www.somanuals.com>

<http://www.4manuals.cc>

<http://www.manual-lib.com>

<http://www.404manual.com>

<http://www.luxmanual.com>

<http://aubethermostatmanual.com>

Golf course search by state

<http://golfingnear.com>

Email search by domain

<http://emailbydomain.com>

Auto manuals search

<http://auto.somanuals.com>

TV manuals search

<http://tv.somanuals.com>