

Multi-Platform Tuner

TUN-3.7

Instruction Manual

Integra

WARNING:

TO REDUCE THE RISK OF FIRE OR ELECTRIC SHOCK, DO NOT EXPOSE THIS APPARATUS TO RAIN OR MOISTURE.

CAUTION:

TO REDUCE THE RISK OF ELECTRIC SHOCK, DO NOT REMOVE COVER (OR BACK). NO USER-SERVICEABLE PARTS INSIDE. REFER SERVICING TO QUALIFIED SERVICE PERSONNEL.



WARNING
RISK OF ELECTRIC SHOCK
DO NOT OPEN

AVIS
RISQUE DE CHOC ELECTRIQUE
NE PAS OUVRIR



The lightning flash with arrowhead symbol, within an equilateral triangle, is intended to alert the user to the presence of uninsulated "dangerous voltage" within the product's enclosure that may be of sufficient magnitude to constitute a risk of electric shock to persons.



The exclamation point within an equilateral triangle is intended to alert the user to the presence of important operating and maintenance (servicing) instructions in the literature accompanying the appliance.

Important Safety Instructions

1. Read these instructions.
2. Keep these instructions.
3. Heed all warnings.
4. Follow all instructions.
5. Do not use this apparatus near water.
6. Clean only with dry cloth.
7. Do not block any ventilation openings. Install in accordance with the manufacturer's instructions.
8. Do not install near any heat sources such as radiators, heat registers, stoves, or other apparatus (including amplifiers) that produce heat.
9. Do not defeat the safety purpose of the polarized or grounding-type plug. A polarized plug has two blades with one wider than the other. A grounding type plug has two blades and a third grounding prong. The wide blade or the third prong are provided for your safety. If the provided plug does not fit into your outlet, consult an electrician for replacement of the obsolete outlet.
10. Protect the power cord from being walked on or pinched particularly at plugs, convenience receptacles, and the point where they exit from the apparatus.
11. Only use attachments/accessories specified by the manufacturer.
12. Use only with the cart, stand, tripod, bracket, or table specified by the manufacturer, or sold with the apparatus. When a cart is used, use caution when moving the cart/apparatus combination to avoid injury from tip-over.

PORTABLE CART WARNING
S3125A
13. Unplug this apparatus during lightning storms or when unused for long periods of time.
14. Refer all servicing to qualified service personnel. Servicing is required when the apparatus has been damaged in any way, such as power-supply cord or plug is damaged, liquid has been spilled or objects have fallen into the apparatus, the apparatus has been exposed to rain or moisture, does not operate normally, or has been dropped.
15. Damage Requiring Service
Unplug the apparatus from the wall outlet and refer servicing to qualified service personnel under the following conditions:
 - A. When the power-supply cord or plug is damaged,
 - B. If liquid has been spilled, or objects have fallen into the apparatus,
 - C. If the apparatus has been exposed to rain or water,
 - D. If the apparatus does not operate normally by following the operating instructions. Adjust only those controls that are covered by the operating instructions as an improper adjustment of other controls may result in damage and will often require extensive work by a qualified technician to restore the apparatus to its normal operation,
 - E. If the apparatus has been dropped or damaged in any way, and
 - F. When the apparatus exhibits a distinct change in performance this indicates a need for service.
16. Object and Liquid Entry
Never push objects of any kind into the apparatus through openings as they may touch dangerous voltage points or short-out parts that could result in a fire or electric shock.
The apparatus shall not be exposed to dripping or splashing and no objects filled with liquids, such as vases shall be placed on the apparatus.
Don't put candles or other burning objects on top of this unit.
17. Batteries
Always consider the environmental issues and follow local regulations when disposing of batteries.
18. If you install the apparatus in a built-in installation, such as a bookcase or rack, ensure that there is adequate ventilation.
Leave 20 cm (8") of free space at the top and sides and 10 cm (4") at the rear. The rear edge of the shelf or board above the apparatus shall be set 10 cm (4") away from the rear panel or wall, creating a flue-like gap for warm air to escape.

Precautions

1. **Recording Copyright**—Unless it's for personal use only, recording copyrighted material is illegal without the permission of the copyright holder.
2. **AC Fuse**—The AC fuse inside the unit is not user-serviceable. If you cannot turn on the unit, contact your Integra/Onkyo dealer.
3. **Care**—Occasionally you should dust the unit all over with a soft cloth. For stubborn stains, use a soft cloth dampened with a weak solution of mild detergent and water. Dry the unit immediately afterwards with a clean cloth. Don't use abrasive cloths, thinners, alcohol, or other chemical solvents, because they may damage the finish or remove the panel lettering.

4. Power

WARNING

BEFORE PLUGGING IN THE UNIT FOR THE FIRST TIME, READ THE FOLLOWING SECTION CAREFULLY.

AC outlet voltages vary from country to country. Make sure that the voltage in your area meets the voltage requirements printed on the unit's rear panel (e.g., AC 230 V, 50 Hz or AC 120 V, 60 Hz).

The power cord plug is used to disconnect this unit from the AC power source. Make sure that the plug is readily operable (easily accessible) at all times.

For American Models

Pressing the [Standby/On] button to select Standby mode does not fully shutdown the unit. If you do not intend to use the unit for an extended period, remove the power cord from the AC outlet.

5. **Never Touch this Unit with Wet Hands**—Never handle this unit or its power cord while your hands are wet or damp. If water or any other liquid gets inside this unit, have it checked by your Integra/Onkyo dealer.
6. **Handling Notes**
 - If you need to transport this unit, use the original packaging to pack it how it was when you originally bought it.
 - Do not leave rubber or plastic items on this unit for a long time, because they may leave marks on the case.
 - This unit's top and rear panels may get warm after prolonged use. This is normal.
 - If you do not use this unit for a long time, it may not work properly the next time you turn it on, so be sure to use it occasionally.

Memory backup

The TUN-3.7 uses a battery-less memory backup system in order to retain radio presets and other settings when it's unplugged or in the case of a power failure. Although no batteries are required, the TUN-3.7 must be plugged into an AC outlet in order to charge the backup system.

Once it has been charged, the TUN-3.7 will retain the settings for several weeks, although this depends on the environment and will be shorter in humid climates.

For U.S. models

FCC Information for User

CAUTION:

The user changes or modifications not expressly approved by the party responsible for compliance could void the user's authority to operate the equipment.

NOTE:

This equipment has been tested and found to comply with the limits for a Class B digital device, pursuant to Part 15 of the FCC Rules. These limits are designed to provide reasonable protection against harmful interference in a residential installation.

This equipment generates, uses and can radiate radio frequency energy and, if not installed and used in accordance with the instructions, may cause harmful interference to radio communications. However, there is no guarantee that interference will not occur in a particular installation. If this equipment does cause harmful interference to radio or television reception, which can be determined by turning the equipment off and on, the user is encouraged to try to correct the interference by one or more of the following measures:

- Reorient or relocate the receiving antenna.
- Increase the separation between the equipment and receiver.
- Connect the equipment into an outlet on a circuit different from that to which the receiver is connected.
- Consult the dealer or an experienced radio/TV technician for help.

For Canadian Models

NOTE: THIS CLASS B DIGITAL APPARATUS COMPLIES WITH CANADIAN ICES-003.

For models having a power cord with a polarized plug:

CAUTION: TO PREVENT ELECTRIC SHOCK, MATCH WIDE BLADE OF PLUG TO WIDE SLOT, FULLY INSERT.

Modèle pour les Canadiens

REMARQUE: CET APPAREIL NUMÉRIQUE DE LA CLASSE B EST CONFORME À LA NORME NMB-003 DU CANADA.

Sur les modèles dont la fiche est polarisée:

ATTENTION: POUR ÉVITER LES CHOCs ÉLECTRIQUES, INTRODUIRE LA LAME LA PLUS LARGE DE LA FICHE DANS LA BORNE CORRESPONDANTE DE LA PRISE ET POUSSER JUSQU'AU FOND.

Thank you for purchasing an Integra Multi-Platform Tuner. Please read this manual thoroughly before making connections and plugging in the unit.

Following the instructions in this manual will enable you to obtain optimum performance and listening enjoyment from your new Tuner.

Please retain this manual for future reference.

Features

General

- Tuner board slot
- 12V trigger IN/OUT
- IR IN/OUT
- RS232 port for interface control
- Hi-rigidity, anti-resonant chassis
- Aluminum front panel
- RI (Remote Interactive) capable

With C-HDXM Tuner Board Installed

- HD Radio reception and XM Satellite Radio
- RDS (Radio Data System)
- Automatic AM/FM/XM tuning
- 40 AM/FM/XM presets
- Preset auto scan
- Direct tuning
- Ground isolation circuit for digital/analog

With C-AMFM Tuner Board Installed

- Automatic AM/FM tuning
- 40 AM/AM presets
- Preset auto scan
- Direct tuning



HD Radio™ Technology
Manufactured Under
License From iBiquity
Digital Corporation.

“iBiquity Digital” and the “HD Radio” and “HD” Symbols are registered trademarks of iBiquity Digital Corporation. “HD Radio” is a trademark of iBiquity Digital Corporation. U.S. and Foreign Patents.

The XM name and related logos are registered trademarks of XM Satellite Radio Inc.



XM Ready®, XM Public Radio™ are trademarks of XM Satellite Radio Inc. ©2006 XM Satellite Radio Inc. All rights reserved. All other trademarks are the property of their respective owners.

Contents

Introduction

Important Safety Instructions	2
Precautions	3
Features	4
Supplied Accessories	6
Before Using the TUN-3.7	6
Connecting the Supplied Power Cord	6
Installing the Batteries	7
Aiming the Remote Controller	7
Getting to Know the TUN-3.7	8
Front Panel	8
Display	9
Setting the Display Brightness	9
Rear Panel	10
Remote Controller	11
Remote Controller	11
Optional Tuner Boards	12
AM Frequency Step Setup	12
Installing a Tuner Board	13

Connections

Connecting Antennas	14
Connecting the Indoor FM Antenna	14
Connecting the AM Loop Antenna	14
Connecting the TUN-3.7	16
Connecting to an Amplifier	16
About the System Functions	16
Connecting the 12V Trigger Jacks	17
Controlling Components That Are Out of Range	18

Enjoying Audio Sources

Turning On and Listening to AM and FM Radio	19
Turning On the TUN-3.7	19
Listening to AM and FM Radio	19
Tuning into Stations by Frequency	20
Listening to XM Satellite Radio	21
Listening to XM Satellite Radio® (North American Models Only)	21
Setting the Satellite Radio Mode	22
Selecting XM Satellite Radio	22
Signing Up for XM Satellite Radio	22
Selecting XM Radio Channels	23
Displaying XM Radio Information	24
Positioning the XM antenna	24
Listening to HD Radio™ Stations	25
About HD Radio Stations	25
Selecting Multicast Channels	25
Selecting the Audio Format (Blend Mode)	26
Displaying HD Radio Information	26
Using RDS	26
Displaying RDS Information	26
Using Presets	27
Presetting Your Favorite Stations	27
Selecting Presets	27
Deleting Presets	27
Changing the Remote ID	28

Others

Troubleshooting	29
If you can't resolve an issue, try resetting the AV receiver by holding down the [Memory] button and pressing the [Standby/On] button.	
Specifications	31

Supplied Accessories

Make sure you have the following accessories:

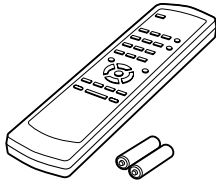

Remote controller and two batteries (AA/R6)

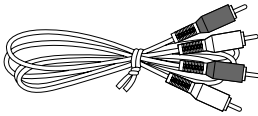

Audio cable (1)

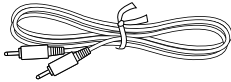

RI cable (1)

To use **RI**, the TUN-3.7 must be connected with an **RI** cable and an audio cable.

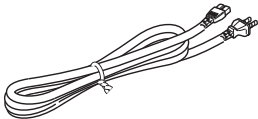

Power cord

(Plug type varies from country to country.)

Before Using the TUN-3.7

Connecting the Supplied Power Cord

Plug the supplied power cord into this AC INLET.

- Do not use a power cord other than the one supplied with this tuner. It's designed exclusively for use with this tuner and should not be used with any other component.
- Never disconnect the power cord from the tuner while the other end is still plugged into a wall outlet. Doing so may cause an electric shock. Always disconnect the power cord from the wall outlet first.

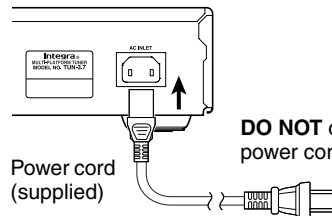

DO NOT connect the power cord at this time.

Power cord (supplied)

* In catalogs and on packaging, the letter added to the end of the product name indicates the color of the TUN-3.7. Specifications and operation are the same regardless of color.

Installing the Batteries

- 1 Open the battery compartment, as shown.

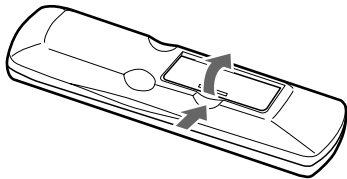

- 2 Insert the two supplied batteries (AA) in accordance with the polarity diagram inside the battery compartment.

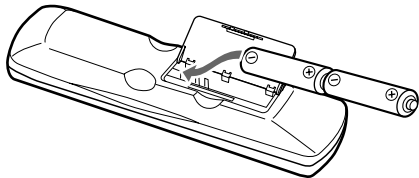

- 3 Close the battery compartment.

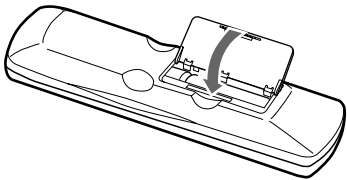

Notes:

- If the remote controller doesn't work reliably, try replacing the batteries.
- Don't mix new and old batteries or different types of batteries.
- If you intend not to use the remote controller for a long time, remove the batteries to prevent damage from leakage and corrosion.
- Flat batteries should be removed as soon as possible to prevent damage from leakage and corrosion.

Aiming the Remote Controller

When using the remote controller, point it toward the TUN-3.7's remote control sensor, as shown below.

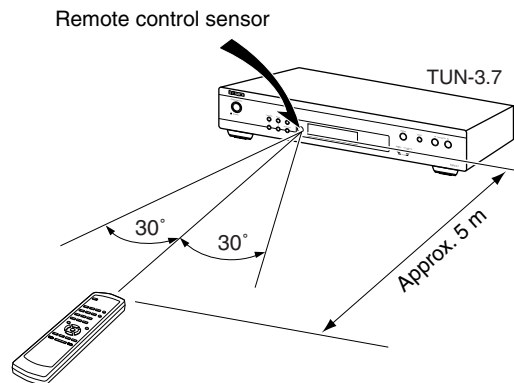

Notes:

- The remote controller may not work reliably if the TUN-3.7 is subjected to bright light, such as direct sunlight or inverter-type fluorescent lights. Keep this in mind when installing.
- If another remote controller of the same type is used in the same room, or the TUN-3.7 is installed close to equipment that uses infrared rays, the remote controller may not work reliably.
- Don't put anything, such as a book, on the remote controller because the buttons may be pressed inadvertently, thereby draining the batteries.
- The remote controller may not work reliably if the TUN-3.7 is installed in a rack behind colored glass doors. Keep this in mind when installing.
- The remote controller will not work if there's an obstacle between it and the TUN-3.7's remote control sensor.

Getting to Know the TUN-3.7

Front Panel

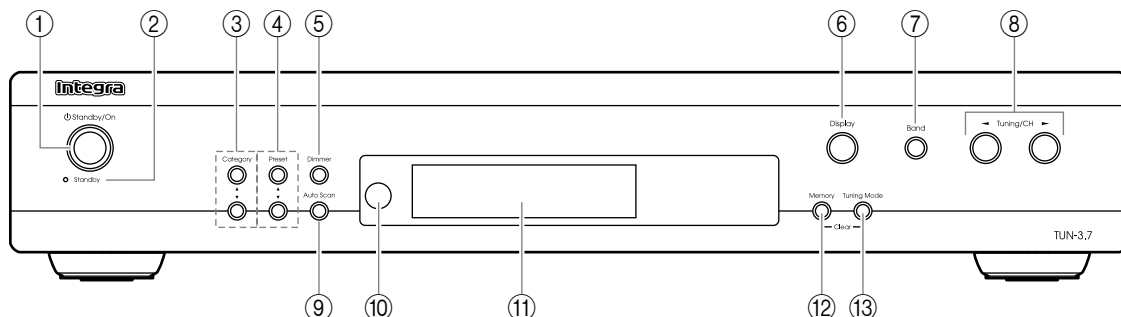

For detailed information, refer to the pages in parentheses.

- ① **Standby/On button (19)**
Sets the TUN-3.7 to On or Standby.
- ② **Standby indicator (19)**
Lights up when the TUN-3.7 is on Standby.
- ③ **Category [▲]/[▼] buttons (23, 26)**
Used to select categories for satellite radio. With HD Radio stations, they're used to select multicast channels.
- ④ **Preset [▲]/[▼] buttons (27)**
Used to select radio presets.
- ⑤ **Dimmer button (9)**
Adjusts the display brightness.
- ⑥ **Display button (24, 26)**
Used to view various information on the display.
- ⑦ **Band button (19, 22)**
Used to select radio bands, AM, FM, and so on. The bands available depends on the type of tuner board installed.
- ⑧ **Tuning/CH [◀]/[▶] buttons (19, 23)**
With AM and FM, these buttons are used for tuning. With XM Radio, they're used to select stations.
- ⑨ **Auto Scan button (26, 27)**
Starts the Auto Scan function, which selects and outputs each radio preset in turn for 5 seconds.
- ⑩ **Remote control sensor (7)**
Receives control signals from the remote controller.
- ⑪ **Display**
See the next page.
- ⑫ **Memory button (27)**
Used to store and delete radio presets.
- ⑬ **Tuning Mode button (19, 23, 27)**
With AM and FM, this button selects the Auto or Manual tuning mode. With XM Radio, it selects the search modes.

* XM Radio/HD Radio reception requires C-HDXM tuner board.

Display

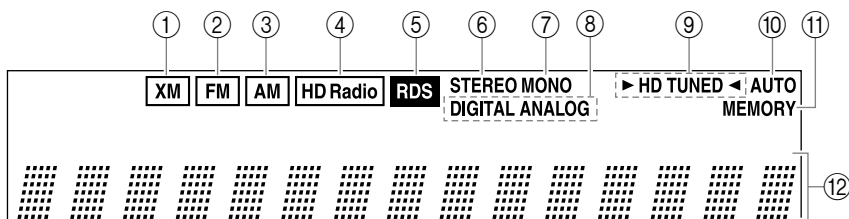

① XM (requires C-HDXM tuner board)

Lights up if the installed tuner board supports XM Satellite Radio. When XM is selected, a box appears around it.

② FM

Lights up if the installed tuner board supports FM. When FM is selected, a box appears around it.

③ AM

Lights up if the installed tuner board supports AM. When AM is selected, a box appears around it.

④ HD Radio

Lights up if the installed tuner board supports HD Radio technology. When the HD Radio band is selected, a box appears around it.

⑤ RDS (requires C-HDXM tuner board)

Lights up when tuned to an FM radio station that supports RDS (Radio Data System).

⑥ STEREO

Lights up when radio reception is in stereo. The indicator does not light up if the installed tuner board supports HD Radio technology.

⑦ MONO

Lights up when radio reception is in mono. The indicator does not light up if the installed tuner board supports HD Radio technology.

⑧ HD Radio indicators

(These indicators function only when a tuner board that supports HD Radio technology, such as a C-HDXM, has been installed.)

DIGITAL: Lights up when a digital HD Radio transmission is being received.

ANALOG: Lights up when an analog HD Radio transmission is being received.

⑨ ► HD TUNED ◀

The ► TUNED ◀ indicator lights up when properly tuned to a radio station. During Auto Tuning, the Tuning Arrows flash. When tuned to an HD Radio station, the indicator appears as ► HD TUNED ◀.

⑩ AUTO

Lights up when Auto Tuning mode is selected.

⑪ MEMORY

Lights up when presetting radio stations.

⑫ Message area

Various information is displayed here, including radio preset numbers, tuning frequency, and so on.

Setting the Display Brightness

With this function, you can adjust the brightness of the display.



Dimmer



Remote controller
Dimmer

Press the [Dimmer] button repeatedly to select: dim, dimmer, or normal brightness.

Alternatively, you can use the [Dimmer] button on the tuner.

Rear Panel

■ C-HDXM tuner board installed

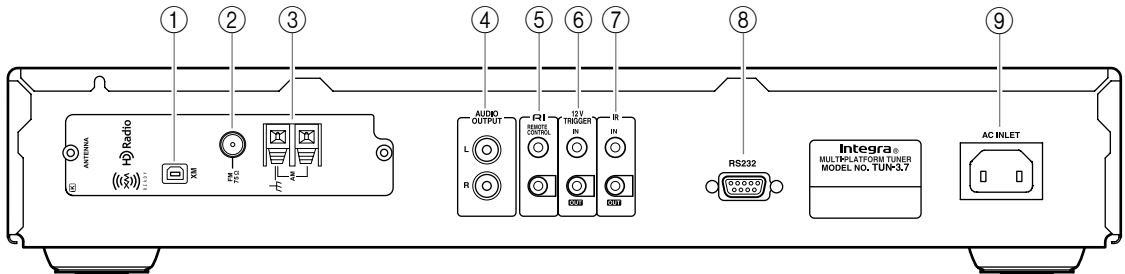

■ C-AMFM tuner board installed

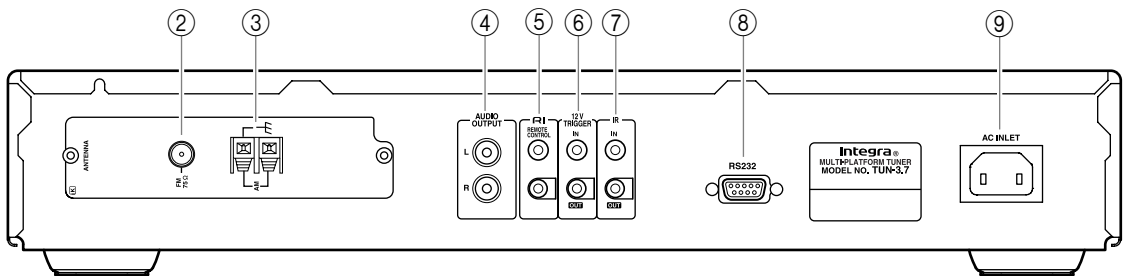

For detailed information, refer to the pages in parentheses.

① XM ANTENNA (C-HDXM tuner board only) (21)

This jack is for connecting the XM Mini-Tuner (not supplied).

② FM 75Ω ANTENNA (14)

This jack is for connecting an indoor or outdoor FM antenna. An indoor FM antenna is supplied with each tuner board.

③ AM ANTENNA (14)

These push terminals are for connecting an AM loop antenna or outdoor AM antenna. An AM loop antenna is supplied with each tuner board.

④ AUDIO OUTPUT (16)

Using the supplied audio cable, connect these output jacks to an analog audio input on your amp.

⑤ RI REMOTE CONTROL (17)

These two identical **RI** (Remote Interactive) jacks can be connected to the **RI** jacks on your other Integra/Onkyo components for interactive control. To use **RI**, the TUN-3.7 must be connected with an **RI** cable and an audio cable.

⑥ 12V TRIGGER IN/OUT (17)

The 12V TRIGGER IN jack can be connected to the 12-volt trigger output on another component, so that when the other component is turned on, the TUN-3.7 turns on as well.

The 12V TRIGGER OUT jack can be connected to the 12-volt trigger input on another component, so that when the TUN-3.7 is turned on, the other component turns on as well.

⑦ IR IN/OUT (18)

A commercially available IR receiver can be connected to the IR IN jack, allowing you to control the TUN-3.7 while you're in another room, or control it when it's out of sight, for example, installed in a cabinet.

A commercially available IR emitter can be connected to the IR OUT jack to pass IR (infrared) remote control signals through to other components.

⑧ RS232

This port is for connecting the TUN-3.7 to home automation equipment and external controllers.

⑨ Power cord (6)

The power cord should be connected to a suitable wall outlet.

See pages 16–18 for connection information.

Remote Controller

Remote Controller

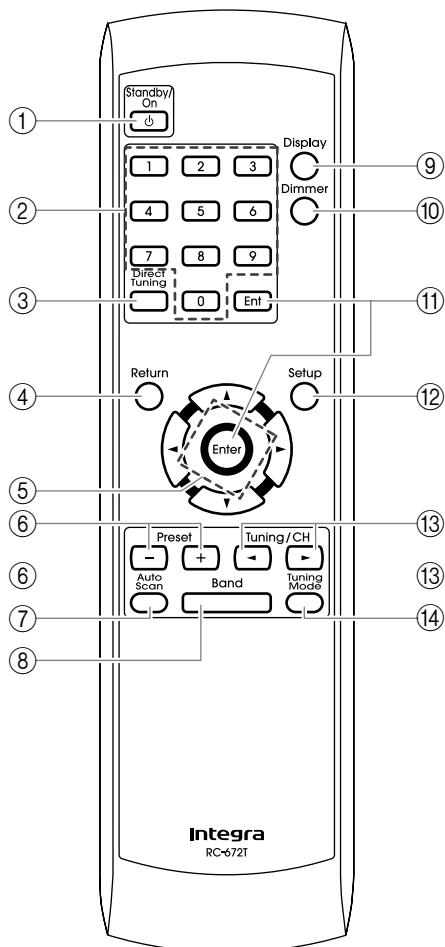

- ① **Standby/On button (19)**
Sets the TUN-3.7 to On or Standby.
- ② **Number buttons (20, 23, 28)**
Used to select radio presets by number, and to enter AM/FM station frequencies and XM Radio channel numbers in Direct Tuning mode.
- ③ **Direct Tuning button (20, 23)**
Selects the Direct Tuning mode. With AM and FM, you can select a station directly by entering its frequency. With XM, you can select a station directly by entering its channel number.
- ④ **Return button (28)**
Returns to the previous display.
- ⑤ **Arrow [▲]/[▼]/[◀]/[▶] buttons (12, 22–25, 28)**
With AM and FM, the Up and Down [▲]/[▼] buttons are used for tuning. With XM Radio, the Up and Down [▲]/[▼] buttons are used to select channels.
The Left and Right [◀]/[▶] buttons are used to select category.
- ⑥ **Preset [+]/[-] buttons (27)**
Used to select radio presets.
- ⑦ **Auto Scan button (26, 27)**
Starts the Auto Scan function, which selects and outputs each radio preset in turn for 5 seconds.
- ⑧ **Band button (19, 22)**
Used to select radio bands, AM, FM, and so on. The bands available depends on the type of tuner board installed.
- ⑨ **Display button (24, 26)**
Used to view various information on the display.
- ⑩ **Dimmer button (9)**
Adjusts the display brightness.
- ⑪ **Ent and Enter buttons (12, 22–25, 28)**
Used to confirm various functions and settings. Also used to select secondary multicast channels with HD Radio stations.
- ⑫ **Setup button (12, 22, 24, 28)**
Selects Setup mode.
- ⑬ **Tuning/CH [◀]/[▶] buttons (19, 23)**
With AM and FM, these buttons are used for tuning. With XM Radio, they're used to select stations.
- ⑭ **Tuning Mode button (19, 23)**
With AM and FM, this button selects the Auto or Manual tuning mode. With XM Radio, it selects the search modes.

* XM Radio/HD Radio reception requires C-HDXM tuner board.

Optional Tuner Boards

The following optional tuner boards are available for the TUN-3.7.

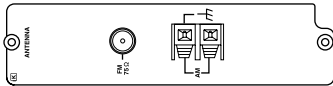
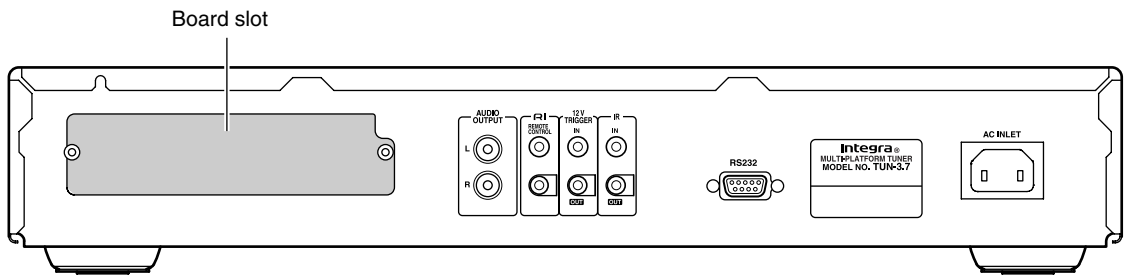

Product number: C-AMFM
AM/FM tuner

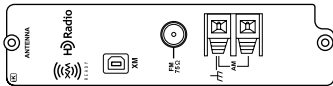

Product number: C-HDXM
HD Radio AM/FM tuner, and XM Satellite Radio tuner

Caution:

- Before installing or removing a board, be sure to turn off the TUN-3.7 and unplug the power cord from the wall outlet. Failure to do so could seriously damage your equipment.

AM Frequency Step Setup

In most cases, you do not need to perform the following procedure. However, if the purchased board is the worldwide model and you plan to use it in North America, you must change the AM Frequency setting to 10 kHz after installing the board.

<p>1 Remote controller Setup</p>	<p>Press the [Setup] button.</p>
<p>2 Remote controller</p>	<p>Use the Up and Down Arrow [▲]/[▼] buttons to select “Hardware Setup,” and then press [Enter].</p> <p>With some tuner boards, there will only be one option available and you won't need to use the Up and Down Arrow [▲]/[▼] buttons.</p>

<p>3 Remote controller</p>	<p>Use the Up and Down Arrow [▲]/[▼] buttons to select “AM Freq.”</p> <p>With some tuner boards, there will only be one option available and you won't need to use the Up and Down Arrow [▲]/[▼] buttons.</p>
<p>4 Remote controller</p>	<p>Use the Left and Right Arrow [◀]/[▶] buttons to select:</p> <p>9 kHz: Select if 9 kHz steps are used in your area.</p> <p>10 kHz: Select if 10 kHz steps are used in your area.</p>
<p>5 Remote controller Setup</p>	<p>Press the [Setup] button.</p>

Installing a Tuner Board

Use the Allen wrench, hexagonal socket head screws, removal thumbscrews, and so on supplied with the tuner board.

- 1 Turn off the TUN-3.7, and then unplug the power cord from the wall outlet.**

- 2 Use the supplied Allen wrench to unscrew the two hexagonal socket head screws that are securing the existing board or blanking plate.**

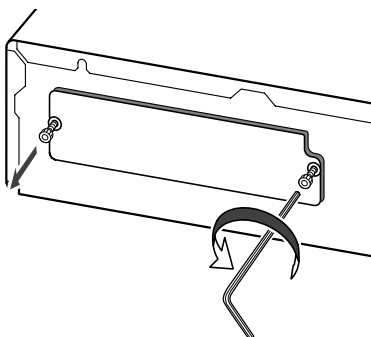

Note:

To remove an existing tuner board, use the following procedure.

Screw the supplied removal thumbscrews into the two holes just below the holes that were used by the hexagonal socket head screws. Screw them in about 3/16" (5 mm). Hold and pull both of the thumbscrews to remove the board.

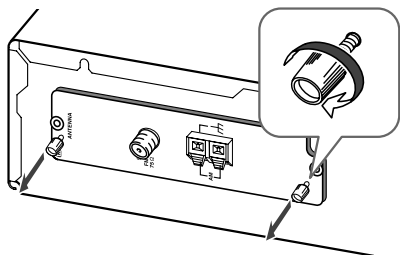

- 3 Carefully remove the board from its bag.**

To prevent electrostatic damage, hold the board by its panel, taking care not to touch any of the components or the underside of the circuit board with your bare hands.

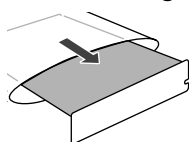

- 4 Insert the board between the guide rails and push it in.**

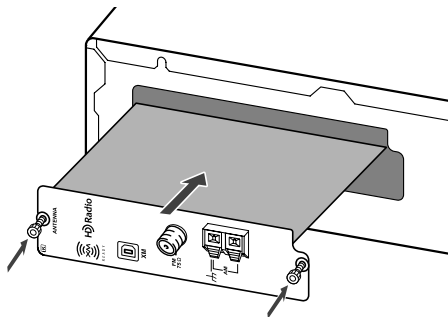

When the board meets the internal connector, apply a little more pressure so that the board plugs fully into the connector. Make sure the board's panel is flush with the TUN-3.7's rear panel.

- 5 Use the Allen wrench to screw tight the two hexagonal socket head screws so that the board is secure.**

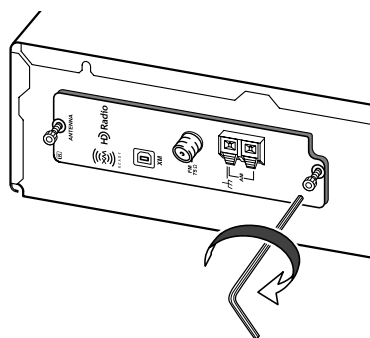

Be sure to fully tighten the screws. If they are loose, the ground connection between the board and the TUN-3.7 may be inadequate, resulting in noise or failure.

Caution:

If any of the screws use washers, be sure to reuse them when installing or removing a board.

Connecting Antennas

This section explains how to connect the indoor FM antenna and AM loop antenna, and how to connect commercially available outdoor FM and AM antennas.

* An indoor FM antenna and AM loop antenna are supplied with each tuner board.

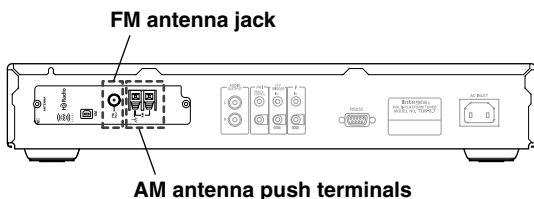

Connecting the Indoor FM Antenna

The indoor FM antenna is for indoor use only.

1 Attach the FM antenna, as shown.

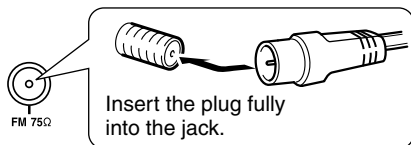

Once the TUN-3.7 is ready for use, you'll need to tune into an FM radio station and adjust the position of the FM antenna to achieve the best possible reception.

2 Use thumbtacks or something similar to fix the FM antenna into position.

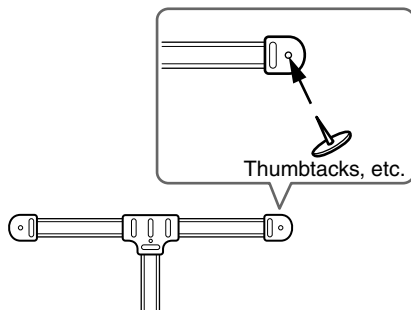

Caution: Be careful that you don't injure yourself when using thumbtacks.

If you cannot achieve good reception with the indoor FM antenna, try using a commercially available outdoor FM antenna instead.

Connecting the AM Loop Antenna

The indoor AM loop antenna is for indoor use only.

1 Assemble the AM loop antenna, inserting the tabs into the base, as shown.

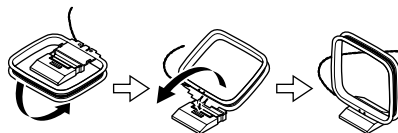

2 Connect both wires of the AM loop antenna to the AM push terminals, as shown.

(The antenna's wires are not polarity sensitive, so they can be connected either way around).

Make sure that the wires are attached securely and that the push terminals are gripping the bare wires, not the insulation.

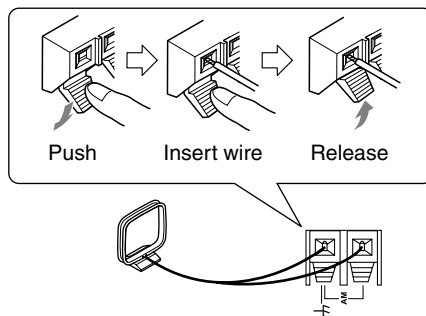

Once the TUN-3.7 is ready for use, you'll need to tune into an AM radio station and adjust the position of the AM antenna to achieve the best possible reception.

Keep the antenna as far away as possible from the TUN-3.7, TV, speaker cables, and power cords.

If you cannot achieve good reception with the indoor AM loop antenna, try using it with a commercially available outdoor AM antenna.

Connecting Antennas—Continued

Connecting an Outdoor FM Antenna

If you cannot achieve good reception with the indoor FM antenna, try a commercially available outdoor FM antenna instead.

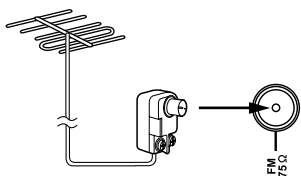

Notes:

- Outdoor FM antennas work best outside, but usable results can sometimes be obtained when installed in an attic or loft.
- For best results, install the outdoor FM antenna well away from tall buildings, preferably with a clear line of sight to your local FM transmitter.
- Outdoor antenna should be located away from possible noise sources, such as neon signs, busy roads, etc.
- For safety reasons, outdoor antenna should be situated well away from power lines and other high-voltage equipment.
- Outdoor antenna must be grounded in accordance with local regulations to prevent electrical shock hazards.

■ Using a TV/FM Antenna Splitter

It's best not to use the same antenna for both FM and TV reception, as this can cause interference problems. If circumstances demand it, use a TV/FM antenna splitter, as shown.

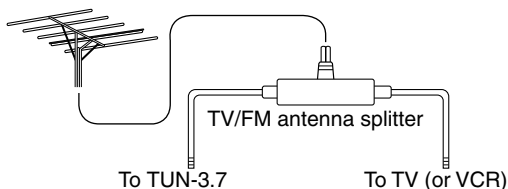

Connecting an Outdoor AM Antenna

If good reception cannot be achieved using the AM loop antenna, an outdoor AM antenna can be used in addition to the loop antenna, as shown.

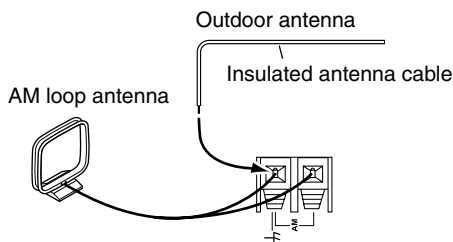

Outdoor AM antennas work best when installed horizontally outside, but good results can sometimes be obtained indoors by mounting horizontally above a window. Note that the AM loop antenna should be left connected.

Outdoor antenna must be grounded in accordance with local regulations to prevent electrical shock hazards.

Connecting the TUN-3.7

Before Making Any Connections

- Refer to the instructions that came with the component you are connecting.
- Do not plug in the power cord until all other connections are complete.
- Do not bind audio cables with power cords and speaker cables. Doing so may adversely affect the sound quality.
- To prevent interference, keep power cords and speaker cables as far away as possible from the antennas.

RCA Audio Connection Color Coding

- Red plugs are used for the right channel, white plugs are used for the left channel.

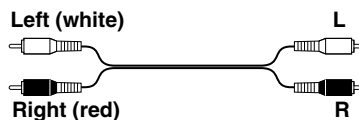

- Push each plug in all the way to make a good connection (loose connections can cause noise or malfunctions).

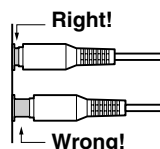

Connecting to an Amplifier

Use the supplied audio cable to connect the TUN-3.7's AUDIO OUTPUT L/R jacks to the TUNER IN jacks on your amplifier, as shown.

To use the **RI** system functions, use the supplied **RI** cable to make an **RI** connection (see the next column).

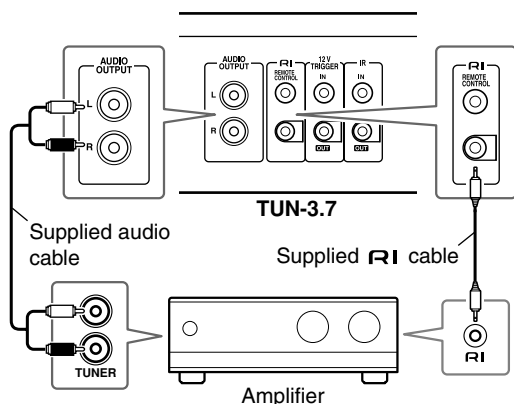

Note:

- If the TUN-3.7 is used with another Integra/Onkyo component, refer to its instruction manual as well.

About the System Functions

If you connect the TUN-3.7 to another Integra/Onkyo **RI**-capable component with the supplied **RI** cable and audio cable, you can use the following system functions. **RI** cables are special cables solely for use with Integra/Onkyo products.

Auto Power On

When you turn on the TUN-3.7, your Integra/Onkyo amplifier or receiver will turn on automatically. (The amplifier's POWER switch must be set to ON for this to work.)

Direct Change

When you select a radio preset or change the band (AM, FM, etc.), your Integra/Onkyo amplifier will automatically select the TUN-3.7 as the input source.

Remote Control Operation

You can control the TUN-3.7 by using your Integra/Onkyo amplifier or receiver's remote controller. See the amplifier or receiver's instruction manual for details.

Connecting the TUN-3.7—Continued

With **RI** (Remote Interactive), you can control your **RI**-capable Integra/Onkyo CD player, TUN-3.7, and so on with your amp's remote controller.

- To use **RI**, you must make an analog audio connection between your amplifier and each audio component.

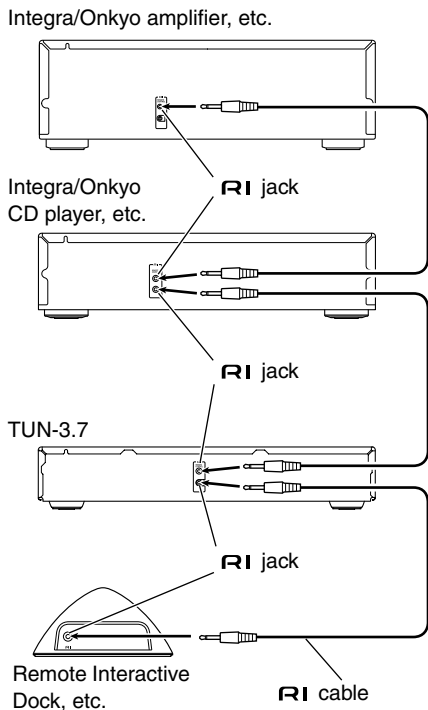

Notes:

- Push each plug in all the way to make a good connection.
- Use only dedicated **RI** cables for **RI** connections. **RI** cables are supplied with Integra/Onkyo tuners and players (DVD, CD, etc.).
- Some components, including the TUN-3.7, have two **RI** jacks. They're both the same, so use either one.
- **RI** jacks should be connected only to Integra/Onkyo components. Connecting them to another manufacturer's component may cause a malfunction.
- Some components may not support all **RI** functions. See the manuals supplied with your other Integra/Onkyo components for more information.

Connecting the 12V Trigger Jacks

To have the TUN-3.7 turn on automatically when another component is turned on, connect the TUN-3.7's 12V TRIGGER IN jack to a 12-volt trigger output on the other component with a miniplug cable.

Likewise, to have another component turn on automatically when the TUN-3.7 is turned on, connect the TUN-3.7's 12V TRIGGER OUT jack to a 12-volt trigger input on the other component with a miniplug cable.

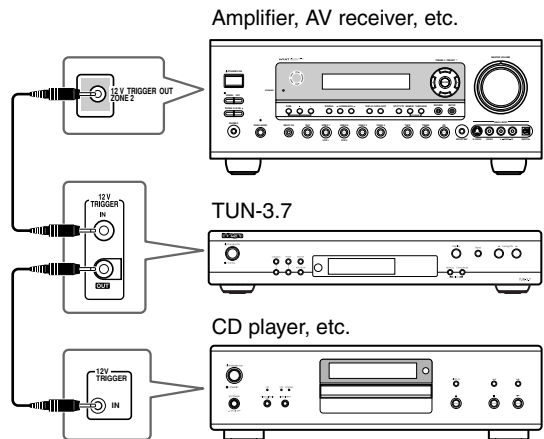

Controlling Components That Are Out of Range

You can use the following multi-room kits to control the TUN-3.7 when it's out of range of the remote controller:

- Multiroom AV distribution and control systems such as those made by Niles® and Xantech®.

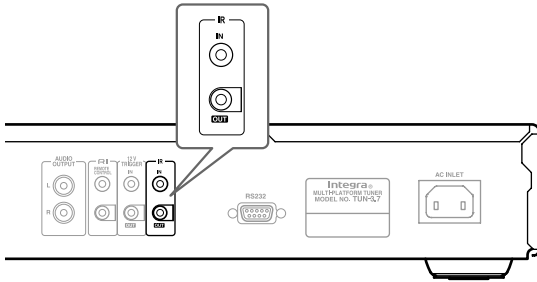

Controlling the TUN-3.7 When It's Out of Range

If the TUN-3.7 is located in another room, installed in a cabinet, or out of range of its remote controller, you can use a commercially available IR receiver to pick up the remote controller signals and feed them to the TUN-3.7, as shown below.

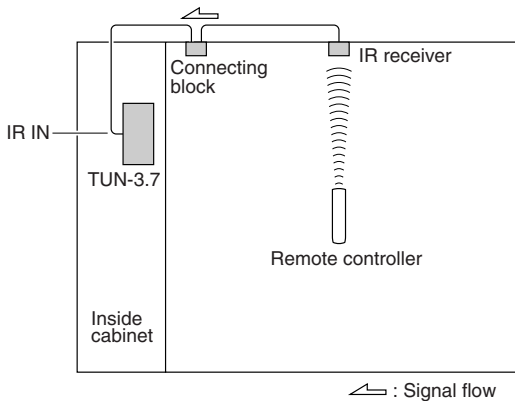

Connect the IR receiver to the TUN-3.7 as shown below.

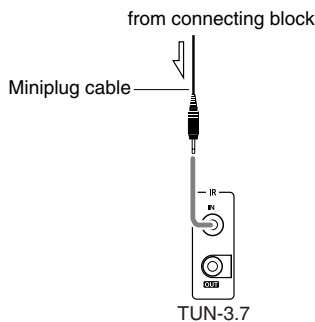

Controlling Other Out-of-range Components

If another component is out of range of its remote controller, you can use a commercially available IR emitter to retransmit the remote controller signals received at the TUN-3.7's IR IN, as shown below.

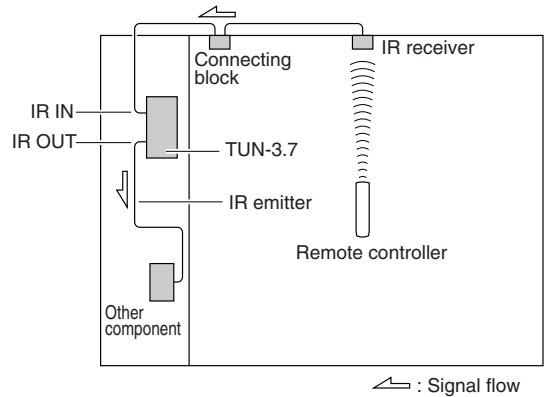

Connect the IR emitter to the TUN-3.7's IR OUT, and place the IR emitter in front of the other component's remote control sensor (usually located on its front panel), as shown below. See the instructions supplied with the IR emitter.

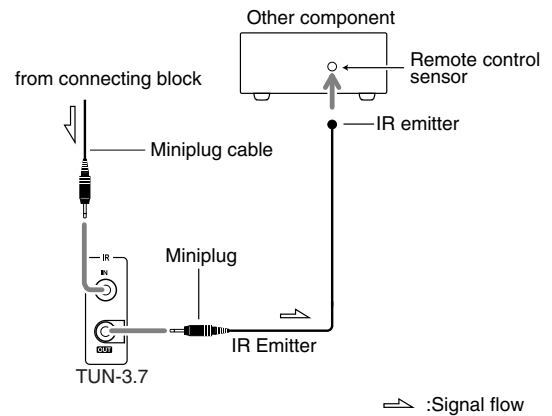

Only remote controller signals received by the TUN-3.7's IR IN are fed through to the IR OUT. Signals picked up by the TUN-3.7's remote control sensor are not output.

Turning On and Listening to AM and FM Radio

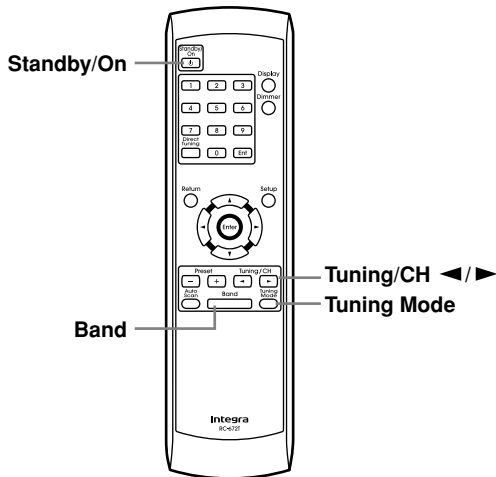
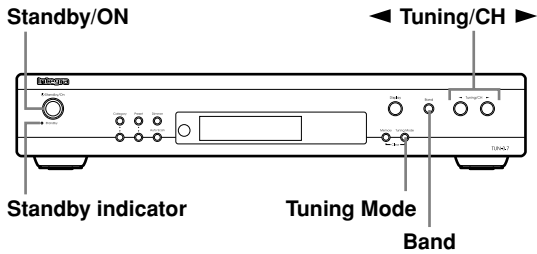

Turning On the TUN-3.7

- 1** Connect the power cord to a suitable wall outlet.
- 2** Press the [Standby/On] button on the TUN-3.7 or remote controller.
 The TUN-3.7 turns on, and the Standby indicator goes off.

To turn off the TUN-3.7, press the [Standby/On] button. The TUN-3.7 will enter Standby mode.
 Note that the TUN-3.7 is not completely shutdown in Standby mode.

Listening to AM and FM Radio

- 1** Press the [Band] button repeatedly to select AM or FM.
 The [AM] or [FM] indicator lights up.

Remote controller: Band
- 2** Press the [Tuning Mode] button repeatedly to select Auto or Manual Tuning mode.

 - Auto Tuning Mode**
 The AUTO indicator appears and stereo radio reception is possible.
 - Manual Tuning Mode**
 The MONO indicator appears and radio reception will be in mono.

MONO indicator AUTO indicator

Remote controller: Tuning Mode

Note:
 The MONO indicator does not light up if the installed tuner board supports HD Radio technology.

- Auto Tuning Mode**
 The AUTO indicator appears.
- Manual Tuning Mode**
 AUTO indicator disappears.

- 3** Use the Tuning/CH [◀]/[▶] buttons to tune into a station.

In Auto Tuning mode, once a station is found, tuning stops automatically. The American model changes FM frequency in 0.2 MHz steps, 10 kHz steps for AM.

For other models, it's 0.05 MHz steps for FM and 9 kHz or 10 kHz steps for AM.

In Manual Tuning mode, the frequency stops changing when you release the buttons. Press the buttons repeatedly to change the frequency one step at a time.

Remote controller: Tuning/CH

Turning On and Listening to AM and FM Radio—Continued

When tuned into a station, the ► TUNED ◀ indicator appears.

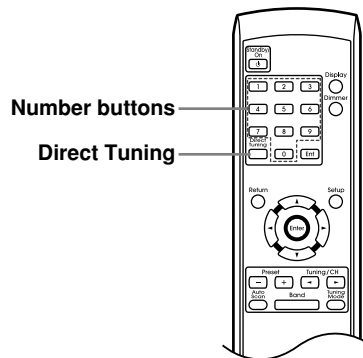
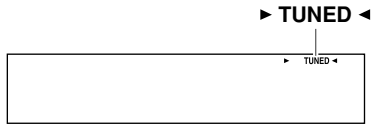

Tuning into weak stereo FM stations

If the signal from a stereo FM station is weak, it may be impossible to get good reception. In this case, switch to Manual Tuning mode and listen to the station in mono.

Tuning into Stations by Frequency

You can tune into AM and FM stations directly by entering the appropriate frequency.

1

Press the [Direct Tuning] button.

Remote controller

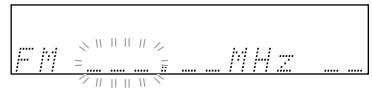

(Actual display depends on country.)

2

Within 8 seconds, use the number buttons to enter the frequency of the radio station.

Remote controller

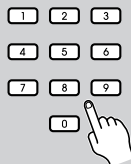

For example, to tune into an FM station at 87.5 MHz, press [8], [7], and [5].

Adjusting the Antennas

Adjusting and installing the FM antenna

Choose a location for the FM antenna while listening to an FM station.

1

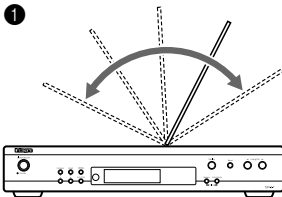

Change the direction of the antenna to achieve the best possible reception.

2

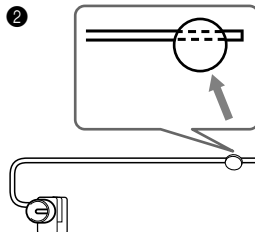

Affix the antenna with a thumbtack. (Do not push the thumbtack through the antenna.)

Caution: Be careful not to prick your finger!

Adjusting the AM antenna

Adjust the location and position of the AM antenna while listening to an AM station to achieve the best possible reception.

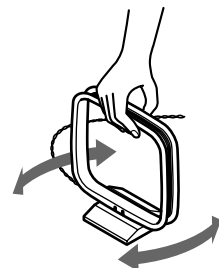

Listening to XM Satellite Radio

Listening to XM Satellite Radio® (North American Models Only)

Important XM Radio Information

XM Satellite Radio offers an extraordinary variety of commercial-free music, plus the best in sports, news, talk and entertainment. XM is broadcast in superior digital audio from coast to coast. From rock to reggae, from classical to hip hop, XM has something for every music fan. XM's dedication to playing the richest selection of music is matched by its passion for live sporting events, talk radio, up-to-the-minute news, stand-up comedy, children's programming, and much more. For U.S. customers, information about XM Satellite Radio is available online at www.xmradio.com. For Canadian customers, information about XM Canada is online at www.xmradio.ca.

Note:

Hardware and required monthly subscription sold separately. Other fees and taxes, including a one-time activation fee may apply. Subscription fee is consumer only. All fees and programming subject to change. Channels with frequent explicit language are indicated with an XL. Channel blocking is available for XM radio receivers by calling 1-800-XMRADIO (US residents) and 1-877-GET-XMSR (Canadian residents).

For a full listing of the XM commercial-free channels and advertising-supported channels, visit lineup.xmradio.com (US residents) or xmradio.ca (Canadian residents).

Subscriptions subject to Customer Agreement available at xmradio.com (US residents) and xmradio.ca (Canadian residents). Only available in the 48 contiguous United States and Canada. ©2006 XM Satellite Radio Inc. All rights reserved. All other trademarks are the property of their respective owners

A warning against reverse engineering:

It is prohibited to copy, decompile, disassemble, reverse engineer, or manipulate any technology incorporated in receivers compatible with the XM Satellite Radio system. Furthermore, the AMBE® voice compression software included in this product is protected by intellectual property rights including patent rights, copyrights, and trade secrets of Digital Voice Systems, Inc. The user of this or any other software contained in an XM Radio is explicitly prohibited from attempting to copy, decompile, reverse engineer, or disassemble the object code, or in any other way convert the object code into human-readable form. The software is licensed solely for use within this product.

Connecting the XM Mini-Tuner and Home Dock

To receive XM Satellite Radio, you need an XM Mini-Tuner and Home Dock, which includes a home antenna. These are sold separately. For connection information, refer to the instruction manual supplied with the XM Mini-Tuner and Home Dock.

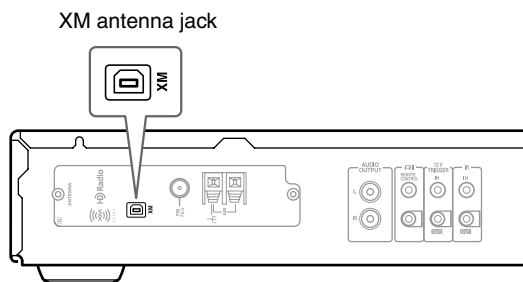

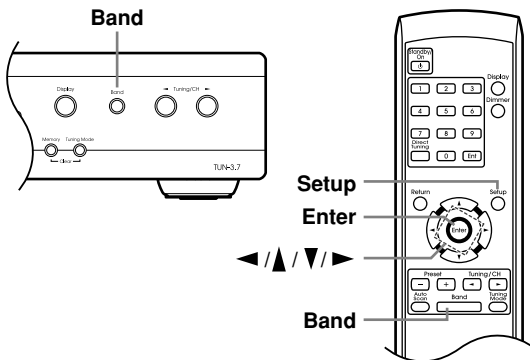

Selecting XM Satellite Radio

1 **Band**
 Press the [Band] button repeatedly to select XM.
 If “CHECK ANTENNA” appears on the display, make sure the XM Mini-Tuner is connected properly.

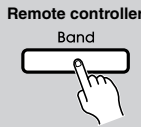

Setting the Satellite Radio Mode

1 **Remote controller**
 Press the [Setup] button.



2 **Remote controller**
 Use the Up and Down Arrow [▲]/[▼] buttons to select “SAT Radio Mode,” and then press [Enter].

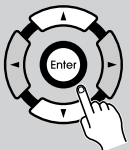

3 **Remote controller**
 Use the Left and Right Arrow [◀]/[▶] buttons to select “XM.”
 The choices available depends on the type of tuner board you’re using.
 If you’ve not using satellite radio, select None.

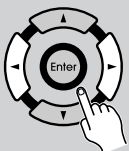

4 **Remote controller**
 Press the [Setup] button.



Signing Up for XM Satellite Radio

Once you have installed the XM Mini-Tuner and Home Dock, you are ready to subscribe to XM Satellite Radio. You’ll need a major credit card and your XM Radio ID. There are three places you can find your 8-character XM Radio ID:

1. On the XM Mini-Tuner
2. On the XM Mini-Tuner packaging
3. On XM Channel 0, as explained below

1 **Remote controller**
 Use the Up and Down Arrow [▲]/[▼] buttons to select “RADIO ID.”

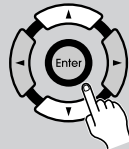

Alternatively, press the [Direct Tuning] button, followed within 8 seconds by the [0] button and [Enter] button.
 Your XM Satellite Radio ID number is displayed. Write it below.

ID:

2
 To sign up, go to:
<http://activate.xmradio.com>
 Or call: 1-800-XM-RADIO
 (1-800-967-2346)
 For XM Canada, go to:
<http://xmradio.ca>
 Or call: 1-877-GET-XMSR
 (1-877-438-9677)

Notes:

- RADIO ID cannot be selected in Category Search mode. You must select Channel Search mode (see page 23).
- The following letters are not used in XM Satellite Radio IDs: I, O, S, F.
- XM Satellite Radio will transmit a special signal to the TUN-3.7 to activate the full channel lineup. Activation normally takes between 10 and 15 minutes, but during busy peak periods, you may need to leave the TUN-3.7 turned on for up to an hour.

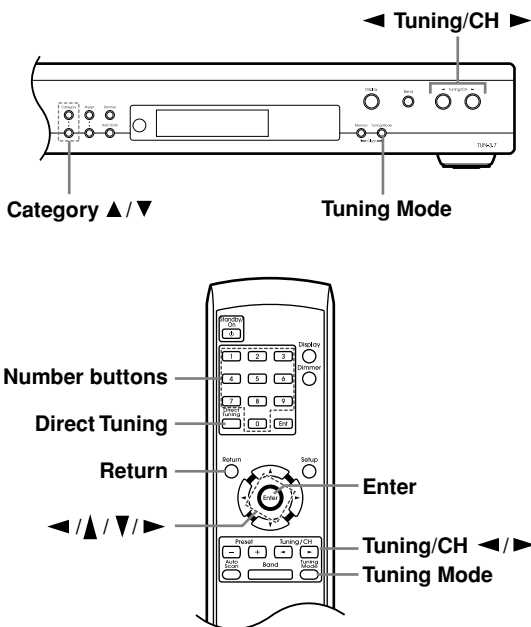

Selecting XM Radio Channels

There are three ways to select XM Radio channels:

- **Channel Search mode:** select any channel.
- **Category Search mode:** select channels by category.
- **Direct tuning:** enter channel number.

Channel Search Mode

<p>1 Tuning Mode</p> <p>Remote controller</p>	<p>Press the [Tuning Mode] button to select Channel Search mode.</p>
<p>2</p> <p>Remote controller</p>	<p>Use the TUN-3.7's Tuning/CH [◀]/[▶] button, or remote controller's Up and Down Arrow [▲]/[▼] buttons to select a channel.</p> <p>You can also use the remote controller's Left and Right Arrow [◀]/[▶] buttons to select a category.</p>

Category Search Mode

<p>1 Tuning Mode</p> <p>Remote controller</p>	<p>Press the [Tuning Mode] button to select Category Search mode.</p>
<p>2 Category</p> <p>Remote controller</p>	<p>Use the TUN-3.7's [Category] [▲]/[▼] buttons, or remote controller's Left and Right [◀]/[▶] buttons to select a category, and use the TUN-3.7's Tuning/CH [◀]/[▶] button, or remote controller's Up and Down Arrow [▲]/[▼] buttons to select a channel in that category.</p>

Direct Tuning

You can select an XM Radio channel directly by entering its number with the remote controller.

<p>1</p> <p>Remote controller</p>	<p>Press the [Direct Tuning] button.</p>
<p>2</p> <p>Remote controller</p> <p>Enter</p>	<p>Within 8 seconds, use the number buttons to enter the channel number.</p> <p>For example, to select channel #20, press [0], [2], and [0], or press [2], [0], and [Enter].</p>

Selecting the Previous Channel

To listen to the previously selected XM channel, press the [Return] button.

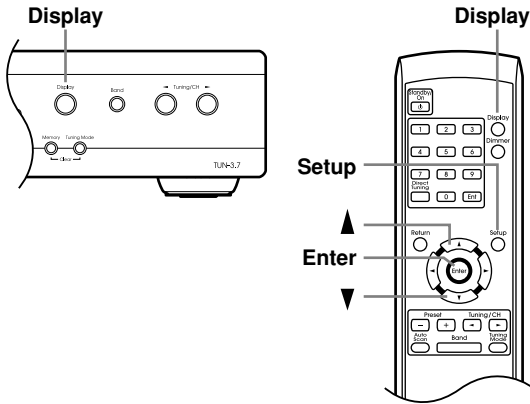

Displaying XM Radio Information

Press the [Display] button repeatedly to cycle through the available information.

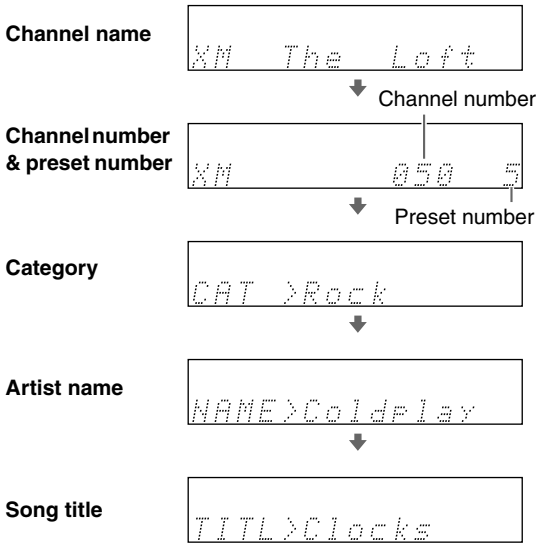

Note:
If the category, artist, or song title is not available, “- - -” will be displayed instead.

■ XM Radio Messages

The following messages may appear while using XM Radio.

CHECK ANTENNA

The XM Mini-Tuner and/or antenna is not connected properly. Check the connection.

UPDATING

The XM user encryption code is being updated. Please wait.

NO SIGNAL

The signal is too weak. Check the XM Mini-Tuner and/or antenna connection and reposition it for the best reception.

LOADING

The TUN-3.7 is tuning or decoding audio or text data. Please wait.

OFF AIR

The XM channel you selected is not currently broadcasting. Select another channel.

Positioning the XM antenna

You can check the signal strength of the XM Radio signal and adjust the position of the XM antenna accordingly.

<p>1</p> <p>Remote controller</p>	<p>Press the [Setup] button.</p>
<p>2</p> <p>Remote controller</p>	<p>Use the Up and Down Arrow [▲]/[▼] buttons to select “Antenna Aiming,” and then press [Enter].</p> <div style="border: 1px solid black; padding: 5px; width: fit-content; margin: 10px auto;">2 ANT Aiming</div>
<p>3</p>	<p>Adjust the position of the XM antenna so that the satellite (SAT) signal strength bar is as long as possible.</p> <div style="border: 1px solid black; padding: 5px; width: fit-content; margin: 10px auto;">SAT: []</div> <p>If you can't receive the satellite (SAT) signal, adjust your XM antenna so that the terrestrial (TER) signal strength bar is as long as possible.</p> <p>Press the Down Arrow [▼] button to display the terrestrial (TER) signal bar. Terrestrial signals are only available in certain areas.</p> <div style="border: 1px solid black; padding: 5px; width: fit-content; margin: 10px auto;">TER: []</div> <p>So long as the signal strength is good, you can enjoy XM Radio by using either satellite or terrestrial reception.</p>

Listening to HD Radio™ Stations

HD Radio technology brings digital radio to conventional analog AM and FM radio stations, with improved sound quality, better reception, and new data services. HD Radio technology provides CD-quality sound for FM stations, and FM-quality sound for AM stations. In addition, FM HD Radio stations can transmit multiple programs on the same frequency by using multicast channels. Text data display includes station name, song title, artist name, and so on.

For more information about HD Radio technology, visit:

www.ibiquity.com
www.hdradio.com

About HD Radio Stations

HD Radio stations broadcast on the same AM and FM frequencies they've always used, and you can receive them by tuning into your favorite station as normal (see pages 19, 20). If the current AM or FM station supports HD Radio technology, the HD Radio indicator lights up. When an HD Radio transmission is received, a box appears around the HD Radio indicator, and "HD" appears in the right corner of the message area.

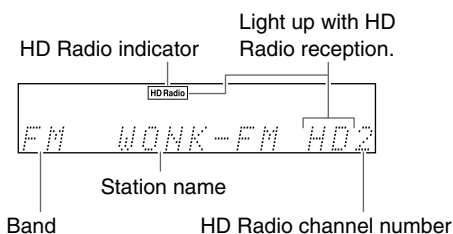

- If the current AM or FM station supports HD Radio technology, the station's name will be displayed instead of the band and frequency.
- When music data is received, song title and artist name information will be displayed next to the HD indicator.
- If the current HD Radio station supports multicast channels, the currently selected multicast channel will be displayed to the right of the HD indicator.

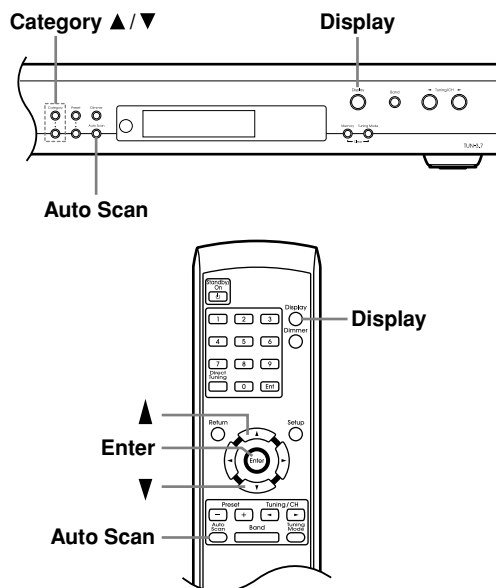

Selecting Multicast Channels

FM HD Radio stations can transmit multiple programs on the same frequency by using what are called *multicast channels*.

■ Using the remote controller:

1

Remote controller

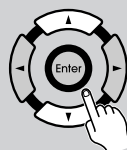

Use the Up and Down Arrow [▲]/[▼] buttons to select a multicast channel.

If you select a multicast channel that is not currently broadcasting, a plus [+] symbol will appear next to the HD indicator, indicating that the channel has been reserved. When broadcasting commences, that channel will be selected automatically.

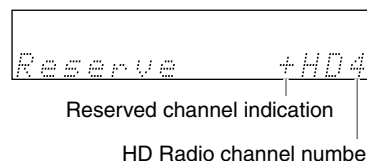

Note:
 Multicast channels are not available on AM.

Listening to HD Radio™ Stations— Continued

■ Using the TUN-3.7:

1 Category



Press the [Category] [▲]/[▼] buttons.

Selecting the Audio Format (Blend Mode)

HD Radio stations transmit both analog and digital versions of their programs and you can choose which one you want to listen to.

Auto Scan



Use the [Auto Scan] button to select Auto or Analog.

Remote controller

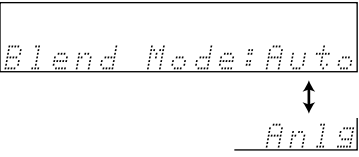
Auto: Select to use the digital signal when available.

Anlg (Analog): Select to use the analog signal.

Note:

- Multicast channels 2 through 8 only carry a digital signal, so to select an audio format, you must select multicast channel #1 first.

Displaying HD Radio Information

Press the [Display] button repeatedly to cycle through the available information.

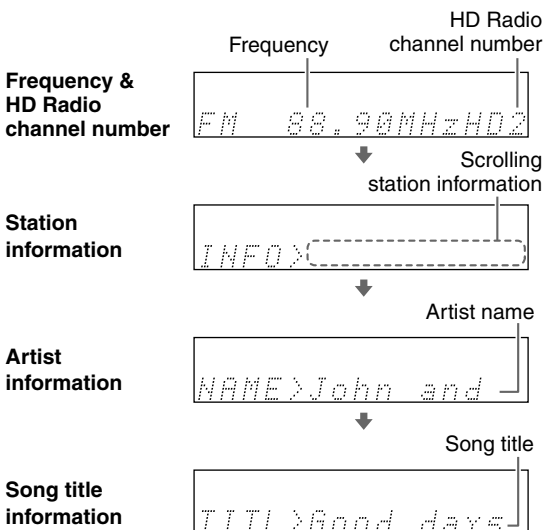

Frequency & HD Radio channel number

Frequency HD Radio channel number

FM 88.90MHz HD2

↓ Scrolling station information

Station information

INFO>

↓ Artist name

Artist information

NAME>John and

↓ Song title

Song title information

TITL>Good days

Using RDS

RDS stands for *Radio Data System* and is a method of transmitting data in FM radio signals. RDS is approved by the National Radio Systems Committee (NRSC) and is available in North America.

Many FM stations use it these days. In addition to displaying text information, RDS can also help you find radio stations by type (e.g., news, sport, rock, etc.).

This product supports the following types of RDS information: Program Service Name (PS), Radio Text (RT), and Program Type (PTY).

Displaying RDS Information

The RDS indicator lights up when tuned to an FM radio station that supports RDS.

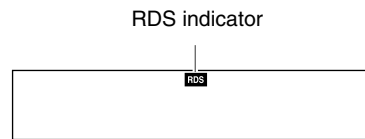

Press the [Display] button repeatedly to cycle through the available information.

1. Program Service Name

When tuned to an RDS station that's broadcasting PS information, the station's name will be displayed.

2. Radio Text

When tuned to an RDS station that's broadcasting RT text information, the text will be shown on the display.

3. Program Type

When tuned to an RDS station that's broadcasting PTY information, the type of program will be displayed.

Note:

If the signal from an RDS station is weak, RDS data may be displayed intermittently or not at all.

Using Presets

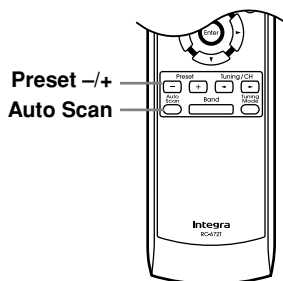
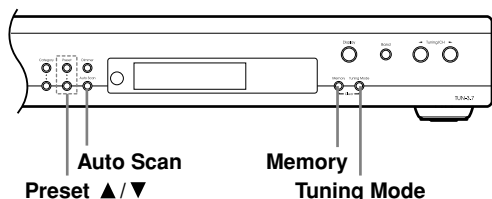

Presetting Your Favorite Stations

You can store any combination of up to 40 of your favorite AM, FM, and XM Satellite radio stations as presets.

■ Using the TUN-3.7:

- 1** Tune into the station that you want to store as a preset.
- 2** Press the [Memory] button. The MEMORY indicator appears and the preset number flashes.
- 3** While the MEMORY indicator is displayed (about 8 seconds), use the Preset [▲]/[▼] buttons to select a preset from 1 through 40.
- 4** Press the [Memory] button again to store the station or channel. The station or channel is stored and the preset number stops flashing. Repeat this procedure for all of your favorite radio stations.

Selecting Presets

■ Using the Preset buttons:

	<p>To select a preset, use the TUN-3.7's Preset [▲]/[▼] buttons, or the remote controller's Preset [+]/[-] buttons.</p>
<p>Remote controller</p>	

■ Using the Auto Scan function:

	<p>Press the [Auto Scan] button. The Auto Scan function automatically selects and outputs each radio preset in turn for 5 seconds.</p>
<p>Remote controller</p>	<p>When you hear the station that you want to listen to, press the [Auto Scan] button again to stop auto scanning.</p>

Deleting Presets

■ Using the TUN-3.7:



- 1** Select the preset that you want to delete. See the previous section.
- 2** While holding down the [Memory] button, press the [Tuning Mode] button. The preset is deleted and its number disappears from the display.

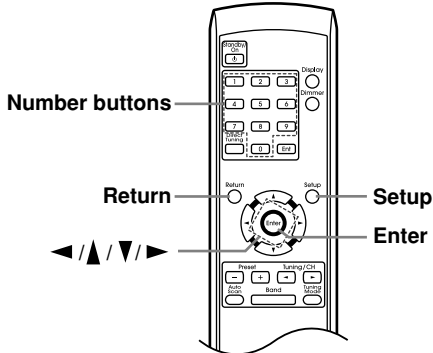

Changing the Remote ID

If the TUN-3.7's remote controller interferes with other Integra/Onkyo components located in the same room, you can change the remote control ID. You can select remote control ID #1, #2, or #3. By default, the remote control ID is set to #1. If you change the ID, you must also change the ID on the remote controller to match, as explained below, otherwise, the remote controller won't work.

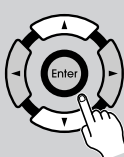



Changing the TUN-3.7's Remote ID

<p>1 Remote controller</p> 	<p>Press the [Setup] button.</p>
<p>2 Remote controller</p>  	<p>Use the Up and Down Arrow [▲]/[▼] buttons to select "Hardware Setup," and then press [Enter].</p> <p>With some tuner boards, there will only be one option available and you won't need to use the Up and Down Arrow [▲]/[▼] buttons.</p>
<p>3 Remote controller</p> 	<p>Use the Up and Down Arrow [▲]/[▼] buttons to select "Remote ID."</p> <p>With some tuner boards, there will only be one option available and you won't need to use the Up and Down Arrow [▲]/[▼] buttons.</p>

<p>4 Remote controller</p> 	<p>Use the Left and Right Arrow [◀]/[▶] buttons to change the remote ID.</p> <p>You can select ID #1 (default), #2, or #3.</p>
<p>5 Remote controller</p> 	<p>Press the [Setup] button.</p> <p>Once you've changed the TUN-3.7's remote ID, the remote controller will no longer control the TUN-3.7, so you must change the remote controller's ID to match, as explained below.</p>

Changing the Remote Controller's ID

<p>1</p>	<p>Before changing the remote controller's ID, change the TUN-3.7's ID first (see above).</p>
<p>2 Remote controller</p> 	<p>Press the remote controller's [Return] button.</p>
<p>3 Remote controller</p>  	<p>While pressing and holding down the remote controller's [Return] button, press number button [1], [2], or [3] for 3 seconds to select ID #1, #2, or #3 respectively.</p>
<p>4</p>	<p>Check whether the remote controller operates the TUN-3.7 properly.</p>

Note:

- The remote controller and TUN-3.7 must be set to the same remote control ID. Otherwise, you won't be able to control the TUN-3.7 with the remote controller.

Troubleshooting

If you have any trouble using the TUN-3.7, look for a solution in this section.

If you can't resolve the issue yourself, try resetting the TUN-3.7 before contacting your Integra/Onkyo dealer.

To reset the TUN-3.7 to its factory defaults, turn it on and, while holding down the [Memory] button, press the [Standby/On] button. "Clear" will appear on the display and the TUN-3.7 will enter Standby mode.

Note that resetting the TUN-3.7 will delete your radio presets and custom settings.

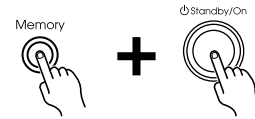

Power

Can't turn on the TUN-3.7.

- Make sure that the power cord is properly plugged into the wall outlet (see page 19). And also, make sure that the other end of the power cord is properly connected to the TUN-3.7's AC INLET (see page 6).
- Unplug the power cord from the wall outlet, wait 5 seconds or more, then plug it in again.

Audio

There's no sound.

- Make sure your amplifier's volume control is not set to minimum.
- Check all connections and correct as necessary (see pages 14 to 18).

Tuner

Reception is noisy, stereo FM reception suffers from hiss, or the STEREO indicator doesn't light up when tuned to a stereo FM station.

- Check the antenna connections (see page 14).
- Change the position of the antenna (see page 20).
- Move the TUN-3.7 away from a nearby TV or computer.
- Cars or airplanes can cause noisy interference.
- The radio signal will be weakened if it has to pass through a concrete wall before reaching the antenna.
- Try selecting Manual Tuning mode (see page 19).
- Move power cords and speaker cables as far away as possible from the antenna.
- When listening to an AM station, noise may be heard when you operate the remote controller.
- If none of the above improves the reception, install an outdoor antenna (see page 15).

If a power outage occurs or the power cable is disconnected:

- If the preset stations are lost, preset them again (see page 27).

Can't adjust the frequency of the radio.

- Use the Tuning/CH [◀]/[▶] buttons to change the frequency of the radio (see page 19).

RDS doesn't work.

- Your Tuner board doesn't support HD Radio reception.
- The FM station you are tuned to doesn't support RDS.
- Install an outdoor FM antenna (see page 15).
- Change the position or direction of your outdoor FM antenna (see page 15).
- Move the FM antenna as far away as possible from fluorescent lights (see page 15).

Remote Controller

The remote controller doesn't work properly.

- Make sure the batteries have been installed with the correct polarity (+/–) (see page 7).
- Replace both batteries with new ones. (Do not mix different types of batteries or new and old batteries.)
- The remote controller is too far away from the TUN-3.7, or there's an obstacle between them (see page 7).
- The TUN-3.7's remote control sensor is being subjected to bright light (inverter-type fluorescent light or sunlight).
- The TUN-3.7 is located behind the glass doors of a audio rack or cabinet.
- The TUN-3.7 and remote controller may be set to different remote control IDs. Set the TUN-3.7's remote control ID first, and then set the remote controller to the same ID (see page 28).

Others

Interactive control with other Integra/Onkyo **RI**-capable components is not working.

- Make sure the **RI** cables and analog audio cables are connected correctly (see page 16). Connecting only an **RI** cable won't work.

The TUN-3.7 contains a microcomputer for signal processing and control functions. In very rare situations, severe interference, noise from an external source, or static electricity may cause it to lock up. In the unlikely event that this should happen, unplug the power cord, wait at least 5 seconds, and then plug it again.

Specifications

General	
Power Supply:	AC 120 V, 60 Hz
Power Consumption:	27 W (when C-HDXM board is used)
Stand-by Power Consumption:	0.2 W
Dimensions (W × H × D):	435 × 81 × 306 mm (17-1/8" × 3-3/16" × 12-1/16") (not include a board)
Weight:	4.5 kg (9.9 lbs.) (not include a board)

FM	
Tuning frequency range:	87.5–107.9 MHz
Usable sensitivity:	Stereo: 22.2 dBf (IHF) Mono: 15.2 dBf (IHF)
Signal-to-noise ratio:	Stereo: 67 dB (IHF-A) Mono: 73 dB (IHF-A)
THD (total harmonic distortion):	Stereo: 0.5% (1 kHz) Mono: 0.3% (1 kHz)
Stereo separation:	40 dB (1 kHz)

AM	
Tuning frequency range:	530–1710 kHz
Usable sensitivity:	300 µV
Signal-to-noise ratio:	40 dB
THD (total harmonic distortion):	0.7%

Specifications and features are subject to change without notice.

Integra Division of
ONKYO U.S.A. CORPORATION
18 park Way, Upper Saddle River, N.J. 07458, U.S.A.
Tel: 201-785-2600 Fax: 201-785-2650 <http://www.integrahometheater.com>

Integra Division of
ONKYO CORPORATION
Sales & Product Planning Div.: 2-1, Nisshin-cho, Neyagawa-shi, OSAKA 572-8540, JAPAN
Tel: 072-831-8023 Fax: 072-831-8124



I0803-2

SN 29344350A

(C) Copyright 2008 ONKYO CORPORATION Japan. All rights reserved.



Download from [Www.Somanuals.com](http://www.Somanuals.com). All Manuals Search And Download. * 2 9 3 4 4 3 5 0 A *

Free Manuals Download Website

<http://myh66.com>

<http://usermanuals.us>

<http://www.somanuals.com>

<http://www.4manuals.cc>

<http://www.manual-lib.com>

<http://www.404manual.com>

<http://www.luxmanual.com>

<http://aubethermostatmanual.com>

Golf course search by state

<http://golfingnear.com>

Email search by domain

<http://emailbydomain.com>

Auto manuals search

<http://auto.somanuals.com>

TV manuals search

<http://tv.somanuals.com>