

Invacare® Pronto® Air Personal Transporter w/ MyBody™ Seating

**EN Personal Transporter
User Manual**

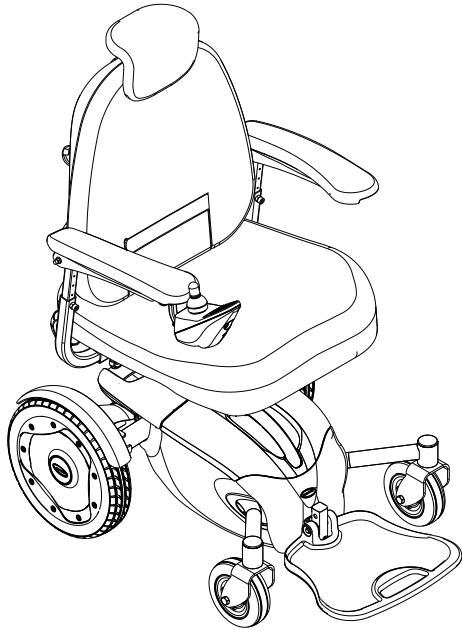

This manual **MUST** be given to the user of the product.
BEFORE using this product, read this manual and save for future reference.



Yes, you can.®

© 2012 Invacare® Corporation

All rights reserved. Republication, duplication or modification in whole or in part is prohibited without prior written permission from Invacare. Trademarks are identified by ™ and ®. All trademarks are owned by or licensed to Invacare Corporation or its subsidiaries unless otherwise noted.

Contents

I	General	5	4.1	Typical Product Parameters	24
1.1	Symbols.	5		Overall Dimensions	24
1.2	General Guidelines.	5		Seat.	24
	Operation Information	6		Wheels	24
1.3	Global Limited Warranty (Excluding Canada).	8		Battery	24
	Canada Limited Warranty	10		Footrests.	24
				Weight	24
2	Safety Handling.	12	5	Wheelchair Operation	25
2.1	Safety/Handling	12	5.1	Personal Transporter Usage	25
	A Note to Personal Transporter Assistants	13	5.2	SPJ™ + Joystick Switches and Indicators.	25
	Stability and Balance	13		On/Off Button	25
	Coping with Everyday Obstacles	14		Speedometer	25
	Pinch Points	15		Speed Control Button	25
	Footplate.	16		Joystick	26
	Reaching, Leaning and Bending - Forward.	16		Charger/Programming Input	26
	Reaching, Bending - Backward	17		Service Indicator	26
	Transferring To and From Other Seats	17		Information Gauge Display	26
	Storage	18	5.3	Using the Joystick to Drive the Chair	26
	Electrical - Grounding Instructions.	19	5.4	Disengaging/Engaging Motor Lock Levers.	27
	Electrical - Batteries	19	5.5	Removing/Installing the Battery Box From/Into the Personal Transporter	28
	Electrical - Charging Batteries	19	5.6	Removing/Installing the Seat Assembly.	29
	Weight Training.	20		Removing.	29
	Weight Limitation	20		Installing	29
	Electromagnetic Interference (EMI) From Radio Wave Sources	20	5.7	Using the Folding Back Assembly.	29
	Personal Transporter Electromagnetic Interference (EMI)	21	5.8	Transporting the Personal Transporter	30
3	Label Locations.	23	5.9	Charging Batteries	30
3.1	Pronto Air Personal Transporter	23		Description and Use of Battery Chargers.	31
4	Technical Data	24	6	Setup and Maintenance	32
			6.1	Preparing the Personal Transporter for Use.	32
			6.2	Setup/Delivery Inspection	32
			6.3	User/Attendant Inspection Checklists	33
				Inspect/Adjust Weekly	33

	Inspect/Adjust Monthly	33		Replacing the Batteries	44
	Inspect/Adjust Periodically	33		Disconnecting/Connecting the Battery	
6.4	Service Inspection	33		Cables	45
6.5	Joystick	34		Cleaning Battery Terminals	46
	Installing the Joystick	34		Resetting the Circuit Breaker	46
	Disconnecting/Connecting the Joysticks	35	7	Troubleshooting	47
	Adjusting the Joystick Depth	36	7.1	Driving Performance	47
6.6	Seat and Back	36	7.2	Electrical	48
	Adjusting the Seat Assembly Height	36		Information Gauge Diagnostics	48
	Seat Pan Depth	37	7.3	Checking Battery Charge Level	49
	Back Angle Adjustment	37	7.4	Usability Survey	50
	Adjusting the Headrest Height	37			
6.7	Armrest Assemblies	38			
	Adjusting Arm Width	38			
	Adjusting the Arm Height	38			
	Adjusting the Arm Pad Depth	39			
	Adjusting the Armrest Pad Angle (Left or				
	Right)	39			
	Adjusting the Armpad Angle (Up or Down)	40			
6.8	Footboard	40			
	Removing/Installing the Footboard or Adjusting				
	the Footboard Depth	40			
	Adjusting the Footboard Height	41			
	Adjusting the Footboard Angle	41			
6.9	Cushion Covers	42			
	Removing/Installing the Seat Cushion				
	Cover	42			
	Removing/Installing the Back Cushion Cover				
	42			
	Cleaning the Cushion Covers	42			
6.10	Adjusting Forks	42			
6.11	Batteries	43			
	Using the Proper Batteries	43			

I General

I.1 Symbols

Signal words are used in this manual and apply to hazards or unsafe practices which could result in personal injury or property damage. See the information below for definitions of the signal words.



DANGER!

- Danger indicates an imminently hazardous situation which, if not avoided, will result in death or serious injury.



WARNING!

- Warning indicates a potentially hazardous situation which, if not avoided, could result in death or serious injury.



CAUTION!

- Caution indicates a potentially hazardous situation which, if not avoided, may result in property damage or minor injury or both.



IMPORTANT

- Indicates a hazardous situation that could result in damage to property if it is not avoided.



Gives useful tips, recommendations and information for efficient, trouble-free use.

I.2 General Guidelines

This section contains important information for the safe operation and use of this product.

1171794-B



WARNING!

- Do not use this product or any available optional equipment without first completely reading and understanding these instructions and any additional instructional material such as the user manual, service manuals or instruction sheets supplied with this product or optional equipment. If you are unable to understand the warnings, cautions or instructions, contact a healthcare professional, dealer or technical personnel before attempting to use this equipment - otherwise, injury or damage may occur.
- Procedures other than those described in this manual must be performed by a qualified technician.
- Invacare products are specifically designed and manufactured for use in conjunction with Invacare accessories. Accessories designed by other manufacturers have not been tested by Invacare and are not recommended for use with Invacare products.
- **DO NOT** connect any medical devices such as ventilators, life support machines, etc. directly to the batteries used to power the personal transporter. This could cause unexpected failure of the device and the personal transporter.



THE INFORMATION CONTAINED IN THIS DOCUMENT IS SUBJECT TO CHANGE WITHOUT NOTICE.

Check all parts for shipping damage and test before using. In case of damage, **DO NOT** use. Contact Invacare/Carrier for further instruction

In some generalized warnings/cautions, the term personal transporter will be referred to as wheelchair.

 As a manufacturer of wheelchairs, Invacare endeavors to supply a wide variety of wheelchairs to meet many needs of the end user. However, final selection of the type of wheelchair to be used by an individual rests solely with the user and his/her healthcare professional capable of making such a selection. Invacare highly recommends working with a certified rehab technology supplier and/or a member of NRRTS or RESNA.

Operation Information



WARNING! **Setup**

- A qualified technician **MUST** perform the initial set up of this personal transporter. Also, a qualified technician **MUST** perform all procedures in the service manual.
- Performance adjustments should only be made by professionals of the healthcare field or persons fully conversant with this process and the driver's capabilities. Incorrect settings could cause injury to the driver, bystanders, damage to the personal transporter and to surrounding property.
- After the personal transporter has been set-up/adjusted, check to make sure that the personal transporter performs to the specifications entered during the set-up procedure. If the personal transporter does not perform to specifications, turn the personal transporter **Off** immediately and reenter set-up specifications. Repeat this procedure until the personal transporter performs to specifications.



WARNING! **Transport**

- **DO NOT** operate on roads, streets or highways.
- **DO NOT** transport an occupied personal transporter in a moving vehicle.
- As of this date, the Department of Transportation has not approved any tie-down systems for transportation of a user while in a wheelchair, in a moving vehicle of any type. It is Invacare's position that users of wheelchairs should be transferred into appropriate seating in vehicles for transportation and use be made of the restraints made available by the auto industry. Invacare cannot and does not recommend any wheelchair transportation systems.

Moving Unoccupied Personal Transporters

- To avoid injury or property damage when moving an unoccupied personal transporter down an incline, perform the following:
 - Engage motor lock levers.
 - Turn power on and adjust speed to minimal setting.
 - Drive personal transporter forward down incline.



WARNING! **Stairways and Escalators**

- **DO NOT** attempt to move an occupied personal transporter between floors using a stairway. Use an elevator to move an occupied personal transporter between floors.
- The weight of the personal transporter without the user is approximately 155 lbs. Use proper lifting techniques (lift with your legs) to avoid injury.



WARNING!

Stairways and Escalators

- If moving the personal transporter between floors by means of a stairway, the occupant **MUST** be removed and transported independently of the personal transporter components.
- The seat **MUST** be removed from the personal transporter base before moving it up or down the stairs. No upward force should be applied to the seat to move the chair.
- The personal transporter base weighs 100 lbs with the battery box installed. Invacare recommends removing the battery box and transporting it independently from the base.
- Invacare recommends using two assistants and making thorough preparations. Make sure to use **ONLY** secure, non-detachable parts for hand-hold supports.
- **DO NOT** use an escalator to move a personal transporter between floors. Serious bodily injury may occur.
- **DO NOT** attempt to lift the personal transporter by any removable (detachable) parts. Lifting by means of any removable (detachable) parts of a personal transporter may result in injury to the user or damage to the personal transporter.

Follow this procedure for moving the personal transporter between floors when an elevator is **NOT** available:



When using a stairway to move the personal transporter and any accessories, move all personal transporter components away from the stairway prior to reassembly.

1. Remove the occupant from the personal transporter.
2. Remove then seat. Refer to 5.6 Removing/Installing the Seat Assembly, page 29.
3. Remove the battery box from personal transporter. Refer to 5.5 Removing/Installing the Battery Box From/Into the Personal Transporter, page 28.
4. Bend your knees and keep your back straight.
5. Fold the foot plate up against the front of the personal transporter.
6. Using the foot plate hand hold and the base handle located at the rear of the personal transporter, lift the personal transporter off of the ground and transfer the personal transporter up or down the stairs.
7. The personal transporter should not be lowered until the last stair has been negotiated and the personal transporter has been carried away from the stairway.



WARNING!

Repair or Service Information

- **PERSONAL TRANSPORTER USERS: DO NOT** service or operate this equipment without first reading and understanding (1) the owner's operator and maintenance manual and (2) the seating system's manual (if applicable). If you are unable to understand the warnings, cautions, and instructions, contact Invacare technical support before attempting to service or operate this equipment - otherwise injury or damage may result.
- **DEALERS AND QUALIFIED TECHNICIANS: DO NOT** service or operate this equipment without first reading and understanding (1) the owner's operator and maintenance manual, (2) the service manual (if applicable) and (3) the seating system's manual (if applicable). If you are unable to understand the warnings, cautions and instructions, contact Invacare technical support before attempting to service or operate this equipment - otherwise, injury or damage may result.
- Set-up of the Electronics Control Unit is to be performed only by a qualified technician. The final adjustments of the controller may affect other activities of the personal transporter. Damage to the equipment and/or unintended use could occur if improperly set-up or adjusted.



WARNING!

Repair or Service Information

- Personal Transporters should be examined during maintenance for signs of corrosion (water exposure, incontinence, etc.). If corrosion is found, contact Invacare or your dealer. Electrical components damaged by corrosion should be replaced **IMMEDIATELY**.
- Personal transporters that are used by incontinent users and/or are frequently exposed to water may require replacement of electrical components more frequently.
- **DO NOT** overtighten hardware attaching to the frame. This could cause damage to the frame tubing.
- Transport ready packages are not retrofittable to existing models and are not field serviceable.
- Except for programming, **DO NOT** service or adjust the personal transporter while occupied, unless otherwise noted.
- Before adjusting, repairing or servicing the personal transporter, always turn the personal transporter power Off, otherwise, injury or damage may occur.

1.3 Global Limited Warranty (Excluding Canada)



PLEASE NOTE: THE WARRANTY BELOW HAS BEEN DRAFTED TO COMPLY WITH FEDERAL LAW APPLICABLE TO PRODUCTS MANUFACTURED AFTER JULY 4, 1975.

This warranty is extended only to the original purchaser who purchases this product within any country excluding CANADA when new and unused from Invacare or a dealer. This warranty is not extended to any other person or entity and is not transferable

or assignable to any subsequent purchaser or owner. Coverage under this warranty will end upon any such subsequent sale or other transfer of title to any other person. For product purchased in Canada, please refer to the Canada Limited Warranty.

This warranty gives you specific legal rights and you may also have other legal rights which vary from state to state.

Invacare warrants the base frame to be free from defects in materials and workmanship for a period of five (5) years from the date of purchase from Invacare or a dealer, with a copy of the seller's invoice required for coverage under this warranty. Invacare warrants all electronics and electrical components (excluding batteries), motors, powered seating actuators and gearboxes to be free from defects in materials and workmanship for a period of one (1) year from the date of purchase from Invacare or a dealer, with a copy of the seller's invoice required for coverage under this warranty. Invacare warrants all batteries to be free from defects in materials and workmanship for a period of six (6) months from the date of purchase from Invacare or a dealer, with a copy of the seller's invoice required for coverage under this warranty. Invacare warrants all remaining components (excluding all upholstered materials, padded materials, tires and wheels) to be free from defects in materials and workmanship for a period of one (1) year from the date of purchase from Invacare or a dealer, with a copy of the seller's invoice required for coverage under this warranty. If within such warranty periods any such product component shall be proven to be defective, the product component shall be repaired or replaced, at Invacare's option. This warranty does not include any labor or shipping charges incurred in replacement part installation or repair of any such product. Invacare's sole obligation and your exclusive remedy under this warranty shall be limited to such repair and/or replacement.

For warranty service, please contact the dealer from whom you purchased your Invacare product. In the event you do not receive

satisfactory warranty service, please write directly to Invacare at the address on the bottom of the back cover. Provide dealer's name address, date of purchase, indicate nature of the defect and, if the product is serialized, indicate the serial number. Do not return products to our factory without our prior consent.

Limitations and Exclusions: The foregoing warranty shall not apply to serial numbered products if the serial number has been removed or defaced, products subject to negligence, accident, improper operation, maintenance or storage, commercial or institutional use, products modified without Invacare's express written consent (including, but not limited to, modification through the use of unauthorized parts or attachments); products damaged by reason of repairs made to any component without the specific consent of Invacare, or to a product damaged by circumstances beyond Invacare's control, and such evaluation will be solely determined by Invacare. The warranty shall not apply to problems arising from normal wear and tear or failure to adhere to the product instructions. A change in operating noise, particularly relative to motors and gearboxes does not constitute a failure or defect and will not be repaired; all devices will exhibit changes in operating noise due to aging.

The foregoing express warranty is exclusive and in lieu of any other warranties whatsoever, whether express or implied, including the implied warranties of merchantability and fitness for a particular purpose, and the sole remedy for violations of any warranty whatsoever, shall be limited to repair or replacement of the defective product pursuant to the terms contained herein. the application of any implied warranty whatsoever shall not extend beyond the duration of the express warranty provided herein and Invacare shall not be liable for any consequential or incidental damages whatsoever; **SOME STATES DO NOT ALLOW THE EXCLUSION OR LIMITATION OF INCIDENTAL OR CONSEQUENTIAL DAMAGE,**

OR LIMITATION OF HOW LONG AN IMPLIED WARRANTY LASTS, SO THE ABOVE EXCLUSION AND LIMITATION MAY NOT BE APPLICABLE.

THIS WARRANTY SHALL BE EXTENDED TO COMPLY WITH STATE/PROVINCIAL LAWS AND REQUIREMENTS.

Canada Limited Warranty

This warranty is extended only to the original purchaser who purchases this product within Canada when new and unused from Invacare or a dealer. This warranty is not extended to any other person or entity and is not transferable or assignable to any subsequent purchaser or owner. Coverage under this warranty will end upon any such subsequent sale or other transfer of title to any other person.

This warranty gives you specific legal rights and you may also have other legal rights which vary from state to state.

Invacare warrants the base frame to be free from defects in materials and workmanship for a period of five (5) years from the date of purchase from Invacare or a dealer, with a copy of the seller's invoice required for coverage under this warranty. Invacare warrants all electronics and electrical components (excluding batteries), powered seating actuators, 2-pole motors and gearboxes to be free from defects in materials and workmanship for a period of two (2) years from the date of purchase from Invacare or a dealer, with a copy of the seller's invoice required for coverage under this warranty. Invacare warrants all batteries to be free from defects in materials and workmanship for a period of six (6) months from the date of purchase from Invacare or a dealer, with a copy of the seller's invoice required for coverage under this warranty. Invacare warrants all remaining components (excluding all upholstered materials, padded materials, tires and wheels) to be free from defects in materials and workmanship for a period of one (1) year from the date of purchase

from Invacare or a dealer, with a copy of the seller's invoice required for coverage under this warranty. If within such warranty periods any such product component shall be proven to be defective, the product component shall be repaired or replaced, at Invacare's option. This warranty does not include any labor or shipping charges incurred in replacement part installation or repair of any such product. Invacare's sole obligation and your exclusive remedy under this warranty shall be limited to such repair and/or replacement.

For warranty service, please contact the dealer from whom you purchased your Invacare product. In the event you do not receive satisfactory warranty service, please write directly to Invacare at the address on the bottom of the back cover. Provide dealer's name address, date of purchase, indicate nature of the defect and, if the product is serialized, indicate the serial number. Do not return products to our factory without our prior consent.

Limitations and Exclusions: The foregoing warranty shall not apply to serial numbered products if the serial number has been removed or defaced, products subject to negligence, accident, improper operation, maintenance or storage, commercial or institutional use, products modified without Invacare's express written consent (including, but not limited to, modification through the use of unauthorized parts or attachments); products damaged by reason of repairs made to any component without the specific consent of Invacare, or to a product damaged by circumstances beyond Invacare's control, and such evaluation will be solely determined by Invacare. The warranty shall not apply to problems arising from normal wear and tear or failure to adhere to the product instructions. A change in operating noise, particularly relative to motors and gearboxes does not constitute a failure or defect and will not be repaired; all devices will exhibit changes in operating noise due to aging.

The foregoing express warranty is exclusive and in lieu of any other warranties whatsoever, whether express or implied, including the implied warranties of merchantability and fitness for a particular purpose, and the sole remedy for violations of any warranty whatsoever, shall be limited to repair or replacement of the defective product pursuant to the terms contained herein. the application of any implied warranty whatsoever shall not extend beyond the duration of the express warranty provided herein and Invacare shall not be liable for any consequential or incidental damages whatsoever; SOME STATES DO NOT ALLOW THE EXCLUSION OR LIMITATION OF INCIDENTAL OR CONSEQUENTIAL DAMAGE, OR LIMITATION OF HOW LONG AN IMPLIED WARRANTY LASTS, SO THE ABOVE EXCLUSION AND LIMITATION MAY NOT BE APPLICABLE.

THIS WARRANTY SHALL BE EXTENDED TO COMPLY WITH STATE/PROVINCIAL LAWS AND REQUIREMENTS.

2 Safety Handling

2.1 Safety/Handling

“Safety and Handling” of the personal transporter requires the close attention of the personal transporter user as well as the assistant. This manual points out the most common procedures and techniques involved in the safe operation and maintenance of the personal transporter. It is important to practice and master these safe techniques until you are comfortable in maneuvering around the frequently encountered architectural barriers.

Use this information only as a “basic” guide. The techniques that are discussed on the following pages have been used successfully by many.

Users and assistants **MUST** be aware that the handling and maneuverability characteristics of rear wheel drive personal transporters are inherently different from center and front wheel drive wheelchairs. Handling and maneuverability differences will be most noticeable when traveling up or down ramps and slopes or over obstacles and rough terrain as this may shift the users center of mass resulting in decreased stability. **ALWAYS** reduce speed and wear the seat positioning strap when driving under these conditions.

Individual personal transporter users often develop skills to deal with daily living activities that may differ from those described in this manual. Invacare recognizes and encourages each individual to try what works best for him/her in overcoming architectural obstacles that they may encounter. However all warnings and cautions given in this manual **MUST** be followed. Techniques in this manual are a starting point for the new personal transporter user and assistant with “safety” as the most important consideration for all.

Invacare strongly recommends that initial use of the personal transporter be supervised by an assistant.



WARNING!

- If personal transporter starts smoking, sparking, or burning, discontinue using the personal transporter and seek service **IMMEDIATELY**.
- **ALWAYS** wear your seat positioning strap. The seat positioning strap is a positioning belt only. It is not designed for use as a safety device withstanding high stress loads such as auto or aircraft safety belts. If signs of wear appear, belt **MUST** be replaced **IMMEDIATELY**.
- **DO NOT** leave the power button On when entering or exiting the personal transporter.
- **DO NOT** go up or down ramps or traverse slopes greater than 6°.
- **NEVER** leave an unoccupied personal transporter unattended on an incline.
- **DO NOT** attempt to move up or down an incline with water, ice or oil film.
- Do determine and establish your particular safety limits by practicing bending, reaching and transferring activities in the presence of a qualified healthcare professional before attempting active use of the personal transporter.
- **DO NOT** attempt to reach objects if you have to move forward in your seat.
- **ALWAYS** shift your weight in the direction you are turning. **DO NOT** shift your weight in the opposite direction of the turn. Shifting your weight in the opposite direction of the turn may cause the inside drive wheel to lose traction and the personal transporter to tip over.

**WARNING!**

- DO NOT shift your weight or sitting position toward the direction you are reaching as the personal transporter and/or seating system (if any) may tip over.
- ALWAYS keep hands and fingers clear of moving parts to avoid injury.
- DO NOT use with a broken or missing joystick knob.
- DO NOT use if joystick does not spring back to the neutral position or becomes sticky or sluggish.
- DO NOT use if joystick boot is torn or damaged.
- DO NOT engage or disengage the motor locks until the power is in the off position.

A Note to Personal Transporter Assistants

When assistance to the personal transporter user is required, remember to use good body mechanics. Keep your back straight and bend your knees whenever tilting personal transporter or traversing curbs or other impediments.

**WARNING!**

- Also, be aware of detachable parts such as arms, legrests, or the seat. These **MUST NEVER** be used to move the personal transporter or as lifting supports, as they may be inadvertently released, resulting in possible injury to the user and/or assistant(s)

When learning a new assistance technique, have an experienced assistant help you before attempting it alone.

Stability and Balance**WARNING!**

- ALWAYS wear your seat positioning strap. The seat positioning strap is a positioning belt only. It is not designed for use as a safety device withstanding high stress loads such as auto or aircraft safety belts. If signs of wear appear, belt **MUST** be replaced **IMMEDIATELY**.
- DO NOT use on inclines greater than 6°.
- DO NOT use on inclines with wet, slippery, icy or oily surfaces. This may include certain painted or otherwise treated wood surfaces.
- DO NOT traverse down ramps at high speed. Doing so will reduce traction and increase stopping distance.
- ALWAYS traverse down ramps at a reduced, constant speed to maintain stability and to avoid hard braking or sudden stops.
- The end user's weight can materially affect traction on sloped surfaces. Great care should be taken when traversing such slopes.
- ALWAYS reduce speed when traveling up or down an incline or over obstacles and rough terrain. Traveling under these conditions may shift the users weight forward resulting in reduced stability.
- Exercise caution and avoid sudden stops when traveling up or down an incline or over obstacles and rough terrain. If stopping becomes necessary under these driving conditions, release the joystick and allow the personal transporter to come to a full stop. Then proceed at a slower speed



WARNING!

- To determine and establish your particular safety limits, practice use of this product on various sloping surfaces in the presence of a qualified healthcare provider before attempting active use of this personal transporter. Other general warnings listed within this document also apply.
- Be aware that carrying heavy objects on your lap or on the accessory hooks while occupying the personal transporter may adversely affect the stability of the personal transporter, resulting in serious bodily injury to the user, damage to the personal transporter and surrounding property.
- This personal transporter has been designed to accommodate one individual. If more than one individual occupies the personal transporter this may adversely affect the stability of the personal transporter, resulting in serious bodily injury to the user and passenger and damage to the personal transporter and surrounding property.
- Do determine and establish your particular safety limits by practicing bending, reaching and transferring activities in the presence of a qualified healthcare professional before attempting active use of the personal transporter.



WARNING!

- Many activities require the personal transporter user to reach, bend and transfer in and out of the personal transporter. These movements will cause a change to the normal balance, center of gravity, and weight distribution of the personal transporter. To determine and establish your particular safety limits, practice bending, reaching and transferring activities in several combinations in the presence of a qualified healthcare professional before attempting active use of the personal transporter.
- DO NOT stand on anywhere on the personal transporter (frame, footboard, etc..).

To assure stability and proper operation of your personal transporter, you must at all times maintain proper balance. Your personal transporter has been designed to remain upright and stable during normal daily activities as long as you DO NOT move beyond the center of gravity. DO NOT lean forward out of the personal transporter any further than the length of the armrests.

Coping with Everyday Obstacles

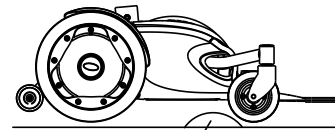

Bump/Threshold

Coping with the irritation of everyday obstacles can be somewhat alleviated by learning how to manage your personal transporter. Keep in mind your center of gravity to maintain stability and balance.

While the personal transporter is designed for use primarily in and around the home, the provider should determine whether this personal transporter is suitable for the actual environment in which the personal transporter will be used.



WARNING!

- DO NOT attempt to drive over curbs or obstacles greater than 2 inches (50mm). Doing so may cause your personal transporter to turn over and cause bodily harm or damage to the personal transporter. Always stop before climbing an obstacle. Approach slowly until casters contact the obstacle. Slowly apply power and drive over obstacle.



CAUTION!

- Be aware of the condition of the ramp. Traction will be diminished/non existent on a slippery surface. Proceed with caution.

i DO NOT go down a ramp at full speed. Some seat/back positions will cause the personal transporter to feel unstable.

Pinch Points

DETAIL "A"

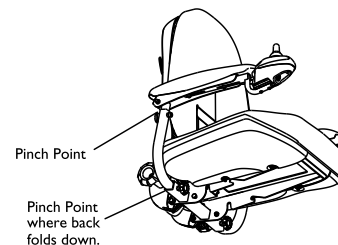

DETAIL "B"

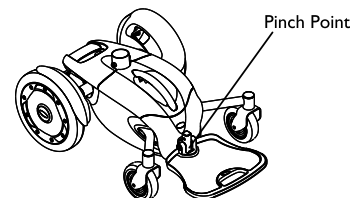

WARNING!

- DO NOT store or place items under the seat.
- Pinch point may occur when adjusting the arm angle position (Detail "A").
- Pinch point may occur when rotating the footboard assembly (Detail "B").

Footplate



WARNING!

- If the personal transporter dips forward and the footplates touch the ground while the personal transporter is in motion, please contact your dealer for an inspection and avoid use of the personal transporter if possible. Otherwise the user could be injured.
- **DO NOT** use the footplate as a platform. When getting in or out of the personal transporter, make sure that the footplate is in the upward position.

Reaching, Leaning and Bending - Forward



WARNING!

- **DO NOT** attempt to reach objects if you have to move forward in the seat or pick them up from the floor by reaching down between your knees.
- Proper positioning is essential for your safety. Improper positioning while leaning or bending could cause the personal transporter to tip forward onto anti-tippers.

1. Engage motor locks and turn power off before reaching, leaning or bending only as far as your arm will extend without changing your sitting position.
2. Engage wheel locks/motor locks/clutches.

Reaching, Bending - Backward



WARNING!

- DO NOT lean over the top of the seat back. This will change your center of gravity and may cause you to tip over.
- Proper positioning is essential for your safety. When reaching, leaning, bending or bending backward, it is important to use the casters as a tool to maintain stability and balance.

1. Position personal transporter as close as possible to the desired object.
2. Engage the motor locks and turn power off.
3. Reach back only as far as your arm will extend without changing your sitting position.

Transferring To and From Other Seats

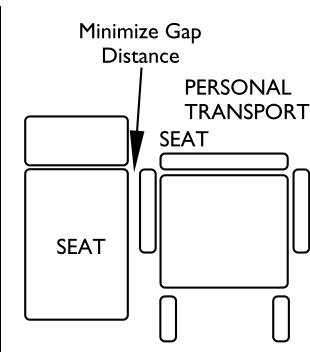
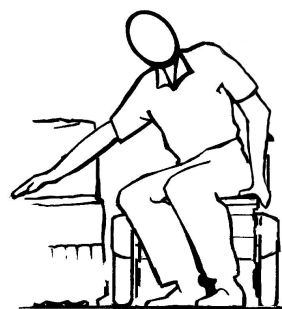

WARNING!

- Always turn the personal transporter power OFF and engage the motor locks/clutches to prevent the wheels from moving before attempting to transfer in or out of the personal transporter. Also, make sure every precaution is taken to reduce the gap distance. Align both casters parallel with the object you are transferring onto.



Adequate mobility and upper body strength is required to perform this activity independently.

1. Position the personal transporter to minimize the gap distance between the personal transporter seat and the seat to which you are transferring.
2. Ensure the casters are aligned parallel with the object.
3. Ensure footrest is in up position.
4. Unless being used for support, place armrests in vertical position.
5. Engage motor locks.
6. Shift body weight into seat with transfer.



During independent transfer, little or no seat platform will be beneath you. Use a transfer board if at all possible.

Storage



WARNING!

- Avoid storing or using the personal transporter near open flame or combustible products. Serious injury or damage to property may result.
- Invacare has tested its personal transporters in accordance with RESNA WC — 2:2009, Section 9 Part 7.3 “Rain Test”. This provides the end user or his/her attendant sufficient time to remove his/her personal transporter from a rain storm and retain personal transporter operation.
- DO NOT leave personal transporter in a rain storm of any kind.
- DO NOT use personal transporter in a shower.
- DO NOT leave personal transporter in a damp area for any length of time.
- Direct exposure to rain or dampness will cause the personal transporter to malfunction electrically and mechanically; may cause the personal transporter to prematurely rust or may damage the upholstery.
- Check to ensure that the battery covers are secured in place, joystick boot is NOT torn or cracked where water can enter and that all electrical connections are secure at all times.



WARNING!

- DO NOT use if the joystick boot is torn or cracked. If the joystick boot becomes torn or cracked, replace IMMEDIATELY.

Electrical - Grounding Instructions



WARNING!

- DO NOT under any circumstances cut or remove the round grounding plug from the charger AC cable plug or the extension cord plug.
- DO NOT, under any circumstances, cut or remove the round grounding prong from any plug used with or for Invacare products. Some devices are equipped with three-prong (grounding) plugs for protection against possible shock hazards. Where a two-prong wall receptacle is encountered, it is the personal responsibility and obligation of the customer to contact a qualified electrician and have the two-prong receptacle replaced with a properly grounded three-prong wall receptacle in accordance with the National Electrical Code. If you must use an extension cord, use only a three-wire extension cord having the same or higher electrical rating as the device being connected. In addition, Invacare has placed RED/ORANGE warning tags on some equipment. DO NOT remove these tags.

Electrical - Batteries



WARNING!

- The warranty and performance specifications contained in this manual are based on the use of deep cycle AGM cell batteries. Invacare strongly recommends their use as the power source for this unit.
- Carefully read battery/battery charger information prior to installing, servicing or operating your personal transporter.

Electrical - Charging Batteries



DANGER!

- When using an extension cord, use an extension cord having at least 16 AWG (American Wire Gauge) wire and the same or higher electrical rating as the device being connected. Use of improper extension cord could result in a risk of fire and electric shock.
- NEVER attempt to recharge the batteries by attaching cables directly to the battery terminals.
- DO NOT attempt to recharge the batteries and operate the personal transporter at the same time.
- DO NOT operate personal transporter with extension cord attached to the AC cable.
- DO NOT attempt to recharge the batteries when the personal transporter has been exposed to any type of moisture.



WARNING!

- DO NOT attempt to recharge the batteries when the personal transporter is outside.
- DO NOT sit in the personal transporter while charging the batteries.



WARNING!

- READ and CAREFULLY follow the manufacturer's instructions for each charger (supplied or purchased). If charging instructions are not supplied, consult a qualified technician for proper procedures.
- Ensure the pins of the extension cord plug are the same number, size, and shape as those on the charger.
- DO NOT under any circumstances cut or remove the round grounding plug from the charger AC cable plug or the extension cord plug.

Weight Training

Invacare DOES NOT recommend the use of its personal transporters as a weight training apparatus. Invacare personal transporters have NOT been designed or tested as a seat for any kind of weight training. If occupant uses said personal transporter as a weight training apparatus, Invacare shall NOT be liable for bodily injury and the warranty is void.

Weight Limitation



WARNING!

- Refer to 4.1 Typical Product Parameters, page 24 to determine the weight limit (total combined weight of user and any attachments) of your personal transporter model. Do not exceed the limit - otherwise, injury or damage may result.
- The maximum weight limit for the accessory hooks is 40 lbs. Exceeding the 40 lb weight limitation on the accessory hooks may adversely affect the stability of the personal transporter, resulting in serious bodily injury to the user, damage to the personal transporter and surrounding property.

Electromagnetic Interference (EMI) From Radio Wave Sources

Personal transporters may be susceptible to electromagnetic interference (EMI), which is interfering electromagnetic energy (EM) emitted from sources such as radio stations, TV stations, amateur radio (HAM) transmitters, two way radios, and cellular phones. The interference (from radio wave sources) can cause the personal transporter to release its brakes, move by itself, or move in unintended directions. It can also permanently damage the personal transporter control system. The intensity of the interfering EM energy can be measured in volts per meter (V/m). Each personal transporter can resist EMI up to a certain intensity. This is called its "immunity level." The higher the immunity level, the greater the protection. At this time, current technology is capable of achieving at least a 20 V/m immunity level, which would provide useful protection from the more common sources of radiated EMI.

There are a number of sources of relatively intense electromagnetic fields in the everyday environment. Some of these sources are

obvious and easy to avoid. Others are not apparent and exposure is unavoidable. However, we believe that by following the warnings listed below, your risk to EMI will be minimized.

The sources of radiated EMI can be broadly classified into three types:

1. Handheld Portable transceivers (transmitters/receivers with the antenna mounted directly on the transmitting unit. Examples include: citizens band (CB) radios, "walkie talkie", security, fire and police transceivers, cellular telephones, and other personal communication devices).
 -  Some cellular telephones and similar devices transmit signals while they are ON, even when not being used.
2. Medium range mobile transceivers, such as those used in police cars, fire trucks, ambulances and taxis. These usually have the antenna mounted on the outside of the vehicle; and
3. Long range transmitters and transceivers, such as commercial broadcast transmitters (radio and TV broadcast antenna towers) and amateur (HAM) radios.

-  Other types of handheld devices, such as cordless phones, laptop computers, AM/FM radios, TV sets, CD players, cassette players, and small appliances, such as electric shavers and hair dryers, so far as we know, are not likely to cause EMI problems to your personal transporter.

these devices. This can affect personal transporter movement and braking. Therefore, the warnings listed below are recommended to prevent possible interference with the control system of the personal transporter.

Electromagnetic interference (EMI) from sources such as radio and TV stations, amateur radio (HAM) transmitters, two-way radios, and cellular phones can affect the personal transporter.

Following the warnings listed below should reduce the chance of unintended brake release or personal transporter movement which could result in serious injury.

Personal Transporter Electromagnetic Interference (EMI)

Because EM energy rapidly becomes more intense as one moves closer to the transmitting antenna (source), the EM fields from handheld radio wave sources (transceivers) are of special concern. It is possible to unintentionally bring high levels of EM energy very close to the personal transporter's control system while using



WARNING!

Personal Transporter Electromagnetic Interference (EMI)

- DO NOT operate handheld transceivers (transmitters receivers), such as citizens band (CB) radios, or turn ON personal communication devices, such as cellular phones, while the personal transporter is turned ON;
- Be aware of nearby transmitters, such as radio or TV stations, and try to avoid coming close to them;
- If unintended movement or brake release occurs, turn the personal transporter OFF as soon as it is safe;
- Be aware that adding accessories or components, or modifying the personal transporter, may make it more susceptible to EMI (Note: There is no easy way to evaluate their effect on the overall immunity of the personal transporter); and
- Report all incidents of unintended movement or brake release to the personal transporter manufacturer, and note whether there is a source of EMI nearby.

Important Information

- 20 volts per meter (V/m) is a generally achievable and useful immunity level against EMI (as of May 1994) (the higher the level, the greater the protection);
- This device has been tested to a radiated immunity level of 20 volts per meter.
- The immunity level of the product is unknown.
- Modification of any kind to the electronics of this scooter as manufactured by Invacare may adversely affect the EMI immunity levels.

3 Label Locations

3.1 Pronto Air Personal Transporter

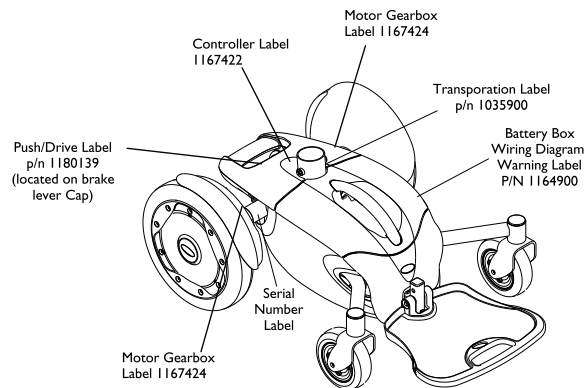

Seat Positioning Strap Label
P/N 1134811

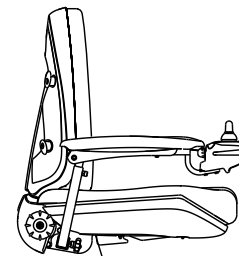
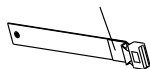

Weight Capacity Label

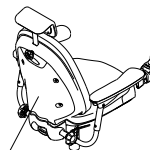

Date Code Label

4 Technical Data

4.1 Typical Product Parameters



All dimensions are ± .50 inches unless otherwise indicated.

Overall Dimensions

Base Width (Without Joystick):	23.5 inches
Base Length:	37.8 inches (With Foot plate)
Overall Height:	Base with Seat: 42 - 48 inches, Base Only: 15 - 19 inches,

Seat

Seat-to-Floor Height:	21 to 25 inches in 1 inch increments
Seat Depth	18 to 20 inches deep
Back Height:	21 inches (without Head Rest)
Back Angle Adjustment:	22° Range of Adjustment ± 5°
Armrests:	Adjustable Width, Angle, Heights and Depth

Wheels

Caster:	6 x 2 inch Urethane with Precision Sealed Bearings
Caster Forks:	Two sided fork

Drive Wheel/Tires:	12 x 2.5 inches Urethane
Drive Axle:	Non-adjustable

Battery

Battery Requirements:	17 AH
-----------------------	-------

Footrests

Footboard:	Footboard (1 inch adjustable height, 1.5 inch adjustable depth)
------------	---

Weight

Weight (Base Only)	105 lbs
Without Batteries:	75lbs
Seat Weight (with Arms)	55 lbs
Batteries	30 lbs total (15 lbs each)
*Maximum Weight Limitations:	Up to 250 lbs



*Weight limitation is total weight (user weight plus any additional items that the user may require [back pack, etc.]). Example: If weight limitation of the personal transporter is 250 lbs and additional items equal 25 lbs, subtract 25 lbs from 250 lbs this means the maximum weight limitation of the user is 225 lbs.

5 Wheelchair Operation

5.1 Personal Transporter Usage



WARNING!

- After ANY adjustments, repair or service and before use, make sure that all attaching hardware is tightened securely - otherwise injury or damage may result.
- Set-up/programming of the Electronic Control Unit is to be performed only by a qualified technician. The fine tuning adjustments of the controller may affect other activities of the personal transporter. Damage to the equipment could occur under these circumstances. If unqualified individuals perform any work on these units, the warranty is void.



The personal transporter ships in two cartons. It is necessary to install the seat onto the personal transporter base, install the joystick and make any necessary adjustments to fit the personal transporter to the user. Refer to 6.1 Preparing the Personal Transporter for Use, page 32.

Setup of the personal transporter should be performed by dealer at time of delivery.

5.2 SPJ™ + Joystick Switches and Indicators

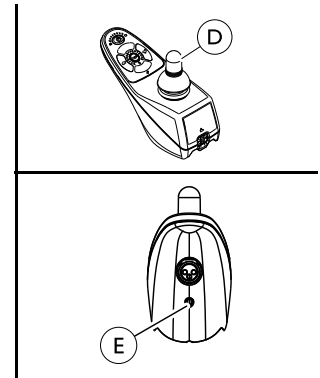
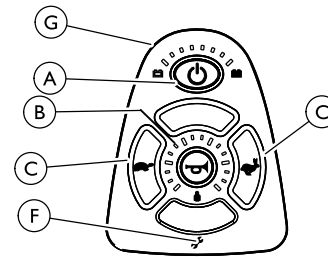

On/Off Button

The on/off button **A** is located at the front of the joystick housing. It is used to turn the personal transporter on and off, to remove the joystick from sleep mode (if programmed) and to lock or unlock the joystick (if programmed).



Speedometer

The speedometer **B** is used to show the maximum speed. The right-most LED indicates current maximum speed setting.









Speed Control Button

The speed control buttons **C** are located on the face of the joystick housing. These buttons are used for controlling the speed and acceleration of the personal transporter.



The speed control buttons [tortoise button () and hare button ()] are used to set and adjust the maximum speed.

- I. To adjust the speed, perform one of the following:

- Adjust Speed in 20% Increments (5 Speed Mode) - Press the tortoise button  or hare button  to decrease/increase the speed in 20% increments. The larger bars in the speedometer will light.
- Adjust Speed in Smaller Increments (VSP Mode) - Perform the following steps:
 - a. Press and hold both the tortoise button  and hare button  until the joystick beeps.
 - b. Perform one of the following:
 - Press the tortoise button  or hare button  to decrease/increase the speed in 20% increments. The larger bars in the speedometer will light.
 - Press and hold the tortoise button  or hare button  to decrease/increase the speed in smaller increments. The smaller bars in the speedometer will light.

Joystick

The joystick  has proportional drive control, meaning that further the joystick is pushed from the upright (neutral) position, the faster the personal transporter moves. Your top speed, however, is limited by the programmed settings.

To slow the personal transporter to a stop, simply release the joystick. The personal transporter has automatic speed and direction compensation to minimize corrections.

Charger/Programming Input



The charger/programming input  is located at the front of the joystick housing. This provides easy access for charging the personal transporter batteries. This port also serves as the Remote

Programmer Communication connection. Driving is prevented while the system is charging.

Service Indicator

The AMBER service indicator  will light when an error or fault occurs. Refer to Diagnostic Codes in Electronics manual I110532 for a listing of the flash codes and what they indicate.

Information Gauge Display

 The Information Gauge Display  is located on the front of the joystick housing, it provides the following information to the user on the status of the personal transporter

1. Power is on.
2. True state-of-battery-charge, including notification of when the battery requires charging:
 - a. Green LEDs are lit, indicating well charged batteries.
 - b. Amber LEDs are lit, indicating batteries are moderately charged. Recharge batteries before taking a long trip.
 - c. Red LEDs are lit, indicating batteries are running out of charge. Recharge batteries as soon as possible.

 The Information Gauge display also serves as a system diagnostic device when a fault is detected by the control module. A specific number of flashes of the LEDs indicate the type of fault detected. Refer to 7.2 Electrical, page 48

5.3 Using the Joystick to Drive the Chair

The joystick is located on the joystick housing and provides smooth control of speed and direction. It is equipped with 360 degrees of mobility for ease of operation. The joystick is spring-loaded, and automatically returns to the upright (neutral) position when released. Pushing the joystick in a given direction causes the

personal transporter to move in that direction. The joystick has proportional drive control, meaning that the further it is pushed from the upright (neutral) position, the faster the personal transporter moves. The maximum speed, however, is limited by the setting of the speed-control knob. To slow the personal transporter to a stop, simply release the joystick. The personal transporter has automatic speed and direction compensation to minimize corrections. When first learning to drive, select a slow speed and try to drive the personal transporter as slowly as possible by pushing the joystick slightly forward. This exercise will help you learn to utilize the full potential of the proportional control and allow you to start and stop smoothly.

To drive the personal transporter, perform the following

1. Adjust speed control knob to the appropriate setting.
2. Turn the power On.
3. Maneuver the joystick in the following manner:

MOVEMENT	ACTION
FORWARD	Push joystick forward, towards the front of the personal transporter.
REVERSE	Pull joystick back, towards the rear of the personal transporter.
Turn RIGHT	Move joystick toward the right side of the personal transporter.

Turn LEFT	Move joystick toward the left side of the personal transporter.
STOP	Release the joystick and the personal transporter will slow to a stop.

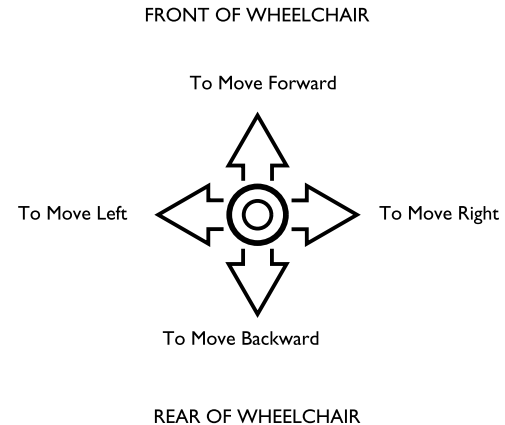

5.4 Disengaging/Engaging Motor Lock Levers



WARNING!

– DO NOT engage or disengage motor locks until the power is in the OFF position.



CAUTION!

– Ensure both motor release levers are fully engaged before driving the personal transporter.

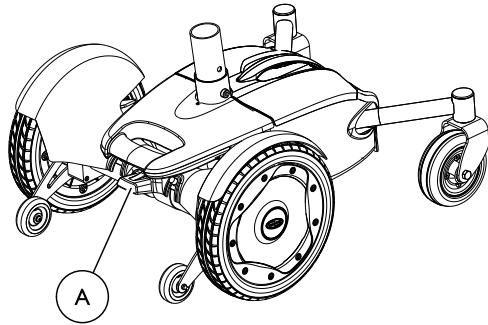

i Motor lock disengagement/engagement allows free-wheeling or joystick controlled operation. Free-wheeling allows an assistant to maneuver the personal transporter without power. Motor lock levers are located on each fender between the drive wheel and the personal transporter base frame.

- I. Perform one of the following:
 - Engage (DRIVE) - Push motor lock foot lever (A) down, towards the ground/floor.
 - Disengage (PUSH) - Pull motor lock foot lever (A) up towards the seat.

5.5 Removing/Installing the Battery Box From/Into the Personal Transporter



CAUTION!

– Place the personal transporter in a well ventilated area where work can be performed without risking damage to carpeting or floor covering.

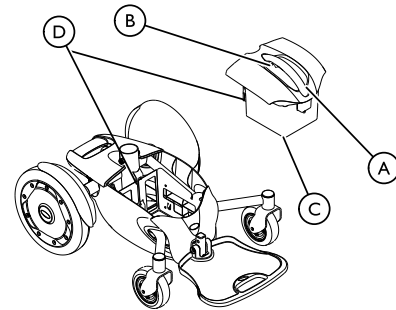

1. Ensure personal transporter power is turned off.
2. Remove the seat. Refer to 5.6 Removing/Installing the Seat Assembly, page 29.
3. Grasp the battery box handle (A) and squeeze the release trigger (B).
4. Lift the battery box (C) up to disconnect the battery box connectors (D) and remove the battery box from the personal transporter base.
5. Reverse STEPS 3-4 to reinstall the battery box .

5.6 Removing/Installing the Seat Assembly

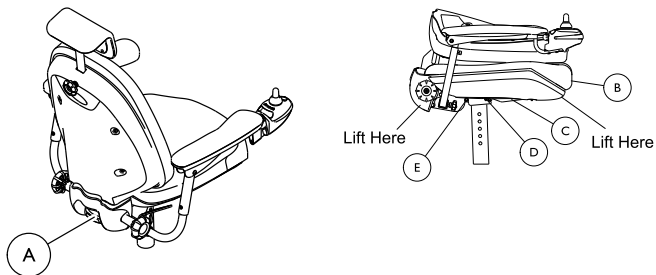

Removing

1. Disconnect the joystick. Refer to Disconnecting/Connecting the Joysticks, page 35.
2. Fold down the seat back. Refer to 5.7 Using the Folding Back Assembly, page 29.
3. Lift the seat lever (A) up to release the seat.
4. While holding the seat lever, lift the rear of the seat assembly (B) to tilt the seat assembly up.



WARNING!

– DO NOT use armrests to lift seat, otherwise injury or damage may occur. Use lifting locations shown in illustration.

5. Pull seat upward towards the rear of the personal transporter and remove the seat assembly from the seat post mounting pins.

Installing

1. Place the seat mounting bracket (C) onto the seat mounting pins and slide the seat assembly forward until the front seat mounting pin (D) engages the front slot in the seat mounting bracket.
2. Lower the rear of the seat until the rear seat mounting pin (E) clicks and locks into the seat mount bracket.
3. Pull the seat assembly up to ensure that it is locked in place.
4. Unfold the back. Refer to 5.7 Using the Folding Back Assembly, page 29.
5. Connect the joystick. Refer to Disconnecting/Connecting the Joysticks, page 35.

5.7 Using the Folding Back Assembly

SEAT IN UPRIGHT POSITION

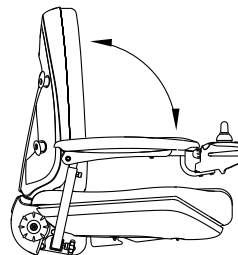

SEAT IN FOLDED POSITION

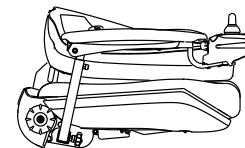

- To fold the back assembly down, perform the following:
 1. Hold both sides of the back and pull up.
 2. Push the back forward towards the seat, while maintaining upward tension on back.
- To unfold the back assembly, perform the following:

1. Holding both sides of the back, and while lifting up, rotate the back assembly into the upright position.
2. Lower the back assembly down, ensuring the back engages the locking pins and will not fold if pushed forward.

5.8 Transporting the Personal Transporter

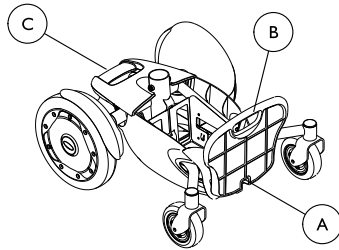

1. Remove the occupant from the personal transporter.
2. If installed, remove any accessories from the personal transporter.
3. Remove the seat. Refer to 5.6 Removing/Installing the Seat Assembly, page 29
4. Remove the batteries from personal transporter. Refer to 5.5 Removing/Installing the Battery Box From/Into the Personal Transporter, page 28.
5. Fold the footboard up against the front of the personal transporter.
6. Bend your knees and keep your back straight.
7. Using the footboard hand hold and the base handle located at the rear of the personal transporter, lift the personal transporter off of the ground and transfer the personal transporter into the vehicle.

8. Transfer seat assembly, battery box and accessories into the vehicle.
9. After reaching the destination, reverse STEPS 2 -7 to reassemble the personal transporter.

5.9 Charging Batteries



WARNING!

- NEVER attempt to recharge the batteries by attaching cables directly to the battery terminals or clamps. Always use the recharging plug located on the front of the joystick.
- DO NOT sit in the personal transporter while charging the batteries.
- DO NOT attempt to recharge the batteries and operate the power personal transporter at the same time.
- During use and charging, unsealed batteries will vent hydrogen gas which is explosive in the right concentration with air.



CAUTION!

- ALWAYS charge new batteries before initial use or battery life will be reduced.



New batteries **MUST** be fully charged prior to initial use of the personal transporter. As a general rule, batteries should be recharged daily to assure the longest possible life and minimize the required charging time. Plan to recharge the batteries when it is anticipated the personal transporter will not be used for a long period of time.

The range per battery charge using recommended batteries should be approximately 5 to 9 hours of typical operation. Extensive use on inclines may substantially reduce per charge mileage.

Description and Use of Battery Chargers

The charger automatically reduces the charge from an initially high rate to a zero reading at a fully charged condition. If left unattended, the charger should automatically shut-off when full charge is obtained or enter a trickle charge mode to maintain the batteries depending on charger model.

There are some basic concepts which will help you understand this automatic process. They are:

Once the charger has been connected to the personal transporter and wall outlet and, if necessary, the charger has been turned on, the battery charger indicator lights will flash and light to show the battery charger status and condition of batteries to be charged. Refer to owner's manual shipped with battery charger.



WARNING!

– NEVER leave the charger unattended when the breaker has tripped. A fault condition exists. Unplug and discontinue using immediately. Contact an Invacare dealer.



If performing the charging procedures, READ and CAREFULLY follow the individual instructions for each charger (supplied or purchased).

If charging instructions are not supplied, consult a qualified service technician for proper procedures.

TOOL	QUANTITY	COMMENTS
Battery Charger	1	Supplied

Front View of Joystick

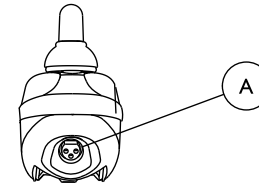

1. Attach the battery charger connector to the charger port [Ⓐ] on the joystick.
2. Plug the charger's AC power cord, or extension, into the grounded 120 VAC wall outlet.
3. Wait until charging is complete.



Allow eight hours for normal charging. Larger batteries (greater than 55 ampere-hours) or severely discharged batteries may require up to sixteen hours to be properly charged and equalized.

It is advantageous to recharge frequently rather than only when necessary. In fact, a battery's life is extended if the charge level is maintained well above a low condition.

If the batteries need to be charged more often or take longer to charge than normal, they may need to be replaced. Contact an Invacare dealer for service.

6 Setup and Maintenance

6.1 Preparing the Personal Transporter for Use

 Setup of the personal transporter should be performed by dealer at time of delivery.

Perform the following checklist to prepare the personal transporter for use.

- Check all parts for shipping damage. In case of damage, DO NOT use.
- Install the seat onto the personal transporter base.
- Install the Joystick.
- As necessary, adjust the seat assembly height, seat pan depth, back angle and the head rest height to fit the personal transporter to the user.
- As necessary, adjust the armrest width, armrest height, arm pad depth and arm pad angle to fit the personal transporter to the user.
- As necessary, adjust the footboard depth, footboard height and footboard angle to fit the personal transporter to the user.
- Ensure Batteries are fully charged.

6.2 Setup/Delivery Inspection

 Setup/delivery inspection should be performed by dealer at time of delivery/set up.

Initial adjustments should be made to suit your personal body structure needs and preference. Thereafter weekly, monthly and periodic inspections should be performed by user/attendant between the six month service inspections. Refer to 6.3 User/Attendant Inspection Checklists, page 33.

Every six months, and as necessary, take your personal transporter to a qualified technician for a thorough inspection and servicing. Refer to 6.4 Service Inspection, page 33.

- Ensure personal transporter rolls straight (no excessive drag or pull to one side).
- Ensure adjustable height arms operate.
- Ensure drive wheel mounting hardware is properly secure.
- Ensure caster wheels are free of debris, and all mounting hardware is secure and not damaged/missing.
- Check that cables are routed and secured properly to ensure that cables do NOT become entangled and damaged during normal operation of seating system.
- Ensure proper operation of powered drive functions.

6.3 User/Attendant Inspection Checklists



Every six months, and as necessary, take your personal transporter to a qualified technician for a thorough inspection and servicing. Refer to 6.4 Service Inspection, page 33.

Weekly, monthly and periodic inspections should be performed by user/attendant between the six month service inspections.

Regular cleaning will reveal loose or worn parts and enhance the smooth operation of your personal transporter. To operate properly and safely, your personal transporter must be cared for just like any other vehicle. Routine maintenance will extend the life and efficiency of your personal transporter.



CAUTION!

– As with any vehicle, the wheels and tires should be checked periodically for cracks and wear, and should be replaced.

Inspect/Adjust Weekly

- Ensure that the casters are free of debris.
- Inspect tires for flat spots and wear.
- Inspect all fasteners.
- Ensure proper operation of powered drive functions.

Inspect/Adjust Monthly

- Clean upholstery and armrests.
- Clean dirt and lint from axles.
- Clean dirt and lint from bearings.
- Ensure that the casters are free of debris.

- Inspect seat positioning strap for any signs of wear. Ensure buckle latches. Verify hardware that attaches strap to frame is secure and undamaged. Replace if necessary.

Inspect/Adjust Periodically

- Ensure personal transporter rolls straight (no excessive drag or pull to one side).
- Inspect all fasteners.
- Ensure upholstery does not have any rips or tears.
- Ensure that the casters are free of debris.
- Check that all labels are present and legible. Replace if necessary.

6.4 Service Inspection



Every six months take your personal transporter to a qualified technician for a thorough inspection and servicing.

Service inspections **MUST** be performed by a qualified technician.



WARNING!

– After ANY adjustments, repair or service and before use, make sure that all attaching hardware is tightened securely - otherwise injury or damage may result.



CAUTION!

– As with any vehicle, the wheels and tires should be checked periodically for cracks and wear, and should be replaced.

The following are recommended items to inspect during regular service inspections performed by a qualified technician. Actual items to be inspected during the service inspection may vary according to the specific personal transporter:

- Clean upholstery and armrests.
- Clean dirt and lint from axles.
- Clean dirt and lint from bearings.
- Check that all labels are present and legible. Replace if necessary.
- Ensure upholstery does not have any rips or tears.
- Inspect seat positioning strap for any signs of wear. Ensure buckle latches. Verify hardware that attaches strap to frame is secure and undamaged. Replace if necessary.
- Ensure personal transporter rolls straight (no excessive drag or pull to one side).
- Ensure that there is no excessive side movement or binding when drive wheels are lifted and spun when disengaged (free-wheeling).
- Ensure drive wheel mounting hardware is properly secure.
- Inspect tires for flat spots and wear.
- Ensure that the casters are free of debris.
- Ensure wheels/casters have proper tension when wheels/casters are spun (when free-wheeling). Wheels/casters should come to a gradual stop.
- Loosen/tighten caster locknut if wheel wobbles noticeably or binds to a stop.
- Ensure all caster/wheel/fork/headtube fasteners are secure and not damaged/missing.
- Check that cables are routed and secured properly to ensure that cables do NOT become entangled and damaged during normal operation of seating system.
- Ensure proper operation of powered functions (drive, seating, legrests, ect...).
- Inspect electrical components for signs of corrosion. Replace if corroded or damaged.
- Inspect battery terminals for loose cable connection. Tighten if necessary.
- Inspect all fasteners.

6.5 Joystick

Installing the Joystick

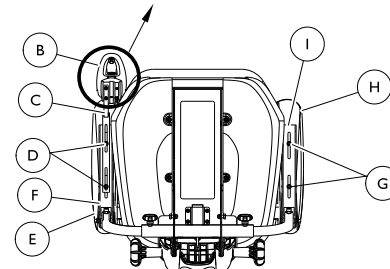
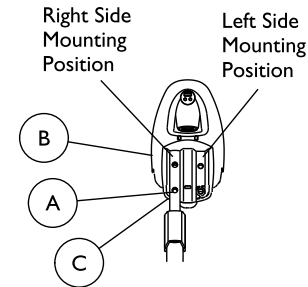

TIE WRAP LOCATIONS

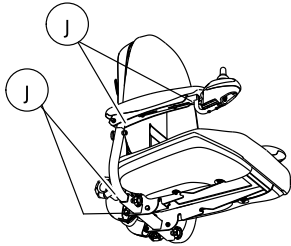

i The personal transporter is shipped with the joystick mounting hardware ready to install the joystick on the right side of the personal transporter.

Joystick is shown mounted to the right side armrest assembly.

- I. If necessary, perform the following to mount the joystick to the left side of the personal transporter:
 - a. Remove the two mounting screws **A** securing the joystick **B** to the joystick mount **C**.
 - b. Reposition the joystick to the left side position.
 - c. Using the two mounting screws, secure the joystick to the joystick mount.

i Note the position and orientation of the armrest pad before removing the two mounting screws securing the armrest assembly..

 - d. Remove the two long mounting screws **D** securing the right armrest pad **E** to the right side armrest assembly **F**.

- e. Remove the two mounting screws securing the left armrest pad to the left side armrest assembly.
 - f. Using the two mounting screws **G**, secure the right armrest pad **H** to the right armrest assembly **I**.
 - g. Proceed to STEP 3.
2. Remove, the two long mounting screws used to secure the right armrest pad to the right side armrest assembly.
 3. Position the joystick mount under the armrest assembly.
 4. Using the two long mounting screws, secure the joystick mount to the armrest assembly and armrest pad. Hand tighten the mounting screws.
 5. Move the joystick mount forward or backward to achieve the desired position.
 6. Securely tighten the two long mounting screws.
 7. Connect the joystick cable.
 8. Using tie wraps **J**, secure the joystick cable to the armrest assembly as shown, ensuring there is enough slack in the joystick cable to allow the armrest to flip back.

Disconnecting/Connecting the Joysticks

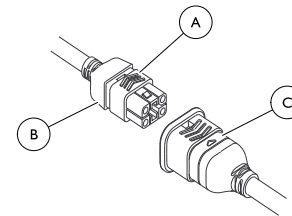

i The joystick connector is located at the rear of the seat frame.

Disconnecting

1. Hold the light grey collar (A) portion of the joystick connector (B) with one hand and the controller connector (C) on the personal transporter in the other and disconnect them by pulling them apart.

Connecting



CAUTION!

– The joystick connector and controller connector fit together in one way only. DO NOT force them together. Otherwise, damage will occur.

1. Hold the light grey collar portion of the joystick connector with one hand and the controller connector on the personal transporter in the other and align them.
2. Lightly push to engage the joystick connector and the controller connector.

Adjusting the Joystick Depth

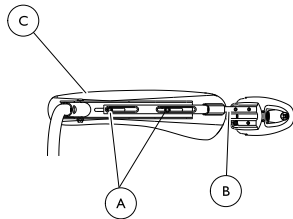

The same mounting screws used to secure the joystick mount to the armrest assembly are also used to secure the arm pad to the armrest assembly.

1. Loosen, but do not remove, the two mounting screws (A) used to secure the joystick mount (B) to the armrest assembly (C).
2. Move the joystick mount forward or backward to achieve the desired position.
3. Securely tighten the two mounting screws.

6.6 Seat and Back

Adjusting the Seat Assembly Height

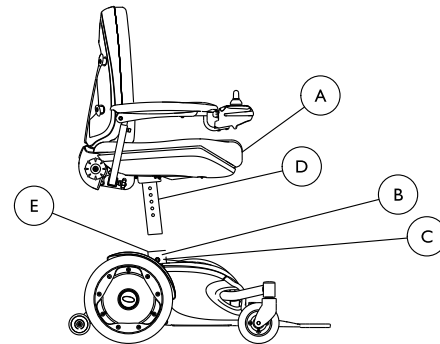



1. Remove the seat assembly (A). Refer to 5.6 Removing/Installing the Seat Assembly, page 29.
2. Remove the mounting screw (B) and locknut (C) that secures the seat post (D) to the support tube (E).
3. Adjust the seat post to one of five mounting positions.
4. Reinstall mounting screw and locknut. Torque 40 ft/lbs ± 10%.
5. Reinstall the seat assembly. Refer to 5.6 Removing/Installing the Seat Assembly, page 29.

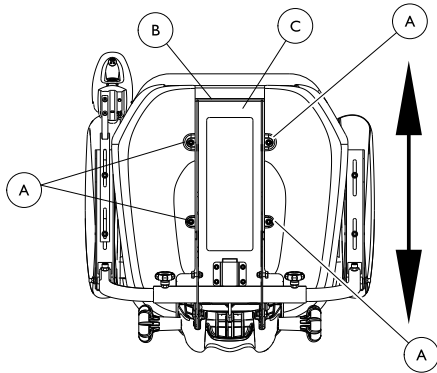

The seat height adjustment is between 19 to 23 inches in 1 inch increments

Seat Pan Depth



 The seat pan depth adjustment is between 17 to 20 inches.

1. Loosen but do not remove the four locknuts **A** securing the seat pan **B** to the seat mounting bracket **C**.
2. Move the seat pan forward or backward to desired position.
3. Securely tighten the four locknuts.

Back Angle Adjustment

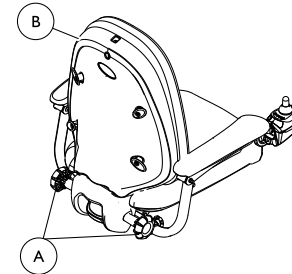

- I. Perform one of the following to adjust the back angle:

- Lowering the Back - Rotate back angle adjustment knobs **A** at the base of the back **B** towards the front of the personal transporter.
- Raising the Back - Rotate back angle adjustment knobs at the base of the back towards the rear of the personal transporter.

Adjusting the Headrest Height

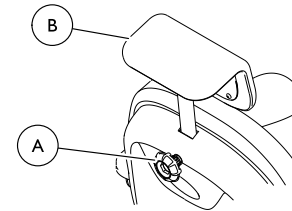

1. Loosen the headrest knob (A).
2. Raise or lower the headrest (B) to align the headrest knob with one of six mounting positions.
3. Tighten the headrest knob.

6.7 Armrest Assemblies

Adjusting Arm Width

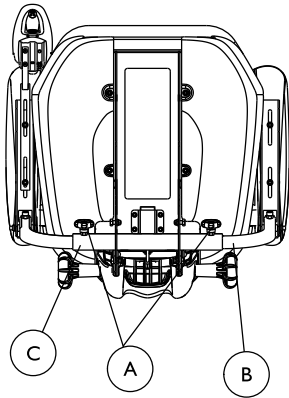

i Both armrest should be adjusted to the same distance away from the arm support tube.

It is recommended to keep armrests adjusted as narrow as possible for improved maneuverability.

1. Loosen the two lock knobs that secure the armrest assemblies to the arm support tubes.
2. Reposition armrest to align the lock knobs with one of the mounting positions.
3. Securely tighten the two adjustment knobs that secure the armrest assembly to the arm support tube.

Adjusting the Arm Height

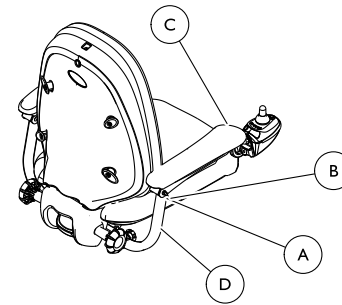

i Armrest height adjustment holes are in 1 inch increments

1. Remove the mounting screw (A) and locknut (B) securing the armrest assembly (C) to the arm tube (D).
2. Adjust the armrest to one of four height adjustment holes.
3. Using the mounting screw and locknut, secure the armrest assembly to the arm tube.
4. Repeat STEPS 1 – 3 to adjust the height of the opposite armrest.

Adjusting the Arm Pad Depth

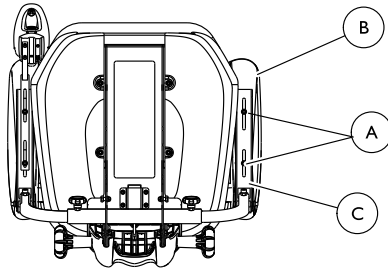

i Armrest with Joystick: The same mounting screws used to secure the joystick mount to the armrest assembly are also used to secure the arm pad to the armrest assembly.

1. Loosen but do not remove the two mounting screws **A** securing the armrest pad **B** to the arm assembly **C**.
2. Move the armrest pad forward or backward to achieve the desired position.
3. Securely tighten the two mounting screws securing the armrest pad to the arm assembly.
4. Repeat STEPS 1-3 to reposition the opposite armrest pad.

Adjusting the Armrest Pad Angle (Left or Right)

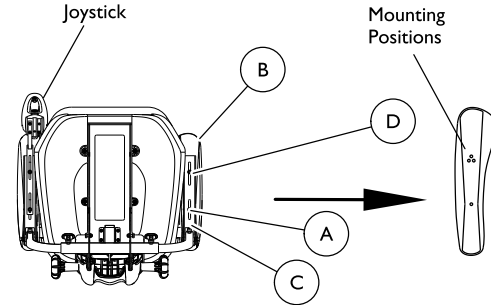

i Armrest with Joystick: The same mounting screws used to secure the joystick mount to the armrest assembly are also used to secure the arm pad to the armrest assembly.

1. Loosen but do not remove the rear mounting screw **A** securing the arm pad **B** to the armrest assembly **C**.
2. Remove the front mounting screw **D** securing the arm pad to the armrest assembly.
3. Shift the arm pad to the right or left to one of three mounting positions.
4. Using the front mounting screw, secure the arm pad to the armrest assembly.

i Adjusting the armrest pad angle may change the armrest pad depth. If necessary, adjust the armrest pad depth. Refer to Adjusting the Arm Pad Depth, page 39.

5. Repeat STEPS 1-4 to reposition the opposite arm pad.

Adjusting the Armpad Angle (Up or Down)

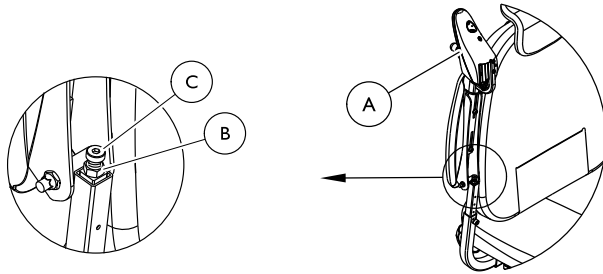

1. Raise the armrest assembly vertically as shown.
2. Loosen the locknut on the angle adjustment screw.
3. Perform one of the following:
 - Turn the angle adjustment screw clockwise to lower the armrest angle.
 - Turn the angle adjustment screw counterclockwise to raise the armrest angle.
4. Tighten the locknut on the angle adjustment screw.
5. Lower the armrest to the horizontal position.

6.8 Footboard



WARNING!

- After ANY adjustments, repair or service and before use, make sure that all attaching hardware is tightened securely - otherwise injury or damage may result.
- Before performing any maintenance, adjustment or service, verify that ON/OFF switch on the joystick is in the OFF position.
- DO NOT stand on the flip-up footboard. When getting in or out of the personal transporter, make sure that the flip-up footboard is in the upward position.
- Limited Clearance Between Footboard and Caster - The user's feet must remain on the footboard while operating the personal transporter. If the user's feet are allowed to rest off the side of the footboard they may come in contact with the caster possibly resulting in injury.

Removing/Installing the Footboard or Adjusting the Footboard Depth

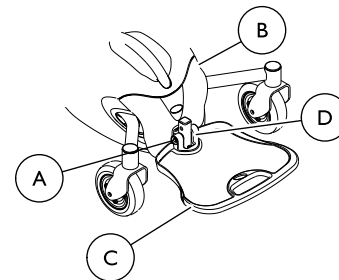

1. Remove the battery box. Refer to 5.5 Removing/Installing the Battery Box From/Into the Personal Transporter, page 28.
2. Remove the hex head screw locknut (A), located on the underside of the personal transporter base frame (B), that secures the footboard (C) to the footboard tube (D).
3. Remove the footboard from the footboard tube.

 If adjusting the footboard depth is necessary, align one of three mounting holes in the footboard assembly with the mounting hole in the footboard tube.

4. Reverse STEPS 1-2 to install/adjust the depth of the footboard assembly.

Adjusting the Footboard Height

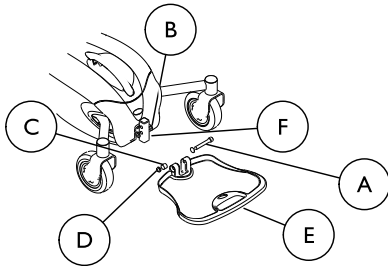

1. Remove the socket head screw (A), three washers (B), spacer (C) and locknut (D) that secures the footboard (E) to the footboard support (F).
2. Remove the footboard from the footboard support.
3. Position the footboard onto the footboard support so that the mounting holes in the personal transporter frame align with the desired mounting holes in the footboard support.
4. Using the socket heat screw, three washers, spacer and locknut secure the footboard to the footboard support.

Adjusting the Footboard Angle

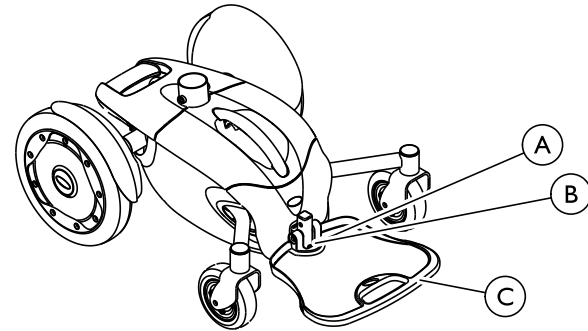

1. Loosen the jam nut (A) and set screw (B) located on the rear of the footboard (C).
2. Adjust the set screw in or out to obtain the desired footboard angle.
3. Thread the jam nut until it is flush with the footboard bracket.
4. Securely tighten the jam nut against the footboard to secure the set screw in place.

6.9 Cushion Covers

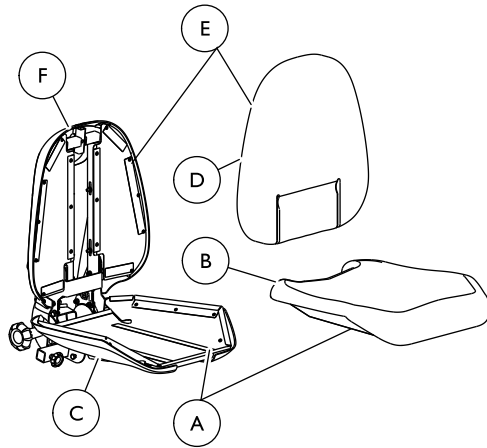

Removing/Installing the Seat Cushion Cover

1. Pulling up to release the hook and loop strips (A), remove the seat cushion (B) to the seat pan (C).
2. Open the fold along the bottom of the seat cushion.
3. Remove the seat cushion cover from the seat cushion.
4. Reverse STEPS 1-3 to reinstall the seat cushion cover.

Removing/Installing the Back Cushion Cover

1. Pulling the back cushion (D) towards the front of the personal transporter to release the hook and loop strips (E), remove the back cushion from the back pan (F).
2. Open the fold along the bottom of the back cushion.
3. Remove the back cushion cover from the back cushion
4. Reverse STEPS 1-4 to reinstall the back cushion cover.

Cleaning the Cushion Covers



CAUTION!

- Machine wash cold. Gentle cycle. Mild detergent. No fabric softeners or bleach.
- DO NOT machine dry. Air dry ONLY out of sun.

6.10 Adjusting Forks

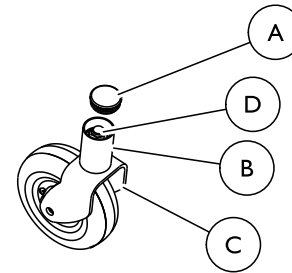

This procedure must be performed by a qualified technician.
This procedure applies to both Forks.

1. Remove the head tube cover (A) from the caster head tube (B).
2. To properly tighten caster journal system and guard against flutter, perform the following check:
 - a. Tip the personal transporter forward, toward the floor.
 - b. Pivot both forks (C) and casters to top of their arc simultaneously.
 - c. Let casters drop to bottom of arc (wheels should swing once to one-side, then immediately rest in a straight downward position).
 - d. Adjust locknuts (D) according to freedom of caster swing.

3. Test personal transporter for maneuverability.
4. Readjust locknuts if necessary, and repeat STEPS 1-3 until correct.
5. Snap head tube cover into the caster head tube.

6.11 Batteries



WARNING!

- Invacare strongly recommends that battery installation and battery replacement always be done by a qualified technician.
- The use of rubber gloves is recommended when working with batteries.
- After ANY adjustments, repair or service and before use, make sure all attaching hardware is tightened securely - otherwise injury or damage may result.
- 17AH batteries weigh 15 pounds each. Use proper lifting techniques (lift with your legs) to avoid injury.
- DO NOT remove the circuit breaker from the wiring assembly.
- Unless otherwise indicated, make sure power to the personal transporter is OFF before performing these procedures.
- DO NOT tip the batteries. Keep the batteries in an upright position.
- ALWAYS use a battery handle/lifting strap when lifting a battery. It is the most convenient method and assures that the battery acid will not spill.
- When tightening the clamps, always use a box wrench. Pliers will “round off” the nuts. NEVER wiggle the battery terminal(s)/post(s) when tightening. The battery may become damaged.



WARNING!

- NEVER allow any of your tools and/or battery cable(s) to contact BOTH battery post(s) at the same time. An electrical short may occur and serious personal injury or damage may occur.
- The POSITIVE (+) RED battery cable MUST connect to the POSITIVE (+) battery terminal(s)/post(s), otherwise serious damage will occur to the electrical system.



If there is battery acid in the bottom of the battery box or on the sides of the battery(ies), apply baking soda to these areas to neutralize the battery acid. Before reinstalling the existing or new battery(ies), clean the baking soda from the battery tray or battery(ies) being sure to avoid contact with skin and eyes. Determine source of contamination. NEVER install/reinstall a battery with a cracked or otherwise damaged case.

Using the Proper Batteries



WARNING!

- Use 17AH batteries only. Batteries with terminal configuration (positive on the left and negative on the right) as shown below MUST be used. Batteries that have the reverse terminal configuration MUST not be used - otherwise injury and damage may occur.
- Terminals must have a cross hole in them as shown below in Detail “A”.

1. Position battery on ground/flat surface as shown below.
2. Visually inspect the battery to ensure proper polarity:

PROPER BATTERY TERMINAL CONFIGURATION TO USE

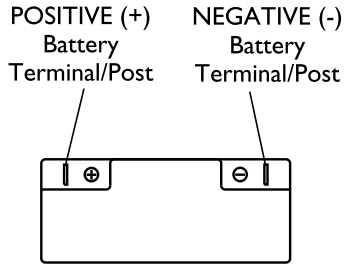

DO NOT USE THIS TYPE OF BATTERY TERMINAL CONFIGURATION

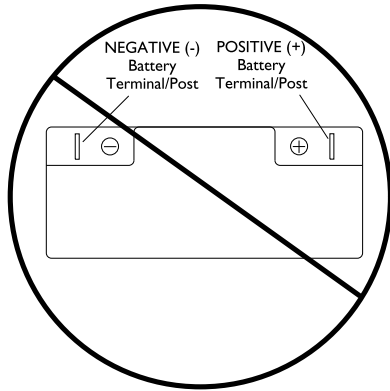

DETAIL "A"

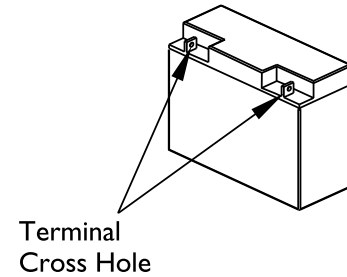

Replacing the Batteries

TOOL	QTY	COMMENTS
5/16-inch (6pt) Box Wrench	1	Not Supplied
Diagonal Cutters	1	Not Supplied

Disconnecting/Connecting the Battery Cables

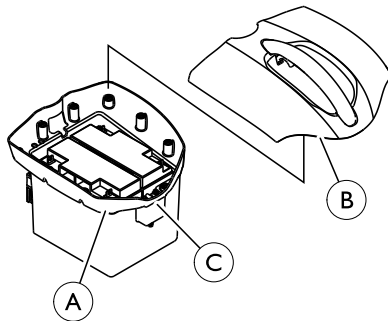
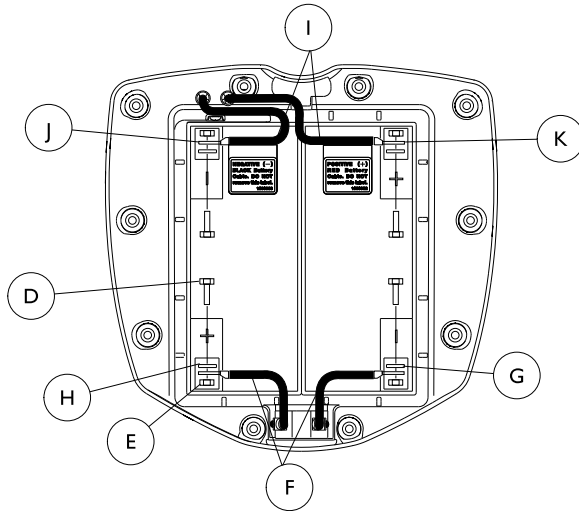

WARNING!

- The use of rubber gloves is recommended when working with batteries.
- NEVER allow any of your tools and/or battery cables to contact both battery terminals at the same time. An electrical short may occur and serious personal injury or damage may occur.
- The positive (+) battery cable must connect to the positive (+) battery terminal, otherwise serious damage will occur to the electrical system.
- Proper battery terminal configuration **MUST** be used. Refer to Using the Proper Batteries, page 43. Batteries that have the terminal configuration reversed **MUST NOT** be used - otherwise serious injury or damage may occur.

1. Remove the battery box from the personal transporter. Refer to 5.5 Removing/Installing the Battery Box From/Into the Personal Transporter, page 28
2. Remove the 10 mounting screws (A) securing the battery box cover (B) the battery box (C).
3. Remove the two hex head mounting screws (D) and locknuts (E) securing the circuit breaker wiring harness (F) to the negative terminal (G) of the left side battery and the positive battery terminal (H) of the right side battery.
4. Perform the following to disconnect the battery connector wiring harness (I) from the two batteries:
 - a. Remove the hex head mounting screw and nut securing the BLACK negative battery cable (I) from the negative terminal of the left side battery.
 - b. Remove the hex head mounting screw and nut securing the RED positive battery cable (K) from the positive battery terminal of the right side battery.

5. Remove the two batteries from the battery box.
6. Reverse STEPS 1 - 4 to install the new batteries. Refer to 5.5 Removing/Installing the Battery Box From/Into the Personal Transporter, page 28.

 New batteries **MUST** be fully charged before using, otherwise the life of the batteries will be reduced.

7. If necessary, charge the batteries.

Cleaning Battery Terminals



WARNING!

– Most batteries are not sold with instructions. However, warnings are frequently noted on the cell caps. Read them carefully.



WARNING!

– **DO NOT** allow the liquid in the battery to come in contact with skin, clothes or other possessions. The liquid is acidic and harmful or damaging burns may result. Should the liquid touch your skin, wash the area **IMMEDIATELY** and thoroughly with cool water. In serious cases or if eye contact is made, seek medical attention **IMMEDIATELY**.

1. Examine battery terminals for corrosion.
2. Clean terminals by using a battery cleaning tool, wire brush, or medium grade sand paper.

 Upon completion, areas should be shiny, not dull.

3. Carefully dust off all metal particles.

Resetting the Circuit Breaker

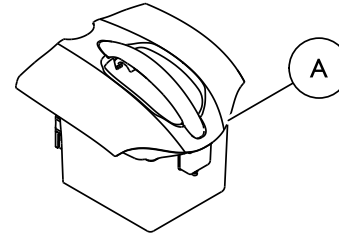

WARNING!

– **NEVER** defeat or bypass the circuit breaker. Only replace with a circuit breaker of the same rating.

1. Remove the battery box from the personal transporter base. Refer to 5.5 Removing/Installing the Battery Box From/Into the Personal Transporter, page 28.
2. To reset - press the circuit breaker reset button located on the front of the battery box.
3. Reinstall the battery box. Refer to 5.5 Removing/Installing the Battery Box From/Into the Personal Transporter, page 28.

7 Troubleshooting

7.1 Driving Performance

PERSONAL TRANSPORTER VEERS LEFT/RIGHT	SLUGGISH TURN AND/OR PERFORMANCE	CASTERS FLUTTER	SQUEAKS AND RATTLES	LOOSENESS IN PERSONAL TRANSPORTER	PERSONAL TRANSPORTER 3 WHEELS	SOLUTIONS
X	X	X				Check for loose stem nuts/bolts, bearings or signs of wear.
X		X	X	X	X	Check for uneven tire wear, bent fork/frame or loose hardware.
X	X	X		X	X	If pneumatic, check tires for correct and equal pressure.

7.2 Electrical



For additional troubleshooting information and explanation of error codes, refer to the individual Electronics Manual supplied with each personal transporter.

Information Gauge Diagnostics

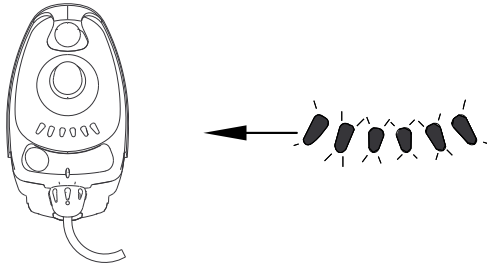

The joystick information gauge acts as a service indicator to give indications of the type of fault or error detected by the control module. When a fault is detected, the personal transporter may stop and not drive. The LEDs on the information gauge will flash rapidly. The number of flashes indicates the nature of the error. If multiple errors are found, only the first error encountered by the control module will be displayed.

NUMBER OF FLASHES	ERROR CODE DESCRIPTION	POSSIBLE SOLUTION
1	User Fault	Release joystick to neutral and try again.
2	Battery Fault	Charge the batteries.
3	Left Motor Fault	Contact Invacare/Dealer for service.
4	Right Motor Fault	Contact Invacare/Dealer for service.
5	Left Park Brake Fault	Ensure brake lever is in the drive position before turning on the personal transporter. Ensure motor cable is plugged into the controller. Contact Invacare/Dealer for service.
6	Right Park Brake Fault	Ensure brake lever is in the drive position before turning on the personal transporter. Ensure motor cable is plugged into the controller. Contact Invacare/Dealer for service.

7	Remote Fault	Check to make sure joystick is connected properly. Turn Joystick off then on. Contact Invacare/Dealer for service.
8	Controller Fault	Contact Invacare/Dealer for service.
9	Communications Fault	Check joystick cable connections. Check joystick cable and connectors for damage. Contact Invacare/Dealer for service.
10	General Fault	Contact Invacare/Dealer for service.
11	Incompatible or incorrect Remote	Wrong type of remote connected. Contact Invacare/Dealer for service.

7.3 Checking Battery Charge Level

The following “Dos” and “Don’ts” are provided for your convenience and safety.

DON'T	DO
Don't perform any installation or maintenance without first reading this manual.	Read and understand this manual and any service information that accompanies a battery and charger before operating the personal transporter.
Don't perform installation or maintenance of batteries in an area that could be damaged by battery spills.	Move the personal transporter to a work area before cleaning terminals, or opening battery box.
Don't make it a habit to discharge batteries to the lowest level.	Recharge as frequently as possible to maintain a high charge level and extend battery life.
Don't use chargers or batteries that are not appropriate for the chair.	Follow recommendations in this manual when selecting a battery or charger.
Don't put new batteries into service before charging.	Fully charge a new battery before using.
Don't tip or tilt batteries.	Use a carrying strap to remove, move or install a battery.
Don't tap on clamps and terminals with tools.	Push battery clamps on the terminals. Spread clamps wider if necessary.
Don't mismatch your battery and chargers.	Use only a AGM charger for a AGM battery.

7.4 Usability Survey

Please complete the survey below to evaluate this manual.
Your participation in the evaluation assists in the development of effective and usable manuals for our customers.

The survey is also available online:
<http://www.invacare.com/TechnicalDocumentSurvey>



Yes, you can!

1. Please indicate your primary involvement with the product (choose one):

- | | |
|---|--|
| <input type="checkbox"/> Product User/Owner | <input type="checkbox"/> Product Service Technician |
| <input type="checkbox"/> User Assistant | <input type="checkbox"/> Health Care Provider |
| <input type="checkbox"/> Product Dealer | <input type="checkbox"/> Other (please specify): _____ |

2. Please indicate which product manual you are evaluating:

3. Evaluate the content:

	YES	NO
After reading this document, do you have a better understanding of how to use the product?	<input type="checkbox"/>	<input type="checkbox"/>
Do you have a better understanding of any limitations on the use of this product?	<input type="checkbox"/>	<input type="checkbox"/>
Is there any irrelevant information?	<input type="checkbox"/>	<input type="checkbox"/>
Is the Table of Contents useful?	<input type="checkbox"/>	<input type="checkbox"/>
Does any information seem inaccurate/misleading?	<input type="checkbox"/>	<input type="checkbox"/>
Do you understand that misuse of the product can cause injury or damage?	<input type="checkbox"/>	<input type="checkbox"/>

Explain:

4. Evaluate the Warnings/Cautions:

	YES	NO
Are there any warnings/cautions that you do not understand?	<input type="checkbox"/>	<input type="checkbox"/>
Are there too many warnings/cautions?	<input type="checkbox"/>	<input type="checkbox"/>
Are there warnings/cautions that you feel do not apply to this product?	<input type="checkbox"/>	<input type="checkbox"/>

Explain:

5. Evaluate the style:

	YES	NO
Is anything hard to locate/follow?	<input type="checkbox"/>	<input type="checkbox"/>
Are any headings missing/confusing?	<input type="checkbox"/>	<input type="checkbox"/>
Are there too many headings?	<input type="checkbox"/>	<input type="checkbox"/>
Should any material be a bulleted list or checklist instead of numbered steps or a paragraph?	<input type="checkbox"/>	<input type="checkbox"/>
Is there material that might be clarified by a visual?	<input type="checkbox"/>	<input type="checkbox"/>

Explain:

6. Evaluate the illustrations:

	YES	NO
Are the illustrations useful?	<input type="checkbox"/>	<input type="checkbox"/>
Do the illustrations need more or less detail?	<input type="checkbox"/>	<input type="checkbox"/>
Is the number/size of illustrations adequate?	<input type="checkbox"/>	<input type="checkbox"/>

Explain:

7. Do you have suggestions for other ways of making this document easier to use?

Explain:	YES	NO
_____	<input type="checkbox"/>	<input type="checkbox"/>
_____	<input type="checkbox"/>	<input type="checkbox"/>

Thank You! Thank you for completing this survey. If you have any questions or we may be of assistance to you, please feel free to contact us.

Send your survey to Invacare Technical Writing Department: TechnicalWriting@invacare.com
or Invacare Corporation: One Invacare Way, Elyria, Ohio 44035 FAX: 440-329-6975

Notes

USA One Invacare Way, Elyria, Ohio USA, 44036-2125, 800-333-6900

Canada 570 Matheson Blvd E Unit 8, Mississauga Ontario, L4Z 4G4 Canada, 800-668-5324

www.invacare.com

1171794-B 2012-10-3



Making Life's Experiences Possible™

Download from www.somanuals.com. All Manuals Search And Download.



Yes, you can.®

Free Manuals Download Website

<http://myh66.com>

<http://usermanuals.us>

<http://www.somanuals.com>

<http://www.4manuals.cc>

<http://www.manual-lib.com>

<http://www.404manual.com>

<http://www.luxmanual.com>

<http://aubethermostatmanual.com>

Golf course search by state

<http://golfingnear.com>

Email search by domain

<http://emailbydomain.com>

Auto manuals search

<http://auto.somanuals.com>

TV manuals search

<http://tv.somanuals.com>