

Operator's Manual

Platinum™ Series XL, 5, 10

Oxygen Concentrators Standard,
with SensO₂® and HomeFill®

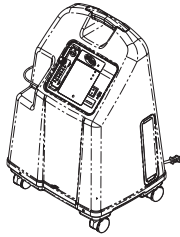

Invacare 5 with SensO₂
Model IRC5LXO2

Invacare 5
Model IRC5LX

Invacare 10 with SensO₂
Model IRC10LXO2

Invacare 10
Model IRC10LX

Dealer: This manual MUST be given to the end user.

User: Before using this product, read this manual and save for future reference.

**For more information regarding
Invacare products, parts, and services,
please visit www.invacare.com**



Yes, you can.®

 WARNING

DO NOT use this product or any available optional equipment without first completely reading and understanding these instructions and any additional instructional material such as owner's manuals, service manuals or instruction sheets supplied with this product or optional equipment. If you are unable to understand the warnings, cautions or instructions, contact a healthcare professional, dealer or technical personnel before attempting to use this equipment - otherwise, injury or damage may occur.

 ACCESSORIES WARNING

Invacare products are specifically designed and manufactured for use in conjunction with Invacare accessories. Accessories designed by other manufacturers have not been tested by Invacare and are not recommended for use with Invacare products.

ACCESSORIES

There are many different types of humidifiers, oxygen tubing, cannulas and masks that can be used with this device. You should contact your local home care provider for recommendations on which of these devices will be best for you. They should also give you advice on the proper usage, maintenance, and cleaning.

TABLE OF CONTENTS

ACCESSORIES 2

REGISTER YOUR PRODUCT 4

SPECIAL NOTES 5

LABEL LOCATION 7

SECTION 1—GENERAL GUIDELINES 8

 To Reduce the Risk of Burns, Electrocutation, Fire or
 Injury to Persons 8

 Operating Information 9

 Radio Frequency Interference 9

SECTION 2—FEATURES 11

SECTION 3—HANDLING 12

 Unpacking..... 12

 Inspection 12

 Storage 12

**SECTION 4—TYPICAL PRODUCT
PARAMETERS 13**

SECTION 5—OPERATING INSTRUCTIONS 16

 Introduction..... 16

 Select a Location 16

 Set-Up 17

 Plug in Power Cord..... 17

 Connect Humidifier (If So Prescribed) 17

 Power Switch 19

 Flowrate..... 20

 Front Panel Indicators - Units with SensO2 21

 Initial Startup of the Concentrator..... 21

 Front Panel Indicators - Units without SensO2 22

 Initial Startup of the Concentrator..... 22

TABLE OF CONTENTS

SECTION 6—MAINTENANCE 23

 Routine Maintenance..... 23

 Cleaning the Cabinet Filter..... 23

 Cleaning the Cabinet 24

 Cleaning the Humidifier 24

SECTION 7—TROUBLESHOOTING GUIDE 26

NOTES 28

LIMITED WARRANTY 30

REGISTER YOUR PRODUCT

The benefits of registering include:

1. Safeguarding your investment.
2. Ensuring long-term maintenance and servicing of your product.
3. Receiving updates with product information, maintenance tips and industry news.

**Register ONLINE at
warranty.invacare.com**

Please have your model number and purchase date available to complete your registration.

Any registration information you submit will only be used by Invacare Corporation and protected as required by applicable laws and regulations.

SPECIAL NOTES

Signal words are used in this manual and apply to hazards or unsafe practices which could result in personal injury or property damage. Refer to the following table for definitions of the signal words.

SIGNAL WORD	MEANING
DANGER	Danger indicates an imminently hazardous situation which, if not avoided, will result in death or serious injury.
WARNING	Warning indicates a potentially hazardous situation which, if not avoided, could result in death or serious injury.
CAUTION	Caution indicates a potentially hazardous situation which, if not avoided, may result in property damage or minor injury or both.

NOTICE

The information contained in this document is subject to change without notice.

DANGER

DO NOT SMOKE while using this device. Keep all matches, lighted cigarettes or other sources of ignition out of the room in which this product is located and away from where oxygen is being delivered.

NO SMOKING signs should be prominently displayed. Textiles and other materials that normally would not burn are easily ignited and burn with great intensity in oxygen enriched air. Failure to observe this warning can result in severe fire, property damage and cause physical injury or death.

CAUTION

“Caution: Federal law restricts this device to sale or rental by or on order of a physician, or any other practitioner licensed by the law of the State in which he/she practices to use or order the use of this device.”

Invacare recommends an alternate source of supplemental oxygen in the event of a power outage, alarm condition or mechanical failure. Consult your physician or equipment provider for the type of reserve system required.

This equipment is to be used as an oxygen supplement and is not considered life supporting or life sustaining.

LABEL LOCATION

IRC5LX and IRC10LX

HomeFill II Compatible 

Operating Instructions
(See Operator's Manual)

Alarms **I/O** 
(See Operator's Manual)

 **WARNING - RISK OF FIRE**
NO SMOKING - Keep ALL sources of ignition out of the room in which this product is located and away from areas where oxygen is being delivered. Textiles, oils and other combustibles are easily ignited and burn with great intensity in oxygen enriched air.

 **CAUTION - RISK OF ELECTRIC SHOCK**
Do not remove cover. Refer servicing to qualified service personnel.

 Flow rates below 0.5 L/min. will trigger Low Flow Alarm (rapid audible alarm).

 Set flowmeter at 3 L/min. or less when filling HomeFill II cylinders.

CAUTION: Federal (USA) law restricts this device to sale by or on the order of a physician.

 PIN 1108820

IRC5LXO2 and IRC10LXO2

HomeFill II Compatible
with **SensO₂**™ 

Operating Instructions
(See Operator's Manual)

Alarms **O₂** 
(See Operator's Manual)

 **WARNING - RISK OF FIRE**
NO SMOKING - Keep ALL sources of ignition out of the room in which this product is located and away from areas where oxygen is being delivered. Textiles, oils and other combustibles are easily ignited and burn with great intensity in oxygen enriched air.

 **CAUTION - RISK OF ELECTRIC SHOCK**
Do not remove cover. Refer servicing to qualified service personnel.

 Flow rates below 0.5 L/min. will trigger Low Flow Alarm (rapid audible alarm).

 Set flowmeter at 3 L/min. or less when filling HomeFill II cylinders.

CAUTION: Federal (USA) law restricts this device to sale by or on the order of a physician.

 PIN 1108785

Serial Number Label is located on the resonator intake assembly

Specification Label is located on the back near the bottom

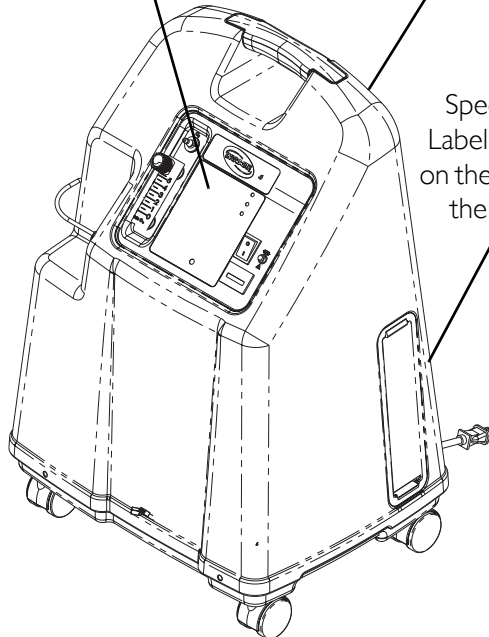

SECTION I—GENERAL GUIDELINES

In order to ensure the safe installation, assembly and operation of the Platinum concentrator these instructions **MUST** be followed.

⚠ WARNING

This section contains important information for the safe operation and use of this product.

To Reduce the Risk of Burns, Electrocutation, Fire or Injury to Persons

⚠ DANGER

Risk of electric shock. DO NOT disassemble. Refer servicing to qualified service personnel. No user serviceable parts.

Avoid using while bathing. If continuous usage is required by the physician's prescription, the concentrator **MUST be located in another room at least 7 ft from the bath.**

DO NOT come in contact with the concentrator while wet.

DO NOT place or store product where it can drop into water or other liquid.

DO NOT reach for product that has fallen into water. Unplug **IMMEDIATELY.**

If the concentrator has a damaged cord or plug, if it is not working properly, if it has been dropped or damaged, or dropped into water, call qualified technician for examination and repair.

A spontaneous and violent ignition may occur if oil, grease or greasy substances come in contact with oxygen under pressure. These substances **MUST be kept away from the oxygen concentrator, tubing and connections, and all other oxygen equipment. **DO NOT** use any lubricants unless recommended by Invacare.**

Avoid creation of any spark near medical oxygen equipment. This includes sparks from static electricity created by any type of friction.

Operating Information

For optimum performance, Invacare recommends that each concentrator be on and running for a minimum of 30 minutes at a time. Shorter periods of operation may reduce maximum product life.

Keep the oxygen tubing, cord, and unit out from under such items as blankets, bed coverings, chair cushions, clothing and away from heated or hot surfaces, including space heaters, stoves and similar electrical appliances.

DO NOT move or relocate concentrator by pulling on the power cord.

NEVER drop or insert any object or liquid into any opening. Invacare recommends that Crush-Proof oxygen tubing be used with this product and not exceed 15.2 m (50 ft) in length. There are no user serviceable parts. This does not include normal maintenance items. See maintenance section for user maintenance items.

A product should NEVER be left unattended when plugged in. Make sure the Platinum is Off when not in use.

Close supervision is necessary when this product is used near children or physically-challenged individuals.

Additional monitoring or attention may be required for patients using this device who are unable to hear or see alarms or communicate discomfort.

DO NOT connect the concentrator in parallel or series with other oxygen concentrators or oxygen therapy devices.

Radio Frequency Interference

This equipment has been tested and found to comply with EMC limits specified by IEC/EN 60601-1-2. These limits are designed to provide a reasonable protection against electromagnetic interference in a typical medical installation.

Other devices may experience interference from even the low levels of electromagnetic emissions permitted by the above standards. To determine if the emissions from the Platinum is causing the interference, turn the Platinum Off. If the interference with the other device(s) stops, then the Platinum is causing the interference. In such rare cases, interference may be reduced or corrected by one of the following measures:

- Reposition, relocate, or increase the separation between the equipment.

Connect the equipment into an outlet on a circuit different from that to which the other device(s) is connected.

SECTION 2—FEATURES

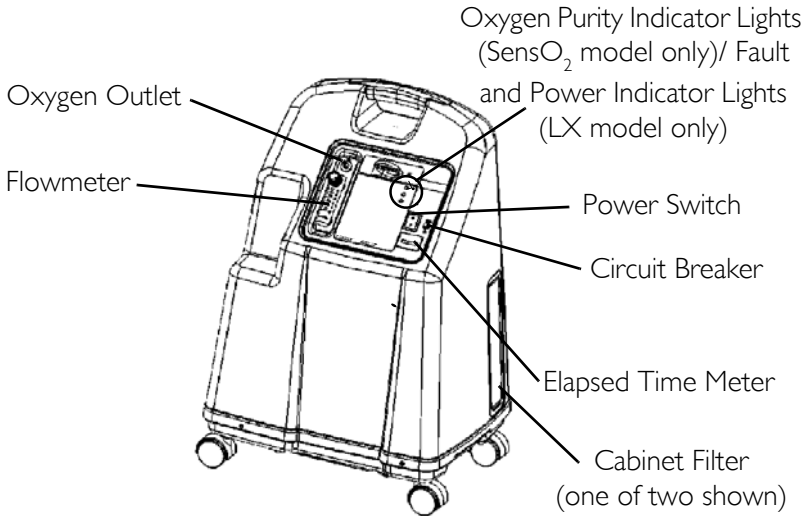

ACCESSORIES (NOT SHOWN):

Remote Humidifier/Flowmeter Accessory - IRCRF5 (Platinum 5 and XL Only)

PreciseRX™ Pediatric Humidifier/Flowmeter Accessory - IRCPF16 (Platinum 5 and XL Only)

HomeFill home oxygen compressor - IOH200

REAR VIEW

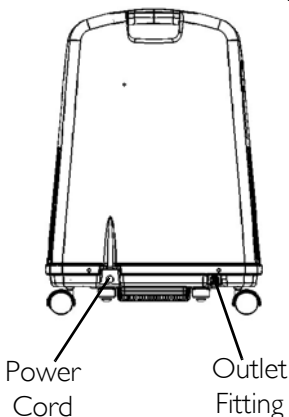

NOTE: This outlet fitting is to be used only for filling oxygen cylinders with the HomeFill home oxygen compressor. The outlet fitting does not affect concentrator performance. Refer to the HomeFill owner's manual, part number 1100873, for connection and operating instructions. When not in use, the plug provided with the concentrator should be inserted into the outlet fitting. For more information about the HomeFill, contact your Invacare dealer.

SECTION 3—HANDLING

The concentrator should ALWAYS be kept in the upright position to prevent cabinet damage while being transported.

If the concentrator is to be reshipped by common carrier, additional cartons are available from Invacare.

Unpacking

NOTE: For this procedure, refer to FIGURE 3.1.

1. Check for any obvious damage to the carton or its contents. If damage is evident, notify the carrier, or your local dealer.
2. Remove all loose packing from the carton.
3. Carefully remove all the components from the carton.

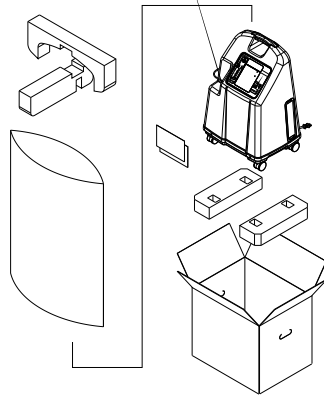

FIGURE 3.1 Unpacking

NOTE: Unless the oxygen concentrator is to be used immediately, retain containers and packing materials for storage until use of the concentrator is required.

Inspection

Inspect/examine exterior of the oxygen concentrator for nicks, dents, scratches or other damages. Inspect all components.

Storage

1. Store the repackaged oxygen concentrator in a dry area.
2. DO NOT place objects on top of repackaged concentrator.

SECTION 4—TYPICAL PRODUCT PARAMETERS

Electrical Requirements:	120 VAC \pm 10% (132 VAC/108 VAC), 60 Hz
Rated Current Input:	Platinum 5 and XL: 4.3 A
	Platinum 10: 4.7 A
Sound Level:	Platinum 5 and XL: 50 dB Average
	Platinum 10: 58 dB Average
Altitude:	Platinum 5 and XL - Up to 6,000 ft (1828 meters) above sea level without degradation of concentration levels. From 6,000 ft (1828 meters) to 13,129 ft (4000 meters) below 90% efficiency
	Platinum 10 - Up to 4,000 ft (1230 meters) above sea level without degradation of concentration levels. From 4,000 ft (1230 meters) to 13,129 ft (4000 meters) below 90% efficiency
*Oxygen Output Concentration Levels:	All 5LXO2/5LX models 87% to 95.6% for flows ranging 0.5 to 5 L/min and all 10LXO2/10LX models 87% to 95.6% for flows ranging 2 L to 10 L/min
Maximum Outlet Pressure:	Platinum 5 and XL: 5 psi \pm 0.5 psi (34.5 kPa \pm 3.45 kPa)
	Platinum 10: 9 psi \pm 0.5 psi (62.0 kPa \pm 3.45 kPa)

**NOTE: Stated concentration levels achieved after initial warm-up period (approximately 30 minutes).*

SECTION 4—TYPICAL PRODUCT PARAMETERS

Flow Range:	Platinum 5 and XL - 0.5 to 5 L/min For flowrates less than 1 L/min, we recommend the use of the Invacare Pediatric Flowmeter IRCPF16 Accessory.
	Platinum 10 - 2 L/min to 10 L/min
Low Flow Alarm:	Platinum 5 - 0 L/min to 0.5 L/min, Platinum 10 - 0 L/min to 1 L/min Rapid Audible Alarm Beeping (No Accessories Connected)
Average Power Consumption:	Platinum 5 and XL: 400W Platinum 10: 585W
Pressure Relief Mechanism Operational at:	35 psi \pm 3.5 psi (241 kPa \pm 24.1 kPa)
Change in maximum recommended flow when back pressure of 7kPa is applied:	0.7 L/min
Filters:	Cabinet (2), Outlet HEPA and Compressor Inlet.
Safety System:	Current overload or line surge shutdown. High temperature compressor shutdown. High Pressure Alarm w/compressor shutdown. Low Pressure Alarm w/compressor shutdown. Battery Free Power Loss Alarm. SensO ₂ Oxygen System (SensO ₂ Model) Low Flow Alarm.
Width:	18 3/8 in \pm 3/8 in (46.7 cm \pm 1 cm)
Height:	26 3/8 in \pm 3/8 in (67.0 cm \pm 1 cm)
Depth:	14 3/8 in \pm 3/8 in (36.5 cm \pm 1 cm)
Weight:	Platinum 5 and XL: 52 lbs \pm 2 lbs (23.6 kg \pm 1 kg)
	Platinum 10: 53 lbs \pm 2 lbs (24.0 kg \pm 1 kg)
Shipping Weight:	Platinum 5 and XL: 58 lbs \pm 2 lbs (26.3 kg \pm 1 kg)
	Platinum 10: 60 lbs \pm 2 lbs (27.2 kg \pm 1 kg)

SECTION 4—TYPICAL PRODUCT PARAMETERS

Operating Ambient Temperature:	50°F - 95°F (10°C - 35°C) at 20-60% relative humidity
Exhaust:	Platinum 5 and XL: Less than Ambient + 35°F (+19°C).
	Platinum 10: Less than Ambient + 45°F (+25°C)
Oxygen Output Temperature:	Platinum 5 and XL: Less than Ambient + 4°F (+2°C)
	Platinum 10: Less than Ambient + 8°F (+4.4°C)
Cabinet:	Impact Resistant flame-retardant plastic cabinet that conforms to UL 94-V0
Regulatory Listing:	Double Insulated Product ETL certified complying with UL 1097 ETL certified to CSA C22.2 No. 68
Electrical:	No extension cords.
Placement:	No closer than three inches from any wall, furniture, draperies, or similar surfaces.
Tubing:	7 ft cannula with a maximum 50 ft of Crush-Proof Tubing (DO NOT pinch). Platinum 10: Recommended use up to 50 ft high flow tubing with high flow cannula at all flow rates.
Relative Humidity:	20 to 60%
Time of Operation:	Up to 24 hours per day.
Recommended Storage and Shipping Temperature:	-20°F to 150°F (-29°C to 65°C), at 15-95% relative humidity

SECTION 5—OPERATING INSTRUCTIONS

Introduction

Your oxygen concentrator is intended for individual use indoors. It is an electronically operated device that separates oxygen from room air. It provides high concentration of oxygen directly to you through a nasal cannula. Clinical studies have documented that oxygen concentrators are therapeutically equivalent to other types of oxygen delivery systems.

Your provider will show you how to use your oxygen concentrator. He/She should be contacted with any questions or problems regarding your oxygen concentrator. This owner's manual will tell you about your concentrator and will serve as a reference as you use your concentrator.

Select a Location

WARNING

NEVER block the air openings of the product or place it on a soft surface, such as a bed or couch, where the air opening may be blocked. Keep the openings free from lint, hair and the like.

Keep unit at least 3 inches away from walls, draperies, furniture, and the like.

You may select a room where using your oxygen concentrator would be most convenient. Your concentrator can be easily rolled from room to room on its casters.

The air intake of the unit should be located in a well ventilated area to avoid airborne pollutants and/or fumes. **DO NOT** place in a closet.

Set-Up

Plug in Power Cord

Plug in power cord to an electrical outlet.

⚠ POLARIZED PLUG WARNING

As a safety feature, this appliance may have a polarized plug (one blade is wider than the other). This plug will fit in a polarized outlet only one way. If the plug does not fit fully in the outlet, reverse the plug. If it still does not fit, contact a qualified electrician. DO NOT attempt to defeat this safety feature.

Connect Humidifier (If So Prescribed)

⚠ WARNING

DO NOT overfill humidifier.

DO NOT reverse the oxygen input and output connections. Water from the humidifier bottle will travel through the cannula back to the patient.

NOTE: For this procedure, refer to FIGURE 5.1, FIGURE 5.2 and FIGURE 5.3 on page 18 and FIGURE 5.4 on page 19.

NOTE: For Platinum 5, XL - recommended humidifiers are: Invacare 3260, 003-40, or 006-40. For Platinum 10, recommended humidifiers are high flow: 7900-10, 7900-25.

1. Remove cap and fill humidifier bottle with distilled water to the level indicated by the manufacturer.
2. Replace the humidifier cap and securely tighten.

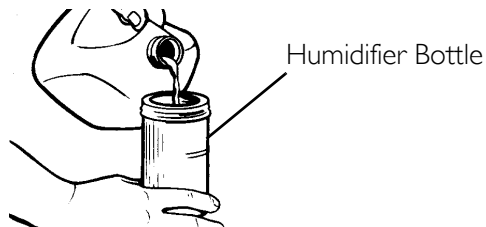

FIGURE 5.1 Filling the Humidifier

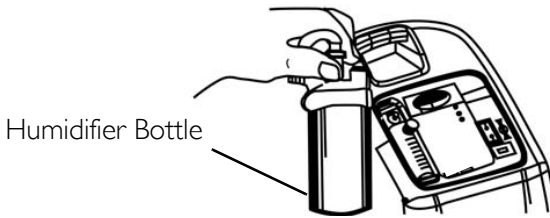

FIGURE 5.2 Humidifier Compartment

3. Remove the filter access door located on the side of the concentrator. Insert a flathead screwdriver in the plate groove on the top edge of the filter access door and gently pry the filter access door open. Refer to Detail "A" in FIGURE 5.3.
4. The humidifier adapter is next to the inlet filter. Pull up and remove the humidifier bottle adapter. Refer to Detail "B" in FIGURE 5.3.
5. Attach it to the humidifier by turning the wing nut on the humidifier bottle counterclockwise until it is securely fastened. Refer to Detail "C" in FIGURE 5.3.
6. Place the humidifier bottle in the humidifier compartment.

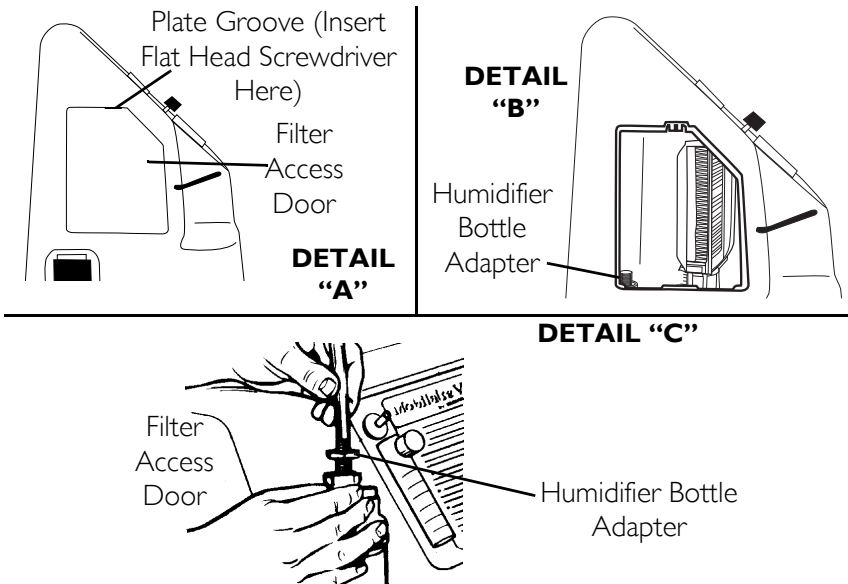

FIGURE 5.3 Attaching the Humidifier Bottle Adapter

7. Attach oxygen tubing from the humidifier bottle to oxygen outlet connector on the oxygen concentrator (FIGURE 5.4).
8. Attach the cannula/patient supply tubing to the humidifier bottle outlet (FIGURE 5.4).
9. After assembly, ensure that oxygen is flowing through the cannula.

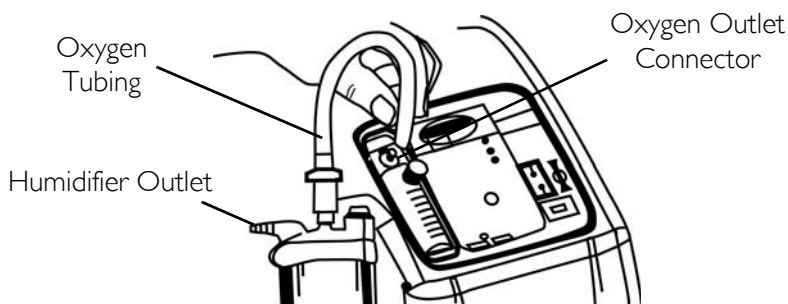

FIGURE 5.4 Attaching the Oxygen Tubing

Power Switch

NOTE: For this procedure, refer to FIGURE 5.5 on page 19.

1. Press power switch to on position. All the panel lights and the audible alarm will come on for one second, indicating that the unit is functioning properly.

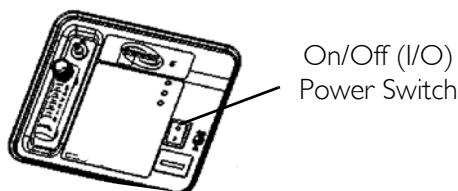

FIGURE 5.5 Power Switch

Flowrate

NOTE: For this procedure, refer to FIGURE 5.6 on page 20.

1. Turn the flowrate knob to the setting prescribed by your physician or therapist.
-

CAUTION

Never set the flow greater than 5 L/min on the IRC5.

Never set the flow greater than 10L/min on the IRC10.

⚠ WARNING

DO NOT change the L/min setting on the flowmeter unless a change has been prescribed by your physician or therapist.

NOTE: To properly read the flowmeter, locate the prescribed flowrate line on the flowmeter. Next, turn the flow knob until the ball rises to the line. Now, center the ball on the L/min. line prescribed.

2. If the flowrate on the flowmeter ever falls below 0.5 L/min for Platinum 5 (1 L/min for Platinum 10) for more than about one minute, the LOW FLOW alarm will be triggered. This is a rapid beeping of the audible alarm. Check your tubing or accessories for blocked or kinked tubing or a defective humidifier bottle. After rated flow is restored, more than 0.5 L/min for Platinum 5 (1 L/min for Platinum 10), the LOW FLOW audible alarm will go off.

NOTE: The use of some accessories such as the pediatric flowstand and the HomeFill compressor will deactivate the Low Flow Alarm.

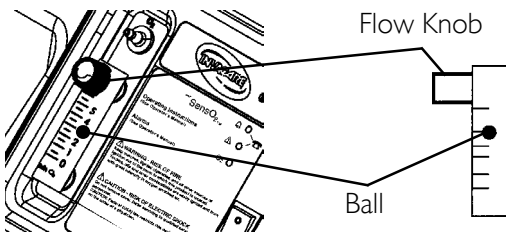

FIGURE 5.6 Flowrate

Front Panel Indicators - Units with SensO₂

NOTE: For this procedure, refer to FIGURE 5.7.

The SensO₂ feature monitors the purity of oxygen generated by the oxygen concentrator. If purity falls below factory preset standards, indicator lights on the control panel will illuminate.

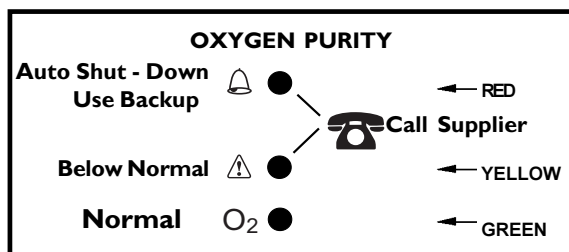



FIGURE 5.7 Front Panel Indicators - Units with SensO₂

Initial Startup of the Concentrator

NOTE: Concentrator may be used during the initial start warm-up time (approximately 30 min.) while waiting for the O₂ purity to reach maximum.

LABEL SYMBOL	O ₂ PURITY	INDICATOR LIGHTS (LED)
O ₂	SYSTEM OKAY O ₂ over 85% (± 2%)	GREEN Indicator Light
	O ₂ Between 73% (± 3%) to 85% (±2%)	YELLOW Indicator light A. YELLOW Solid B. YELLOW Flashing Sensor Failure Call a qualified technician. Have a back-up supply of oxygen ready.
	SYSTEM FAILURE O ₂ Below 73% (±3%)	RED Indicator Light Continuous Audible Alarm Sieve-GARD Compressor Shut-down. Call a qualified technician. Switch to a back-up supply of oxygen immediately.

Front Panel Indicators - Units without SensO₂

NOTE: For this procedure, refer to FIGURE 5.8.

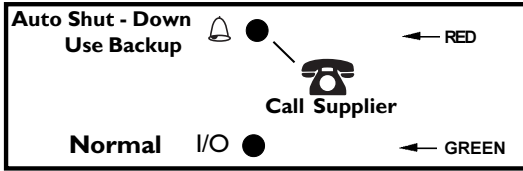



FIGURE 5.8 Front Panel Indicators - Units without SensO₂

Initial Startup of the Concentrator

NOTE: Concentrator may be used during the initial start warm-up time (approximately 30 min). O₂ purity will build to a maximum during this period.

LABEL SYMBOL	STATUS	INDICATOR LIGHTS (LED)
I/O	SYSTEM OKAY	GREEN Indicator Light
	SYSTEM FAILURE	RED Indicator light Continuous Audible Alarm Sieve-GARD™ Compressor Shutdown Call a qualified technician. Switch to a back-up supply of oxygen immediately.

SECTION 6—MAINTENANCE

⚠ WARNING

The Invacare concentrators are specifically designed to minimize routine preventive maintenance. Only qualified personnel should perform preventive maintenance on the concentrator.

Power should be disconnected before beginning preventive maintenance on the Invacare concentrator.

NOTE: At a minimum, preventive maintenance MUST be performed according to the maintenance record guidelines. In places with high dust or soot levels, maintenance may need to be performed more often. Refer to Preventive Maintenance Record on page 25.

Routine Maintenance

NOTE: The following routine maintenance should be performed more frequently. See recommended intervals in each section and preventive maintenance record.

Cleaning the Cabinet Filter

CAUTION

DO NOT operate the concentrator without the filter installed.

NOTE: For this procedure, refer to FIGURE 6.1 on page 24.

NOTE: There are two cabinet filters one located on each side of the cabinet.

1. Remove each filter and clean at least once a week depending on environmental conditions.

NOTE: Environmental conditions that may require more frequent cleaning of the filters include but are not limited to: high dust, smoking, air pollutants, etc.

2. Clean the cabinet filters with a vacuum cleaner or wash in warm soapy water and rinse thoroughly.
3. Dry the filters thoroughly before reinstallation.

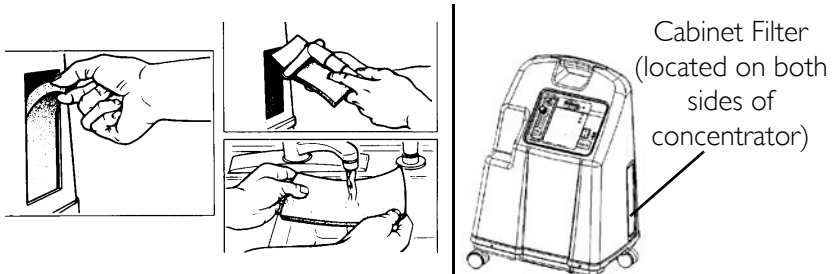

FIGURE 6.1 Cleaning the Cabinet Filter

Cleaning the Cabinet

⚠ WARNING

UNPLUG the concentrator when cleaning. To avoid electrical shock, DO NOT remove cabinet.

Clean the cabinet with a mild household cleaner and non-abrasive cloth or sponge.

Cleaning the Humidifier

NOTE: To clean the oxygen humidifier, follow the instructions provided by the manufacturer. If none are provided, follow these STEPS:

1. Clean the humidifier every day.
2. Wash it in soapy water and rinse it with a solution of ten parts water and one part vinegar.
3. Rinse thoroughly with hot water and refill with distilled water to the level shown on the humidifier.

SECTION 7—TROUBLESHOOTING GUIDE

SYMPTOM:	PROBABLE CAUSE:	SOLUTION:
Alarm: SHORT BEEPS, LONG PAUSE Concentrator NOT operating, power switch ON. Beep.....Beep.....	Main Power Loss: 1. Power cord NOT plugged in.	1. Insert plug into outlet.
	2. No power at outlet.	2. Inspect house circuit breakers or fuses. If problem recurs, use a different outlet.
	3. Tripped circuit breaker.	3. Call Service Provider.
Alarm: CONTINUOUS Concentrator NOT operating, Power Switch ON. Beeeeeeeeep....	System Failure: 1. Unit overheating due to blocked air intake.	1a. Remove and clean cabinet filters. 1b. Move oxygen concentrator at least three inches away from walls, draperies or furniture.
	2. Insufficient power at outlet.	2. DO NOT use extension cords. Move to another electrical outlet or circuit.
	3. Internal repairs required	3. Call Service Provider.
Alarm: RAPID Beep....Beep... Beep...Beep	Low Flow Alarm: 1. Kinked or blocked tubing, cannula or humidifier.	1. Inspect for kinks or blockages. Correct, clean or replace item. Once corrected, turn power OFF for 60 seconds and then turn power back ON.
	2. Flowmeter set too low: 0.5 L/min (or less) for Platinum 5; 1.0 L/min (or less) for Platinum 10.	2. Reset flowmeter to prescribed flowrate. If prescribed flowrate is below 0.5 L/min, use the Pediatric Flowmeter IRCPF16 (Only with Platinum 5 and XL).

SECTION 7—TROUBLESHOOTING GUIDE

SYMPTOM:	PROBABLE CAUSE:	SOLUTION:
<p>YELLOW or RED LIGHT Illuminated.</p> <p>Alarm: CONTINUOUS On red light only.</p> <p>* Only applies to 5LXO₂ and 10LXO₂ SensO₂ models.</p>	1. Low oxygen purity.*	1. Clean or Replace filters.
	2. Kinked or blocked tubing, cannula or humidifier.*	2. Inspect for kinks or blockages. Correct, clean or replace item. Once corrected, turn power OFF for 60 seconds and then turn power back ON.
	3. Flowmeter set too low: 0.5 L/min (or less) for Platinum 5; 1.0 L/min (or less) for Platinum 10.	3. Check flowmeter is set to 1.0 L/min. or more.
	4. Unit overheating due to blocked air intake.	4.a. Remove and clean cabinet filters.
		4b. Move concentrator at least three inches from walls, draperies, and furniture.
	5. Insufficient power at outlet.	5. DO NOT use extension cords. Move to another electrical outlet or circuit.
6. Internal repairs required.	6. Call Service Provider.	
GREEN LIGHT with YELLOW Light Flashing.	1. Internal repairs required.	1. Call Service Provider.

NOTES

NOTES

LIMITED WARRANTY

NOTE: THE WARRANTY BELOW HAS BEEN DRAFTED TO COMPLY WITH FEDERAL LAW APPLICABLE TO PRODUCTS MANUFACTURED AFTER JULY 4, 1975.

This warranty is extended only to the original purchaser who purchases this product when new and unused from Invacare Corporation or a dealer. This warranty is not extended to any other person or entity and it is not transferable or assignable to any subsequent purchaser or owner. Coverage under this warranty will end upon any such subsequent sale or other transfer of title to any other person. This warranty gives you specific legal rights and you may also have other legal rights which may vary from state to state.

Invacare Corporation warrants its Platinum XL Oxygen Concentrators when purchased new and unused to be free from defects in materials and workmanship for a period of five years from date of purchase from Invacare or a dealer, with a copy of the seller's invoice required for coverage under this warranty.

Invacare Corporation warrants its Platinum 10 Oxygen Concentrators when purchased new and unused to be free from defects in materials and workmanship for a period of three years from date of purchase from Invacare or a dealer, with a copy of the seller's invoice required for coverage under this warranty.

DO NOT OPEN OR ATTEMPT TO SERVICE THE 4-WAY VALVE BODY. This will void any and all warranty applicable to the valve body. If within such warranty periods any such product shall be proven to Invacare Corporation's satisfaction to be defective, such product shall be repaired or replaced, at Invacare Corporation's option. This warranty only applies to the labor for repairs performed by the Invacare Service Department or Invacare Authorized Service Centers. It does not apply to the labor performed by the purchaser or user. This warranty does not include normal wear and tear or shipping charges. Invacare Corporation's sole obligation and your exclusive remedy under this warranty shall be limited to such repair or replacement. Routine maintenance items, such as filters, are excluded from this warranty.

For warranty service, please contact Invacare Corporation's Service Department at the toll free number on the back cover. Upon receiving notice of an alleged defect in a product, Invacare Corporation will issue a serialized return authorization. It shall then be the responsibility of the purchaser to return the entire unit or remove, at purchaser's cost, the defective component part(s) identified, pack the component part(s) in a manner to avoid shipping damage and to ship the component part(s) to either Invacare Corporation's plant or service center as specified by Invacare Corporation in advance. Defective component part(s) **MUST** be returned for warranty inspection using the serial number as identification within thirty (30) days of return authorization date. **DO NOT** return products to our factory without prior consent. C.O.D. shipments will be refused; please prepay shipping charges.

LIMITATIONS AND EXCLUSIONS: THE FOREGOING WARRANTY SHALL NOT APPLY TO PRODUCTS SUBJECTED TO NEGLIGENCE, ACCIDENT, IMPROPER OPERATION, MAINTENANCE OR STORAGE, SOOT OR SMOKE-FILLED ENVIRONMENTS, OR OTHER THAN NORMAL APPLICATION, USE OR SERVICE, OR TO PRODUCTS MODIFIED WITHOUT INVACARE CORPORATION'S EXPRESS WRITTEN CONSENT (INCLUDING, BUT NOT LIMITED TO, MODIFICATION THROUGH THE USE OF UNAUTHORIZED PARTS OR ATTACHMENTS) OR TO PRODUCTS DAMAGED BY REASON OF REPAIRS MADE TO ANY COMPONENT WITHOUT THE SPECIFIC CONSENT OF INVACARE CORPORATION OR TO PRODUCTS DAMAGED BY CIRCUMSTANCES BEYOND INVACARE CORPORATION'S CONTROL.

THE FOREGOING EXPRESS WARRANTY IS EXCLUSIVE AND IN LIEU OF ANY OTHER WARRANTIES WHATSOEVER, WHETHER EXPRESS OR IMPLIED, INCLUDING THE IMPLIED WARRANTIES OF MERCHANTABILITY AND FITNESS FOR A PARTICULAR PURPOSE, AND THE SOLE REMEDY FOR VIOLATIONS OF ANY WARRANTY WHATSOEVER, SHALL BE LIMITED TO REPAIR OR REPLACEMENT OF THE DEFECTIVE PRODUCT PURSUANT TO THE TERMS CONTAINED HEREIN. THE APPLICATION OF ANY IMPLIED WARRANTY WHATSOEVER SHALL NOT EXTEND BEYOND THE DURATION OF THE EXPRESS WARRANTY PROVIDED HEREIN. INVACARE SHALL NOT BE LIABLE FOR ANY CONSEQUENTIAL OR INCIDENTAL DAMAGES WHATSOEVER.

SOME STATES DO NOT ALLOW THE EXCLUSION OR LIMITATION OF INCIDENTAL OR CONSEQUENTIAL DAMAGE, OR LIMITATION OF HOW LONG AN IMPLIED WARRANTY LASTS, SO THE ABOVE EXCLUSION AND LIMITATION MAY NOT APPLY TO YOU.

THIS WARRANTY SHALL BE EXTENDED TO COMPLY WITH STATE/PROVINCIAL LAWS AND REQUIREMENTS.

This product may be manufactured under one or more of the following patents: US 5,906,672 and US 5,917,135. Other patents pending.

Invacare Corporation

www.invacare.com



Yes, you can.®

USA

One Invacare Way
Elyria, Ohio USA
44036-2125
800-333-6900
Technical Services
800-832-4707

Trademarks are identified by [™] and [®]. All trademarks are owned by or licensed to Invacare Corporation or its subsidiaries unless otherwise noted.

© 2009 Invacare Corporation

Part No 1118353

Rev J - 4/09



Free Manuals Download Website

<http://myh66.com>

<http://usermanuals.us>

<http://www.somanuals.com>

<http://www.4manuals.cc>

<http://www.manual-lib.com>

<http://www.404manual.com>

<http://www.luxmanual.com>

<http://aubethermostatmanual.com>

Golf course search by state

<http://golfingnear.com>

Email search by domain

<http://emailbydomain.com>

Auto manuals search

<http://auto.somanuals.com>

TV manuals search

<http://tv.somanuals.com>