

611 and 711 Series Swing Clear Continuous Hinges

⚠ CAUTION

Please follow the installation instructions carefully. Not doing so may result in improper installation and void the manufacturer's guarantee.

INSTALLATION NOTES

- Reinforcing and Rivet Nuts:** No reinforcing is necessary except on heavy doors. Reinforcement and rivet nuts are required in the frame and door when door weight exceeds 300 pounds. Maximum door weight is 600 pounds.
- Pairs of Doors with Mullions:** If the mullion is between the doors, treat as a single door installation. If the mullion is behind the doors, treat as a double door installation.

Note: Before proceeding, check to be sure that hinge is proper size. Height of hinge should be 7/8" LESS than opening height. See other side of page for cutting instructions.

1 Mark frame hole locations.

- Determine TOP of hinge using door and frame as guide.
- Open hinge and place frame leaf flat against surface of frame leaving 1/8" gap between top of hinge and bottom of frame header, and edge of hinge frame leaf flush with inside edge of frame.
- Mark hole locations on frame using center punch. A center punch mark is required to start self drilling screws accurately. **DO NOT install hinge to frame at this time.**

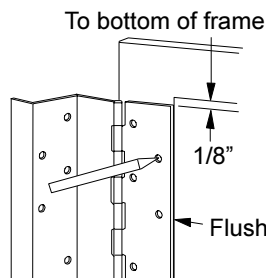

2 Mount hinge to door.

- Place door leaf of hinge against hinge edge of door so that top of hinge is flush with top of door and edge guard is flush with inside face of door.
- With hinge held firmly in place, use #10 x 1/2" self drilling screws to fasten leaf to metal door, or #10 x 1 wood screws to fasten leaf to wood door. **Note:** Fasten top screw first, and bottom most screw second, making sure hinge is aligned correctly.

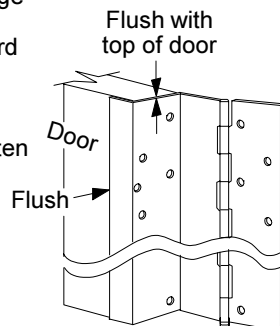

ALL HOLE LOCATIONS ON HINGE LEAF MUST BE FASTENED TO DOOR FOR PROPER OPERATION. FAILURE TO INSTALL ALL FASTENERS WILL VOID WARRANTY AND UL FIRE LABEL LISTINGS.

3 Mount door to frame

- Move door into opening and align mounting holes in frame leaf of hinge with marks on frame made in step 1 above. Note: An angle block, jack or shims will be helpful in positioning the door properly.
- With hinge and door held firmly and accurately in place, use #10 x 1/2" self drilling screws to fasten frame leaf of hinge to frame in marked locations.

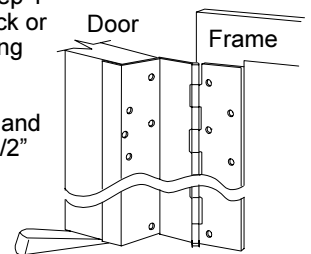

ALL HOLE LOCATIONS ON HINGE LEAF MUST BE FASTENED TO FRAME FOR PROPER OPERATION. FAILURE TO INSTALL ALL FASTENERS WILL VOID WARRANTY AND UL FIRE LABEL LISTINGS.

4 Check for proper operation.

- Close door and check for proper operation and clearances. There should be 1/8" clearance between the top of the door and the bottom of the frame header, and 5/32" clearance between the frame and edge of the door when the door is closed. Adjustments can be made by shimming frame or door leaf of hinge.

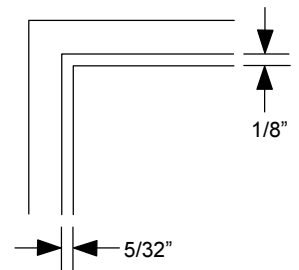

Instructions for Cutting Hinge

1 Determine hinge height.

- A. Measure height of opening from finished floor to underside of door frame header.
- B. Hinge height is height of opening MINUS 7/8".

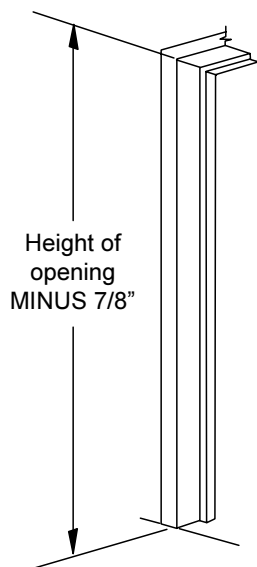

2 Mark hinge for cutting.

- A. Determine which end of hinge will be the TOP using door and frame as a guide.
- B. Open hinge to expose back of hinge (holes are NOT countersunk).
- C. Measure hinge height calculated in step 1 from top of hinge.
- D. Using square, mark a line on back of both hinge leaves and the barrel.

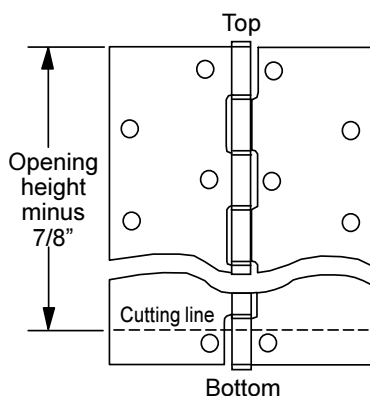

DOUBLE CHECK MEASUREMENT BEFORE CUTTING!
NOTE: Cut end of hinge must be used as BOTTOM OF HINGE ONLY!

3 Cut hinge.

- A. Fold hinge so that cut line is visible.
- B. Starting on barrel, cut through entire hinge along line.
- C. Deburr all cut edges with file.
- D. Use center punch or heavy gauge nail on pin in short cut off portion of hinge to remove hinge tip. **SAVE HINGE TIP** for use in step 5.

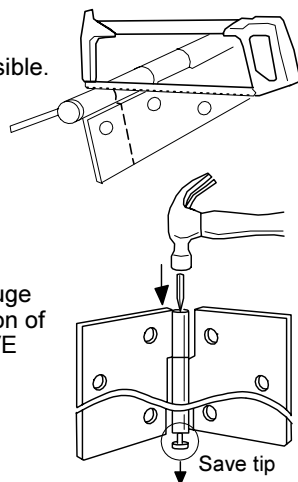

4 Shorten hinge pin 3/4\"/>

- A. Using center punch or heavy nail, tap on cut surface of hinge pin to remove top hinge tip (save tip for step 5).
- B. Expose 1" of hinge pin. Measure and mark 3/4" from end of pin.
DOUBLE CHECK MEASUREMENT BEFORE CUTTING.
- C. Cut pin at mark.

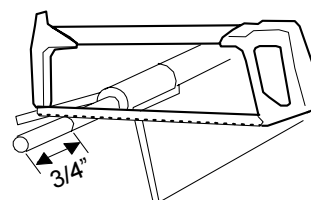
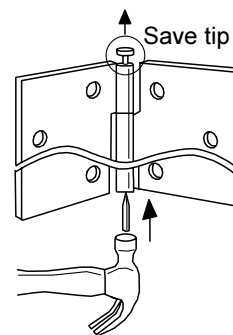

5 Insert top and bottom tip.

- A. Tap hinge pin back into barrel.
- B. Tap hinge pin tips (retained from step 3 and 4) firmly into top and bottom of barrel until shoulder sets squarely on barrel.

NOTE: Both tips **MUST BE INSTALLED** to hold hinge pin in position.

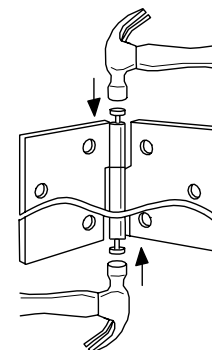

6 Important Note:

If more than 6" is cut from bottom of hinge, additional mounting holes will be required on bottom of hinge. Use cut off piece of hinge to mark and prepare hole locations on bottom of hinge.

Free Manuals Download Website

<http://myh66.com>

<http://usermanuals.us>

<http://www.somanuals.com>

<http://www.4manuals.cc>

<http://www.manual-lib.com>

<http://www.404manual.com>

<http://www.luxmanual.com>

<http://aubethermostatmanual.com>

Golf course search by state

<http://golfingnear.com>

Email search by domain

<http://emailbydomain.com>

Auto manuals search

<http://auto.somanuals.com>

TV manuals search

<http://tv.somanuals.com>