

The JBL logo is displayed in white, bold, sans-serif capital letters within an orange square background.

Simply Cinema™



SCS110

simple

set-up guide

thank you for choosing JBL. For over 50 years, JBL has been involved in every aspect of musical and film recording and reproduction, from live performances to monitoring the recordings you play in your home, car, or office.

We're confident that the **JBL system** you have chosen will provide every note of enjoyment that you expected – and that when you think about purchasing additional audio equipment for your home, car, or office, you will once again choose JBL.

Please take a moment to complete the enclosed profile card. It enables us to keep you posted on our latest advancements, and helps us to better understand our customers and build products that meet your needs and expectations.

JBL Consumer Products

read first! Before you begin

included

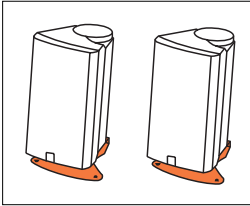

Two satellite speakers
(with removable shelf stands).

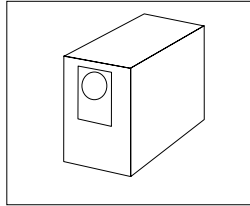

One subwoofer.

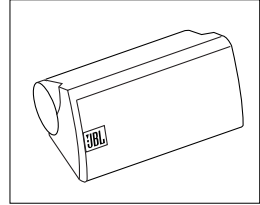

One sat10 center speaker.

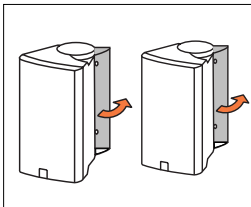

One pair of sat10 surround
speakers with removable
wall-mounting brackets.

features

- 2-way satellite speakers with 3/4" titanium composite dome high-frequency drivers.
- Triple chamber band-pass subwoofer.
- Adjustable satellites with shelf stands included.
- Adjustable, removable wall-mounting brackets (for use with surround speakers).
- Video-shielded satellites.
- Recessed wire channels on satellites and surrounds.
- Diffraction-limiting foam satellite baffles.

one. Speaker Placement

Satellites

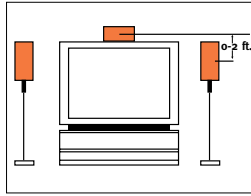
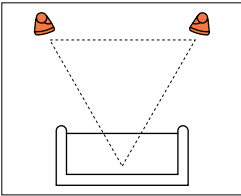

Subwoofer

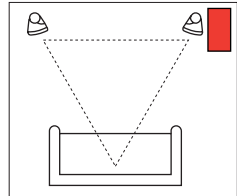

Surround Speakers

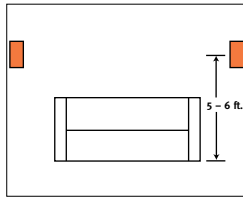
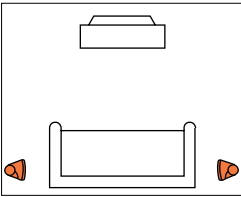

Mounting Options

Satellites

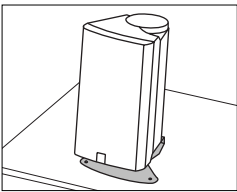

On shelves.

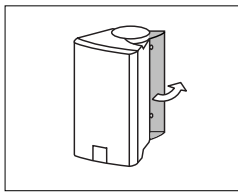

On the wall. Optional bracket.
Part No. SFX10BKT, or
SFX10BKTWHT (white).

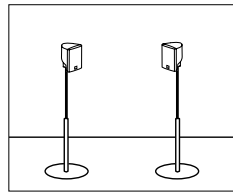

On optional stands.
Part No. FS10/20.
FS10/20WHT (white).

Surrounds

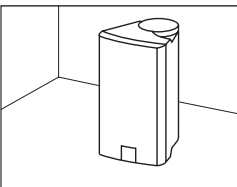

On shelves.

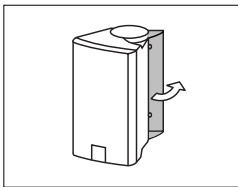

Wall-mounted. Brackets and
hardware included.

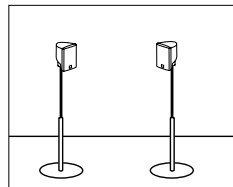

On optional stands.

two. Speaker Connections

Connection Tips

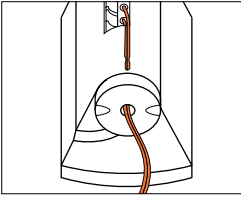

For satellites, thread speaker wire through the hole in the bottom of the speaker, then feed it through the recessed wire channel.

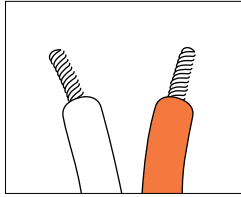

Separate and strip the ends of the speaker wire as shown. Speakers and electronics terminals have corresponding (+) and (-) terminals. It is important to connect both speakers

identically: (+) on the speaker to (+) on the amplifier and (-) on the speaker to (-) on the amplifier. Wiring "out of phase" results in thin sound, weak bass and a poor stereo image.

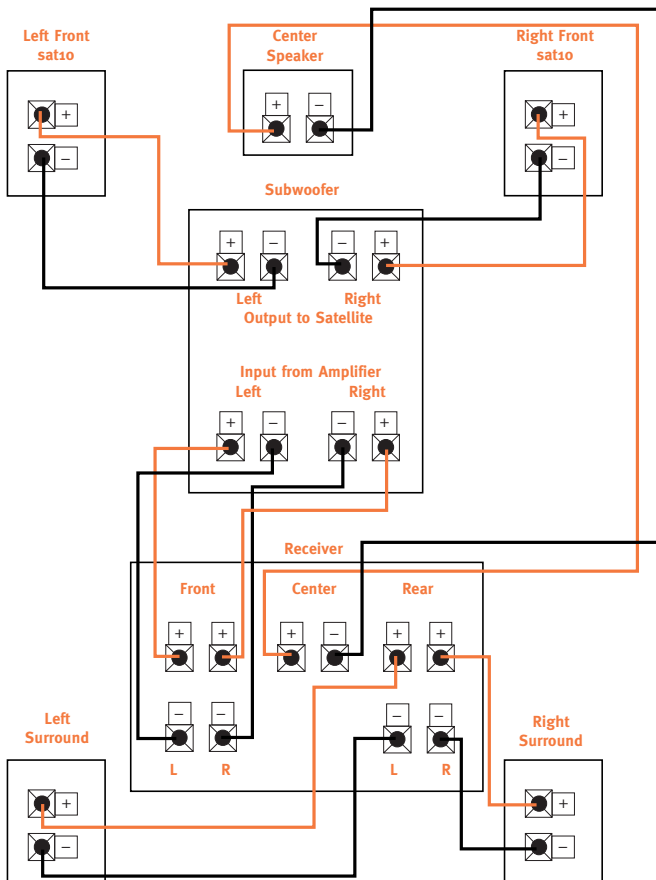

three. Testing

Finally. Take a “test drive” with some favorite music or movies.

1. With the receiver/amplifier still turned off, confirm that its volume control is turned all the way down. Next, center the balance control. If the receiver/amplifier has an A/B speaker switch, set it to correspond to the speaker terminals connected to the SCS110 system.

2. Now, turn on your receiver/amplifier and select a music source such as a CD player, cassette deck or FM tuner.

3. Turn up the volume control slowly until you hear sound from the speakers.

4. Rotate the balance control all the way to the left. Sound should come only from the left speaker. If the sound comes from the right speaker with the balance control to the left, the speaker wires have been reversed during hook-up. Turn the receiver/amplifier “off” and switch both sets of speaker wires. Dolby Pro Logic*-equipped devices (AV Receivers, Surround Sound processors or decoders, TVs or other sources) include a “test tone” you can use to balance the

volume of all the speakers in a surround sound system. Refer to the instructions accompanying your component for selecting the test tone mode and using it to balance speaker levels in your home theater.

Troubleshooting

If there is no sound from any of the speakers, check the following:

- Receiver/amplifier is on and a source is playing.
- Review proper operation of your receiver/amplifier.

If there is no sound coming from one speaker, check the following:

- Check the “Balance” control on your receiver/amplifier.
- Check all wires and connections between receiver/amplifier and speakers.
- Make sure all wires are connected. Make sure none of the speaker wires are frayed, cut, or punctured.

If the system plays at low volumes but shuts off as volume is increased, check the following:

- Check all wires and connections between receiver/amplifier and speakers.
- Make sure all wires are connected. Make sure none of the speaker wires are frayed, cut, or punctured.
- If more than one pair of main speakers is being used, check the minimum impedance requirements of your receiver/amplifier.

If there is low bass output, check the following:

- Make sure the polarity (+ and –) of the left and right “Speaker Inputs” are connected properly.

If there is no sound from the surround speakers, check the following:

- Check all wires and connections between receiver/amplifier and speakers.
- Make sure all wires are connected. Make sure none of the speaker wires are frayed, cut, or punctured.
- Review proper operation of your receiver/amplifier and its surround sound features.

Specifications

SCS110 System

Power Handling

10 – 120 watts

Frequency Response

40Hz – 20kHz (±3dB)

Accessories such as the optional stands and brackets are available through your JBL dealer. For a dealer in the USA call 1-800-336-4JBL.

Refinements may be made on occasion to existing products without notice, but will always meet or exceed original specifications unless otherwise stated.

Notice to Purchaser: JBL assumes no responsibility or liability for injuries or property damage – direct, indirect, or consequential – resulting from the improper installation of these loudspeakers.



JBL Consumer Products
80 Crossways Park West, Woodbury, NY 11797
8500 Balboa Boulevard, Northridge, CA 91329
1-800-336-4JBL (4525) (USA only)

© 1996 JBL, Incorporated. JBL and Simply Cinema are registered trademarks of JBL, Incorporated.
*Trademark of Dolby Laboratories.

Printed in USA 8/96 ♻️ Part No. SCS1100M

Ⓜ️ A Harman International Company

sat10

Power Handling

10 – 80 watts

Frequency Response

150Hz – 20kHz (±3dB)

Impedance

8 ohms nominal

Sensitivity

88dB @ 1 watt/1 meter

Crossover Frequency

3.5kHz (midrange to tweeter)

Tweeter

One 3/4" titanium composite dome, video-shielded

Midrange

One 3-1/2" neodymium driver, video-shielded

Dimensions (HxWxD)

6-1/2 x 3-3/4 x 4-1/4 inches

165 x 95 x 108mm

Weight

1.5 lbs/.7 kg

bass10

Power Handling

10 – 120 watts

Frequency Response

40Hz – 150Hz (±3dB)

Impedance

8 ohms nominal

Sensitivity

88dB @ 1 watt/1 meter

Crossover Frequency

150Hz (subwoofer to satellite)

Bass

Two 5-1/4" woofers
Triple chamber band-pass subwoofer

Dimensions (HxWxD)

14-3/4 x 8-1/2 x 19 inches

375 x 216 x 465mm

Weight

28 lbs/12.7 kg

sat10 Surround Speakers

Recommended Power

10 – 70 watts

Impedance

8 ohms nominal

Sensitivity

90dB @ 1 watt/1 meter

Frequency Response

100Hz – 15kHz (±3dB)

Dimensions (HxWxD)

6-1/2 x 3-3/4 x 4-1/4 inches

165 x 95 x 108mm

Weight

1.5 lbs/.7 kg

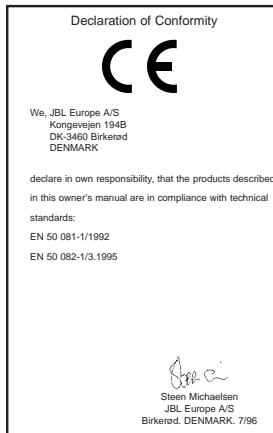

Free Manuals Download Website

<http://myh66.com>

<http://usermanuals.us>

<http://www.somanuals.com>

<http://www.4manuals.cc>

<http://www.manual-lib.com>

<http://www.404manual.com>

<http://www.luxmanual.com>

<http://aubethermostatmanual.com>

Golf course search by state

<http://golfingnear.com>

Email search by domain

<http://emailbydomain.com>

Auto manuals search

<http://auto.somanuals.com>

TV manuals search

<http://tv.somanuals.com>