



**AS5, AS6,**  
**AS8, AS65C**  
**& AS SUB**  
**simple**  
**set-up guide**

**thank you** for choosing JBL. For over 50 years, JBL has been involved in every aspect of musical and film recording and reproduction, from live performances to monitoring the recordings you play in your home, car, or office.

We're confident that the **JBL loudspeakers** you have chosen will provide every note of enjoyment that you expected – and that when you think about purchasing additional audio equipment for your home, car, or office you will once again choose JBL.

Please take a moment to complete the enclosed profile card. It enables us to keep you posted on our latest advancements, and helps us to better understand our customers and build products that meet your needs and expectations.

JBL Consumer Products

# one. Speaker Placement

## AS5, AS6, AS8 as front speakers

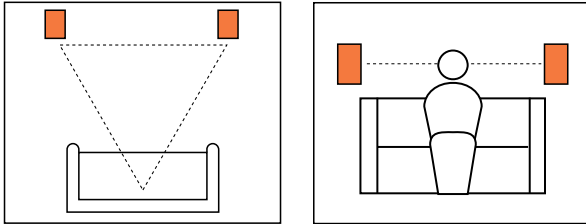

## AS5, AS6, AS8 as rear speakers

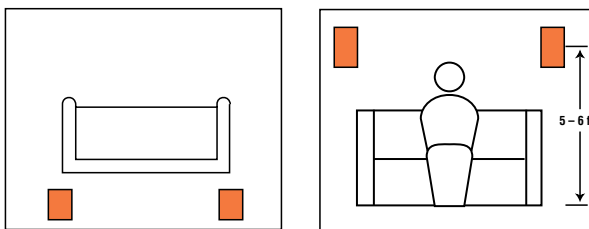

## AS65C in ceiling

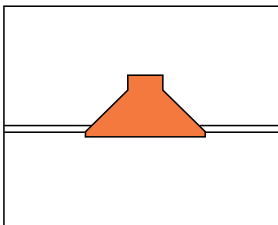

## AS SUB

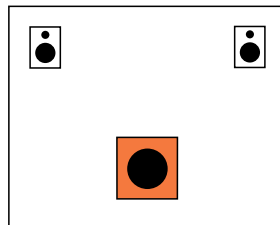

## two. Speaker Connections

### Connection Tips

**Wire Length**  
 Up to 20 ft.  
 Up to 30 ft.  
 Greater than 30 ft.

**Recommended Size**  
 16 gauge  
 12 gauge  
 10 gauge

The wires for both speakers should be the same length. If one speaker is placed closer to the amplifier than the other, hide the excess wire behind the wall.

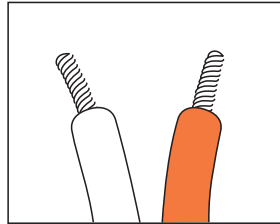

Speakers and electronics terminals have corresponding (+) and (-) terminals. It is important to connect both speakers identically: (+) on the speaker to (+) on the amplifier and (-) on the speaker to (-) on the amplifier. Wiring "out of phase" results in thin sound, weak bass and a poor stereo image.

### AS5, AS6, AS8, AS65C

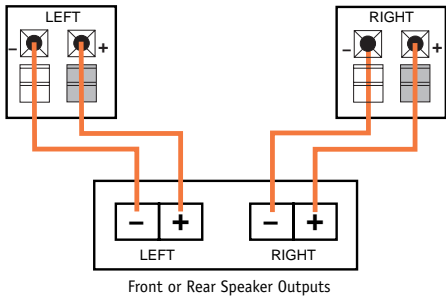

### AS SUB

The AS SUB has two pairs of speaker connections. Connect one set of terminals (input) to the left channel of your

amplifier. Connect the other set of terminals (input) to the right channel of your amplifier. Then connect the left satellite to the

left output and the right satellite to the right output.

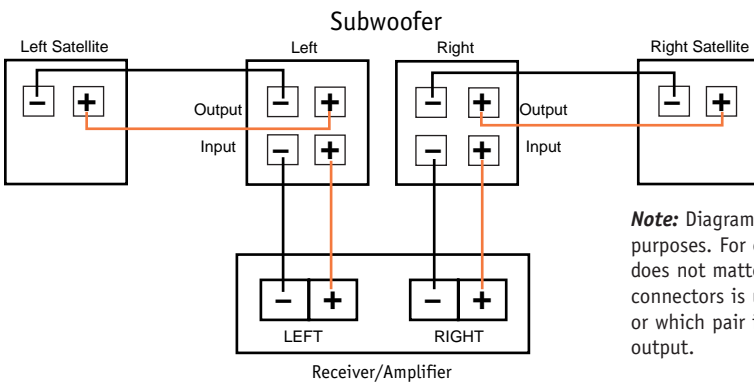

**Note:** Diagram is for illustrative purposes. For each channel it does not matter which pair of connectors is used for the input or which pair is used for the output.

# three. Installation

The AS Series in-wall speakers were designed to be easily installed. However, if you are unsure of your ability to

properly install these loudspeakers, please contact your dealer or a qualified installer.

## Tools Needed

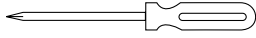

Phillips #2 screwdriver

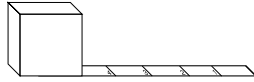

Measuring tape

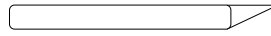

Utility knife



Pencil

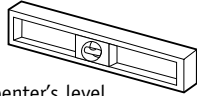

Carpenter's level

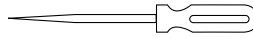

Awl

## AS5, AS6, AS8

### Installation Kit

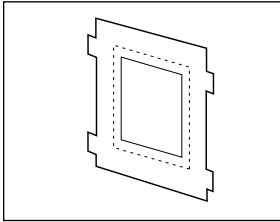

Template

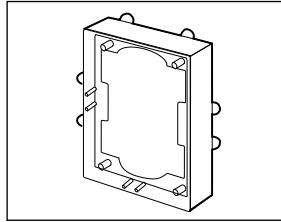

Speaker frame

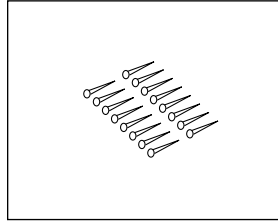

Thread-forming screws

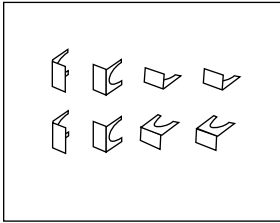

Retainer clips

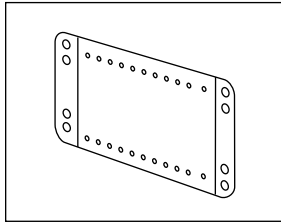

Four mounting brackets

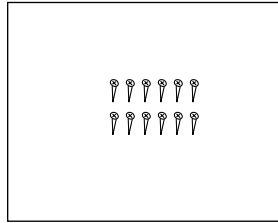

Short phillips head screws

## Existing Construction

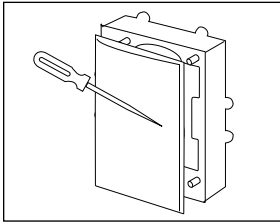

**Step One:**  
Remove the grille from the speaker frame.

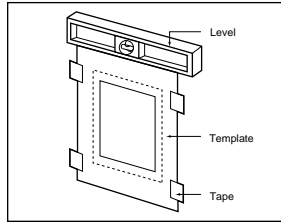

**Step Two:**  
Determine the correct speaker location.

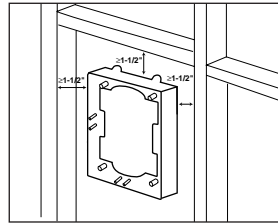

**Step Three:**  
Determine the speaker-frame location.

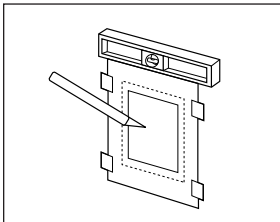

**Step Four:**  
Cut the dry wall.

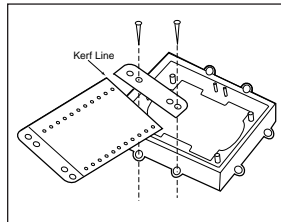

**Step Five:**  
Place the mounting bracket on the speaker frame using the mounting guides (marked 3/8", 1/2", 5/8", and 3/4") corresponding to the thickness of the dry wall.

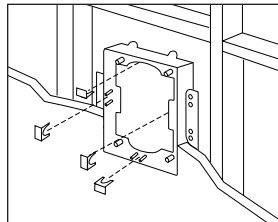

**Step Six:**  
Place the frame assembly in the wall.

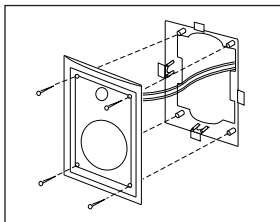

**Step Seven:**  
Connect the speaker wires to the baffle assembly and install baffle assembly in frame.  
**Do not overtighten the baffle screws.**

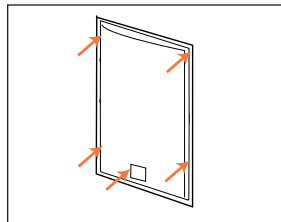

**Step Eight:**  
Replace the metal grille.

## New Construction

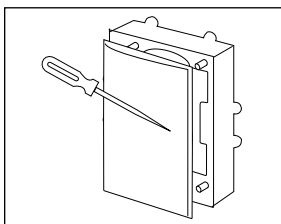

**Step One:**  
Remove the grille from the speaker frame.

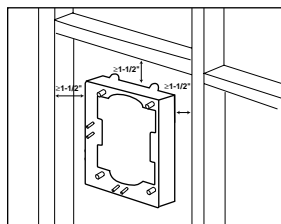

**Step Two:**  
Determine the correct speaker location.

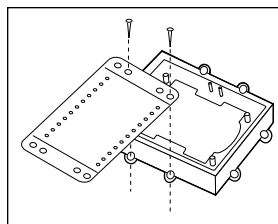

**Step Three:**  
Attach the proper mounting brackets, marked and preset at 3/8", 1/2", 5/8", and 3/4", corresponding to the thickness of the dry wall, to the speaker frame.

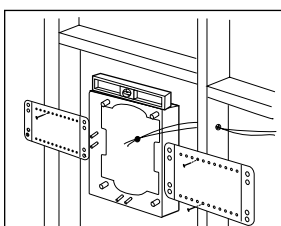

**Step Four:**  
Nail or screw the speaker-frame assembly to the wall studs and route the wires through the frame opening.

## After the Drywall is Installed

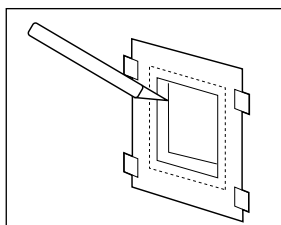

**Step Five:**  
Cut the drywall.

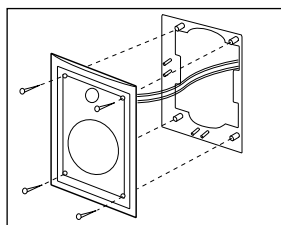

**Step Six:**  
Connect the speaker wires to the baffle assembly and install baffle assembly in frame. **Do not overtighten the baffle screws.**

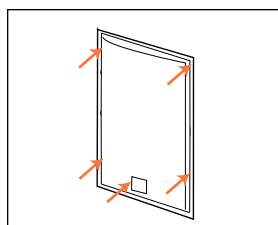

**Step Seven:**  
Replace the metal grille.

### AS SUB

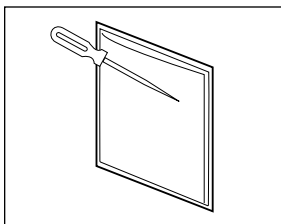

**Step One:**  
Remove the grille from the subwoofer frame.

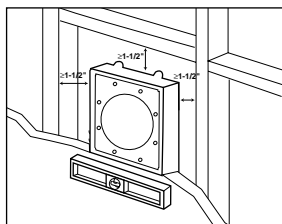

**Step Two:**  
Determine the correct subwoofer location.

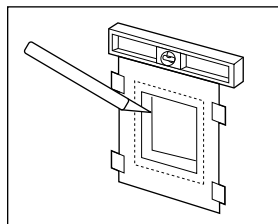

**Step Three:**  
Cut the drywall.

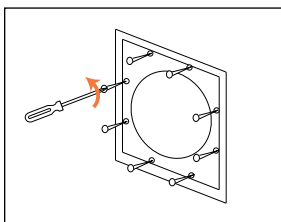

**Step Four:**  
Loosen the eight phillips head screws until the locking tabs turn inward.

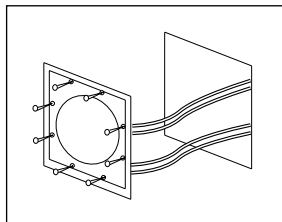

**Step Five:**  
Connect the speaker wires to the baffle assembly.

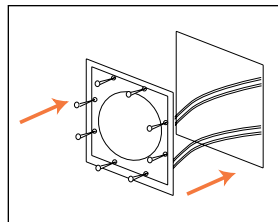

**Step Six:**  
Place the subwoofer in the wall.

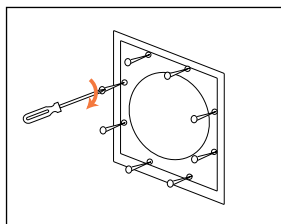

**Step Seven:**  
Screw down each of the eight phillips head screws. The tabs will swivel into place and secure the unit to the rear surface of the drywall.

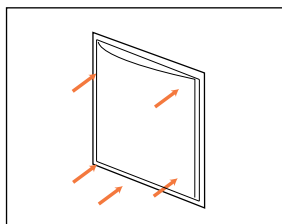

**Step Eight:**  
Replace the metal grille.

### AS65C

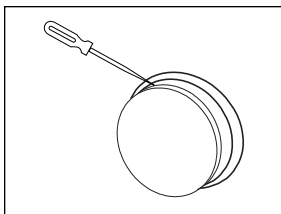

**Step One:**  
Remove the grille from the speaker frame.

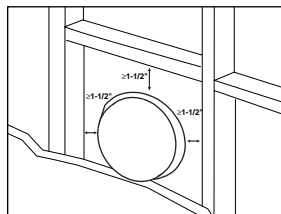

**Step Two:**  
Determine the correct speaker location.

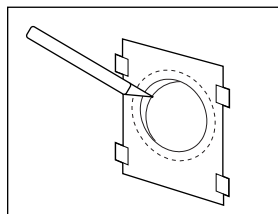

**Step Three:**  
Cut the drywall.

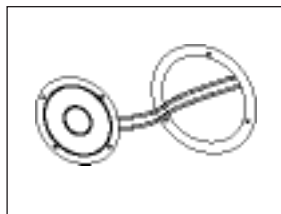

**Step Four:**  
Connect the speaker wires to the speaker.

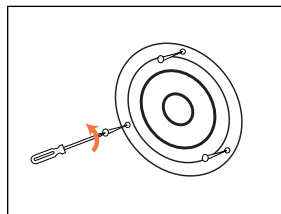

**Step Five:**  
Loosen the three phillips head screws on the frame until the locking tabs turn inward.

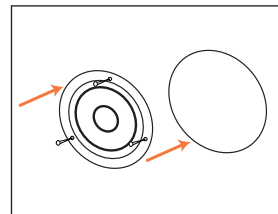

**Step Six:**  
Place the frame assembly in the wall.

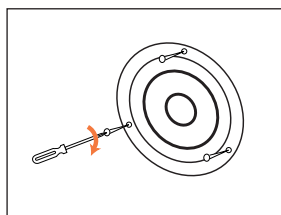

**Step Seven:**  
Screw down each of the three phillips head screws. The tabs will swivel into place and secure the unit to the rear surface of the drywall.

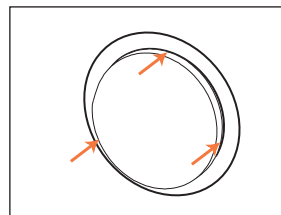

**Step Eight:**  
Replace the metal grille.



## Painting the Speaker Frame and Grille

AS Series loudspeakers can be painted to match any style of decor. If you wish to change their color, the satin finish on the grille and frame will function as a primer coat. Before painting, install the paint guard (in the assembly kit) securely into the recess in the baffle.

This will protect the speaker components and baffle from paint residue. Use a high-quality spray paint, and apply a thin coat of color. **Be certain the grille perforations remain free of paint. Filling them with paint will diminish the sound quality.**

**Note:** Gently remove the acoustical foam blanket from the grille before painting. Reattach the blanket after the paint has dried.

## Troubleshooting

**If there is no sound from either of the speakers, check the following:**

- Receiver/amplifier is on and a source is playing.
- Check all wires and connections between receiver/amplifier and speakers. Make sure all wires are connected. Make sure none of the speaker wires are frayed, cut, or punctured.
- Review proper operation of your receiver/amplifier.

**If there is no sound coming from one speaker, check the following:**

- Check the "Balance" control on your receiver/amplifier.
- Check all wires and connections between receiver/amplifier and speakers. Make sure all wires are connected. Make sure none of the speaker wires are frayed, cut, or punctured.

**If there is low bass output, check the following:**

- Make sure the connections to the left and right "Speaker Inputs" have the correct polarity (+ and -).

**If the system plays at low volumes but shuts off as volume is increased, check the following:**

- Check all wires and connections between receiver/amplifier and speakers. Make sure all wires are connected. Make sure none of the speaker wires are frayed, cut, or punctured.
- If more than one pair of main speakers is being used, check the minimum impedance requirements of your receiver/amplifier.

## Specifications

SYSTEM	AS5	AS6	AS65C
<b>Frequency Response (-6dB):</b>	50Hz - 20kHz	40Hz - 20kHz	45Hz - 20kHz
<b>Recommended Maximum</b>			
<b>Amplifier Power*:</b>	40 watts	50 watts	50 watts
<b>Sensitivity:</b>	88dB	90dB	90dB
<b>Impedance:</b>	8 ohms nominal	8 ohms nominal	8 ohms nominal
<b>Crossover Frequency:</b>	6kHz	5kHz	7kHz
<b>Woofers:</b>	5-1/4"	6-1/2"	6-1/2"
<b>Tweeters:</b>	1" titanium	1" titanium	1" titanium
<b>Outside Dimensions (HxWxD**):</b>	11 x 7-1/2 x 2-5/8" 280 x 190 x 67mm	13 x 7-1/2 x 2-3/4" 330 x 190 x 70mm	8-1/8 (dia.) x 2-3/4" 206 (dia.) x 70mm

SYSTEM	AS8	AS SUB
<b>Frequency Response (-6dB):</b>	35Hz - 20kHz	32Hz - 300Hz
<b>Recommended Maximum</b>		
<b>Amplifier Power*:</b>	60 watts	120 watts
<b>Sensitivity:</b>	88dB	88dB
<b>Impedance:</b>	8 ohms nominal	8 ohms nominal
<b>Crossover Frequency:</b>	5kHz	300Hz
<b>Woofers:</b>	8"	8"
<b>Tweeters:</b>	1" titanium	N/A
<b>Outside Dimensions (HxWxD**):</b>	15-1/8 x 11 x 3-1/4" 385 x 280 x 83mm	11-13/16 x 11-13/16 x 3-1/4" 300 x 300 x 83mm

Occasional refinements may be made to existing products without notice, but will always meet or exceed original specifications unless otherwise stated.

\*The maximum recommended amplifier power rating will ensure proper system headroom to allow for occasional peaks. We do not recommend sustained operation at these maximum power levels.

\*\* Mounting depth.



JBL Consumer Products  
80 Crossways Park West, Woodbury, NY 11797  
8500 Balboa Boulevard, Northridge, CA 91329  
1-800-336-4JBL (4525) (USA only)  
www.jbl.com

© 1996 JBL, Incorporated. JBL is a registered trademark of JBL, Incorporated.

Printed in USA 2/97 ♻️ Part No. ASOM

**H** A Harman International Company

Declaration of Conformity



We, JBL Europe A/S  
Kongevejen 194B  
DK-3460 Birkerød  
DENMARK

declare in own responsibility, that the loudspeakers described in this owner's manual are in compliance with technical standards:

EN 50 081-1/1992  
EN 50 082-1/3.1995

Stein Michaelson  
JBL Europe A/S  
Birkerød, DENMARK, 7/96

## Free Manuals Download Website

<http://myh66.com>

<http://usermanuals.us>

<http://www.somanuals.com>

<http://www.4manuals.cc>

<http://www.manual-lib.com>

<http://www.404manual.com>

<http://www.luxmanual.com>

<http://aubethermostatmanual.com>

Golf course search by state

<http://golfingnear.com>

Email search by domain

<http://emailbydomain.com>

Auto manuals search

<http://auto.somanuals.com>

TV manuals search

<http://tv.somanuals.com>