

GRAND
TOURING®
SERIES

GTO17T

tweeter
owner's
manual

THANK YOU
for purchasing a JBL® GTO17T automotive
tweeter. We've organized this manual to make
your installation as simple and trouble-free
as possible. Please read it thoroughly before
proceeding. Remember to keep your sales
receipt and this manual in a safe place so
both are available for future reference.



JBL

THE OFFICIAL BRAND
OF LIVE MUSIC.®

Download from [Www.S...](http://www.S...)

INSTALLATION WARNINGS AND TIPS

ABOUT THESE INSTRUCTIONS

Installation of automotive stereo components can require extensive experience with a variety of mechanical and electrical procedures. Although these instructions explain how to install JBL GT017T tweeters in a general sense, they do not show the exact installation methods for your particular vehicle. If you feel you do not have the experience, do not attempt the installation yourself – instead, ask your authorized JBL car audio dealer about professional installation options.

LOUD MUSIC AND HEARING

Playing loud music in an automobile can permanently damage your hearing, as well as hinder your ability to hear traffic. The maximum volume levels achievable with JBL speakers, combined with high power amplification, may exceed safe levels for extended listening. We recommend using low volume levels when driving. JBL accepts no liability for hearing loss, bodily injury or property damage as a result of use or misuse of this product.

ABOUT THE FILTER

Passive filter design involves precise circuit design and component selection. Moreover, a well-designed filter circuit provides an intended electrical response, when combined with the electrical properties of the speaker, to provide a particular acoustic response. Each enclosed filter has been optimized to provide a flat response when used with a JBL GT017T tweeter.

Do not use another brand or type of passive crossover, or connect more than one tweeter to a crossover. Doing so may damage the tweeter.

INSTALLATION TIPS

- Always wear protective eyewear when using any tools.
- Turn off all audio components and other electrical devices before you start. Disconnect the negative (-) lead from your vehicle's battery.
- Keep speakers in their package until final installation. When moving a speaker, always rest it with the cone or dome facing up. Never use force to install any speaker.
- Check clearances on both sides of a planned mounting surface before drilling any holes or installing any screws. Remember that the screws can extend behind the surface.
- At the installation sites, locate and make a note of all fuel lines, hydraulic brake lines, vacuum lines and electrical wiring. Use extreme caution when cutting or drilling in and around these areas.
- Before drilling or cutting holes, use a utility knife to remove unwanted fabric or vinyl to keep material from snagging in a drill bit or saw.
- For door installations, check the clearance with the windows throughout the range of the window's travel, and verify that a mounted speaker will not interfere with the window crank or power-window mechanism.
- If mounting speakers elsewhere, check for clearance around rear-deck torsion bars, glove box or other structural elements.
- Do not mount speakers where they will get wet.

SPEAKER PLACEMENT

ABOUT PLACEMENT

Figures 1 through 3 show possible speaker placements, with Figure 1 being more desirable. We recommend using the kick panel for mounting to obtain the best staging and imaging in most vehicles.

Figure 1. Mounting the woofer and tweeter in the kick panel.

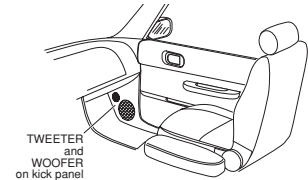

Figure 2. Mounting the woofer in the door and the tweeter in the kick panel.

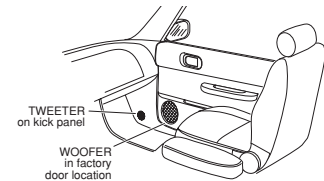
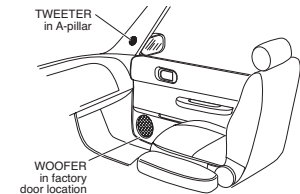

Figure 3. Mounting the woofer in the door and the tweeter in the A-pillar.



TWEETER INSTALLATION

SURFACE-MOUNT

Figure 4. Surface-mounting the tweeter and connecting the crossover.

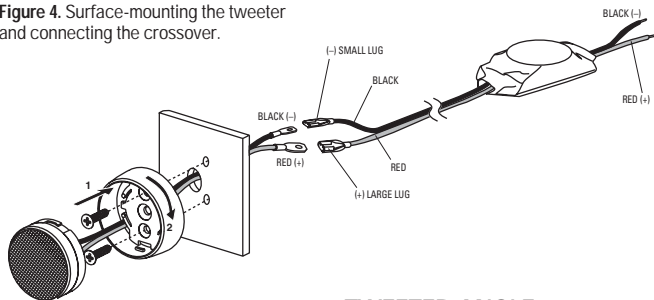

FLUSH-MOUNT

Figure 5. Mounting the tweeter using the I-Mount™ (patent no. 5,859,917) flush-mounting kit.

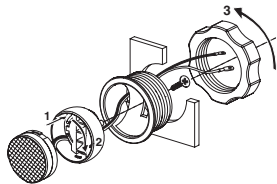

TWEETER ANGLE

Figure 6. Aim the tweeter at the listening position by sliding the screw in the groove on the back of the tweeter cup and lock the tweeter in place using the small retaining screw. Rotate the entire assembly in the mounting surface and tighten the large hand nut.

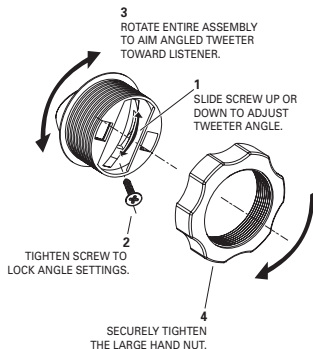

Figures 7A through 7D. The Starfish™ tweeter mount is intended to be used when the tweeter will be installed behind a factory grille (e.g., replacing the factory tweeter behind a door panel). The Starfish will allow you to mount the component tweeter directly to the panel itself or to the area behind the panel. The six mounting tabs can be removed easily to create a number of custom configurations.

Note: Check screw clearance before installing. Use glue if clearance is an issue.

Note: Not all possible mounting configurations are shown.

Figure 7A. Surface-mounted behind grille panel.

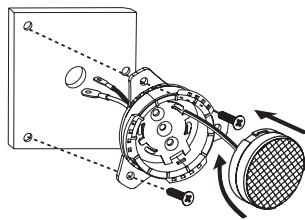

Figure 7B. Flush-mounted to surface behind grille panel.

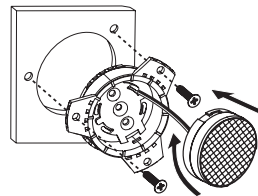

Figure 7C. Mounted to grille panel.

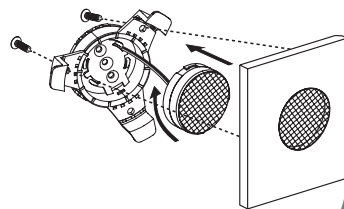
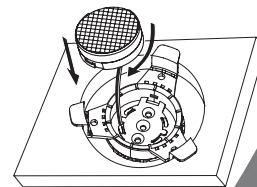

Figure 7D. In-dash location (may require gluing).



SPECIFICATIONS

	GT017T
	1" Tweeter
Power Handling, RMS	50W*
Power Handling, Peak	150W*
Sensitivity (2.83V/1m)	92dB
Frequency Response	2.5kHz – 21kHz
Impedance	2 Ohms
Mounting Depth	3/4" (19mm)
Cutout Diameter	1-7/8" (48mm)

* With enclosed filter

General Care

The loudspeaker grilles may be cleaned with a damp cloth. Do not use any cleaners or solvents on the grilles or the speaker cones.

A valid serial number is required for warranty coverage.

Features, specifications and appearance are subject to change without notice.

JBL Consumer Products
250 Crossways Park Drive, Woodbury, NY 11797 USA
516.255.4JBL (4525) (USA only) www.jbl.com

© 2005 Harman International Industries, Incorporated. All rights reserved.

JBL, Harman International and Grand Touring Series are trademarks of Harman International Industries, Incorporated, registered in the United States and/or other countries. I-Mount and Starfish are trademarks of Harman International Industries, Incorporated.

Part No. GT017TOM11/05

H A Harman International® Company

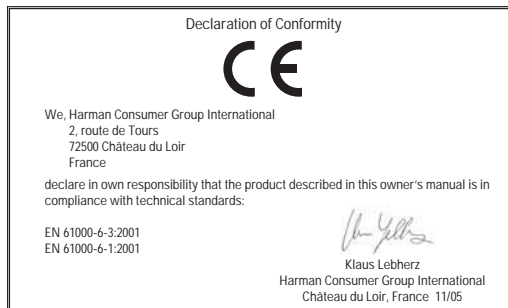

www.jbl.com

Free Manuals Download Website

<http://myh66.com>

<http://usermanuals.us>

<http://www.somanuals.com>

<http://www.4manuals.cc>

<http://www.manual-lib.com>

<http://www.404manual.com>

<http://www.luxmanual.com>

<http://aubethermostatmanual.com>

Golf course search by state

<http://golfingnear.com>

Email search by domain

<http://emailbydomain.com>

Auto manuals search

<http://auto.somanuals.com>

TV manuals search

<http://tv.somanuals.com>