

# EON<sup>®</sup>G2

GENERATION 2

## *EON10 G2 User Guide*



Part Number: 981-00061-01



# Contents

<b>PACKAGE CONTENTS</b> .....	<b>4</b>
<b>AGENCY APPROVALS AND CERTIFICATIONS</b> .....	<b>4</b>
<b>BEFORE YOU BEGIN - IMPORTANT INFORMATION</b> .....	<b>4</b>
<i>Mounting / Suspending EON Speakers</i> .....	<b>4</b>
<i>Care and Maintenance</i> .....	<b>5</b>
<i>Stand Mounting and Precautions</i> .....	<b>5</b>
<i>Electrical Safety</i> .....	<b>5</b>
<b>ABOUT THE EON10 G2</b> .....	<b>6</b>
<i>Applications</i> .....	<b>6</b>
<i>Features</i> .....	<b>6</b>
<i>Specifications</i> .....	<b>6</b>
<i>Frequency Response</i> .....	<b>7</b>
<b>BLOCK DIAGRAM</b> .....	<b>7</b>
<i>Available Accessories</i> .....	<b>7</b>
<b>QUICKSTART</b> .....	<b>8</b>
<b>CONTROLS AND CONNECTIONS</b> .....	<b>8</b>
<i>Connectors</i> .....	<b>8</b>
<i>Switches</i> .....	<b>9</b>
<i>Controls</i> .....	<b>9</b>
<i>Indicators</i> .....	<b>10</b>
<b>VOLTAGE SELECTION AND FUSES</b> .....	<b>10</b>
<b>APPLICATION EXAMPLES</b> .....	<b>11</b>
<i>One Piece PA System</i> .....	<b>11</b>
<i>Basic Sound Reinforcement System With Stage Monitors</i> .....	<b>12</b>
<i>DJ or Sound Reinforcement System with EONSUB G2</i> .....	<b>12</b>
<i>DJ System with Passive Subwoofers</i> .....	<b>13</b>
<b>TROUBLESHOOTING</b> .....	<b>13-15</b>
<b>REFERENCE</b> .....	<b>16</b>
<i>Gain Structure</i> .....	<b>16</b>
<i>Connections - Balanced and Unbalanced</i> .....	<b>17</b>
<i>Loudspeaker Placement and Mounting</i> .....	<b>17</b>
<i>Cables and Connectors</i> .....	<b>18-19</b>
<b>JBL LIMITED WARRANTY &amp; CONTACT INFORMATION</b> .....	<b>20</b>

## Welcome

Welcome to the family of discerning sound equipment users who have selected JBL Professional loudspeakers. EON is a creation of JBL, the world leader in sound reinforcement. JBL sound systems are used in some of the world's most famous arenas, concert halls and clubs. In fact, JBL speakers are the premier choice for today's hottest touring acts and artists. You just can't make a more professional choice. This User Guide contains important information that will help you get the most from your JBL EON loudspeakers so please take a moment to read it and be sure to keep it in a safe place for future reference.

Congratulations and thanks from all of us at JBL Professional. You have invested in the best portable performance system available.

### PACKAGE CONTENTS

Your EON10 G2 system should include the following:

- User Guide
- 1 EON10 G2 speaker
- 1 10' (3 m) IEC Power Cable

### AGENCY APPROVALS AND CERTIFICATIONS

This EON G2 System complies with all International Safety Requirements for Mains Operated Professional audio equipment under IEC65, and Electromagnetic compatibility, Radio interference, Emissions and Immunity requirements.

### BEFORE YOU BEGIN - IMPORTANT INFORMATION

Before using your EON10 G2 speaker system please review the following for important information on safety and protection of your investment in quality loudspeakers:

#### Mounting / Suspending EON Speakers

EON speakers are designed for portable applications in which the speakers will be stacked directly on the floor, stage, speaker stands or a solid, stable platform. Optional accessory items are available from JBL Professional and after-market suppliers to facilitate suspension and wall / ceiling mounting of EON speakers. Only those items recommended by JBL Professional should be used. When using these items, review all enclosed documentation and carefully follow all instructions and safety precautions.

*CAUTION: Suspension of speakers should be done by qualified persons following safe rigging standards and practices. Unsafe mounting or overhead suspension of any heavy load can result in serious injury and equipment damage.*

#### Care and Maintenance

While your EON speakers are rugged and will provide years of service, some common sense care in handling will prevent damage and preserve appearance.

- If your speakers will be frequently moved, consider a padded carrying bag (see AVAILABLE ACCESSORIES).
- If your EON speakers have been subjected to prolonged exposure to extreme low temperatures, avoid subjecting them to heavy mechanical shock and warm the speakers up by playing at a low volume for one hour before playing at loud levels.

- Keep the exterior of the speaker enclosure clean. Make sure to unplug the unit before cleaning. Use a damp rag with a general-purpose household detergent. For grease and marking tape residue, use a damp cloth with isopropyl alcohol or mineral spirits and wipe dry. Do not use powerful solvents like acetone, MEK, lacquer thinner or 1,1,1-Trichloro-ethane (house hold cleaning fluid). These solvents will damage painted and co-polymer surfaces of your speakers.
- EON speakers are not intended for fixed installation in outdoor environments. Moisture can damage the speaker cone and surround, cause corrosion of electrical contacts, and create an electrical shock hazard. Protect your speakers from moisture. Avoid exposing the speakers to direct moisture. Any electrical ly powered device can produce dangerous shock hazards when wet or exposed to moisture. Keep speakers out of extended or intense direct sunlight such as that encountered in permanent, outdoor installation. The driver suspension will prematurely dry out and finished surfaces will be degraded by long-term exposure to intense ultra-violet light.

### Placement Precautions

For Stand Mounting your EON speakers include a 35mm receptacle cup to facilitate mounting on tripod stands. When using stands, be sure to observe the following precautions:

- EON speakers include a thumbscrew that can be tightened to lock the speaker to the tripod stand. Before mounting the speaker on the stand, be sure to loosen the screw so that it doesn't prevent the pole from fully penetrating the socket.
- Check the stand specification to be certain it is designed to support the weight of the speaker (see specifications). Observe all safety precautions specified by the stand manufacturer.
- Always verify that the stand is placed on a flat, level, and stable surface.
- Route cables so that performers, production crew, and audience will not trip over the cables pulling the speaker over.
- Be sure to fully extend the legs of tripod type stands.
- Position the stand so that the legs do not present a trip hazard.
- Do not attempt to place more than one speaker on a stand designed for a single speaker.
- Always be cautious in windy, outdoor conditions. It may be necessary to place additional weight (e.g. sandbags) on the base of the stand to improve stability.

### Floor and Table Top Application

The EON10 G2 generates considerable energy. When placed on a slippery surface such as polished wood or linoleum, the EON10 G2 may move due to its acoustical energy output. Precautions should be taken to ensure that the speaker does not fall off a stage or table on which it is placed. One solution is to place the speaker on a rubber mat.

### Electrical Safety

All EON products are fitted with a detachable power cord (supplied) which connects to the AC mains and the back panel of the loudspeaker. The power cord has an IEC female connector on one end and a male mains connector on the other end. This cord is supplied specifically to accommodate the different world-wide safety and electrical code requirements. Depending on the electrical power standards in your area, the power cord may have a 3-pin type plug. Do not cut off or damage the grounding plug. Like any electrical appliance, your EON powered speakers should not be used in water or when wet.

## About The EON10 G2

### Applications

- Live sound reinforcement, speech and vocals, music playback in entertainment, A/V, and institutional venues-especially when ease of use and portability are important factors.
- Amplification, mixing, and monitoring for electronic musical instruments.

### Features

The second generation of one of the most successful and influential professional speaker systems ever.

- 10" Differential Drive® low-frequency driver with a neodymium magnet for low-distortion and light weight.
- 1" (throat diameter) JBL compression driver with titanium diaphragm and ferro-fluid cooling.
- Bi-amplified 125 watts low frequency and 50 watts high frequency - actual power delivered to the drivers.
- Built-in 3-input mixer. One balanced mic / line selectable input, one dual-channel TRS 1/4" phone line-level
- Balanced loop-through / mix output. "Daisy-chain" additional EON speakers or send the mixed output to a mixing console or auxiliary EON speaker.
- 90° x 60° (nominal) constant directivity horn.
- Thermomaster® Total Thermal Management System®. A single piece, cast-aluminum baffle integrates the woofer frame, horn, and amplifier heat sink. Air movement in the finned ports dissipates heat - no internal or external cooling fans are required.
- Rugged, lightweight, black co-polymer enclosure with an ergonomic molded in handle and cast aluminum baffle.
- Integral 35 mm pole mount receptacle with securing thumbscrew.
- Multi-angle enclosure for front of house or stage monitor application.

### Specifications

Freq. Range (-10 dB):	65 Hz - 18 kHz
Freq. Response (±3 dB):	90 Hz - 16 kHz
Horiz. Coverage (-6 dB):	90° nominal
Vert. Coverage (-6 dB):	60° nominal
Rated Maximum SPL:	117 dB, @ 1 m (3.3 ft)
Dimensions (H x W x D):	493 mm x 356 mm x 307 mm (19.4 in x 14.0 in x 12.1 in.)
Net Weight:	10.4 kg (23 lbs.)
LF Driver:	Integral frame with one 10" (254 mm) driver, dual neodymium magnet, 1.5" Differential-Drive® voice-coil.
HF Driver:	JBL2412 1" (throat diameter) compression driver with titanium diaphragm. Ferro-fluid cooled.
Amplifier Power LF:	125 watts @ low-frequency driver impedance.
Amplifier Power HF:	50 watts @ high-frequency driver impedance.
Input 1 Sensitivity:	-48 dBu to 0 dBu for rated output (Mic/Line switch in MIC position) -6 dBu to +20 dBu for rated output (Mic/Line switch in LINE position)
Input 2 & 3 Sensitivity:	-12 dBu to +20 dBu for rated output
Output Level:	+26 dBu (peak), Loop/Mix switch in MIX position
Audio Connectors Input 1:	XLR/F, balanced
Audio Connectors Input 2 & 3:	Single TRS 1/4" Phone
Crossover Freq:	2.7 kHz
Loop/Mix Out:	XLR/M, balanced.
AC Input:	110 - 230 VAC, 50 - 60 Hz, 100 watts rating per UL, detachable IEC power cable

## Frequency Reponse

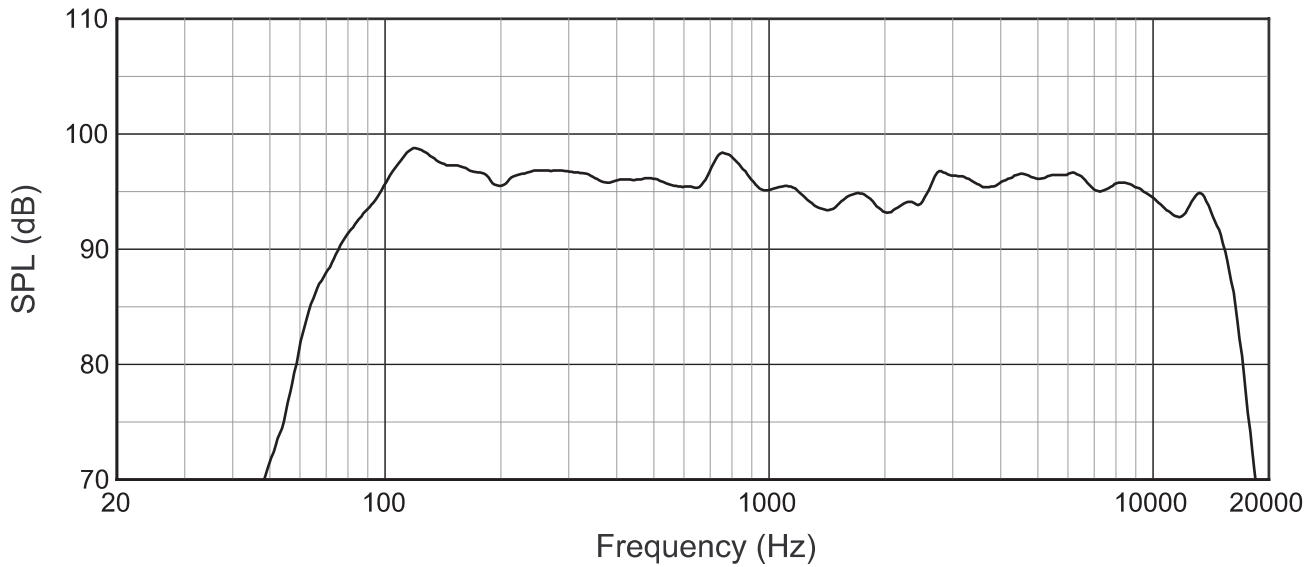

## Available Accessories

SS2-BK	Tripod Stand
ESK10	Suspension Kit for EON 10" models
BRK10	Bracket, adapts EON 10" models to OmniMount® brackets
EON10 Bag-1	Zippered, plush-lined speaker bag for EON 10" models

## Block Diagram

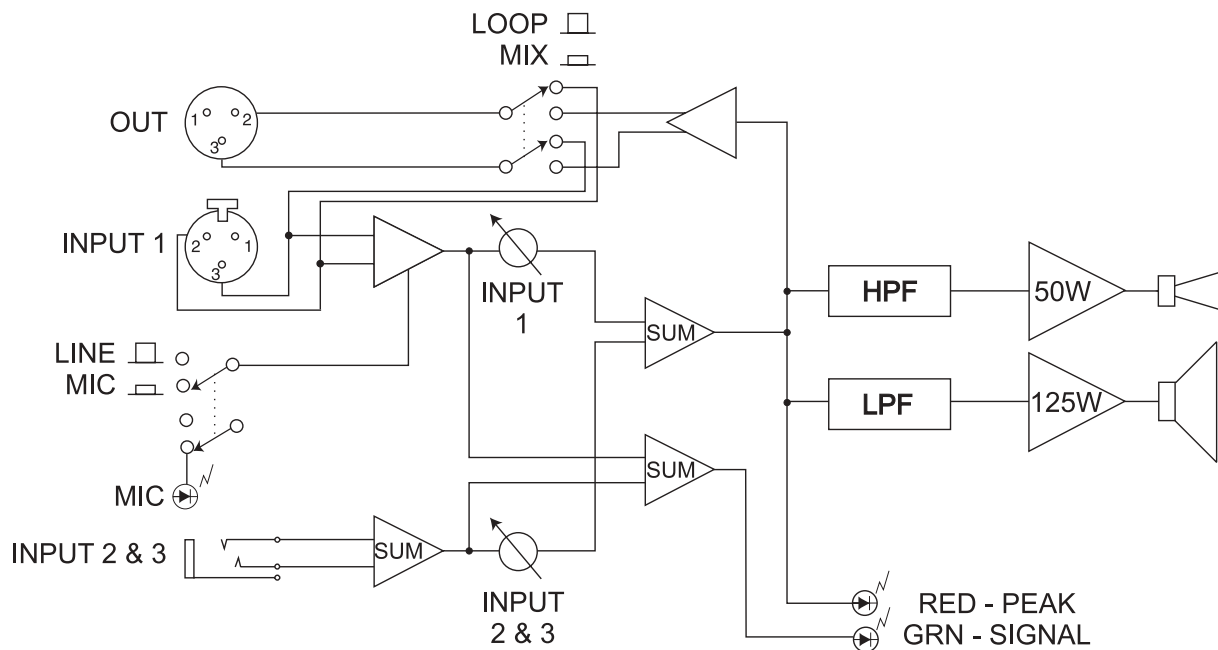

# Quick Start

1. Refer to the "Basic Sound Reinforcement System with Stage Monitors" diagram on page 12
2. Turn the INPUT 1 and INPUT 2 & 3 controls fully counter clockwise.
3. Set the MIC/LINE switch.
  - If a microphone will be connected directly to INPUT 1, set the MIC/LINE switch to the MIC position (depressed). The MIC LED will illuminate when power is turned on.
  - If a mixer, CD player, cassette tape, or electronic musical instrument (the "source") will be connected directly to INPUT 1, set the MIC/LINE switch to the LINE position (disengaged). The MIC LED will not illuminate when power is turned on.
4. Plug the power cable into a properly grounded 3-wire AC power.
5. Plug the XLR cable from the mixer or microphone into the INPUT 1 connector.
6. Connect unbalanced sources (if used) to the INPUT 2 & 3 connector.
7. **POWER UP PROCEDURE**  
 First, switch on the power to the mixer, audio sources, or musical instruments that are feeding your EON10 G2.
  - Next, turn on the power switch (the front panel power indicator will illuminate).
  - Reverse this process when shutting down your system. This will avoid disturbing thumps from the speaker as sources power on/off.
8. **SET VOLUME**
  - If you are using an audio-mixing console, refer to the manufacturer's instructions to properly set gain structure (see the "Gain Structure" section on page 16).
  - Turn up your sources to the level that will be used in performance and talk, sing or play into the system.
  - Bring the INPUT 1 control up (clockwise) until the desired volume has been reached. If you are using a microphone, turn the INPUT 1 control up slowly to avoid feedback.
  - If you are using the INPUT 2 & 3 inputs, bring the INPUT 2 & 3 controls up to the desired volume.
9. **CHECK THE PEAK LED** - The PEAK indicator flashes when the loudspeaker's on-board amplifiers are approaching maximum output. Occasional flashes are normal for very loud operation. However, if the PEAK LED stays illuminated, the sound will be distorted and it is an indication that more speakers or a lower performance volume may be required for your specific application.

## CONTROLS AND CONNECTIONS

The audio section of the EON10 G2 includes powerful features that enhance the flexibility of your speakers.

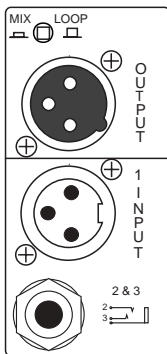

### Controls

#### INPUT 1

Adjusts the level of INPUT 1. Use this control to match the input sensitivity of the EON10 G2 to the output level of the mixer, microphone, or instrument connected to INPUT 1. It is a common misconception that this control changes the power of a system. Your EON10 G2 will produce its rated output power no matter where this control is set. The INPUT 1 control determines how much signal is required at the input in order to drive the system to full output.

#### INPUT 2 & 3

This control adjusts the level of the inputs connected to INPUT 2 & 3.

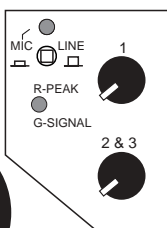



## Connectors

### INPUT 1

This balanced input accepts a standard XLR (female) connector. A broad range of signals from microphones (-48 dBu to 0 dBu nominal), audio mixing consoles, and electronic musical instruments may be connected here. When using a single audio input to the speaker, this is the input to use. The sensitivity of this input is controlled by the MIC/LINE SWITCH and the INPUT 1 rotary control.

### INPUT 2 & 3

This 1/4" jack can accommodate one or two channels of audio. When a two-channel source is connected by means of a TRS 1/4" plug, both channels are summed to mono. A single channel source may also be connected here with a standard 1/4" TS plug. This input is intended for use with audio devices including cassette tape, CD, MP3 players, computer sound-card outputs, electronic keyboards, and electric/acoustic musical instruments. The level of INPUTS 2 & 3 is controlled by the INPUT 2 & 3 rotary control. See the APPLICATION EXAMPLES and CABLES AND CONNECTORS sections of this guide for details on how this input may be used.

### OUT

This XLR (male) output connector works with the MIX/LOOP SWITCH (see below) to provide a method of sending audio from your EON10 G2.

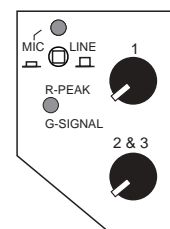
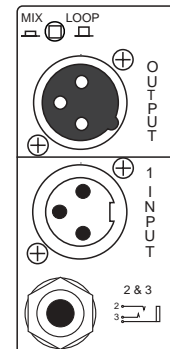

## Switches

### MIC/LINE

The MIC/LINE switch effects only INPUT 1. It selects between two sensitivity ranges. This switch is used to match the input sensitivity of the EON10 G2 with the output level of the device connected to INPUT 1. Depressing the MIC/LINE switch selects MIC (most sensitive) and causes the MIC/LINE LED to illuminate.

*CAUTION: Before adjusting this switch, be certain to rotate the INPUT 1 control fully counter clockwise. After the MIC/LINE switch has been adjusted, slowly rotate the INPUT 1 control clockwise until the desired volume has been reached.*

- Use the MIC position (depressed) when a microphone is connected to INPUT 1.
- Use the LINE position (disengaged) when a line level source such as an audio mixing console, audio playback device, or electronic musical instrument is connected to INPUT 1.

### MIX/LOOP

This switch selects the source of the signal for the OUT connector.

*CAUTION: Before adjusting this switch, be certain to set the input level control of any equipment connected to this output to its minimum gain (least sensitive) setting.*

- In the disengaged position, only the signal from the INPUT 1 connector is routed directly to the OUT connector. Changing the other settings on the audio panel will not effect the OUT signal. The INPUT 2 & 3 inputs will not be present at the OUT connector. Use this setting when you want to feed multiple EON powered speakers the same signal.
- In the MIX position (depressed), a blend of all inputs to the speaker (INPUT 1 and 2 & 3) will be sent to the OUT connector. Any changes to input level settings will affect the OUT signal. See the APPLICATION EXAMPLES section for details on how this mode may be used.

**Indicators**

**PEAK / SIGNAL**

The PEAK / SIGNAL LED (Light Emitting Diode) is a two-color device. Red indicates that the system is approaching clipping. The threshold for this light is actually about 2 dB below clipping. An occasional flicker of the red LED on the loudest peaks is acceptable. If this LED remains red for more than the duration of brief dynamic peaks, the system is being overdriven. Continuously over driving the system will result in unpleasant and fatiguing distortion and may lead to premature failure of your speaker system.

If the red LED illuminates excessively:

- Reduce INPUT 1 and INPUT 2 & 3.
- Reduce the output level of the mixer, musical instrument, or other source to the speaker.

Green indicates a usable signal is present at INPUT 1 and/or INPUT 2 & 3.

**MIC**

This LED illuminates to indicate that the MIC/LINE switch is in the MIC (depressed) position.

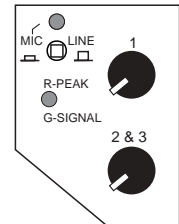
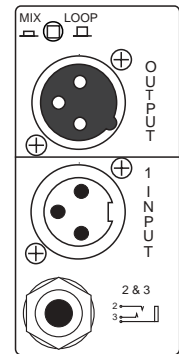

**VOLTAGE SELECTION AND FUSES**

**Changing Voltage**

Your EON10 G2 will typically be set at the factory to accommodate the power mains voltage in your area. Before you set up your EON10 G2 for the first time it is a good idea to verify that the setting of the selector is appropriate for the power in your area. Directly above the power switch you will see a seal that indicates the factory setting for the voltage. If the voltage indicated is correct for your area, go ahead and power up your EON10 G2.

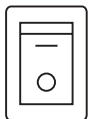

In the event that you do need to change the voltage selection:

- Make sure that the AC is disconnected from the speaker.
- Directly above the power switch on the speaker is a voltage selector. Peel off the factory-applied seal.
- Set the voltage selector switch to the 115V or 230V setting as required for your area.
- After having reconfirmed that the correct voltage is selected, connect the AC (IEC connector) and power the unit up.

**DO NOT UNDER ANY CIRCUMSTANCES OPERATE THE UNIT WITH THE WRONG VOLTAGE SELECTED. DOING SO MAY RESULT IN SERIOUS DAMAGE TO YOUR SPEAKER SYSTEM WHICH WILL NOT BE COVERED BY WARRANTY.**

**Fuse Replacement**

The EON10 G2 has no user-serviceable fuses. Failure of fuses is most frequently a symptom of problems requiring service by a competent technician.

# Application Examples

## One Piece PA System

In this basic PA setup a dynamic microphone is connected to INPUT 1. The MIC / LINE switch would be set to the MIC position (depressed). Several examples illustrating possible uses for INPUT 2 & 3 are shown.

**Acoustic Electric Guitar** - The mono or stereo output of an electrified acoustic guitar can be connected directly to INPUT 2 & 3. If a stereo instrument and cable are used, the left and right channels will be combined into mono.

**Electronic Keyboards** - A pair of electronic keyboards are connected to INPUT 2 & 3 via an adapter cable (see the section "Cables and Connectors"). Such a cable is available from pro-audio dealers and is commonly used as an "insert cable".

**Portable CD Player** - A portable CD player may be connected to the EON10 G2 by means of a 1/4" TRS to Mini-Phone adapter. Again, the left and right channels will be combined into mono.

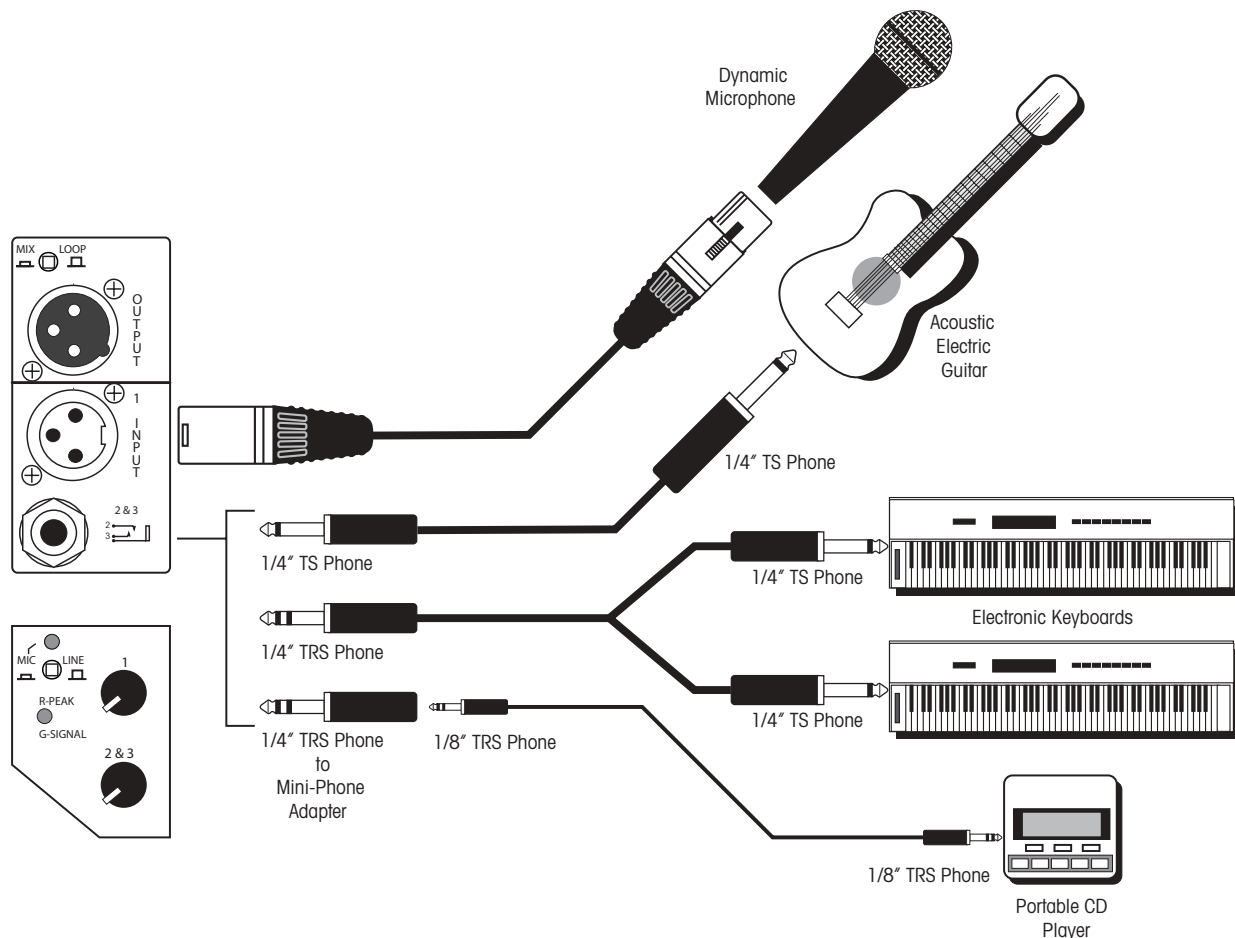

### Basic Sound Reinforcement System With Stage Monitors

This is the basic live sound system. The optional tripod stands will get the speakers up above the audience so the sound can project. The second pair of EON10 G2 speakers are used as stage monitors. For maximum gain before feedback, position the monitors so that they do not point into microphones.

The output connectors on your mixer may differ from the illustration.

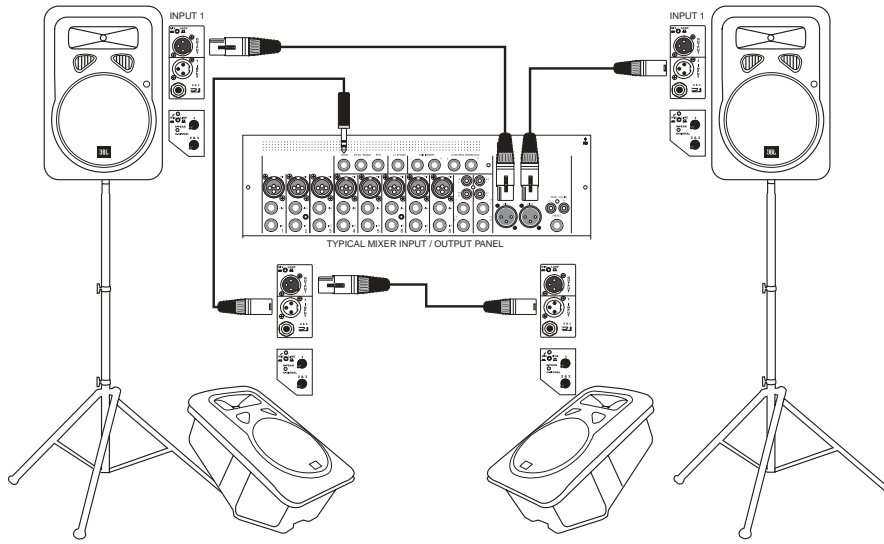

### DJ or Sound Reinforcement System with EONSUB G2

Here's a system with EONSUB G2 added to provide additional low-frequency power. If your mixer has a SUM or MONO output, you can also drive the EONSUB G2 from this output and use the SUM or MONO volume control for independent control of bass.

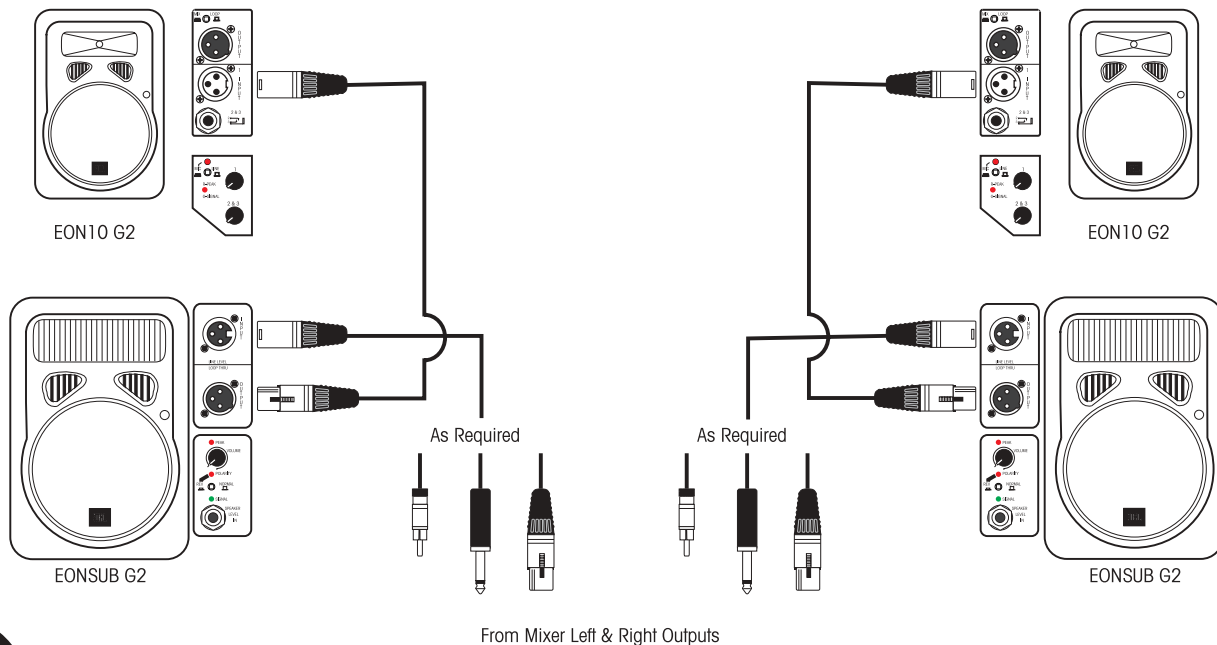

## DJ System with Passive Subwoofers

This system combines a pair of EON10 G2 powered speakers with externally powered subwoofers for extra power at very low frequencies.

\* Recommended crossover frequency = 80-150 Hz. (season to taste)

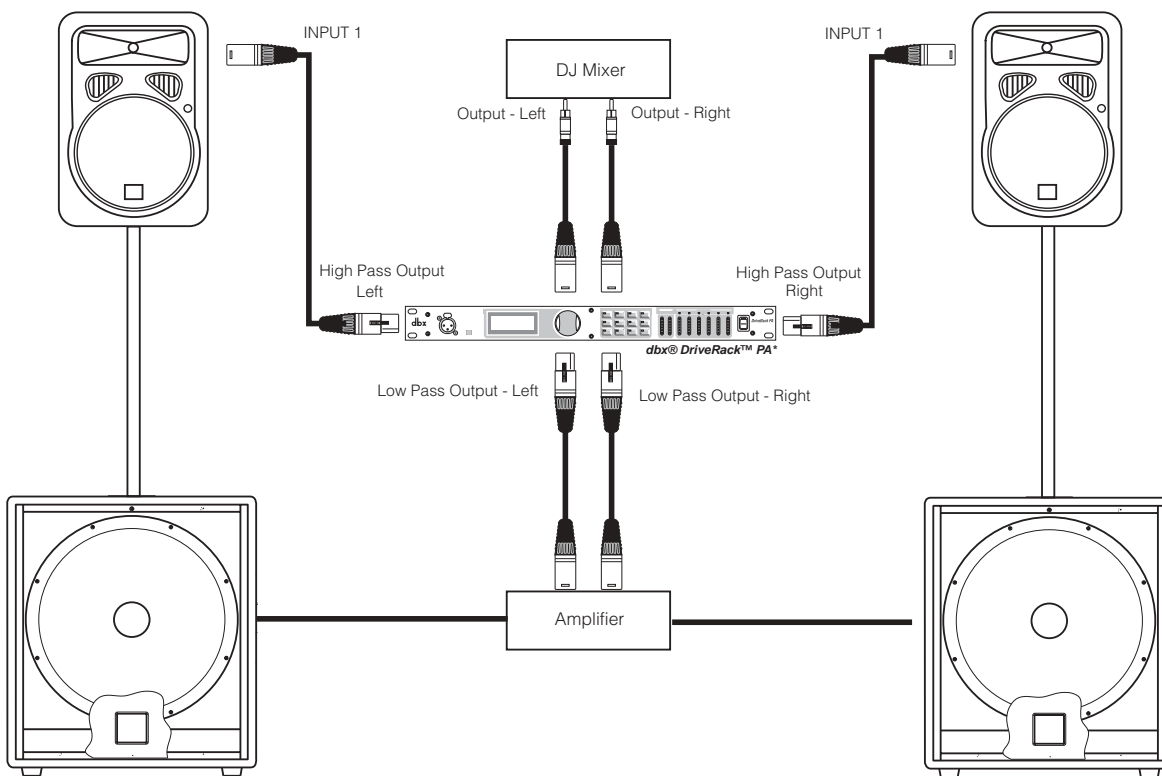

## Troubleshooting

Symptom	Likely Cause	What to do
No sound	Speaker not connected to active AC power.	Verify that speaker is connected and that the circuit is on.
	Power not switched on.	Switch on power and verify that power LED is on.
No sound, speaker is connected to working AC power but won't come on.	Speaker power cable is faulty or improperly connected.	Re-seat the power cable at both ends. Substitute a known-good power cable
	Blown fuse.	There are no user-serviceable fuses in the EON10 G2. Take your speaker to a competent servicer.

## Troubleshooting

Symptom	Likely Cause	What to do
No sound. Speaker comes on. SIGNAL LED does not illuminate.	Signal source (mixer, instrument, etc.) is not sending.	Check VU meters on the source mixer. Verify that the tape or CD is playing. Use headphones to verify that the instrument is actually sending an audio signal.
	Faulty cables and connections.	Disconnect and re-seat signal cables. Replace suspected cable with a known-good cable.
No sound with microphone connected directly to the MIC / LINE 1 input. SIGNAL LED does not illuminate.	Microphone requires phantom power.	The EON10 G2 does not supply phantom power. Switch to a dynamic microphone, use a battery in the microphone (if possible), use an external phantom power supply.
Signal sounds distorted and very loud, PEAK light is lit most of the time.	Excessive input signal, exceeding the capabilities of the speakers.	Reduce the output level of the source. Turn down the LEVEL controls on the speaker. Use additional EON speakers.
Signal sounds distorted even at moderate volumes, PEAK light is not lit.	Mixer or other source is overdriven.	Review the Owner's Manual for your mixer and adjust controls as needed. <ul style="list-style-type: none"> <li>• Input sensitivity (gain)</li> <li>• Channel faders</li> <li>• Master faders</li> </ul> Once this is done, review the instructions in the Quick Start section of this guide.
Lots of hiss in the sound, the mixer controls are at very low settings.	Improper gain structure or noisy source device.	Make sure that the MIC/LINE switch is in the LINE (disengaged) position. Reduce the LEVEL settings at the speaker. Review the Owner's Manual for your mixer and adjust controls as needed.
Noise or hiss heard at output.	Noisy source device.	Disconnect the devices that are connected to your speaker one at a time. If the noise goes away, the problem is with the source or the connecting cable.

Symptom	Likely Cause	What to do
Hum or Buzz that increases or decreases when the mixer level controls are moved.	Improper A/C ground or faulty equipment connected to mixer input.	Disconnect or mute channels one at a time to isolate the problem. Refer to the Owner's Manual of the faulty equipment for troubleshooting help.
	Faulty cable between source equipment and mixer.	Substitute a known-good cable for the suspected faulty cable.
Hum or Buzz.	Improper A/C grounding, ground loops.	Connect all speakers to a common power circuit. "Telescope" the audio ground by using an XLR/F to XLR/M adapter with Pin 1 disconnected. Re-route audio cables away from AC power and lighting cables.
	Excessively long unbalanced cable run.	Use the balanced outputs (if available) of your mixer or source equipment to drive your EON speakers. Use a "DI" (direct injection) box to convert your unbalanced equipment output to a balanced output.
	Improper system gain structure.	Reduce the INPUT 1, LINE 2, and LINE 3 controls and increase the output level of your source devices.
The inputs from INPUT 2 & 3 aren't coming out of the OUT connector.	MIX/LOOP SWITCH set improperly.	Set the MIX/LOOP SWITCH to the MIX OUT position (depressed). See the CAUTION in the "Switches" section of this manual.
The speaker connected to the OUT connector goes up and down in volume when I adjust the INPUT 1 control on the 1st speaker.	MIX/LOOP SWITCH set improperly.	Disengage the MIX OUT switch. See the CAUTION in the "Switches" section of this manual.
Speakers feedback and howl when the microphone volume is turned up.	Microphones are pointed into the speakers.	Move the speakers so they do not point into the microphone's pick-up pattern. See the section on "Loudspeaker Placement and Mounting" on page 20.
	Equalizer settings are incorrect.	Locate the feedback frequency and reduce it using the mixer EQ or an external equalizer.
	Excessive gain.	Reduce the gain at the mixer and move the microphone closer to the sound source.

## Reference

### Gain Structure

Gain structure is the term we apply to adjusting the relative input sensitivity and output levels of components in an audio system. The objective of proper gain structure is to minimize noise on one extreme and to prevent clipping on the other. Proper gain structure will result in all components clipping at about the same time.

First, let's clear up one common misconception. The input control on an amplifier or powered speaker does not determine how much power it will produce. A 100 watt amplifier (for example) can produce 100 watts no matter where the input level control is set. The input level control simply determines how much input voltage is required to drive the amp to full output. If the input level controls of an EON10 G2 are set too low (rotated too far counter-clockwise) the mixer will go into clipping before the speakers are driven to full output. If the input level controls of an EON10 G2 are set too high (rotated too far clockwise) the system will be noisy. With that in mind, here's a procedure for setting up system gain structure that will get the best dynamic performance possible from your system.

#### Summary

- Adjust your mixer so that the loudest passages of your performance drive the mixer almost to its peak output.
- Set the MIC / LINE switch to the LINE position (unless a microphone is connected directly to the EON input). Slowly bring up the INPUT 1 level control of the EON10 G2 until the desired performance volume is reached. When used with a typical DJ or audio mixer, this will probably place the control around 10:00 o'clock.

#### Step by step instructions

1. Begin with all level controls on your mixer and EON10 G2 speakers at minimum. Note that the EON10 G2 has a switch that selects "Mic" or "Line" sensitivity. The "Mic" position should be used only when a microphone is connected directly to the input.
2. Bring the INPUT 1 level control on your EON10 G2s to approximately 9:00 o'clock. We'll come back and make some final adjustments here later on.
3. Bring the output of any electronic source (CD player, drum machine, electronic keyboard, etc.) to its "nominal" position. This will usually be marked. If it isn't, bring the control to about 2/3 of its maximum position. Make sure that any foot pedals or other volume controls are at the position they will be during the performance.
4. At your mixer, bring the "Input Attenuator" (sometimes called "Gain" or "Sensitivity") control up while playing the instrument or talking / singing into the microphone. Be sure that the level you're playing at is the same as the actual performance level will be. Watch the channel "Clip" or "Overload" or "Peak" indicator. It should just flicker on the very loudest dynamic peaks.
5. Now bring the channel fader up to its "nominal" position (see the mixer Owners Manual).
6. Slowly bring the mixer master faders up to their nominal position. At this point, you should hear sound from the EON10 G2s. If the level is too high, trim back the INPUT 1 control on the EON10 G2s.
7. Repeat steps 3 – 5 for all remaining channels.
8. Check the meters on the mixer output. If you're seeing peaks that drive the meters into clipping, trim back the channel faders and master faders slightly. Also be aware that actual performance levels tend to be higher than rehearsal and sound check levels so you may want to trim back the input sensitivity slightly.
9. If an outboard processor such as a graphic EQ is used, it should be set to "unity gain" (see the processor's Owners Manual). Unity gain means that the signal level on the output is the same as the level at the input.
10. Now bring up the input control of your EON10 G2 speakers until the desired performance volume is reached. If clipping occurs before the desired volume is reached you need more speakers or a lower performance volume.
11. Listen to your mix and adjust to taste.
12. At this point, the maximum output of the mixing console should be capable of driving your EON10 G2s to full output and you will have the lowest noise operation that your equipment is capable of delivering.



## Connections - Balanced and Unbalanced

There are two basic types of audio system interconnections for very low to medium level audio signals: Balanced and unbalanced. Your EON10 G2 can accept either type of input.

### Balanced Lines

In audio, a balanced line is a three-conductor system in which the two signal wires carry an equal, but opposite voltage with respect to the ground wire. The ground wire acts only as a shield and does not carry any audio signal current. Outside interference (such as RFI – Radio Frequency Interference) is either shielded from the internal signal conductor, or if it gets into the cable, is cancelled out by the opposite signals at the receiving end. Balanced connections are preferred for any longer cable runs.

### Unbalanced Lines

Unbalanced cable is a two-wire system where the shield (ground wire) acts as one of the current carrying signal conductors. The center conductor enclosed by the shield is commonly known as the “hot” conductor. Unbalanced audio cables do not reject noise as well as balanced lines. Unbalanced lines are typical in home hi-fi type systems and on the outputs of electronic musical instruments. These work well if the distance between the components is short, the signal level is relatively high and all of the electronics used in the system are plugged into the same AC service.

### Unbalanced Sources to EON Powered Loudspeakers

If you need to connect your EON speakers to an unbalanced source you have two options:

- Use the INPUT 2 and INPUT 3 connectors. These inputs are balanced but will accept unbalanced inputs without the need for any special adapters.
- Use an adapter or special cable (see the section “Cables and Connectors”).

## Loudspeaker Placement and Mounting

The following guidelines will help you achieve optimum sound wherever you use your EON loudspeakers:

Raise the speakers as high as possible. For best results try to get the high frequency horn at least 2 to 4 feet above the heads of the audience. If the speakers are too low, the people in the back of the audience will not receive the best quality of sound.

Place the speakers between the microphones and the audience. Feedback occurs when the microphones pick up sound from the speakers and “feed” the sound back through the sound system. If space is limited, point the speakers away from the microphones to reduce feedback.

Locate the speakers away from turntables. Low-frequency feedback occurs when the output of the speaker is picked up by the tone arm of the turntable and is re-amplified. A heavy, solid turntable base and shock mounting can also reduce this type of feedback in DJ applications.

Use more speakers in large or highly reverberant spaces. Spreading speakers throughout these spaces will produce much better sound than trying to compensate with loudness level or equalization. For very long distances, the use of another set of speakers on a delay is recommended.

Stand speakers upright for PA - Tilt the speakers back for stage monitoring. Upright stance provides even coverage over a wide area. EON speakers are also designed with two slanted positions for stage monitoring applications.

## Cables and Connectors

XLR/F to XLR/M Microphone Cable	<ul style="list-style-type: none"> <li>• The standard cable for interconnection of microphone and line level signal in professional audio systems.</li> <li>• Microphone to mixer</li> <li>• Microphone to EON10 G2 INPUT 1</li> <li>• Audio mixer to EON10 G2 INPUT 1</li> <li>• "Daisy chaining" EON10 G2 speaker systems</li> </ul>
TRS* (Balanced) 1/4" Phone to XLR/M	<ul style="list-style-type: none"> <li>• For connecting balanced devices with 1/4" connector to the EON speaker</li> </ul>
XLR input. TS (Unbalanced) 1/4" Phone XLR/M	<ul style="list-style-type: none"> <li>• Connects devices such as electronic instruments and some mixers to an XLR input. This cable may be used to connect an unbalanced source to a balanced input but the connection will be unbalanced.</li> </ul>
XLR/M to RCA (phono) cable	<ul style="list-style-type: none"> <li>• Connects consumer audio products and some DJ mixer outputs to professional audio equipment inputs.</li> </ul>
TS (Unbalanced) 1/4" Phone to RCA (phono) cable	<ul style="list-style-type: none"> <li>• Connects outputs of consumer audio equipment to unbalanced line inputs of EON10 G2 and many mixers.</li> <li>• Connects unbalanced line outputs of many mixers to the inputs of consumer audio recorder.</li> </ul>
TRS 1/4" Phone to dual 1/4" Phone	<ul style="list-style-type: none"> <li>• Splits a stereo output into separate left/right signals.</li> <li>• Connects stereo electric guitar to two unbalanced audio inputs.</li> <li>• Connects a headphone output to two unbalanced audio inputs.</li> <li>• Change to a TRS mini-phone to connect to the output of portable CD players and computer sound cards to a mixer or powered speakers.</li> <li>• Also used to connect signal processors to the "insert" of many mixing consoles.</li> </ul>
TRS 1/8" Phone to dual 1/4" Phone	<ul style="list-style-type: none"> <li>• Splits a stereo output from a portable audio device (CD, R-DAT, Mini-Disc, etc.) or computer sound card into separate left/right signals that can be fed to 1/4" inputs of professional audio equipment.</li> </ul>
TRS 1/8" Phone to dual RCA	<ul style="list-style-type: none"> <li>• Splits a stereo output from a portable audio device (CD, R-DAT, Mini-Disc, etc.) or computer sound card into separate left/right signals that can be fed into RCA inputs of audio equipment.</li> </ul>
1/4" Phone to RCA (phono) Adapter	<ul style="list-style-type: none"> <li>• Used to connect outputs of consumer audio products to the unbalanced inputs of many pro-audio devices.</li> </ul>
TRS 1/4" Phone to 1/8" Mini-Phone Adapter	<ul style="list-style-type: none"> <li>• Used to connect headphones with Mini-Phone cables to 1/4" headphone jacks.</li> <li>• Adapts the output of portable audio players and computers to INPUT 2 &amp; 3 on the EON10 G2.</li> </ul>

\*TRS = Tip Ring Sleeve indicating that the connector can conduct two audio channels (via the Tip and the Ring) and a ground (via the Sleeve). TRS connectors may be used for a single channel of balanced audio or two channels of unbalanced audio.

XLR/F to XLR/M Microphone Cable

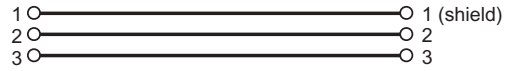

TRS (Balanced) 1/4" Phone to XLR/M Cable



TS (Unbalanced) 1/4" Phone to XLR/M Cable

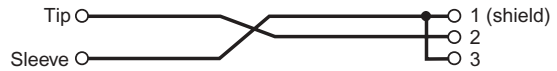

XLR/M to RCA (phono) Cable



TS (Unbalanced) 1/4" Phone to RCA (phono) Cable



TRS 1/4" Phone to dual TS 1/4" Phone

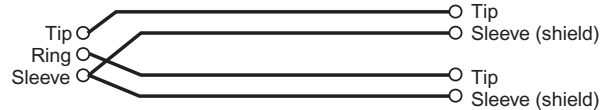

TRS 1/8" Mini-Phone to dual TS 1/4" Phone

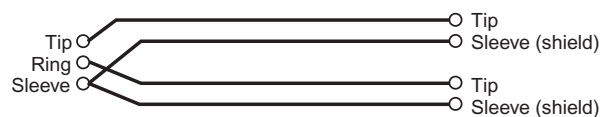

TRS 1/8" Mini-Phone to RCA (phono) Adapter

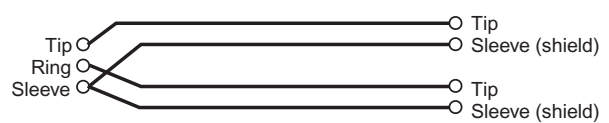

1/4" Phone to RCA (phono) Adapter

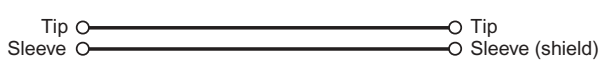

TRS 1/4" Phone to 1/8" Mini-Phone Adapter

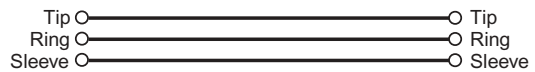

# JBL Limited Warranty

## Who Is Protected by This Warranty?

Your JBL Warranty protects the original owner and all subsequent owners so long as: A.) Your JBL product has been purchased in the Continental United States, Hawaii or Alaska. (This Warranty does not apply to JBL products purchased elsewhere except for purchases by military outlets. Other purchasers should contact the local JBL distributor for warranty information.); and B.) The original dated bill of sale is presented whenever warranty service is required. The JBL Limited Warranty on professional loudspeaker products (except for enclosures) remains in effect for five years from the date of the first consumer purchase. JBL amplifiers are warranted for three years from the date of original purchase. Enclosures and all other JBL products are warranted for two years from the date of original purchase.

## What does the JBL Warranty cover?

Except as specified below, your JBL Warranty covers all defects in material and workmanship. The following are not covered: Damage caused by accident, misuse, abuse, product modification or neglect; damage occurring during shipment; damage resulting from failure to follow instructions contained in your Instruction Manual; damage resulting from the performance of repairs by someone not authorized by JBL; claims based upon any misrepresentations by the seller; any JBL product on which the serial number has been defaced, modified or removed.

## Who Pays for What?

JBL will pay all labor and material expenses for all repairs covered by this warranty. Please be sure to save the original shipping cartons because a charge will be made if replacement cartons are requested. Payment of shipping charges is discussed in the next section of this warranty.

## How to Obtain Warranty Performance?

If your JBL product ever needs service, write or telephone us at JBL Incorporated (Attn: Customer Service Department), 8500 Balboa Boulevard, PO. Box 2200, Northridge, California 91329 (818/893-8411). We may direct you to an authorized JBL Service Agency or ask you to send your unit to the factory for repair. Either way, you'll need to present the original bill of sale to establish the date of purchase. Please do not ship your JBL product to the factory without prior authorization.

If transportation of your JBL product presents any unusual difficulties, please advise us and we may make special arrangements with you. Otherwise, you are responsible for transporting your product for repair or arranging for its transportation and for payment of any initial shipping charges. However, we will pay the return shipping charges if repairs are covered by the warranty.

# Contact Information

## Mailing Address:

JBL Professional  
8500 Balboa Blvd.  
Northridge, CA 91329

## Shipping Address:

JBL Professional  
8370 Balboa Blvd., Dock D  
Northridge, CA 91329

## Customer Service:

Monday through Friday  
8:00am - 5:00pm  
Pacific Coast Time In the U.S.A.  
(800) 8JBLPRO (800.852.5776)  
[www.jblproservice.com](http://www.jblproservice.com)

## On the World Wide Web:

[www.jblpro.com](http://www.jblpro.com)

## Outside the USA:

Contact the JBL Professional Distributor in your area. A complete list of JBL Professional international distributors is provided at our U.S.A. website - [www.jblpro.com](http://www.jblpro.com)

## Customer Registration:

Register online at [www.jblpro.com/registration](http://www.jblpro.com/registration)



**H** A Harman International Company



## Free Manuals Download Website

<http://myh66.com>

<http://usermanuals.us>

<http://www.somanuals.com>

<http://www.4manuals.cc>

<http://www.manual-lib.com>

<http://www.404manual.com>

<http://www.luxmanual.com>

<http://aubethermostatmanual.com>

Golf course search by state

<http://golfingnear.com>

Email search by domain

<http://emailbydomain.com>

Auto manuals search

<http://auto.somanuals.com>

TV manuals search

<http://tv.somanuals.com>