

OWNER'S GUIDE

PRODUCT LINE: STUDIO SERIES

MODEL NUMBER: S412P

DESIGN GOAL: Bring the thrill of live performance and movie sound to the home environment by calling on JBL's professional engineering leadership.

TWEETER TYPE: Pure-titanium dome with EOS™ waveguide

WOOFER TYPE: Cast-aluminum basket with HeatScape™ motor structure

CROSSOVER NETWORK: Straight-Line Signal Path™ (SSP)

PORT DESIGN: FreeFlow™ flared

PROFESSIONAL REFERENCE: Studio Monitor

JBL

READ THIS! Important Safety Precautions!

CAUTION

RISK OF ELECTRIC SHOCK DO NOT OPEN

CAUTION: To prevent electric shock, do not remove the grounding plug on the power cord, or use any plug or extension cord that does not have a grounding plug provided.

Make certain that the AC outlet is properly grounded. Do not use an adapter plug with this product.



The lightning flash with arrowhead symbol, within an equilateral triangle, is intended to alert the user to the presence of uninsulated "dangerous voltage" within the product's enclosure that may be of sufficient magnitude to constitute a risk of electric shock to persons.



The exclamation point within an equilateral triangle is intended to alert the user to the presence of important operating and maintenance (servicing) instructions in the literature accompanying the appliance.

- 1. Read Instructions.** All the safety and operating instructions should be read before the product is operated.
- 2. Retain Instructions.** The safety and operating instructions should be retained for future reference.
- 3. Heed Warnings.** All warnings on the product and in the operating instructions should be adhered to.
- 4. Follow Instructions.** All operating and use instructions should be followed.
- 5. Cleaning.** Unplug this product from the wall outlet before cleaning. Do not use liquid cleaners or aerosol cleaners. Use a damp cloth for cleaning.
- 6. Attachments.** Do not use attachments not recommended by the product manufacturer, as they may cause hazards.
- 7. Water and Moisture.** Do not use this product near water – for example, near a bathtub, wash bowl, kitchen sink or laundry tub; in a wet basement; or near a swimming pool; and the like.
- 8. Accessories.** Do not place this product on an unstable cart, stand, tripod, bracket, or table. The product may fall, causing serious injury to a child or adult, and serious damage to the product. Use only with a cart, stand, tripod, bracket, or table recommended by the manufacturer, or sold with the product. Any mounting of the product should follow the manufacturer's instructions, and should use a mounting accessory recommended by the manufacturer.
- 9. A Product and Cart Combination Should Be Moved with Care.** Quick stops, excessive force, and uneven surfaces may cause the product and cart combination to overturn.
- 10. Ventilation.** Slots and openings in the cabinet are provided for ventilation and to ensure reliable operation of the product and to protect it from overheating, and these openings must not be blocked or covered. The openings should never be blocked by placing the product on a bed, sofa, rug, or other similar surface. This product should not be placed in a built-in installation such as a bookcase or rack unless proper ventilation is provided or the manufacturer's instructions have been adhered to.

11. Power Sources. This product should be operated only from the type of power source indicated on the marking label. If you are not sure of the type of power supply to your home, consult your product dealer or local power company. For products intended to operate from battery power, or other sources, refer to the operating instructions.

12. Grounding or Polarization. This product may be equipped with a polarized alternating-current line plug (a plug having one blade wider than the other). This plug will fit into the power outlet only one way. This is a safety feature. If you are unable to insert the plug fully into the outlet, try reversing the plug. If the plug should still fail to fit, contact your electrician to replace your obsolete outlet. Do not defeat the safety purpose of the polarized plug.

13. Power-Cord Protection. Power-supply cords should be routed so that they are not likely to be walked on or pinched by items placed upon or against them, paying particular attention to cords at plugs, convenience receptacles, and the point where they exit from the product.

14. Nonuse Periods. The power cord of the product should be unplugged from the outlet when left unused for long periods of time.

15. Outdoor Antenna Grounding. If an outside antenna or cable system is connected to the product, be sure the antenna or cable system is grounded so as to provide some protection against voltage surges and built-up static charges. Article 810 of the National Electrical Code, ANSI/NFPA 70, provides information with regard to proper grounding of the mast and supporting structure, grounding of the lead-in wire to an antenna discharge unit, size of grounding conductors, location of antenna-discharge unit, connection to grounding electrodes, and requirements for the grounding electrode. See Figure 1.

16. Lightning. For added protection for this product during a lightning storm, or when it is left unattended and unused for long periods of time, unplug it from the wall outlet and disconnect the antenna or cable system. This will prevent damage to the product due to lightning and power-line surges.

17. Power Lines. An outside antenna system should not be located in the vicinity of overhead power lines or other electric light or power circuits, or where it can fall into such power lines or circuits. When installing an outside antenna system, extreme care should be taken to keep from touching such power lines or circuits, as contact with them might be fatal.

18. Overloading. Do not overload wall outlets, extension cords, or integral convenience receptacles, as this can result in a risk of fire or electric shock.

19. Object and Liquid Entry. Never push objects of any kind into this product through openings, as they may touch dangerous voltage points or short-out parts that could result in a fire or electric shock. Never spill liquid of any kind on the product.

20. Servicing. Do not attempt to service this product yourself, as opening or removing covers may expose you to dangerous voltage or other hazards. Refer all servicing to qualified service personnel.

21. Damage Requiring Service. Unplug this product from the wall outlet and refer servicing to qualified service personnel under the following conditions:

- a. The power-supply cord or the plug has been damaged; or
- b. Objects have fallen onto, or liquid has been spilled into, the product; or
- c. The product has been exposed to rain or water; or
- d. The product does not operate normally when following the operating instructions. Adjust only those controls that are covered by the operating instructions, as an improper adjustment of other controls may result in damage and will often require extensive work by a qualified technician to restore the product to its normal operation; or
- e. The product has been dropped or damaged in any way; or
- f. The product exhibits a distinct change in performance – this indicates a need for service.

22. Replacement Parts. When replacement parts are required, be sure the service technician has used replacement parts specified by the manufacturer or that have the same characteristics as the original part. Unauthorized substitutions may result in fire, electric shock or other hazards.

23. Safety Check. Upon completion of any service or repairs to this product, ask the service technician to perform safety checks to determine that the product is in proper operating condition.

24. Wall or Ceiling Mounting. The product should be mounted to a wall or ceiling only as recommended by the manufacturer.

25. Heat. The product should be situated away from heat sources such as radiators, heat registers, stoves, or other products (including amplifiers) that produce heat.

Figure 1.
Example of Antenna
Grounding as per National
Electrical Code, ANSI/NFPA 70

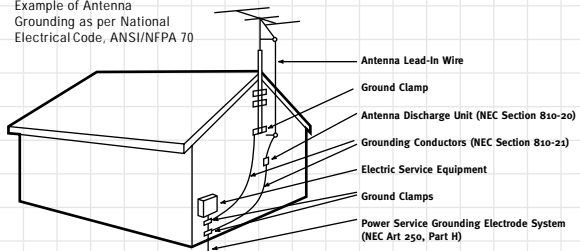

Part No. JBLULB 6/96

THANK YOU FOR CHOOSING JBL

For more than 50 years, JBL has been involved in every aspect of music and film recording and reproduction, from live performances to the recordings you play in your home, car or office.

We're confident that the JBL loudspeakers you have chosen will provide every note of enjoyment

that you expected – and that when you think about purchasing additional audio equipment for your home, car or office, you will once again choose JBL.

Please take a moment to complete the enclosed profile card. It enables us to keep you posted on our latest advancements, and

helps us to better understand our customers and build products that meet their needs and expectations.

JBL Consumer Products

SPEAKER PLACEMENT

Proper placement of the speakers is an important step in obtaining the most realistic sound-stage possible. These recommendations are for

the optimum placement of the loudspeakers. Use them as a guide. Slight variations will not diminish your listening pleasure. All of the Studio Series

loudspeakers are video-shielded and can safely be placed near a television.

MODEL: S412P

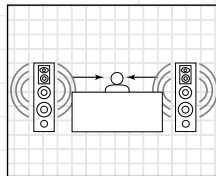
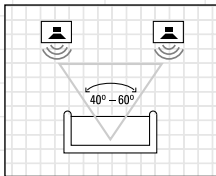

Without pad

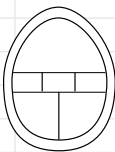

With pad

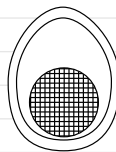

This model is shipped with four self-adhesive nonskid pads that are to be used if the loudspeaker is placed on a smooth-surfaced floor, such as tile or hardwood. Gently lay the speaker on its side (not its front or back) on a soft,

nonabrasive surface. Attach each pad to the bottom of its foot in the widest portion of the recessed area. DO NOT attach the pads if the speaker will be placed on carpeting.

NEVER drag the speaker to move it, as this will damage the pads, the feet and/or the wood cabinet itself. Always lift the speaker and carry it to its new location.

SPEAKER CONNECTIONS

CONNECTION TIPS

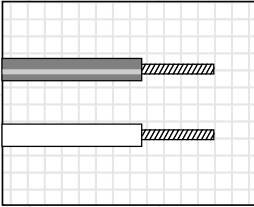

Speakers and electronics terminals have corresponding (+) and (-) terminals. It is important to connect both speakers identically: (+) on the speaker to (+) on the

amplifier and (-) on the speaker to (-) on the amplifier. Wiring "out of phase" results in thin sound, weak bass and a poor stereo image.

SPEAKER-LEVEL CONNECTIONS

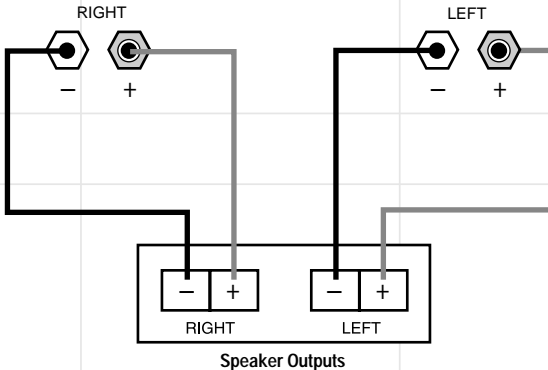

Your S412P speakers should be connected to your receiver in two ways (at speaker level and line level) in order to achieve the best performance, especially when listening to program material recorded in digital 5.1 formats, such as Dolby** Digital and DTS.[®] Connect the left-front and

right-front speaker terminals on your receiver or amplifier to the 5-way binding posts on the back of each S412P speaker. Remember to maintain the correct polarities ("+" to "+" and "-" to "-"). The S412P uses a red binding post for "+" and black for "-". These connections will provide full-range

sound to all four transducers, and you should ALWAYS make these connections. If your receiver or amplifier does not have a line-level subwoofer output, then you do not need to make any other connections, and you should skip to the section titled "Amplifier Controls."

LINE-LEVEL CONNECTIONS

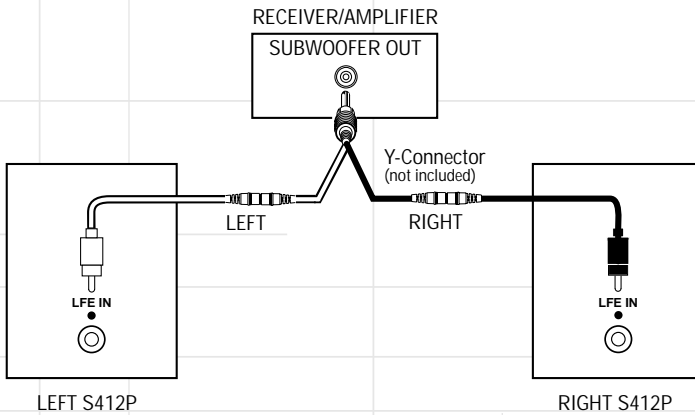

Each S412P speaker is also equipped with a line-level Low-Frequency Effects (LFE/Subwoofer) input for superior performance with digital 5.1 surround formats. The .1 LFE channel contains additional low-frequency information not found in the left- and right-front channels. The LFE input works with the full-range speaker-level input to provide the dynamics and

effects that your favorite filmmakers intended. You will need to use a Y-Connector (not included) with one male connector and two female connectors to connect the line-level subwoofer output on your receiver/amplifier to the LFE/Subwoofer inputs on the S412P speakers. Plug the male connector into the subwoofer output on your receiver or amplifier, and connect each of the

two female connectors to extension RCA patch cords. Then plug each patch cord into the LFE/Subwoofer input of the left and right S412P speakers. **Note:** If your receiver has separate left and right line-level subwoofer (or LFE) output jacks, you do not need to use a Y-Connector.

AMPLIFIER CONTROLS

LFE Level Control: Allows you to adjust the volume of the low-frequency effects/subwoofer channel to suit your room acoustics or tastes. However, it only affects the LFE signal. If you are not using the LFE input, the LFE level control will not operate.

Configuring Your Receiver: You should choose the "Large" or "Wide" option for the left- and right-front speakers so that full low-frequency information will be sent to the S412P speakers. Make sure that you also configure your receiver for "Subwoofer On" or "LFE On." In this case, the LFE/Subwoofer signal will consist only of the .1 (bass) channel. The LFE signal level can be adjusted by using the LFE level on the S412P amplifier panel. For initial setup, you should set the level controls on both speakers at minimum (full counterclockwise rotation). With 5.1 source material playing, advance the level controls on each speaker slowly until the desired amount of effects channel is present. This is a rather subjective adjustment and should be made using a variety of program materials.

If you choose, you can use the "Small" or "Narrow" setting on your receiver. In this case, all of the information below 80Hz will be fed to the LFE/Subwoofer input on the

S412P. Now the level control operates throughout the entire bass spectrum below 80Hz, not just within the .1 channel portion. This configuration is generally unnecessary but, in certain room-placement conditions, it allows greater bass-level control.

Power Switches: The main "Power" switch is simply marked "On" and "Off." Turn this switch on to commence operation of the powered amplifier after you have plugged the power cord into an AC outlet. The second switch is labeled "On/Off" and has two positions. Placing the switch in the "Auto" position puts the amplifier in Standby mode. In this mode the speaker will be able to automatically sense an incoming signal, which will trigger it to turn fully on. The speaker will also automatically switch itself back into Standby mode after approximately 10 to 15 minutes have passed without its sensing a signal. We recommend that you leave this switch in the "Auto" position for most applications. If you will be away from home or not using your speakers for an extended period of time, you should turn the speakers off by using the main power switch. The Manual position will bypass the auto-sensing feature and leave the amplifier on until turned off with the main switch or returned to

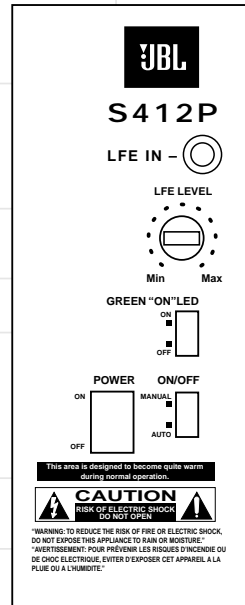

auto sensing by choosing the auto position.

LED Indicators: When your speaker is turned on but is not receiving a signal, the LEDs glow red to let you know that your speaker is plugged in. When the speaker is receiving a signal, the LEDs glow green. We have provided a convenient "Green 'On' LED" switch on the back panel to allow you to shut off the front LEDs should they interfere with your enjoyment of a movie. This switch has no effect when the LEDs are in red mode.

TROUBLESHOOTING

If there is no sound from any of the speakers:

- Check that receiver/ amplifier is on and that a source is playing.
- Review proper operation of your receiver/amplifier.

If there is no sound coming from one speaker:

- Check the "Balance" control on your receiver/amplifier.
- Check all wires and connections between receiver/amplifier and speakers.
- Make sure all wires are connected. Make sure none of the speaker wires are frayed, cut or punctured.

If the system plays at low volumes but shuts off as volume is increased:

- Check all wires and connections between receiver/amplifier and speakers.
- Make sure all wires are connected. Make sure none of the speaker wires are frayed, cut or punctured.
- If more than one pair of main speakers is being used, check the minimum impedance requirements of your receiver/amplifier.

If there is no (or low) bass output:

- Make sure the polarities (+ and -) of the left and right "Speaker Inputs" are connected properly.
- Make sure that the speaker is plugged into an active electrical outlet and switched on, and that the green LEDs are displayed.

If you used the LFE input and there is no sound from the subwoofer:

- Check that receiver/ amplifier is on and that a source is playing.
- Make sure that the speaker is plugged into an active electrical outlet.
- Check all wires and connections between receiver/amplifier and speakers.
- Make sure all wires are connected. Review the "Line-Level Connections" section on page 5 of this manual and make sure that a single RCA patch cord is connected to each loudspeaker from the Y-Connector plugged into the receiver/amplifier's subwoofer output. Make sure none of the speaker wires are frayed, cut or punctured.
- Review proper operation of your receiver/amplifier, including making sure that you have configured your receiver so that the subwoofer output is active.

If you are using the S412P LFE/Subwoofer input and the bass level decreases (instead of increasing) when you turn the LFE/ Subwoofer Level knob clockwise:

- Recheck to make sure that your receiver or amplifier-speaker outputs are correctly connected to the S412P speaker inputs (gold-plated binding posts), (+) to (+) and (-) to (-). The S412P (+) terminal has a red stripe and is located on the right-hand side, below the letter "L" of the molded JBL logo, when looking directly at the back of the S412P.
- If the wires are connected properly, the confusion may be attributable to the design of your receiver/ amplifier. Your unit may have inverting inputs, which reverse the polarity of the signal between the inputs and outputs of the amplifier. To check if this is the case, reverse the speaker connections for **ALL** S412Ps in your system (and disconnect any other speakers in the system) so that the receiver/amplifier's (+) connector is connected to each S412P's (-) (black stripe) speaker connector. If you do this and the S412Ps function properly (bass increases as you turn your LFE/Subwoofer level-control knobs clockwise), your receiver/amp uses inverting inputs. This is not a problem. Simply connect all of the speakers in your system the same way, with the receiver or amplifier's (+) terminal to the speaker's (-) terminal, and the receiver or amplifier's (-) terminal to the speaker's (+) terminal.

SPECIFICATIONS

S412P

Maximum Recommended Amplifier Power*:	250W
Powered Subwoofer Amplifier Output:	200W
Nominal Impedance:	8 Ohms
Sensitivity (2.83V/1m):	91dB
Frequency Response (-3dB):	32Hz – 20kHz
Crossover Frequencies:	200Hz, 850Hz, 3500Hz
High-Frequency Transducer:	1" Pure-titanium dome
Midrange Transducer:	4" PolyPlas™ cone
Midbass Transducer:	6" PolyPlas™ cone
Low-Frequency Transducer:	12" PolyPlas™ cone
Dimensions (H x W x D):	44" x 16" x 13-3/8" (1118mm x 406mm x 340mm)
Weight (per speaker):	86 lb (39.1 kg)

*The maximum recommended amplifier power rating will ensure proper system headroom to allow for occasional peaks. We do not recommend sustained operation at these maximum power levels.

Occasional refinements may be made to existing products without notice but will always meet or exceed original specifications, unless otherwise stated.

**Trademark of Dolby Laboratories.

DTS is a registered trademark of Digital Theater Systems, Inc.

OWNER'S GUIDE

PRODUCT LINE: **STUDIO SERIES**

MODEL NUMBER: **S412P**

DESIGN GOAL: Bring the thrill of live performance and movie sound to the home environment by calling on JBL's professional engineering leadership.

TWEETER TYPE: Pure-titanium dome with EOS™ waveguide

WOOFER TYPE: Cast-aluminum basket with HeatScape™ motor structure

CROSSOVER NETWORK: Straight-Line Signal Path™ (SSP)

PORT DESIGN: FreeFlow™ flared

PROFESSIONAL REFERENCE: Studio Monitor

JBL

**PRO SOUND
COMES HOME™**

JBL Consumer Products
250 Crossways Park Drive, Woodbury, NY 11797
8500 Balboa Boulevard, Northridge, CA 91329
800-336-4JBL (4525) (USA only)
www.jbl.com

© 1999 JBL, Incorporated.

JBL is a registered trademark of JBL, Incorporated.

Part No. S412P OIG 

 A Harman International Company

Free Manuals Download Website

<http://myh66.com>

<http://usermanuals.us>

<http://www.somanuals.com>

<http://www.4manuals.cc>

<http://www.manual-lib.com>

<http://www.404manual.com>

<http://www.luxmanual.com>

<http://aubethermostatmanual.com>

Golf course search by state

<http://golfingnear.com>

Email search by domain

<http://emailbydomain.com>

Auto manuals search

<http://auto.somanuals.com>

TV manuals search

<http://tv.somanuals.com>