

# JRX212

## 12 Inch Two-Way Stage Monitor Loudspeaker System

### Key Features:

- ▶ JBL 12 in low frequency driver with a 64 mm (2.5 in) diameter edgewound voice coil which provides more cross-sectional wire area in the voice coil gap than round wire designs, for greater efficiency and power handling.
- ▶ JBL 2414H-C 25 mm (1 in) polymer diaphragm compression driver improves high frequency performance as well as system reliability.
- ▶ The advanced network topology crossover design shapes frequency response and delivers “coherent summation” in the crossover region.
- ▶ High-voltage capacitors and inductors with massive cores and heavy gauge wire enable the crossover network to handle high power without saturating.
- ▶ Progressive Transition™ high frequency waveguide provides superior coverage control, reduced distortion, and smoother frequency response.
- ▶ The rugged, acoustically superior enclosure is constructed from 19 mm (.75 in) MDF (Medium Density Fiberboard) using advanced adhesives and mechanical fastener technology for extreme durability and improved low-frequency performance.
- ▶ SonicGuard™ protects the high-frequency driver from excess power without interrupting the performance.
- ▶ Non-resonant, all-steel handles are used.
- ▶ Attractive 18-gauge hexagon perforated, steel grille protects components from damage.
- ▶ Dual-angle pole-mount socket allows the speaker to tilt 10° for more uniform audience coverage.



The JRX212 is a portable, twelve-inch, two-way speaker system designed specifically for live performance stage monitoring applications. With enough sensitivity and power handling to cut through the performance volume on stage, the JRX212 has a smooth response so it can deliver maximum gain before feedback. It also includes JBL's dual-angle pole socket making it equally at home as a front-of-house speaker.

### Specifications:

System Type: 12" 2-way, stage monitor	
4 $\pi$ Frequency Range (-10 dB) <sup>1</sup> :	75 Hz – 20 kHz
2 $\pi$ Frequency Range (-10 dB) <sup>1</sup> :	60 Hz – 20 kHz
4 $\pi$ Frequency Response ( $\pm 3$ dB) <sup>1</sup> :	110 Hz – 18 kHz
2 $\pi$ Frequency Response ( $\pm 3$ dB) <sup>1</sup> :	80 Hz – 18 kHz
Sensitivity (1w/1m):	98 dB
Nominal Impedance:	8 $\Omega$
Power Capacity <sup>2</sup> :	250 watts
Peak Power Capacity <sup>2</sup> :	1000 watts
Recommended Amplifier Power:	250-500 watts @ 8 $\Omega$
Maximum SPL:	128 dB
Nominal Dispersion:	90° x 50°
Crossover Frequency:	2.1 kHz
Dimensions (H x W x D) <sup>3</sup> :	584 mm x 399 mm x 325 mm (23 in x 15.7 in x 12.8 in)
Weight:	19.5 kg (43 lb)
Shipping Weight:	22.0 kg (49 lb)
High Frequency Driver:	JBL 2414H-C 1" exit compression driver mounted on Progressive Transition™ Waveguide
Low Frequency Driver:	JBL M112-8
Input Connectors:	Neutrik® Speakon® NL-4 (x1); ¼" TS phone jack (x1); parallel
Enclosure Construction:	19 mm (¾ in) MDF (Medium Density Fiberboard); with glued and mechanically fastened joint detail; covered in black carpet.
Grille:	18-gauge, powder-coated steel
Mounting & Suspension:	36 mm, dual-angle pole-mount socket

<sup>1</sup> "Frequency Range" and "Frequency Response" are based on half-space response.

<sup>2</sup> "Power Capacity" and "Peak Power Capacity" ratings are based on the average and peak power capacity of product samples subjected to a 100 hour power test using random noise with a 6 dB crest factor, in accordance with IEC standards.

<sup>3</sup> Height dimension includes feet.

JBL continually engages in research related to product improvement. Some materials, production methods and design refinements are introduced into existing products without notice as a routine expression of that philosophy. For this reason, any current JBL product may differ in some respect from its published description, but will always equal or exceed the original design specifications unless otherwise stated.

# ► JRX212 12 Inch Two-Way Stage Monitor Loudspeaker System

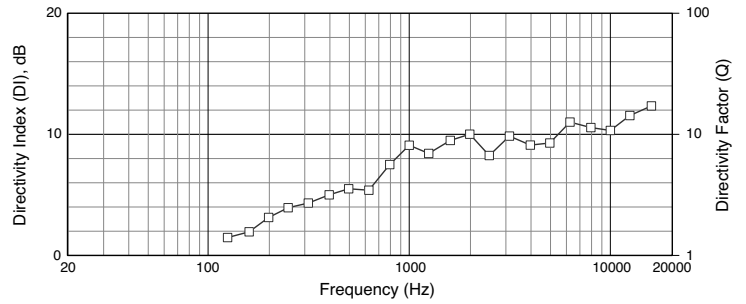
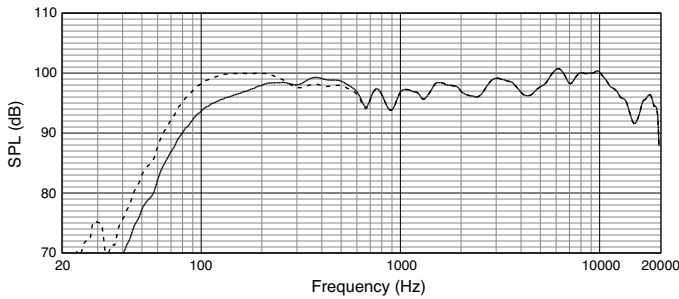
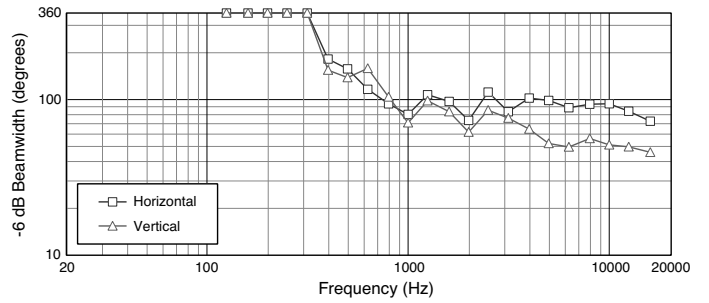
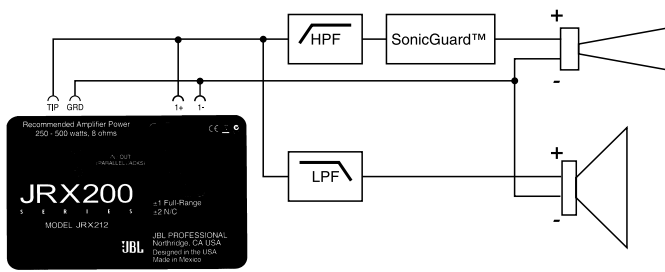

## Dimensions

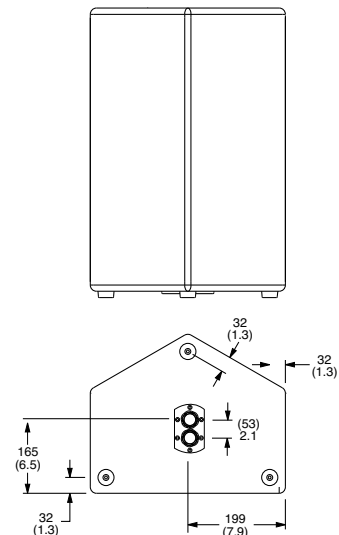
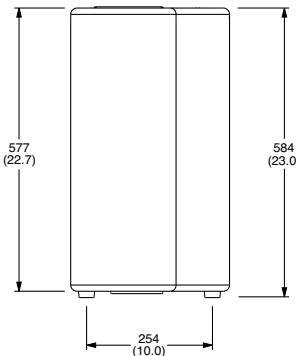
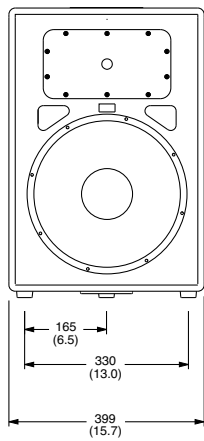
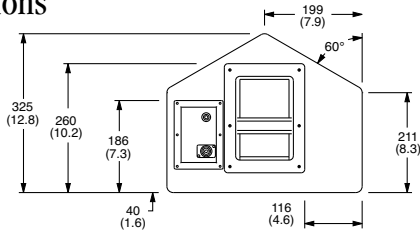

Dimensions in mm (in)



JBL Professional  
8500 Balboa Boulevard, P.O. Box 2200  
Northridge, California 91329 U.S.A.

© Copyright 2013 JBL Professional  
[www.jblpro.com](http://www.jblpro.com)

SSJRX212  
CRP  
06/13

## Free Manuals Download Website

<http://myh66.com>

<http://usermanuals.us>

<http://www.somanuals.com>

<http://www.4manuals.cc>

<http://www.manual-lib.com>

<http://www.404manual.com>

<http://www.luxmanual.com>

<http://aubethermostatmanual.com>

Golf course search by state

<http://golfingnear.com>

Email search by domain

<http://emailbydomain.com>

Auto manuals search

<http://auto.somanuals.com>

TV manuals search

<http://tv.somanuals.com>