

The JBL logo is displayed in white, bold, sans-serif capital letters within an orange square background.

Simply Cinema™



SCS125 simple setup guide

thank you for choosing JBL. For more than 50 years, JBL has been involved in every aspect of music and film recording and reproduction, from live performances to monitoring the recordings you play in your home, car or office.

We're confident that the JBL system you have chosen will provide every note of enjoyment that you expected – and that when you think about purchasing additional audio equipment for your home, car or office, you will once again choose JBL.

Please take a moment to complete the enclosed profile card. It enables us to keep you posted on our latest advancements, and helps us to better understand our customers and build products that meet their needs and expectations.

JBL Consumer Products

read first! Important Safety Precautions!

CAUTION

**RISK OF ELECTRIC SHOCK
DO NOT OPEN**

CAUTION: To prevent electric shock, do not remove the grounding plug on the power cord, or use any plug or extension cord that does not have a grounding plug provided.

Make certain that the AC outlet is properly grounded. Do not use an adapter plug with this product.



The lightning flash with arrowhead symbol, within an equilateral triangle, is intended to alert the user to the presence of uninsulated "dangerous voltage" within the product's enclosure that may be of sufficient magnitude to constitute a risk of electric shock to persons.



The exclamation point within an equilateral triangle is intended to alert the user to the presence of important operating and maintenance (servicing) instructions in the literature accompanying the appliance.

- 1. Read Instructions.** All the safety and operating instructions should be read before the product is operated.
- 2. Retain Instructions.** The safety and operating instructions should be retained for future reference.
- 3. Heed Warnings.** All warnings on the product and in the operating instructions should be adhered to.
- 4. Follow Instructions.** All operating and use instructions should be followed.
- 5. Cleaning.** Unplug this product from the wall outlet before cleaning. Do not use liquid cleaners or aerosol cleaners. Use a damp cloth for cleaning.
- 6. Attachments.** Do not use attachments not recommended by the product manufacturer, as they may cause hazards.
- 7. Water and Moisture.** Do not use this product near water – for example, near a bathtub, wash bowl, kitchen sink or laundry tub; in a wet basement; near a swimming pool; and the like.
- 8. Accessories.** Do not place this product on an unstable cart, stand, tripod, bracket or table. The product may fall, causing serious injury to a child or an adult, and serious damage to the product. Use only with a cart, stand, tripod, bracket or table recommended by the manufacturer, or sold with the product. Any mounting of the product should follow the manufacturer's instructions, and should use a mounting accessory recommended by the manufacturer.
- 9. A Product and Cart Combination Should Be Moved with Care.** Quick stops, excessive force and uneven surfaces may cause the product and cart combination to overturn.
- 10. Ventilation.** Slots and openings in the cabinet are provided for ventilation and to ensure reliable operation of the product and to protect it from overheating, and these openings must not be blocked or covered. The openings should never be blocked by placing the product on a bed, sofa, rug or other similar surface. This product should not



be placed in a built-in installation such as a bookcase or rack unless proper ventilation is provided or the manufacturer's instructions have been adhered to.

11. Power Sources. This product should be operated only from the type of power source indicated on the marking label. If you are not sure of the type of power supply to your home, consult your product dealer or local power company. For products intended to operate from battery power or other sources, refer to the operating instructions.

12. Grounding or Polarization. This product may be equipped with a polarized alternating-current line plug (a plug having one blade wider than the other). This plug will fit into the power outlet only one way. This is a safety feature. If you are unable to insert the plug fully into the outlet, try reversing the plug. If the plug should still fail to fit, contact your electrician to replace your obsolete outlet. Do not defeat the safety purpose of the polarized plug.

13. Power-Cord Protection. Power-supply cords should be routed so that they are not likely to be walked on or pinched by items placed upon or against them, paying particular attention to cords at plugs, convenience receptacles and the point where they exit from the product.

14. Nonuse Periods. The power cord of the product should be unplugged from the outlet when left unused for long periods of time.

15. Outdoor Antenna Grounding. If an outside antenna or a cable system is connected to the product, be sure the antenna or cable system is grounded so as to provide some protection against voltage surges and built-up static charges. Article 810 of the National Electrical Code, ANSI/NFPA 70, provides information with regard to proper grounding of the mast and supporting structure, grounding of the lead-in wire to an antenna discharge unit, size of grounding conductors, location of antenna-discharge unit, connection to grounding electrodes and requirements for the grounding electrode. See Figure 1.

16. Lightning. For added protection for this product during a lightning storm, or when it is left unattended and unused for long periods of time, unplug it from the wall outlet and disconnect the antenna or cable system. This will prevent damage to the product due to lightning and power-line surges.

17. Power Lines. An outside antenna system should not be located in the vicinity of overhead power lines, other electric light or power circuits, or where it can fall into such power lines or circuits. When installing an outside antenna system, extreme care should be taken to keep from touching such power

lines or circuits, as contact with them might be fatal.

18. Overloading. Do not overload wall outlets, extension cords or integral convenience receptacles, as this can result in a risk of fire or electric shock.

19. Object and Liquid Entry. Never push objects of any kind into this product through openings, as they may touch dangerous voltage points or short-out parts that could result in a fire or electric shock. Never spill liquid of any kind on the product.

20. Servicing. Do not attempt to service this product yourself, as opening or removing covers may expose you to dangerous voltage or other hazards. Refer all servicing to qualified service personnel.

21. Damage Requiring Service. Unplug this product from the wall outlet and refer servicing to qualified service personnel under the following conditions:

- a. The power-supply cord or the plug has been damaged; or
- b. Objects have fallen onto, or liquid has been spilled into, the product; or
- c. The product has been exposed to rain or water; or
- d. The product does not operate normally when following the operating instructions. Adjust only those controls that are covered by the operating instructions, as an improper adjustment of other controls may result in damage and will often require extensive work by a qualified technician to restore the product to its normal operation; or
- e. The product has been dropped or damaged in any way; or
- f. The product exhibits a distinct change in performance – this indicates a need for service.

22. Replacement Parts. When replacement parts are required, be sure the service technician has used replacement parts specified by the manufacturer or that have the same characteristics as the original part. Unauthorized substitutions may result in fire, electric shock or other hazards.

23. Safety Check. Upon completion of any service or repairs to this product, ask the service technician to perform safety checks to determine that the product is in proper operating condition.

24. Wall or Ceiling Mounting. The product should be mounted to a wall or ceiling only as recommended by the manufacturer.

25. Heat. The product should be situated away from heat sources such as radiators, heat registers, stoves or other products (including amplifiers) that produce heat.

Figure 1.

Example of Antenna Grounding as per National Electrical Code ANSI/NFPA 70

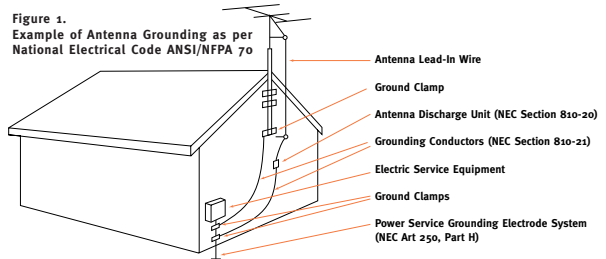

included

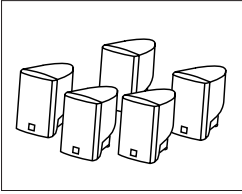

Five satellites for left, right, center and surrounds. With wall-mount brackets.

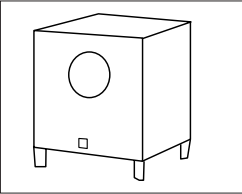

Powered subwoofer.

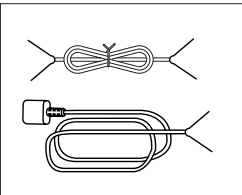

Three 20' speaker cables for connection from receiver to subwoofer.

Three 15' speaker cables for connection from subwoofer to front satellites.

Two 40' speaker cables for connection from receiver to rear satellites.

one. Speaker Placement

Satellites

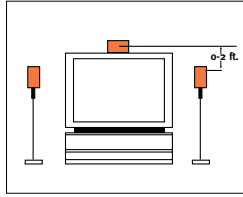
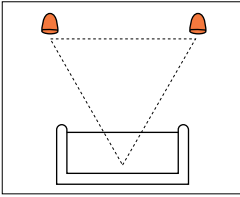

Subwoofer

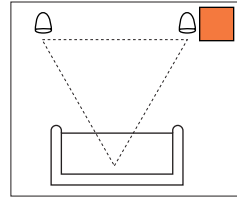

Surround Speakers

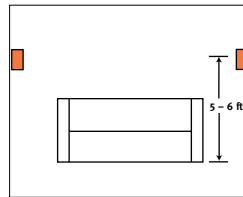
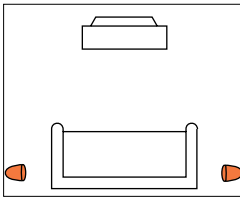

Mounting Options

Satellites and Surrounds

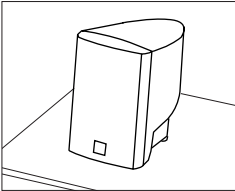

On shelves.

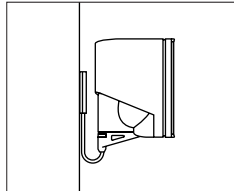

On the wall. Wall brackets included.

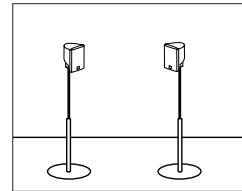

On optional stands. FS300.

Wall Mounting

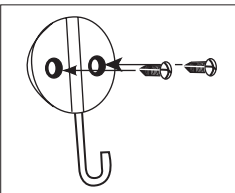

Attach plate to wall.

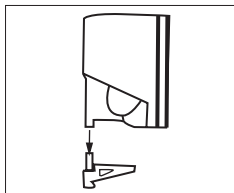

Slide speaker onto support.

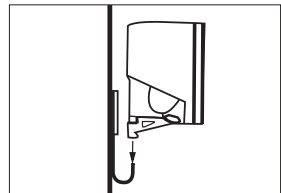

Place speaker and support on wall plate.

The customer is responsible for proper selection and use of mounting hardware, available through hardware stores, to properly and safely wall-mount the speakers.

Line Level

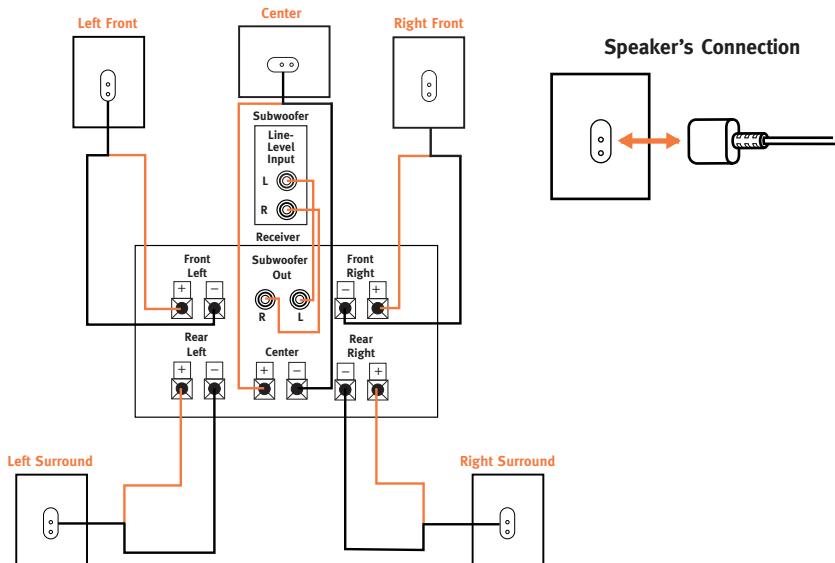

three. Operation

Mode	Procedure	LED Status
Off	Receiver/amplifier off	Off
On	Receiver/amplifier on and playing program material	Green
Standby	Simply turn off your receiver/amplifier. The subwoofer will turn off after approximately twenty minutes. The subwoofer will turn on when your receiver/amplifier begins playing again.	Red

Volume

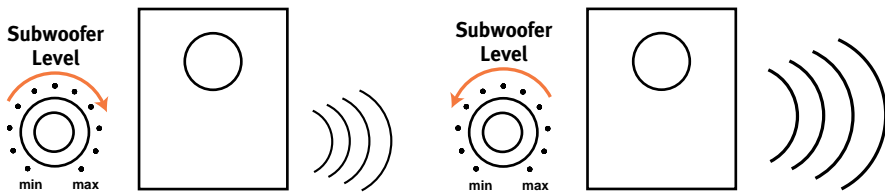

Troubleshooting

If there is no sound from any of the speakers, check the following:

- Receiver/amplifier is on and a source is playing.
- Powered subwoofer is plugged in and is either in the "On" or "Auto" position.
- Check all wires and connections between receiver/amplifier and speakers. Make sure all wires are connected. Make sure none of the speaker wires are frayed, cut or punctured.
- Review proper operation of your receiver/amplifier.

If there is no sound coming from one speaker, check the following:

- Check the "Balance" control on your receiver/amplifier.
- Check all wires and connections between receiver/amplifier and speakers. Make sure all wires are connected.

Make sure none of the speaker wires are frayed, cut or punctured.

If the system plays at low volumes but shuts off as volume is increased, check the following:

- Check all wires and connections between receiver/amplifier and speakers. Make sure all wires are connected. Make sure none of the speaker wires are frayed, cut or punctured.
- If more than one pair of main speakers is being used, check the minimum impedance requirements of your receiver/amplifier.

If there is low bass output, check the following:

- Make sure the connections to the left and right "Speaker Inputs" have the correct polarity (+ and -).

- Make sure that the subwoofer is plugged into an active electrical outlet.
- Powered subwoofer is plugged in and is either in the "On" or "Auto" position.

If there is no sound from the surround speakers, check the following:

- Check all wires and connections between receiver/amplifier and speakers. Make sure all wires are connected. Make sure none of the speaker wires are frayed, cut or punctured.
- Review proper operation of your receiver/amplifier and its surround sound features.
- Make sure the movie or TV show you are watching is recorded in Dolby surround. If it is not, check to see if your receiver/amplifier has other surround modes you may use.

Specifications

SCS125 System

Frequency Response
35Hz – 20kHz (-6dB)

sat125

Recommended Power

10 – 50 watts

Impedance

8 ohms nominal

Sensitivity

86dB @ 1 watt/1 meter

Tweeter

One 1/2"-dome, video shielded

Midrange

3" driver, video shielded

Dimensions (H x W x D)

4-3/8 x 3-3/16 x 3-3/4 inches
111 x 81 x 95mm

Weight

1 lb./45 kg

sub125

Amplifier

75 watts RMS

Bass

8" woofer, bass-reflex enclosure

Dimensions (H x W x D)

14-1/8 x 13 x 13 inches
359 x 330 x 330mm

Weight

27.5 lbs/12.5 kg

Refinements may be made on occasion to existing products without notice, but will always meet or exceed original specifications unless otherwise stated.



JBL Consumer Products
250 Crossways Park Drive, Woodbury, NY 11797
8500 Balboa Boulevard, Northridge, CA 91329
1-800-336-4JBL (4525) (USA only)

© 1998 JBL, Incorporated. JBL and Simply Cinema
are registered trademarks of JBL, Incorporated.

Printed 7/98 ♻️ Part No. SCS1250M

H A Harman International Company

Free Manuals Download Website

<http://myh66.com>

<http://usermanuals.us>

<http://www.somanuals.com>

<http://www.4manuals.cc>

<http://www.manual-lib.com>

<http://www.404manual.com>

<http://www.luxmanual.com>

<http://aubethermostatmanual.com>

Golf course search by state

<http://golfingnear.com>

Email search by domain

<http://emailbydomain.com>

Auto manuals search

<http://auto.somanuals.com>

TV manuals search

<http://tv.somanuals.com>