

SYNTHESIS[®]

JBL

SYNTHESIS[®]
SDEC-3000
SDEC-4000
DIGITAL
EQUALIZER
INSTALLER'S
MANUAL

CONTENTS

PRECAUTIONS	3
INTRODUCTION AND FEATURES	4
DETAILED DIAGRAMS	5
FRONT PANEL	5
REAR PANEL	6
INPUT/OUTPUT ASSIGNMENTS	7
SDEC-3000	7
SDEC-4000	8
SDEC-4000 WITH BI-AMPLIFIED FRONT SPEAKERS	9
SDEC-4000 WITH FULL-RANGE FRONT SPEAKERS	10
CONNECTION TO THE REST OF THE JBL SYNTHESIS SYSTEM	12
SDEC-3000	12
SDEC-4000 WITH BI-AMPLIFIED SPEAKERS	13
SDEC-4000 WITH FULL-RANGE FRONT SPEAKERS	14
TECHNICAL SPECIFICATIONS	15

IMPORTANT SAFETY PRECAUTIONS!

PLEASE READ CAREFULLY ALL OF THE FOLLOWING IMPORTANT SAFEGUARDS THAT ARE APPLICABLE TO YOUR EQUIPMENT

1. Read these instructions.
2. Keep these instructions.
3. Heed all warnings.
4. Follow all instructions.
5. Do not use this apparatus near water.
6. Clean only with a dry cloth.
7. Do not block any ventilation openings. Install in accordance with the manufacturer's instructions.
8. Do not install near any heat sources such as radiators, heat registers, stoves or other apparatus (including amplifiers) that produce heat.
9. Do not defeat the safety purpose of the polarized or grounding-type plug. A polarized plug has two blades with one wider than the other. A grounding-type plug has two blades and a third grounding prong. The wide blade or the third prong is provided for your safety. If the provided plug does not fit into your outlet, consult an electrician for replacement of the obsolete outlet.
10. Protect the power cord from being walked on or pinched, particularly at plugs, convenience receptacles and the point where they exit from the apparatus.
11. Only use attachments/accessories specified by the manufacturer.
12. Use only with the cart, stand, tripod, bracket or table specified by the manufacturer or sold with the apparatus. When a cart is used, use caution when moving the cart/apparatus combination to avoid injury from tip-over.
13. Unplug this apparatus during lightning storms or when unused for long periods of time.
14. Refer all servicing to qualified service personnel. Servicing is required when the apparatus has been damaged in any way, such as power-supply cord or plug is damaged, liquid has been spilled or objects have fallen into the apparatus, the apparatus has been exposed to rain or moisture, does not operate normally, or has been dropped.
15. Do not use attachments not recommended by the product manufacturer, as they may cause hazards.
16. This product should be operated only from the type of power source indicated on the marking label. If you are not sure of the type of power supply to your home, consult your product dealer or local power company. For products intended to operate from battery power, or other sources, refer to the operating instructions.
17. If an outside antenna or cable system is connected to the product, be sure the antenna or cable system is grounded so as to provide some protection against voltage surges and built-up static charges. Article 810 of the National Electrical Code, ANSI/NFPA 70, provides information with regard to proper grounding of the mast and supporting structure, grounding of the lead-in wire to an antenna discharge unit, size of grounding conductors, location of antenna-discharge unit, connection to grounding electrodes, and requirements for the grounding electrode. See Figure A.
18. An outside antenna system should not be located in the vicinity of overhead power lines or other electric light or power circuits, or where it can fall into such power lines or circuits. When installing an outside antenna system, extreme care should be taken to keep from touching such power lines or circuits, as contact with them might be fatal.
19. Do not overload wall outlets, extension cords, or integral convenience receptacles, as this can result in a risk of fire or electric shock.
20. Never push objects of any kind into this product through openings, as they may touch dangerous voltage points or short-out parts that could result in a fire or electric shock. Never spill liquid of any kind on the product.
21. The apparatus shall not be exposed to dripping or splashing, and no objects filled with liquids, such as vases, shall be placed on the apparatus.
22. Do not attempt to service this product yourself, as opening or removing covers may expose you to dangerous voltage or other hazards. Refer all servicing to qualified service personnel.
23. When replacement parts are required, be sure the service technician has used replacement parts specified by the manufacturer or that have the same characteristics as the original part. Unauthorized substitutions may result in fire, electric shock or other hazards.
24. Upon completion of any service or repairs to this product, ask the service technician to perform safety checks to determine that the product is in proper operating condition.
25. The product should be mounted to a wall or ceiling only as recommended by the manufacturer.

CAUTION

**RISK OF ELECTRIC SHOCK
DO NOT OPEN**

CAUTION: To reduce the risk of electric shock, do not remove cover (or back). No user-serviceable parts inside. Refer servicing to qualified service personnel.

CAUTION: To prevent electric shock, do not use this (polarized) plug with an extension cord, receptacle or other outlet unless the blades can be fully inserted to prevent blade exposure.

 The lightning flash with arrowhead symbol, within an equilateral triangle, is intended to alert the user to the presence of uninsulated "dangerous voltage" within the product's enclosure that may be of sufficient magnitude to constitute a risk of electric shock to persons.

 The exclamation point within an equilateral triangle is intended to alert the user to the presence of important operating and maintenance (servicing) instructions in the literature accompanying the appliance.



Figure A.
Example of Antenna Grounding as per
National Electrical Code ANSI/NFPA 70

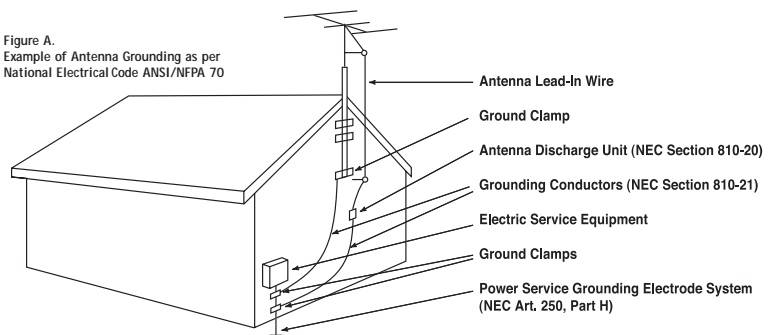

Note to CATV system installer:

This reminder is provided to call the CATV system installer's attention to Article 820-22 of the NEC that provides guidelines for proper grounding and, in particular, specifies that the cable ground shall be connected to the grounding system of the building, as close to the point of cable entry as practical.

INTRODUCTION AND FEATURES

INTRODUCTION

Congratulations on your purchase of this JBL Synthesis® SDEC Digital Equalizer! You have chosen a product that embodies the best of what JBL® has discovered about the emotional power of audio reproduction in more than sixty years of preeminence in the field. This Digital Equalizer has been designed and crafted to provide the user with a high level of sonic performance; special attention has been paid to minimize the number of components in the audio signal path, resulting in extremely low distortion, excellent transient response and wide dynamic range. Synthesis products set new benchmarks in audio technology, and, when used as part of a complete JBL Synthesis system, will bring the ambience and acoustics of some of the world's greatest concert halls and theaters into your home. To obtain the best performance from this Digital Equalizer, please be sure to completely read this user's manual and use the SDEC Digital Equalizer only in accordance with its instructions.

From its inception, JBL Synthesis has been the answer to the questions: "How do you build a state-of-the-art home theater system and make it sound superb in every installation? How can you be sure all the hardware is compatible?" These were the big questions fifteen years ago; Synthesis was the answer. Once again, JBL Synthesis moves beyond the competition and is the answer. The JBL Synthesis Digital Equalizer (SDEC) is a (up to) 12-channel-in/20-channel-out 24-bit, 96kHz digital audio signal processor. Unlike nearly all other audio components on the market, the SDEC has been designed to work specifically with other Synthesis System components. This narrow application focus has allowed our engineers to design a product with far fewer compromises, resulting in unequalled system performance. By reading the following pages, you will become familiar with the technological features and unique capabilities incorporated within the SDEC and available nowhere else.

Until now, anything beyond the most basic equalization has been impossible without expensive acoustical instrumentation and the knowledge to use it. This is why, traditionally, equalizers have been general-purpose devices, designed to be applicable to any audio system, usually of doing more harm than good! Add to this situation the fact that equalizing a speaker system by ear is truly a futile exercise. This helps to account for the generally low acceptance of equalizers outside of professional audio applications.

FEATURES

- Up to 120 bands of fully parametric EQ
- Built-in crossover for bi-amp outputs (SDEC-4000 only)
- Delay adjustment for each output
- Delay adjustment for driver compensation
- Four subwoofer outputs (SDEC-4000 only)
- Two pairs of side speaker outputs for large rooms with multiple rows of seating (SDEC-4000 only)
- 24-Bit DSP
- 96kHz sample rate on all inputs and outputs
- Balanced or Single-Ended (unbalanced) inputs and outputs

DETAILED DIAGRAM – FRONT PANEL

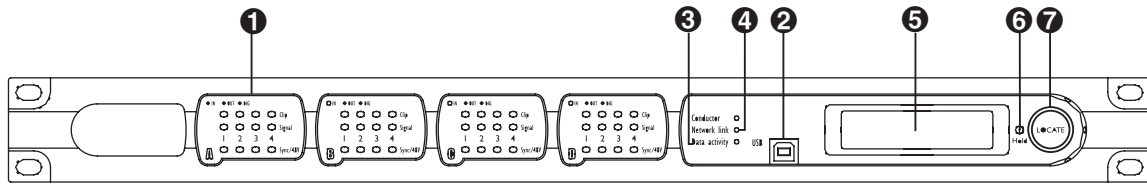

1 INPUT/OUTPUT CARD MONITORING

Each channel has three LED indicators showing:

CLIP

Illuminated – Indicates clipping in the analog domain for each channel of the fitted Input or Output card. The LED will light at +18.5dB.

SIGNAL

Illuminated – The Signal LED will light for each channel of a fitted Input or Output card when the signal reaches or exceeds the signal threshold of -20dB.

PHANTOM

This feature is currently not supported by JBL Synthesis (lights to indicate +48V phantom power has been activated for the relevant channel of a fitted input card).

2 USB

This is currently for future use and is not supported.

3 DATA ACTIVITY

The Data Activity LED will flash to indicate that the device is communicating with another control device, either on the network or via the USB, serial or control ports.

4 NETWORK LINK

The Network Link indicates the presence of Cat. 5 Ethernet cables. If no cables are connected, the LED is unlit; the LED flashes if either a control or CobraNet® cable is fitted, and remains illuminated if both cables are connected. The network link is used for configuring and calibrating the Synthesis System when using the DACS calibration, and for system status when using the SDEC-4000.

5 LCD (LIQUID CRYSTAL DISPLAY)

Indicates the name/ID and IP address of the unit.

6 CONTRAST (HOLD)

Pressing and holding the Locate switch will cycle the LCD through its contrast range.

7 LOCATE

Pressing the Locate switch on the front of the unit will illuminate the Locate switch on the rear and identify the device within the DACS software.

DETAILED DIAGRAM – REAR PANEL

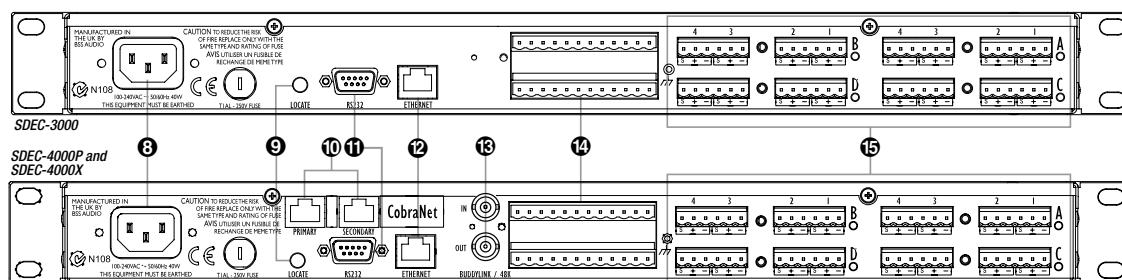

SDEC-3000 has no CobraNet or Word Clock connections, but is otherwise identical to the SDEC-4000P and SDEC-4000X.

8 AC MAINS

AC Mains input to the universal switched-mode power supply, operates over a wide range of AC input voltages from 85V to 270V, 50/60Hz.

9 LOCATE

Pressing the Locate switch on the rear of the unit will illuminate the Locate switch on the front and identify the device within the DACS software.

10 COBRANET CONNECTORS

Primary/Secondary: The SDEC-4000P and SDEC-4000X use CobraNet to send and receive audio data. During normal operation, the Primary port only receives audio data from and transmits audio data to the network. Should the Primary port or connection fail, the CobraNet module automatically switches to receive from and transmit with the Secondary port. This is an optional connection.

Please Note: When using the SDEC-4000, you must connect the two units through the CobraNet connection, using a Cat. 5e crossover cable.

11 RS-232

Serial port for connection of external calibration and configuration equipment not used at this time.

12 ETHERNET

The main connection for the proprietary system control network, and for third-party Ethernet control. The SDEC-4000 must be connected to an Ethernet hub during the calibration process. The SDEC-4000 can be connected directly to a PC using a crossover Cat. 5 Ethernet cable.

13 BUDDYLINK/48k

This connection is not supported at this time.

14 CONTROL INPUTS

The SDEC-4000 can be configured for full-range or bi-amp operation by using these control inputs. The SDEC-3000 does not need or use this connection.

15 I/O CARD POSITIONS A, B, C AND D

These connectors provide the balanced and unbalanced connections for the I/O card fitted in the four card slots in a JBL Synthesis SDEC device. A green LED next to the slot assignment letter A, B, C or D indicates that an Input card is fitted and an amber LED when an output card is fitted. The analog connections are balanced/unbalanced, on Phoenix/Combicon connectors. Depending on which model and configuration you have purchased will determine which I/O card has been installed at the factory. Please make sure to order the correct wiring kit, either S3000IC or S4000IC, with your system.

INPUT/OUTPUT ASSIGNMENTS

SDEC-3000

The SDEC-3000 supports up to 7.1 input with up to 7.1 output. The input and output assignments are as described in the below chart. You must make the correct connections from the surround processor output to the amplifier input for the system to work correctly. Please refer to the connection diagram for more information.

The correct Synthesis Interconnect kit includes all the necessary connections for using the SDEC in the Synthesis system. Please be sure to order the S3000IC for use with SDEC-3000 and S4000IC for use with SDEC-4000. Retrofit kits are also available. Please contact JBL Synthesis Technical Support for more information at (888) 691-4171 (USA only).

CONNECTION NOTES

- Please follow the wiring diagram and the Input/Output Assignments chart for correct connections.
- You will need to use the Ethernet network port on the rear panel of the unit for the final calibration process. You can use a crossover network cable if you plan to connect directly to the SDEC-3000 from a computer. Alternatively, you can connect the SDEC-3000 through any standard Ethernet hub.
- When using the SDP-40 processor, make sure the subwoofer (in speaker setup) is set to Mono output and connect to the Subwoofer Left output.

Input/Output Assignments

<i>Surround Processor to SDEC-3000 Inputs</i>		
<i>S3000IC Number</i>	<i>Channel</i>	<i>SDEC-3000</i>
1	LEFT FRONT	A1
2	RIGHT FRONT	A2
3	CENTER FRONT	A3
4	LEFT SIDE	A4
5	RIGHT SIDE	B1
6	LEFT REAR	B2
7	RIGHT REAR	B3
8	SUBWOOFER (Mono Sub Left)	B4

<i>SDEC-3000 Outputs to Amplifiers</i>		
<i>S3000IC Number</i>	<i>Channel</i>	<i>SDEC-3000</i>
9	LEFT FRONT	C1
10	RIGHT FRONT	C2
11	CENTER FRONT	C3
12	LEFT SIDE	C4
13	RIGHT SIDE	D1
14	LEFT REAR	D2
15	RIGHT REAR	D3
16	SUBWOOFER	D4

INPUT/OUTPUT ASSIGNMENTS

SDEC-4000

The SDEC-4000 comprises two units. Both the SDEC-4000P and SDEC-4000X are *required* for the digital equalizer to function properly in the Synthesis system. Please be sure to connect both units correctly according to the Input/Output Assignments chart.

The correct Synthesis Interconnect kit includes all the necessary connections for using the SDEC in the Synthesis System. Please be sure to order the S3000IC for use with SDEC-3000 and S4000IC for use with SDEC-4000. Retrofit kits are also available. Please contact JBL Synthesis Technical Support for more information at (888) 691-4171 (USA only).

The SDEC-4000 is capable of processing up to 12 inputs and up to 20 outputs. Depending on the type and number of outputs will determine which connections you should use to connect the SDEC to the rest of your system. Please refer to the connection diagram for more information.

CONNECTION NOTES

- The SDEC-4000 can process two outputs for the front left, center and right channels to output to an amplifier for a Bi-amplified system. There are discrete outputs for a single high-frequency horn speaker (SAM1HF) and low-frequency (SAM2LF) speakers. These outputs can only be used with speakers designed to be used with an external crossover. Do not use the SDEC Digital Equalizer for any speakers other than the recommended Synthesis speaker packages.
- There are two pairs of outputs for side speakers. If you are only using one pair of side speakers you may leave the second pair of outputs with no connection. If you are using a second pair of side speakers, you should connect the pair closest to the front speakers to output 1 and the pair closest to the rear speakers to output 2.
- There are up to four subwoofer outputs. You should use them in pairs so that you either have two or four subwoofers. All Synthesis systems are designed for at least two subwoofers.
- You *must* connect the SDEC-4000P and the SDEC-4000X using the CobraNet connection, using an Ethernet network *crossover* cable, Cat. 5e minimum.
- The two units must be connected to an Ethernet network hub for the final calibration process. Both units need to be connected to the same hub or router, and an open port needs to be accessible for the calibration computer.
- When using the SDP-40 processor, make sure the subwoofer (in speaker setup) is set to Mono output and connect to the Subwoofer Left output.

INPUT/OUTPUT ASSIGNMENTS

SDEC-4000 WITH BI-AMPLIFIED FRONT SPEAKERS

This configuration requires the selection of bi-amplified operation, as noted on page 11.

Input/Output Assignments

<i>Surround Processor to SDEC-4000P Inputs</i>		
<i>S4000IC Number</i>	<i>Channel</i>	<i>SDEC-4000P</i>
1	FRONT LEFT	A1
2	FRONT RIGHT	A2
3	CENTER FRONT	A3
4	LEFT SIDE	A4
5	RIGHT SIDE	B1
6	LEFT REAR	B2
7	RIGHT REAR	B3
8	SUBWOOFER (Mono Sub L)	B4
	N/C	C1
	N/C	C2
	N/C	C3
	N/C	C4

<i>SDEC-4000X Outputs to Amplifiers</i>				
<i>S4000IC Number</i>	<i>Channel</i>	<i>SDEC-4000X</i>	<i>Amplifier</i>	<i>Input Channel</i>
9	LEFT FRONT-LOW	A1	S5160 #1	CH1
10	LEFT FRONT-HI	A2	S5160 #1	CH2
11	RIGHT FRONT-LOW	A3	S5160 #1	CH3
12	RIGHT FRONT-HI	A4	S5160 #1	CH4
13	CENTER FRONT-LOW	B1	S5160 #2	CH1
14	CENTER FRONT-HI	B2	S5160 #2	CH2
15	LEFT SIDE 1	B3	S5160 #2	CH3
16	LEFT SIDE 2	B4	optional	–
	N/C	C1	–	–
	N/C	C2	–	–
17	RIGHT SIDE 1	C3	S5160 #2	CH4
18	RIGHT SIDE 2	C4	optional	–
	N/C	D1	–	–
	N/C	D2	–	–
19	LEFT REAR	D3	S5160 #1	CH5
20	RIGHT REAR	D4	S5160 #2	CH5

<i>SDEC-4000P Outputs to Amplifiers</i>				
<i>Number</i>	<i>Channel</i>	<i>SDEC-4000P</i>		
21	SUBWOOFER 1	D1	S800 #1	CH1 (bridged)
22	SUBWOOFER 2	D2	S800 #2	CH1 (bridged)
23	SUBWOOFER 3	D3	S800 #3 (optional)	CH1 (bridged)
24	SUBWOOFER 4	D4	S800 #4 (optional)	CH1 (bridged)

INPUT/OUTPUT ASSIGNMENTS

SDEC-4000 WITH FULL-RANGE FRONT SPEAKERS

This is the default configuration.

Input/Output Assignments

<i>Surround Processor to SDEC-4000P Inputs</i>		
<i>S4000IC Number</i>	<i>Channel</i>	<i>SDEC-4000P</i>
1	FRONT LEFT	A1
2	FRONT RIGHT	A2
3	CENTER FRONT	A3
4	LEFT SIDE	A4
5	RIGHT SIDE	B1
6	LEFT REAR	B2
7	RIGHT REAR	B3
8	SUBWOOFER (Mono Sub L)	B4
	N/C	C1
	N/C	C2
	N/C	C3
	N/C	C4

<i>SDEC-4000X Outputs to Amplifiers</i>				
<i>S4000IC Number</i>	<i>Channel</i>	<i>SDEC-4000X</i>	<i>Amplifier</i>	<i>Input Channel</i>
9	LEFT FRONT	A1	S800 #1	CH1 (bridged)
10	N/C	A2	–	–
11	RIGHT FRONT	A3	S800 #2	CH1 (bridged)
12	N/C	A4	–	–
13	CENTER FRONT	B1	S800 #3	CH1 (bridged)
14	N/C	B2	–	–
15	LEFT SIDE 1	B3	S7150 #1	CH1
16	LEFT SIDE 2	B4	S7150 #1	CH2
	N/C	C1	–	–
	N/C	C2	–	–
17	RIGHT SIDE 1	C3	S7150 #1	CH3
18	RIGHT SIDE 2	C4	S7150 #1	CH4
	N/C	D1	–	–
	N/C	D2	–	–
19	LEFT REAR	D3	S7150 #1	CH5
20	RIGHT REAR	D4	S7150 #1	CH6

<i>SDEC-4000P Outputs to Amplifiers</i>				
<i>S4000IC Number</i>	<i>Channel</i>	<i>SDEC-4000P</i>		
21	SUBWOOFER 1	D1	S800 #4	CH1 (bridged)
22	SUBWOOFER 2	D2	S800 #5	CH1 (bridged)
23	SUBWOOFER 3	D3	S800 #6	CH1 (bridged)
24	SUBWOOFER 4	D4	S800 #7	CH1 (bridged)

INPUT/OUTPUT ASSIGNMENTS

SELECTING BI-AMPED CONFIGURATION

There Are Two Ways to Select Bi-Amped LCR Operation.

Please Note: Only Method One can be done on the control ports (without a computer). Method Two requires a computer running the appropriate configuration software. Please contact JBL Synthesis Technical Support for more information.

METHOD ONE:

With the unit powered up and running, connect Control Input 2 to "C" for bi-amped.

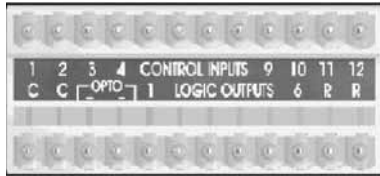

METHOD TWO:

While online and in operate mode from within London Architect™, select the "Main" page and then click on the bi-amped button.



SELECTING FULL-RANGE CONFIGURATION

There Are Two Ways to Select Full-Range LCR Operation.

Please Note: Only Method One can be done on the control ports (without a computer). Method Two requires a computer running the appropriate configuration software. Please contact JBL Synthesis Technical Support for more information.

METHOD ONE:

With the unit powered up and running, connect Control Input 1 to "C" (common) on the back of the unit for full-range.

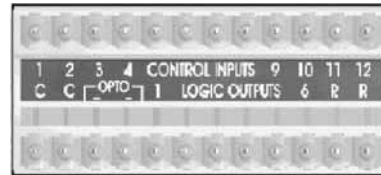

METHOD TWO:

While online and in operate mode from within London Architect, select the "Main" page and then click on the full-range button.



NOTE: The full-range configuration is the default and will not require selection during normal use.

CONNECTION TO THE REST OF THE JBL SYNTHESIS SYSTEM

SDEC-3000

SDP-5

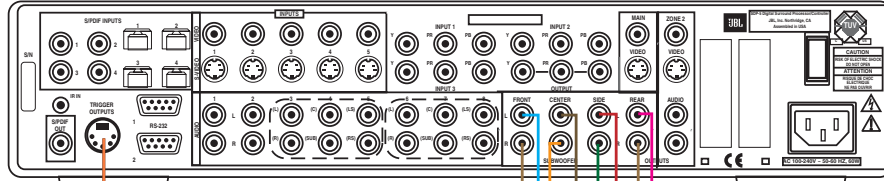

NOTE: Although the SDP-5 is shown here, connections for the SDP-40 are similar.

SDEC-3000

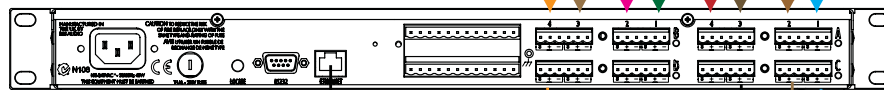

To Ethernet hub
(for system calibration)

S7150

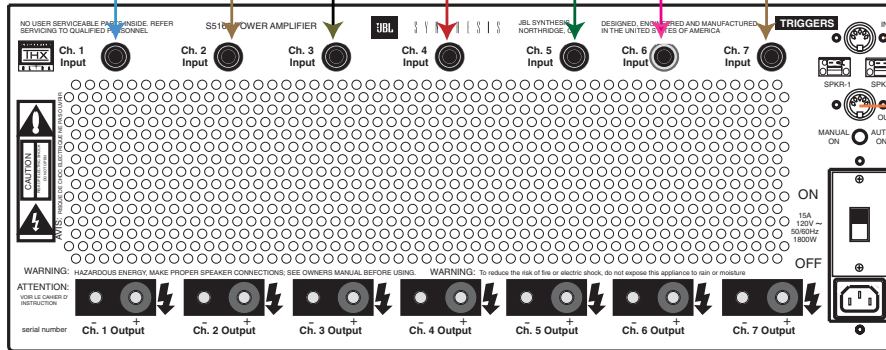

S800

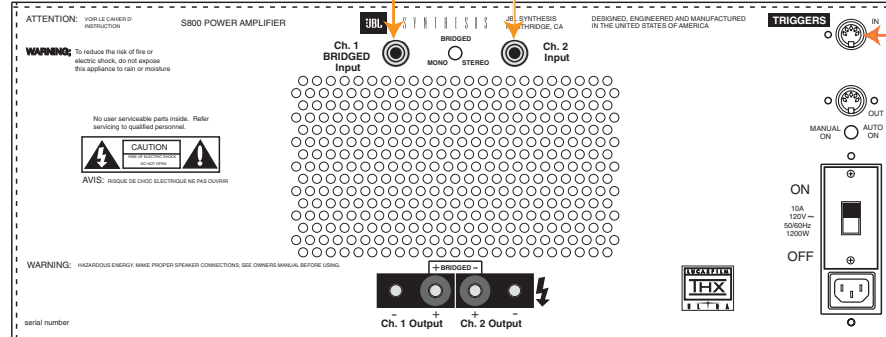

CONNECTION TO THE REST OF THE JBL SYNTHESIS SYSTEM

SDEC-4000 With Bi-Amplified Speakers

SDP-5

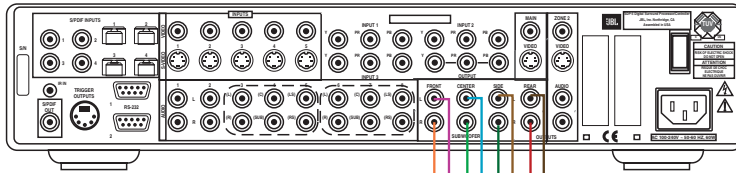

NOTE: Although the SDP-5 is shown here, connections for the SDP-40 are similar.

To Ethernet hub
(for system calibration)

SDEC-4000P

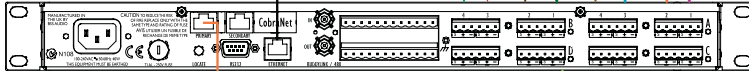

SDEC-4000X

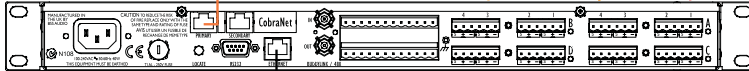

To Ethernet hub
(for system calibration)

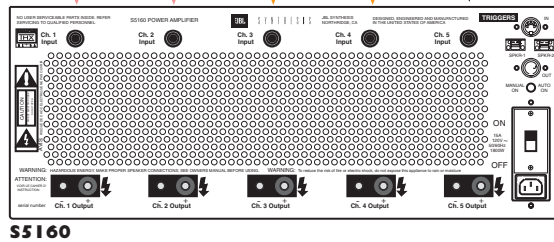

S5160

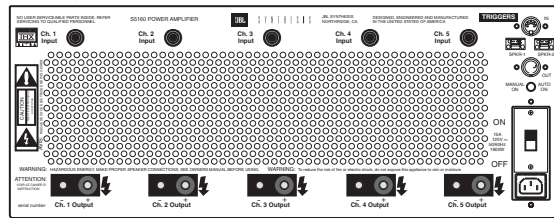

S5160

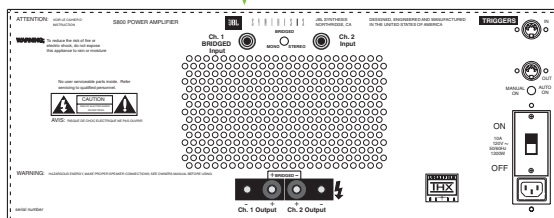

S800

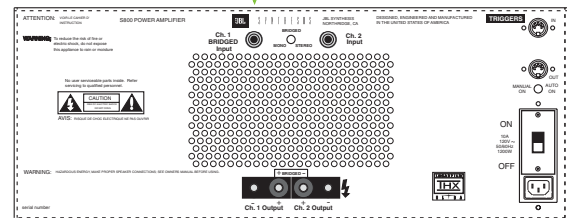

S800

CONNECTION TO THE REST OF THE JBL SYNTHESIS SYSTEM

SDEC-4000 With Full-Range Front Speakers

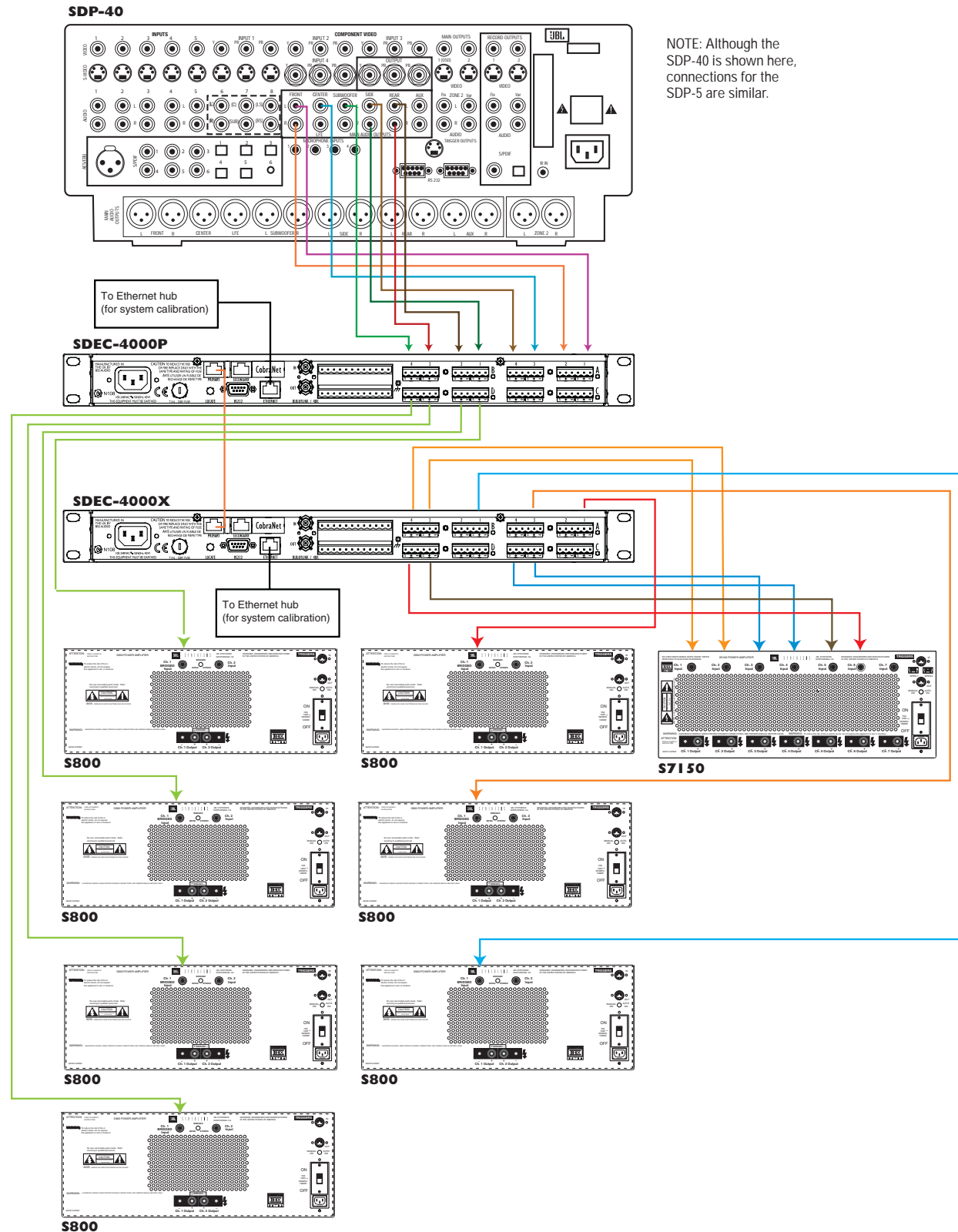

SPECIFICATIONS

INPUTS UP TO 12 ANALOG; ELECTRONICALLY BALANCED ON PHOENIX/COMBICON REMOVABLE SCREW CONNECTORS		
Mic/LINE INPUTS:	NOMINAL GAIN 0dB, ELECTRONICALLY SWITCHABLE UP TO +48dB, IN +6dB STEPS, INPUT IMPEDANCE 3.5K OHMS	
MAXIMUM INPUT LEVEL:	+20dBu WITH 0dB INPUT GAIN (+8dBu WITH 12dB GAIN)	
CMRR:	>75dB AT 1kHz	
EQUIV. INPUT NOISE (EIN):	<-128dBu TYPICAL WITH 150 OHMS SOURCE	
OUTPUTS UP TO 20 ANALOG; ELECTRONICALLY BALANCED ON PHOENIX/COMBICON REMOVABLE SCREW CONNECTORS		
MAXIMUM OUTPUT LEVEL:	+19dBu	
FREQUENCY RESPONSE:	20Hz TO 20kHz (+0.5/-1dB)	
THD:	<0.01% (20Hz TO 20kHz, +10dBu OUTPUT)	
DYNAMIC RANGE:	108dB TYPICAL (22Hz TO 22kHz UNWEIGHTED)	
CROSSTALK:	<-75dB	
CONTROL NETWORK		
COBRANET:	RJ45 CONNECTOR (SDEC-4000P, SDEC-4000X)	
MAXIMUM CABLE LENGTH:	100M/300 FT. BETWEEN DEVICE AND ETHERNET SWITCH	
ETHERNET:	2 x RJ45 CONNECTORS	
MAXIMUM CABLE LENGTH:	100M/300 FT. BETWEEN DEVICE AND ETHERNET SWITCH	
PANEL LED INDICATORS:	SIGNAL PRESENT (PER INPUT), CLIP (PER INPUT), SYNC/48V (PER INPUT), LCD, CONDUCTOR ACTIVE, NET LINK ACTIVE, DATA ACTIVITY	
MAINS VOLTAGE:	85-270V AC, 50/60Hz	
POWER CONSUMPTION:	<35VA	
GENERAL	SDEC-3000	SDEC-4000
DIMENSIONS (H x W x D):	1-3/4" x 19" x 9-1/4" (44MM x 483MM x 235MM)	3-1/2" x 19" x 9-1/4" (89MM x 483MM x 235MM)
WEIGHT:	6.5 LB (3KG)	13 LB (6KG)

All features and specifications are subject to change without notice.

JBL, JBL Synthesis and Synthesis are trademarks of Harman International Industries, Incorporated, registered in the United States and/or other countries. London Architect is a trademark of Harman International Industries, Incorporated.

THX Ultra2 is a trademark of THX Ltd. All rights reserved.

CobraNet is a registered trademark of Peak Audio, a division of Cirrus Logic, Inc.



Harman Consumer Group, Inc.
250 Crossways Park Drive
Woodbury, NY 11797

8500 Balboa Boulevard
Northridge, CA 91329
818.830.8757

www.jblsynthesis.com

H A Harman International Company

Part No. SDEC3000/4000 OM 10/06

Declaration of Conformity



We, Harman Consumer Group International
2, route de Tours
72500 Château du Loir
France

declare in own responsibility that the products
described in this owner's manual are in compliance
with technical standards:

EN 61000-6-3:2001
EN 61000-6-1:2001

Luc Guillaume
Harman Consumer Group International
Château du Loir, France 10/06

Free Manuals Download Website

<http://myh66.com>

<http://usermanuals.us>

<http://www.somanuals.com>

<http://www.4manuals.cc>

<http://www.manual-lib.com>

<http://www.404manual.com>

<http://www.luxmanual.com>

<http://aubethermostatmanual.com>

Golf course search by state

<http://golfingnear.com>

Email search by domain

<http://emailbydomain.com>

Auto manuals search

<http://auto.somanuals.com>

TV manuals search

<http://tv.somanuals.com>