

JBL

Simply Cinema[®]



ESC350 simple setup guide

Table of Contents

- Important Safety Precautions 3
- 1. Speaker Placement 4
 - Mounting Options 5
 - Remote-Control-Battery Installation 5
- 2. Connections 6
 - Connect TV or VCR to The Source™ 6
 - Connect Antennas to The Source 6
 - Connect Optional Cassette Deck to The Source 6
 - Connect The Source to a Subwoofer 6
 - Speaker Connection Tips 7
- 3. Operations 8
 - Volume 8
 - Mute 8
 - Bass 9
 - Treble 9
- CD Operation 10
 - To Play a CD 10
 - To Skip to a Different Track 10
 - To Scan within the Same Track 10
 - To Pause the CD 11
 - To Stop the CD 11
 - To Program the CD 11
 - To Play the Tracks of a CD in Random Order 11
 - To Repeat the Disc 11
- Tuner Operation 12
 - To Switch Between AM and FM 12
 - To Tune to a Particular Station 12
 - If a Selected FM Station is a Little Noisy 13
 - To Have the Tuner Search for the Next Strong Station 13
- Preset Operation 14
- Surround Mode Operation 15
- Test Tone 16
 - Balance 16
 - Center-Channel Volume 16
 - Rear-Channel Volume 16
 - Delay Time 17
- Troubleshooting 18
- Specifications 19

thank you for choosing JBL. For more than 50 years, JBL has been involved in every aspect of music and film recording and reproduction, from live performances to monitoring the recordings you play in your home, car or office.

We're confident that the JBL system you have chosen will provide every note of enjoyment that you expected – and that when you think about purchasing additional audio equipment for your home, car or office, you will once again choose JBL.

Please take a moment to complete the enclosed profile card. It enables us to keep you posted on our latest advancements, and helps us to better understand our customers and build products that meet their needs and expectations.

JBL Consumer Products

read first! Important Safety Precautions!

CAUTION
RISK OF ELECTRIC SHOCK
DO NOT OPEN

CAUTION: To prevent electric shock, do not remove the grounding plug on the power cord, or use any plug or extension cord that does not have a grounding plug provided.

Make certain that the AC outlet is properly grounded. Do not use an adapter plug with this product.

The lightning flash with arrowhead symbol, within an equilateral triangle, is intended to alert the user to the presence of uninsulated "dangerous voltage" within the product's enclosure that may be of sufficient magnitude to constitute a risk of electric shock to persons.

The exclamation point within an equilateral triangle is intended to alert the user to the presence of important operating and maintenance (servicing) instructions in the literature accompanying the appliance.

- 1. Read Instructions.** All the safety and operating instructions should be read before the product is operated.
- 2. Retain Instructions.** The safety and operating instructions should be retained for future reference.
- 3. Heed Warnings.** All warnings on the product and in the operating instructions should be adhered to.
- 4. Follow Instructions.** All operating and use instructions should be followed.
- 5. Cleaning.** Unplug this product from the wall outlet before cleaning. Do not use liquid cleaners or aerosol cleaners. Use a damp cloth for cleaning.
- 6. Attachments.** Do not use attachments not recommended by the product manufacturer, as they may cause hazards.
- 7. Water and Moisture.** Do not use this product near water – for example, near a bathtub, wash bowl, kitchen sink or laundry tub; in a wet

basement; or near a swimming pool; or the like.

8. Accessories. Do not place this product on an unstable cart, stand, tripod, bracket or table. The product may fall, causing serious injury to a child or adult, and serious damage to the product. Use only with a cart, stand, tripod, bracket or table recommended by the manufacturer, or sold with the product. Any mounting of the product should follow the manufacturer's instructions, and should use a mounting accessory recommended by the manufacturer.

9. A Product and Cart Combination Should Be



Moved with Care. Quick stops, excessive force and uneven surfaces may cause the product and cart combination to overturn.

10. Ventilation. Slots and openings in the cabinet are provided for ventilation and to ensure reliable operation of the product and to protect it from overheating, and these openings must not be blocked or covered. The openings should never be blocked by placing the product on a bed, sofa, rug or other similar surface. This product should not be placed in a built-in installation, such as a bookcase or rack, unless proper ventilation is provided or the manufacturer's instructions have been adhered to.

11. Power Sources. This product should be operated only from the type of power source indicated on the marking label. If you are not sure

of the type of power supply to your home, consult your product dealer or local power company. For products intended to operate from battery power, or other sources, refer to the operating instructions.

12. Grounding or Polarization. This product may be equipped with a polarized alternating-current-line plug (a plug having one blade wider than the other). This plug will fit into the power outlet only one way. This is a safety feature. If you are unable to insert the plug fully into the outlet, try reversing the plug. If the plug should still fail to fit, contact your electrician to replace your obsolete outlet. Do not defeat the safety purpose of the polarized plug.

13. Power-Cord Protection. Power-supply cords should be routed so that they are not likely to be walked on or pinched by items placed upon or against them, paying particular attention to cords at plugs, convenience receptacles, and the point where they exit from the product.

14. Nonuse Periods. The power cord of the product should be unplugged from the outlet when left unused for long periods of time.

15. Outdoor Antenna Grounding. If an outside antenna or cable system is connected to the product, be sure the antenna or cable system is grounded so as to provide some protection against voltage surges and built-up static charges. Article 810 of the National Electrical Code, ANSI/NFPA 70, provides infor-

mation with regard to proper grounding of the mast and supporting structure, grounding of the lead-in wire to an antenna discharge unit, size of grounding conductors, location of antenna-discharge unit, connection to grounding electrodes, and requirements for the grounding electrode. See Figure 1.

16. Lightning. For added protection for this product during a lightning storm, or when it is left unattended and unused for long periods of time, unplug it from the wall outlet and disconnect the antenna or cable system. This will prevent damage to the product due to lightning and power-line surges.

17. Power Lines. An outside antenna system should not be located in the vicinity of overhead power lines or other electric light or power circuits, or where it can fall into such power lines or circuits. When installing an outside antenna system, extreme care should be taken to keep from touching such power lines or circuits, as contact with them might be fatal.

18. Overloading. Do not overload wall outlets, extension cords, or integral convenience receptacles, as this can result in a risk of fire or electric shock.

19. Object and Liquid Entry. Never push objects of any kind into this product through openings, as they may touch dangerous voltage points or short-out parts that could result in a fire or electric shock. Never spill liquid of any kind on the product.

20. Servicing. Do not attempt to service this product yourself, as opening or removing covers may expose you to dangerous voltage or other hazards. Refer all servicing to qualified service personnel.

21. Damage Requiring Service. Unplug this product from the wall outlet and refer servicing to qualified service personnel under the following conditions:

- The power-supply cord or the plug has been damaged; or
- Objects have fallen onto, or liquid has been spilled into, the product; or
- The product has been exposed to rain or water; or
- The product does not operate normally when following the operating instructions. Adjust only those controls that are covered by the operating instructions, as an improper adjustment of other controls may result in damage and will often require extensive work by a qualified technician to restore the product to its normal operation; or
- The product has been dropped or damaged in any way; or

f. The product exhibits a distinct change in performance; this indicates a need for service.

22. Replacement Parts. When replacement parts are required, be sure the service technician has used replacement parts specified by the manufacturer or that have the same characteristics as the original part. Unauthorized substitutions may result in fire, electric shock or other hazards.

23. Safety Check. Upon completion of any service or repairs to this product, ask the service technician to perform safety checks to determine that the product is in proper operating condition.

24. Wall or Ceiling Mounting. The product should be mounted to a wall or ceiling only as recommended by the manufacturer.

25. Heat. The product should be situated away from heat sources such as radiators, heat registers, stoves or other products (including amplifiers) that produce heat.

Figure 1.
Example of Antenna Grounding as per National Electrical Code, ANSI/NFPA 70

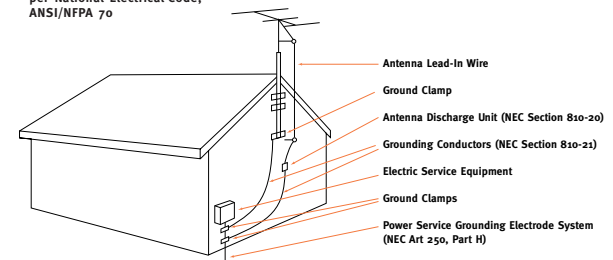

Part No. JBULB 6/96

included

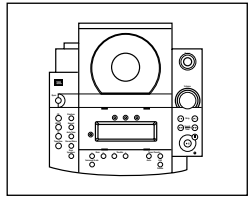

The Source™

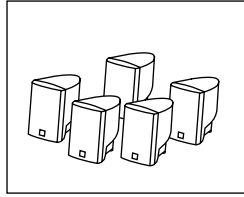

Five satellites for left, right, center and surrounds.

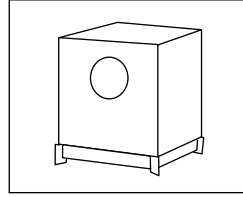

Powered subwoofer containing all amplification.

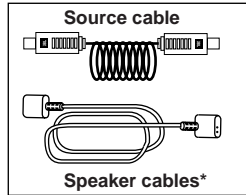

*3 x 20' - front.
*2 x 40' - surround.

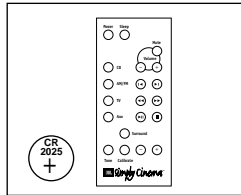

Remote with battery.

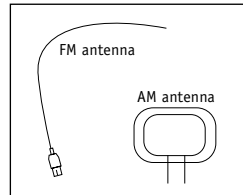

FM and AM antennas.

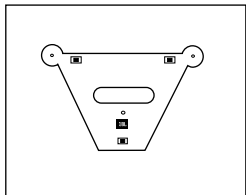

Wall bracket for The Source.

one. Speaker Placement

Satellites

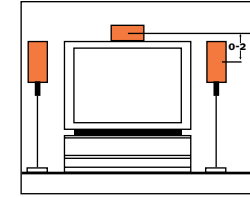
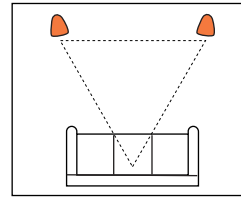

Subwoofer

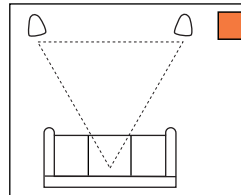

Surround Speakers

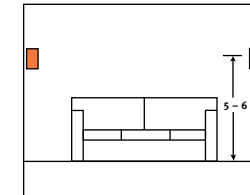
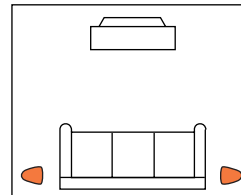

Mounting Options

Satellites and Surrounds

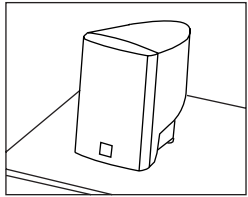

On shelves.

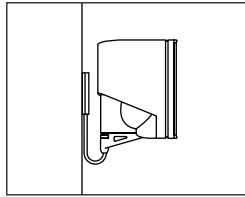

On the wall. Optional brackets, WB300.

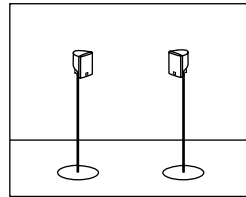

On optional stands, FS300.

Mounting to Wall

Using optional wall-mount brackets.

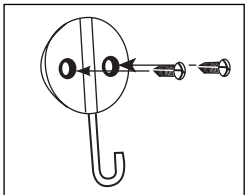

1. Attach plate to wall.

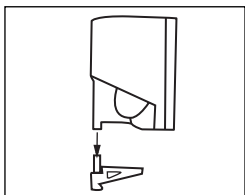

2. Slide speaker onto support.

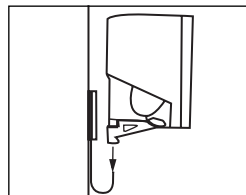

3. Place speaker and support on wall plate.

The customer is responsible for proper selection and use of mounting hardware, available through hardware stores, to properly and safely wall-mount the speakers.

Remote-Control-Battery Installation

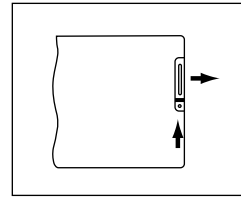

Push small tab towards battery slot and pull battery drawer out.

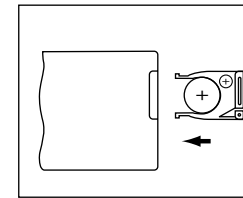

Remove old battery.

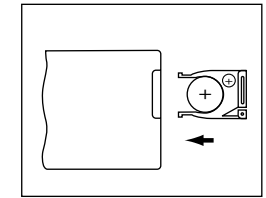

Insert new battery with "+" side up, and slide battery drawer back into remote.

two. Connections

Connect TV or VCR to The Source

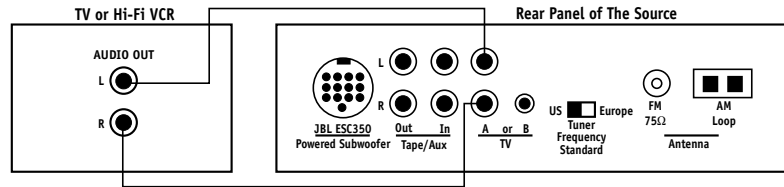

Note: The Source also provides a stereo mini-jack (B) to provide an easy connection to devices that have a stereo mini-jack audio output.

Connect Antennas to The Source

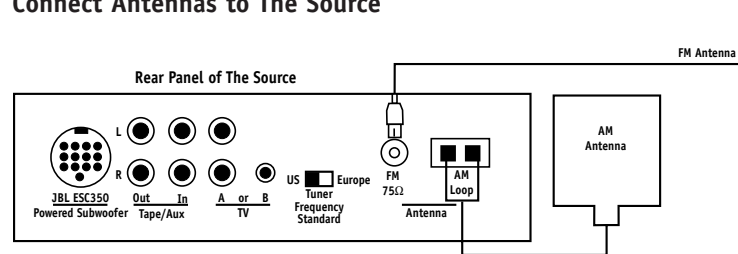

Connect Optional Cassette Deck to The Source

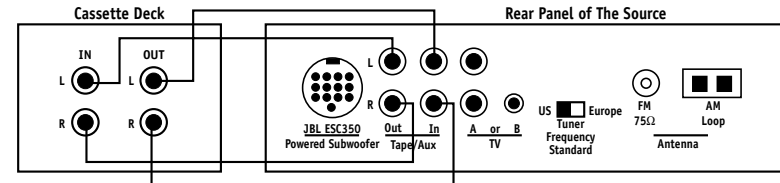

Connect The Source to a Subwoofer

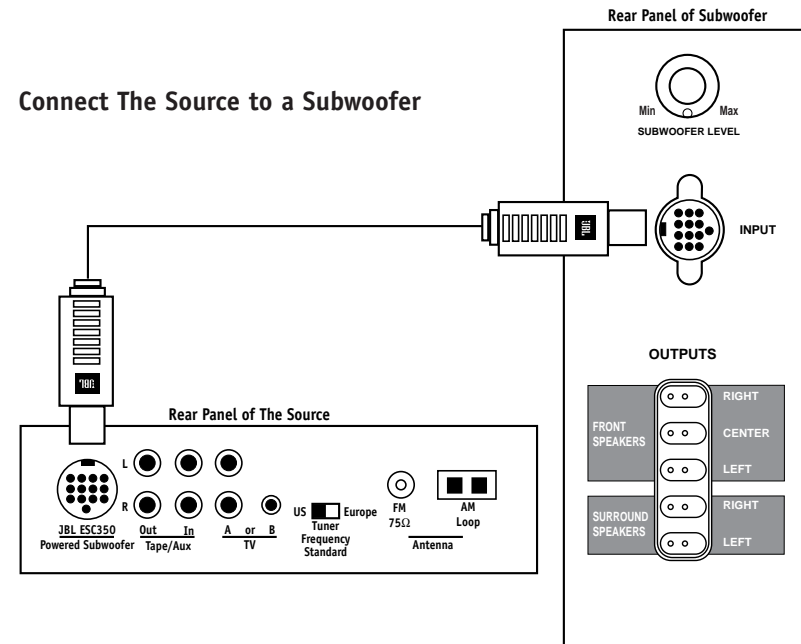

Speaker Connections

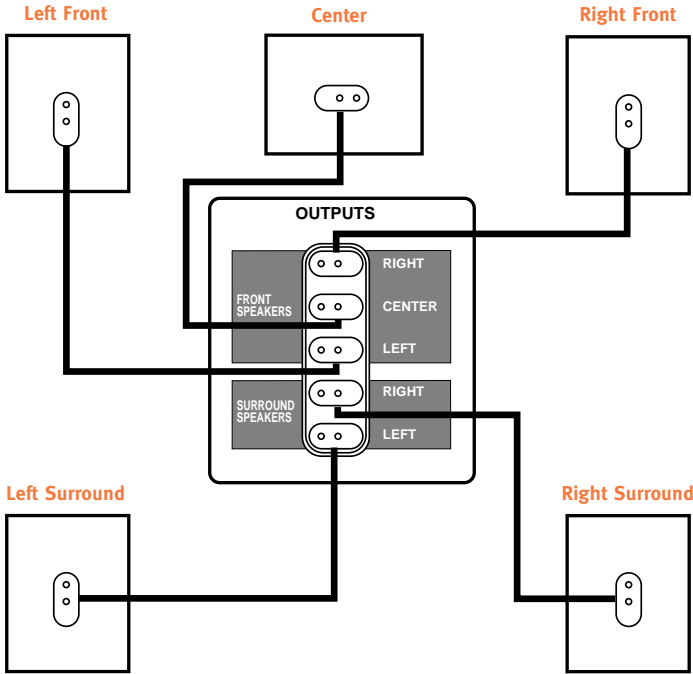

Speaker and Amplifier Connection

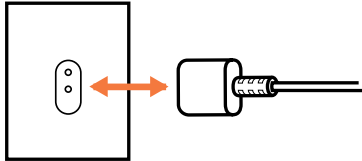

three. Operations

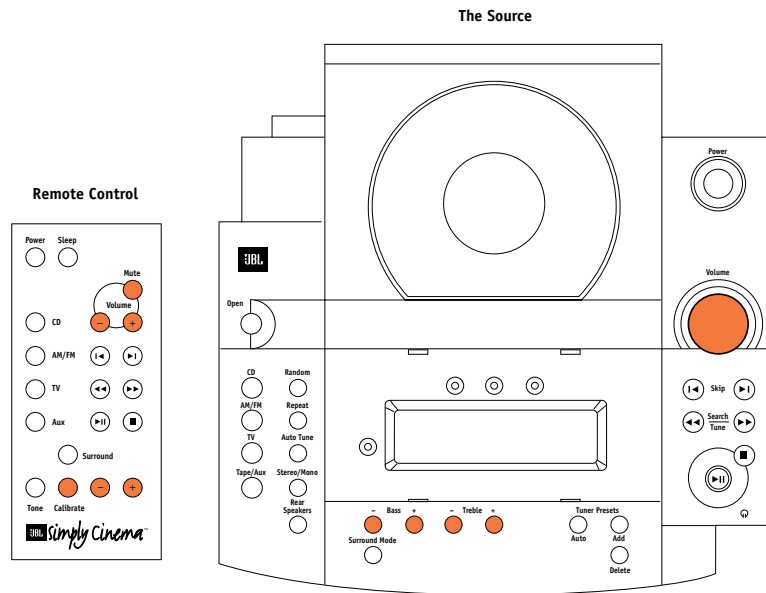

Volume

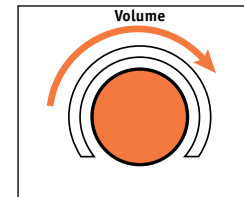

THE SOURCE
To raise volume:
Turn control on The Source
clockwise or

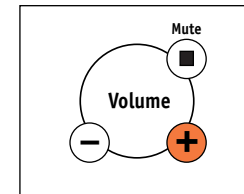

REMOTE
push "+" on the remote
control.

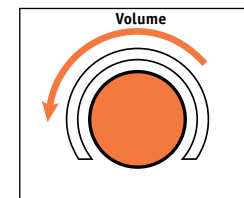

THE SOURCE
To lower volume:
Turn volume control
on The Source counter-
clockwise or

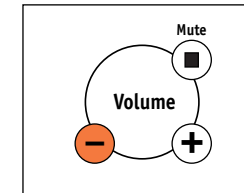

REMOTE
push "-" on the remote
control.

Mute

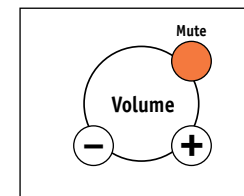

REMOTE

To lower volume
completely: Push "Mute"
on the remote control.
When "Mute" is pushed
again, the volume will
return to its original level.

Bass

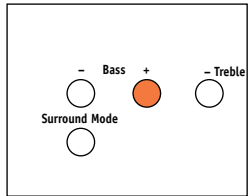

THE SOURCE
To raise the bass level:
Push "+" on The Source or

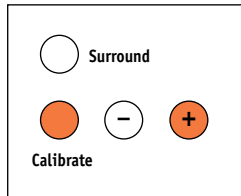

REMOTE
push "Calibrate" on the
remote control until "Bass"
illuminates in The Source
display. Push "+" until you
reach the desired level.

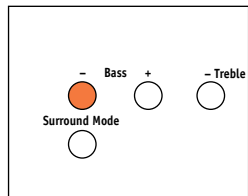

THE SOURCE
To lower the bass level:
Push "-" on The Source or

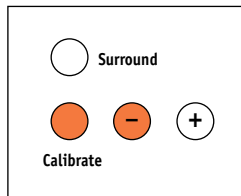

REMOTE
push "Calibrate" on the
remote control until "Bass"
illuminates in The Source
display. Push "-" until you
reach the desired level.

Treble

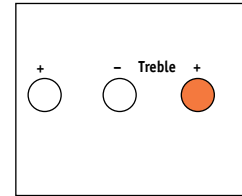

THE SOURCE
To raise the treble level:
Push "+" on The Source or

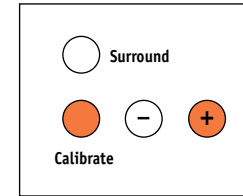

REMOTE
push "Calibrate" on the
remote control until "Treble"
illuminates in The Source
display. Push "+" until you
reach the desired level.

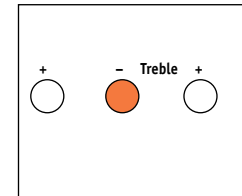

THE SOURCE
To lower the treble level:
Push "-" on The Source or

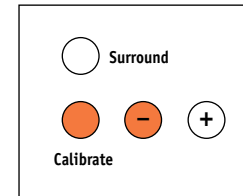

REMOTE
push "Calibrate" on the
remote control until "Treble"
illuminates in The Source
display. Push "-" until you
reach the desired level.

CD Operation

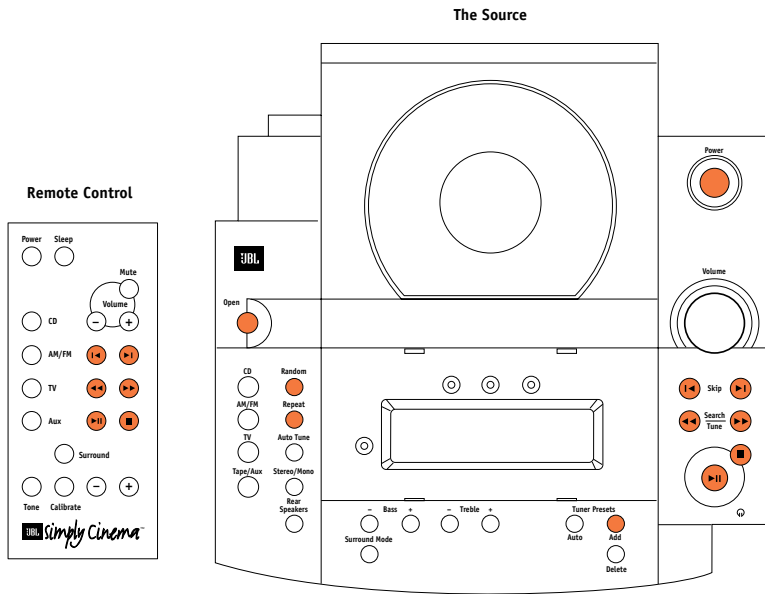

To Play a CD

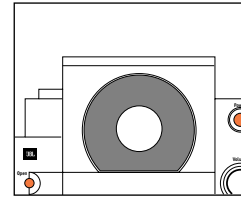

THE SOURCE

1. Push "Power" and/or "Open" on The Source.
2. Insert CD.

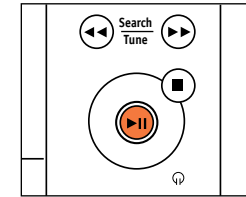

THE SOURCE

3. Push "Play" on The Source or

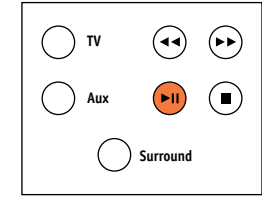

REMOTE

the remote control.
(The door will close automatically.)

To Skip to a Different Track

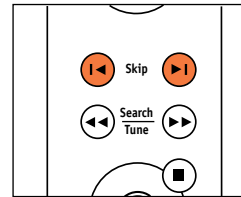

THE SOURCE

Push "1<" or ">1" on The Source or

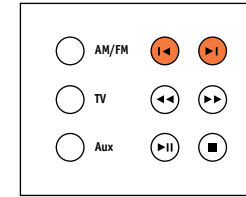

REMOTE

the remote control until the number of the desired track appears on the display.

To Scan within the Same Track

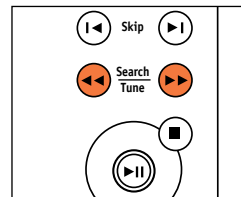

THE SOURCE

Push "<<" or ">>" on The Source or

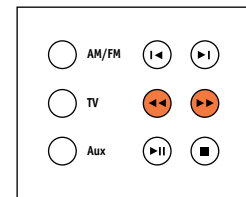

REMOTE

the remote control.

To Pause the CD

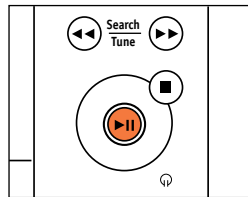

THE SOURCE

Push "Pause" on The Source or

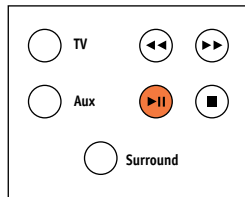

REMOTE

the remote control. Push again to resume play.

To Stop the CD

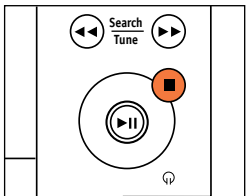

THE SOURCE

Push "Stop" on The Source or

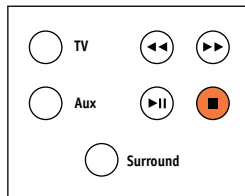

REMOTE

the remote control.

To Program the CD

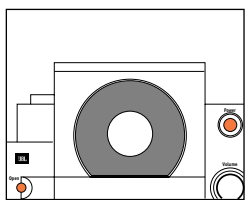

THE SOURCE

1. Push "Power" and/or "Open" on The Source.
2. Insert CD.

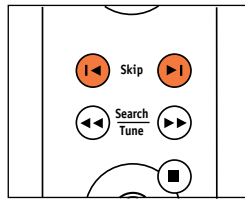

THE SOURCE

3. Push "<" or ">" to select desired track.

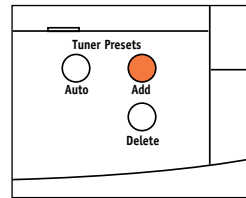

THE SOURCE

4. Push "Add" to program track. Repeat procedure until all desired tracks are programmed.

To Play the Tracks of a CD in Random Order

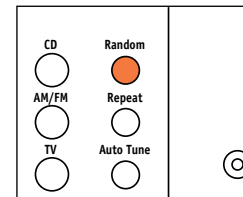

THE SOURCE

Push "Random" on The Source. The Source will automatically delete each track it has played from the "Random" operation.

To Repeat the Disc

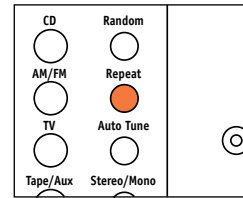

THE SOURCE

Push "Repeat" on The Source.

Note: If "Random" and "Repeat" are both engaged the CD player will randomly play the disc, deleting all played tracks, until the disc is finished. It will then randomly play the disc again.

Tuner Operation

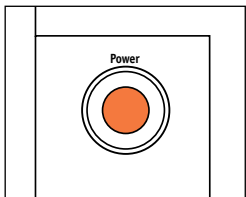
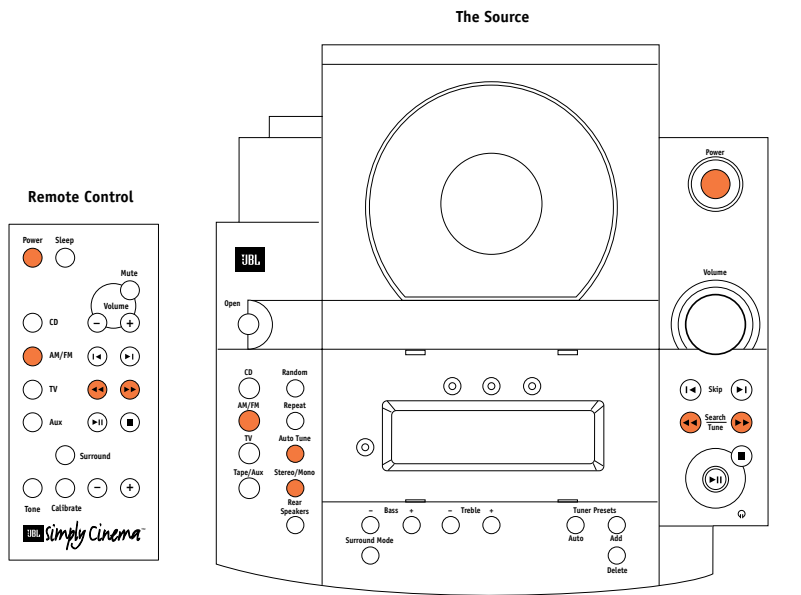

THE SOURCE
Push "Power" on The Source
or

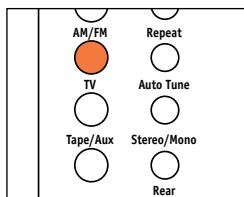

THE SOURCE
"AM/FM" on The Source or

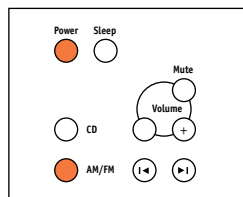

REMOTE
the remote control.

To Switch Between AM and FM

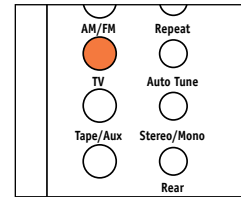

THE SOURCE
Push "AM/FM" on
The Source or

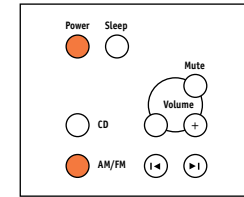

REMOTE
the remote control.

To Tune to a Particular Station

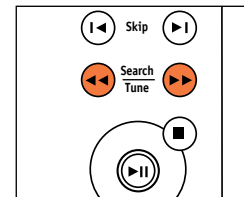

THE SOURCE
Push "<<" or ">>" on
The Source or

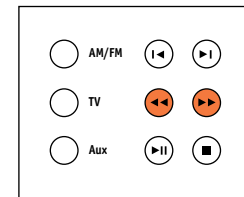

REMOTE
the remote control. To
search rapidly, hold down
the "<<" or ">>" button.

If a Selected FM Station is a Little Noisy

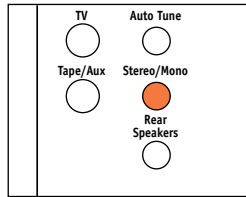

THE SOURCE

Push "Stereo/Mono" on The Source. This will play the selected station without any stereo separation, but there will be much less background noise.

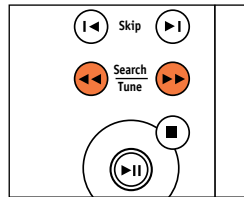

THE SOURCE

When in the "Mono" mode, the "<<" or ">>" on The Source or

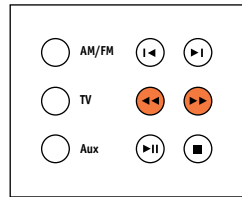

REMOTE

the remote control will tune up or down one frequency at a time.

To Have the Tuner Search for the Next Strong Station

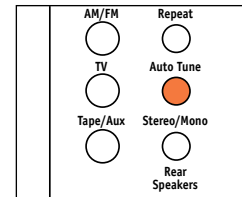

THE SOURCE

Push "Auto Tune" on The Source.

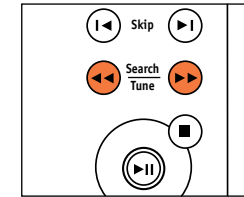

THE SOURCE

Then, when you push "<<" or ">>" on The Source or

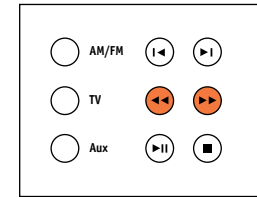

REMOTE

the remote control, the tuner will automatically advance to the next station with a strong signal.

Preset Operation

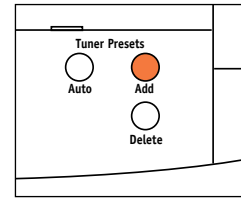
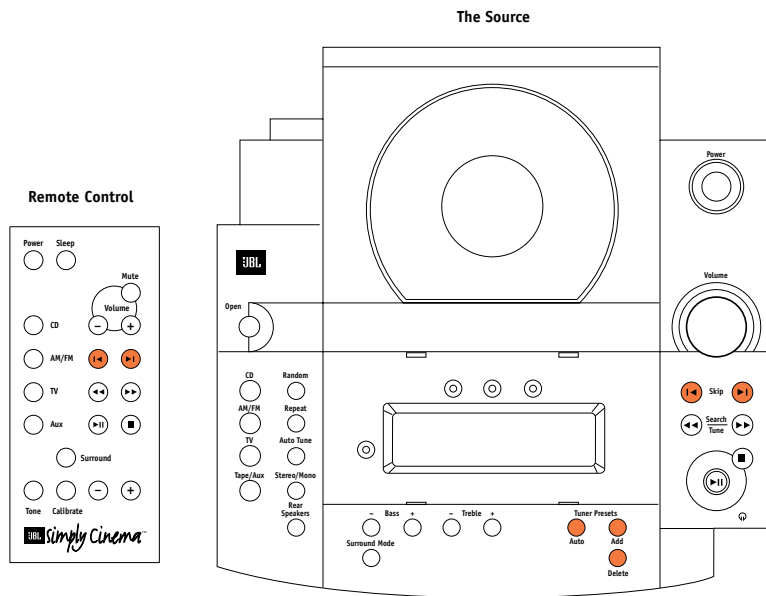

THE SOURCE

1. Tune to the station that you want to add into memory.
2. Push "Add" on The Source. That station is now added to your selection of stations in memory.

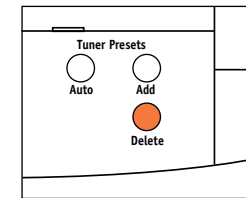

THE SOURCE

3. To delete a preset: Push "Delete" on The Source. That station is now removed from your selection of stations in memory.

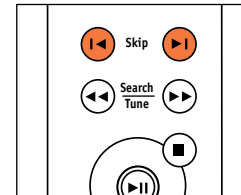

THE SOURCE

4. To skip between preset stations: Push "I<" or "I>" on The Source or

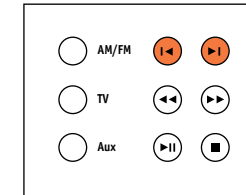

REMOTE

- the remote control.

The Source has a unique feature that will automatically place up to 32 stations in memory. To activate this feature, push and hold the "Auto" button for one second. The tuner will search the dial and place the stations with a strong signal into memory.

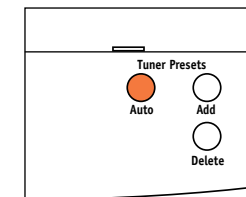

THE SOURCE

Note: Activating this feature will delete all stations that were previously stored in memory. To prevent this from accidentally occurring, the Auto button will only activate if held for a full second.

Surround Mode Operation

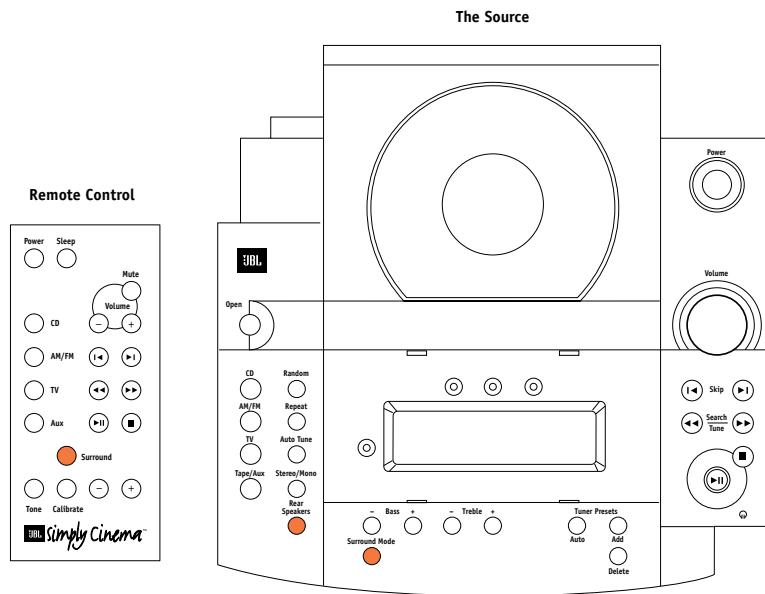

What is Dolby* Pro Logic*?

Dolby* Pro Logic* is an encode/decode process by which four channels of sound-track information are encoded into two channels for playback on VCRs, laser disc players, and some TV broadcasts, and then decoded back

into four channels for playback through five loudspeakers. Remember that a Dolby Pro Logic system consists of three channels of information for front left, center, and right speakers and one channel of mono surround

information. The surround channel is played back through two speakers. Dolby Pro Logic helps to re-create all of the impact and excitement of a movie theater in your home.

This system contains three surround modes.

1. Dolby Pro Logic – In this mode all five speakers are used.
2. Dolby Pro Logic Phantom – In this mode the center channel does not operate. This may be preferred when listening to a music source that was not recorded with surround-channel information.
3. 2-channel – In this mode the program is played back in a traditional stereo form.

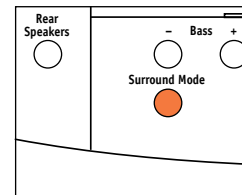

THE SOURCE

To switch between the three surround modes: Push "Surround Mode" on The Source or

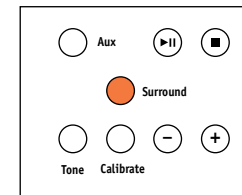

REMOTE

the remote control.

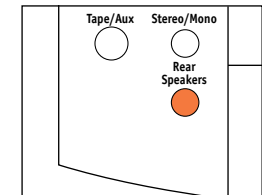

THE SOURCE

If you are listening to a program in the Dolby Pro Logic Normal or Phantom mode and you wish to turn off the surround speakers: Push "Rear Speakers" on The Source.

Test Tone

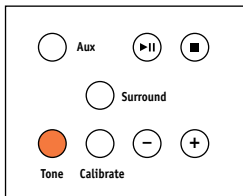
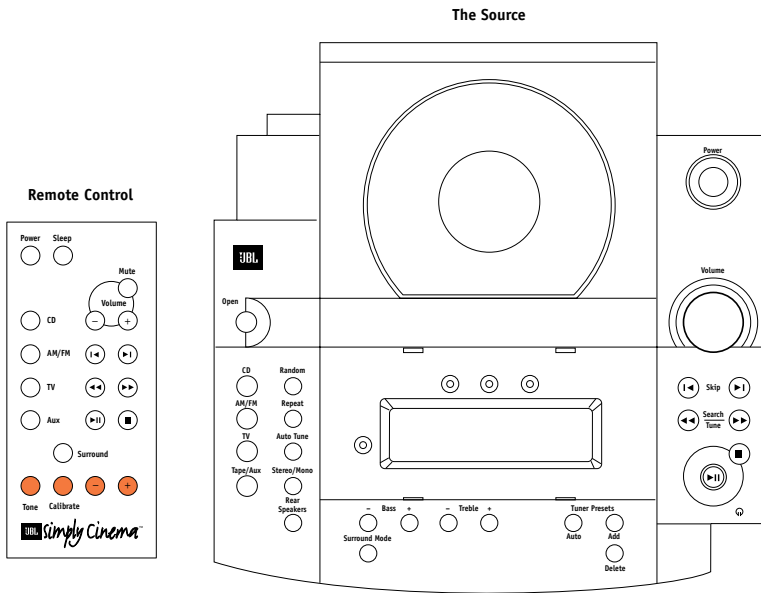

THE SOURCE

For proper Dolby Pro Logic operation, a test tone is used to calibrate the volume settings of the speakers. A noise will be

heard cycling, in order, from the front left, center, right, and both surround speakers.

Using the remote control, push "Tone." Then adjust the Center and Surround levels until the volume of all the speakers is the same during the test. *Note:* The test tone is

used to calibrate the performance of the system. When listening to an actual recording, the volume level of the surround channels is generally much lower than that of the front channels.

In fact, when listening to a movie, virtually all of the dialogue and a substantial number of the effects are reproduced through the center channel.

Balance

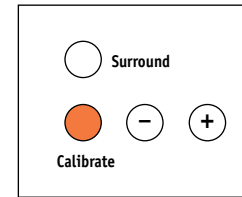

REMOTE

Push "Calibrate" on the remote control until "Balance" appears in the display.

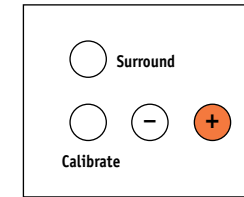

REMOTE

Push "+" on the remote control to adjust the balance toward the right speaker.

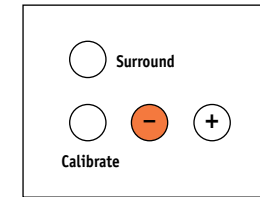

REMOTE

Push "-" on the remote control to adjust the balance toward the left speaker.

Center-Channel Volume

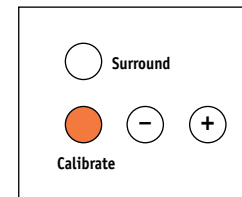

REMOTE

Push "Calibrate" on the remote control until "Center" appears in the display and the corresponding LED on top of the display is lit.

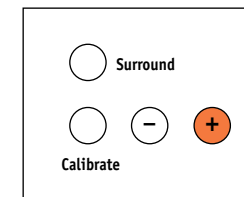

REMOTE

Push "+" on the remote control to increase the volume of the center channel.

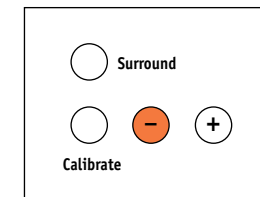

REMOTE

Push "-" on the remote control to decrease the volume of the center channel.

Rear-Channel Volume

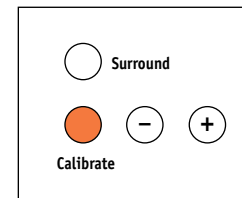

REMOTE

Push "Calibrate" on the remote control until "Rear" appears in the display and the corresponding LED on top of the display is lit.

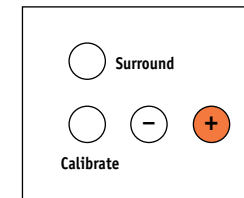

REMOTE

Push "+" on the remote control to increase the volume of the rear channels.

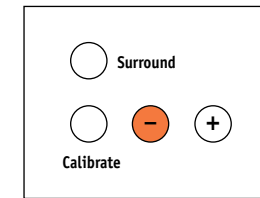

REMOTE

Push "-" on the remote control to decrease the volume of the rear channels.

Delay Time

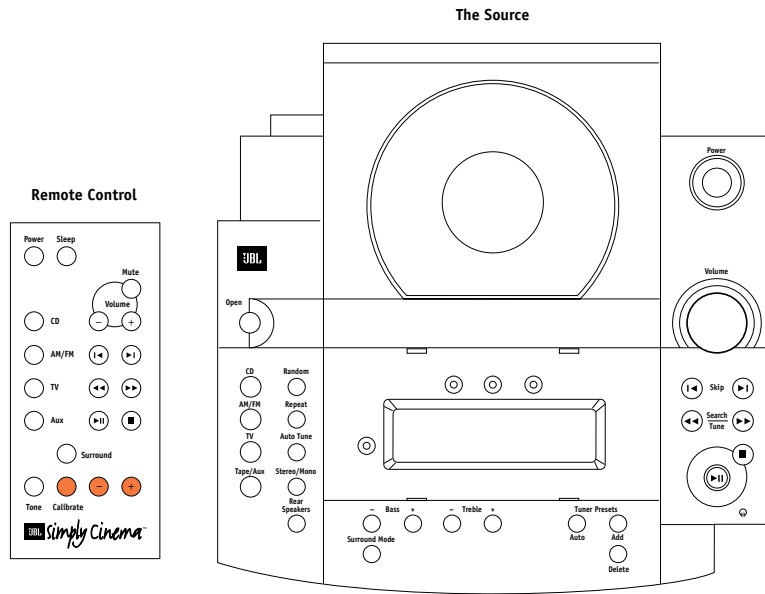

The delay control allows the user to set the surround delay between 15 and 30 milliseconds in one-millisecond increments.

The best setting will depend on the distance between the main listening area and the front speakers as well as

the distance between the main listening area and the rear speakers. The chart at the bottom shows the recommended settings.

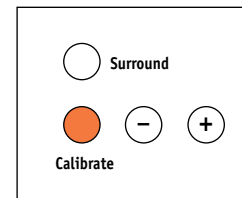
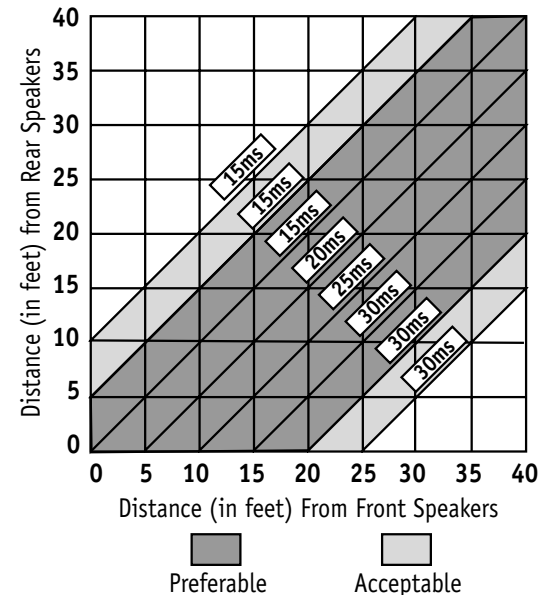

REMOTE

Push "Calibrate" on the remote control until "Delay" appears in the display and the corresponding LED on top of the display is lit.

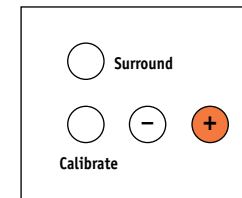

REMOTE

Push "+" on the remote control to increase the delay time.

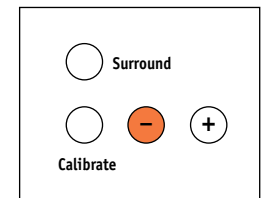

REMOTE

Push "-" on the remote control to decrease the delay time.

Troubleshooting

If there is no sound from any of the speakers, check the following:

- Make sure the subwoofer is plugged into an active AC wall outlet.
- Make sure the Master Power Switch, located on the rear of the subwoofer, is in the "On/Standby" position.
- Make sure there is a source – for example, a VCR or television – hooked up to the TV or tape/aux input jacks on The Source.
- Make sure that the program material is playing.
- Recheck the hookup connections.

If most of the sound comes from the center-channel speaker, with little or no information from the surround channels, note the following:

Although most of today's televisions are equipped with stereo audio output jacks, some stereo televisions have poor audio sections and are unable to provide a Dolby Pro Logic encoded signal. In the unlikely event that you experi-

ence this problem, connecting the audio outputs from your hi-fi VCR, laser disc player, DVD player, or satellite receiver directly to one of the inputs on The Source will provide a proper audio signal and allow you to enjoy true Dolby Pro Logic surround sound.

If there is no sound from the surround speakers or sound is very low, check the following:

- Check all connections between the amplifier and each of the speakers.
- Raise the surround volume from the remote control (see "Operation" section).
- Make sure the TV show or movie you are watching is recorded in Dolby Surround.

If there is no sound from the center speaker, check the following:

- Make sure that the processor is in the Pro Logic mode. If it is in Phantom or Stereo mode, the center speaker will not play.
- Check the connections between the subwoofer and the center speaker.

If you have low bass output, check the following:

- Experiment with placement of the subwoofer. Remember, place the subwoofer in a corner to get maximum bass output from the system.
- Increase the level of bass, using the remote control.
- Adjust the level control on the rear of the subwoofer.

If you are having trouble picking up radio stations, check the following:

- Make sure the antenna is hooked up properly.
- Depending on your distance from the station's transmitter, you may need to install an FM antenna on the roof or in the attic.

Specifications

Components

The Source

surround sound processor,
CD player, AM/FM tuner

Subwoofer

8" driver in a bass-reflex
enclosure

Satellite Speakers

3/4" tweeters,
3" midrange driver

System Remote

credit-card-sized
hand-held controller

ESC350 System

Amplifier

200 watts total system output;
front channels:

35 watts x 3 @ .1% THD;
surround channels:

15 watts x 2 @ .1% THD;
subwoofer:

65 watts x 1 @ 1% THD

System Frequency

Response (-6dB)

35Hz – 20kHz

Signal-to-Noise Ratio

90dB

Input Impedance

20k ohms

Input Sensitivity

250mV

The Source

Dimensions (H x W x D)

4-5/8 x 10-1/4 x 9-3/4 inches

117 x 260 x 248mm

Weight

5 lbs/2.3 kg

Subwoofer

Dimensions (H x W x D)

15-1/8 x 13 x 14-1/2 inches

384 x 330 x 368mm

Weight

34.5 lbs/15.7 kg

Satellites

Dimensions (H x W x D)

4-3/8 x 3-3/16 x 3-3/4 inches

111 x 81 x 95mm

Weight

.8 lbs/.4 kg

System Remote

Dimensions (H x W x D)

4-7/8 x 2-1/4 x 1/4 inches

124 x 57 x 6mm

Weight

.25 lbs/.11 kg

Occasional refinements
may be made to existing
products without notice,
but will always meet
or exceed original
specifications unless
otherwise stated.



JBL Consumer Products
250 Crossways Park Drive, Woodbury, NY 11797
8500 Balboa Boulevard, Northridge, CA 91329
1-800-336-4JBL (4525) (USA only)
www.jbl.com

© 1998 JBL, Incorporated. JBL and Simply Cinema are registered trademarks of JBL, Incorporated.

*Trademarks of Dolby Laboratories.

8/98 ♻️ Part No. ESC3500M

H A Harman International Company

Free Manuals Download Website

<http://myh66.com>

<http://usermanuals.us>

<http://www.somanuals.com>

<http://www.4manuals.cc>

<http://www.manual-lib.com>

<http://www.404manual.com>

<http://www.luxmanual.com>

<http://aubethermostatmanual.com>

Golf course search by state

<http://golfingnear.com>

Email search by domain

<http://emailbydomain.com>

Auto manuals search

<http://auto.somanuals.com>

TV manuals search

<http://tv.somanuals.com>