

SR-X
series

SR-X Series Users Guide



CONTENTS

Before You Begin - Important Information..... 3

Product Range..... 4-6

Specifications and Recommended Power..... 7

Cable and Connections..... 8

Input Panel..... 9

Input Configurations..... 10-11

Crossovers and Controllers..... 12

System Configurations..... 13

SR-X/F Flying Versions..... 14-15

JBL Warranty and Contact Information..... 16

Explanation of Graphic Symbols



The exclamation point within an equilateral triangle is intended to alert the users to the presence of important operating and maintenance (servicing) instructions in the literature accompanying the product.



The lightning flash with the arrowhead symbol, within an equilateral triangle, is to alert the user to the presence of insulated "dangerous voltage" within the products enclosure that may be of sufficient magnitude to constitute a risk of electric shock to humans.



CAUTION: TO REDUCE THE RISK OF ELECTRONIC SHOCK - DO NOT REMOVE COVER. NO USER SERVICEABLE PARTS INSIDE. REFER SERVICING TO QUALIFIED PERSONNEL.



ATTENTION: POUR ÉVITER LES RISQUES DE CHOC ÉLECTRIQUE, NE PAS ENLEVER LE COUVERCLE. AUCUN ENTRETIEN DE PIÈCES INTÉRIEURES PAR L'USAGER. CONFIER L'ENTRETIEN AU PERSONNEL QUALIFIÉ. AVIS: POUR ÉVITER LES RISQUES D'INCENDIE OU D'ÉLECTROCUTION, N'EXPOSEZ PAS CET ARTICLE À LA PLUIE OU À L'HUMIDITÉ.



The IEC fuse symbol pictured at the left represents an approved user replaceable fuse. When replacing a fuse, make sure to replace with only the correct type and fuse rating.

Important Safety Instructions

1. Read these instructions.
2. Keep these instructions.
3. Heed all warnings
4. Follow all instructions
5. Do not use this apparatus near water.
6. Clean only with a dry cloth.
7. Do not block any ventilation openings. Install in accordance with manufacturers instructions.
8. Do not install near any heat sources such as radiators, heat registers, stoves, or other apparatus that produce heat.
9. Do not defeat the safety purpose of the polarized or grounding-type plug. A polarized plug has two blades with one wider than the other. A grounding-type has two blades and a third grounding prong. The wide blade or the third prong is provided for your safety. If the provided plug does not fit your outlet, consult a electrician for replacement of the obsolete outlet.
10. Protect the power cord from being walked on or pinched, particularly at plugs, convenience receptacles, and the point where they exit the apparatus.
11. Only use attachments / accessories specified by the manufacturer.
12. Use only with a cart, stand, bracket, or table specified by the manufacturer or sold with the apparatus. When a cart is used, use caution when moving the cart / apparatus combination to avoid injury from tip-over. 
13. Unplug this apparatus during lightning storms or when un-used for long periods of time.
14. Refer all servicing to qualified service personnel. Servicing is required when a apparatus has been damaged in any way, such as power-cord or plug is damaged, liquid has been spilled, or objects have fallen into the apparatus, the apparatus has been exposed to rain or moisture, does not operate normally, or has been dropped.
15. To reduce the risk of fire or electric shock, do not expose this apparatus to rain or moisture.

BEFORE YOU BEGIN

Welcome to the family of discerning sound equipment users who have selected JBL Professional loudspeakers. This Users Guide contains important information that will help you get the most from your JBL speakers so please take a few moments to read it and be sure to keep it in a safe place for future reference.

Important Information

Before using your SR-X Series speaker system, please review the following for important information on safety and protection of your investment in quality loudspeakers.

Rigging / Suspending SR-X Products

SR-X Series speakers are designed for portable applications in which the speakers will be stacked directly on the floor, stage, speaker stands (SR4702X, SR4722X only), other speakers, or a solid, stable platform. SR-X Series speakers have no provisions for hanging, rigging or suspension.

SR-X/F Series speakers are similar to SR-X and in addition have provisions for flying.

SR-X/F versions should always be substituted for SR-X if flying or suspending the speaker system is required. **ONLY SPEAKERS SPECIFICALLY DESIGNED FOR FLYING / RIGGING SHOULD BE SUSPENDED.** For further information on suspending speakers contact JBL and request Technical Note Volume 1, Number 14 - "Basic Principles for Suspending Loudspeaker Systems".

Stand Mounting

Some SR-X models (SR4702X, SR4722X) include a receptacle cup to facilitate mounting on tripod stands. When using these stands, be sure to observe the following precautions:

- Check the stand specification to be certain it is designed to support the weight of the speaker. Observe all safety precautions specified by the stand manufacturer.
- Always verify that the stand is placed on a flat, level, and stable surface.
- Route cables so that performers, crew, and audience will not trip over them and pull the speaker over.
- Be sure to fully extend the legs of tripod type stands.
- Position the stand so that the legs do not present a trip hazard.
- Do not attempt to place more than one speaker on a stand.
- Always be cautious in windy, outdoor conditions. It may be necessary to place additional weight (i.e. sandbags) on the base of the stand to improve stability.

Stacking Speakers

Safety precautions should be observed when stacking SR-X speakers.

- Verify that the floor or stage on which the speakers will be stacked is flat, level and solid.
- When used outdoors, be aware of winds that could tip a tall speaker stack over.
- Position the speakers to minimize the possibility that performers, crew, or audience will bump into them.
- Under extreme, high-SPL conditions it's possible that speakers on a highly polished surface can "creep." (i.e. move due to the power of the acoustic energy) Precautions should be taken so that such creeping will not result in toppling of the speaker stack.

Hearing Damage, Prolonged Exposure to Excessive SPL

SR-X series loudspeakers are easily capable of generating sound pressure levels (SPL) sufficient to cause permanent hearing damage to performers, production crew and audience members. Proper precautions should be taken to avoid prolonged exposure to SPL in excess of 85dB.

Exposure to Moisture, Outdoor Applications

While SR-X Series loudspeakers will work great for outdoor sound reinforcement, they are not "weather-proof" and are not intended for continuous exposure to extremes of humidity, temperature, salt air, or UV rays. Exposure to outdoor environmental conditions may result in premature failure of components as well as degradation to appearance.

PRODUCT RANGE

The SR-X Series consists of 11 popular configurations including subwoofers, front-of-house systems, and stage monitors. SR-X models include these features:

- Metalized polyester capacitors are used throughout (instead of cheaper electrolytics) for higher power handling and lower distortion.
- "Dual-mode" crossovers can be easily switched from full-range to bi-amplified operation. A tamper-resistant, internal mode selector provides a visible, external indication of the selected mode.
- Dual driver subwoofers may be operated in parallel or discrete mode.
- VGC™ (Vented Gap Cooling) low-frequency transducers control heat build-up to increase power handling and decrease power compression, providing more acoustic output for every watt of amplifier input.
- 13 ply birch enclosures are finished in tough DuraFlex™ that resists the inevitable scuffs and dings a hard-working speaker suffers during a life of one-nighters.
- Pure titanium diaphragm compression drivers are used in all two & three-way models for high power handling and reliability.
- Optimized Aperture™ horn/driver combinations reduce throat distortion and provide smooth frequency response.
- A non-resonant, full-length perforated metal grill provides protection for the components and a rich yet unobtrusive appearance.
- Trapezoidal enclosures (except SR4715X, SR4718X, SR4719X, SR4702X) for optimal coverage when splaying multiple cabinets.
- Family footprint on the most popular models provides ease of stacking for larger, full-range systems

Stage Monitor

SR4702X

12" two-way stage monitor: With 600 watts of power capacity and 95 dB sensitivity, the SR4702X delivers all the output needed to cut through high stage volumes. Its compact footprint won't crowd the stage and the low profile won't come between the performer and the audience. For increased flexibility, a tripod mount socket is provided to facilitate use as a front-of-house speaker. A "pass-thru" speaker connector allows cleaner connection of adjacent cabinets driven by the same amplifier.

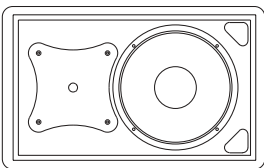

Two-Way Systems

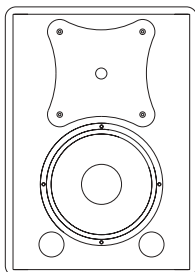

SR4722X

12" two-way compact speaker: A great choice for applications where compact size, ease of transport, and speaker stand "mountability" are required. For speech and many music uses, the SR4722X works great by itself. When more bass is needed, team it up with an SR-X Series sub-woofer. A pole-mount socket (35 mm) is provided for stand mounting.

SR4725X

15" two-way compact speaker: The 15" two-way system is a favorite for general music and speech applications. The SR4725X produces extended low frequencies in a transportable enclosure.

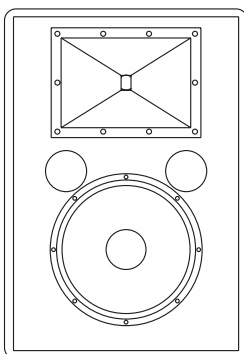
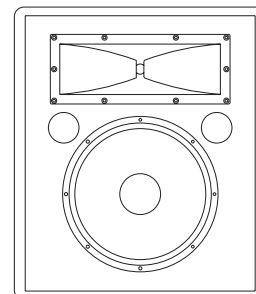

SR4726X

15" two-way high-output speaker: When the requirement is for very high acoustic output, extended low-frequency performance, and the convenience of a one-box system, choose the SR4726X. The large format 2447 compression driver coupled to an Optimized Aperture™ horn delivers great pattern control at very high levels with low distortion.

Dual LF, Two-Way Systems

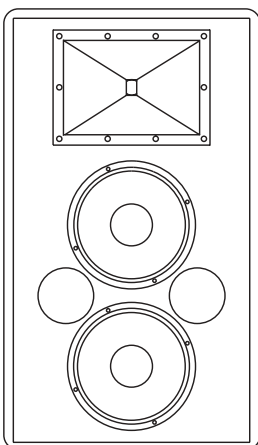

SR4731X

Dual 12" two-way system: With the combined power of two VGC LF motors and the cone area of dual 12" speakers, the SR4731X produces incredible amounts of mid-range power combined with lots of tight, punchy bass. The transition from the 12" LF drivers to the large format 2447 compression driver is very smooth. For extremely high-power applications requiring earth-moving bass, use the SR4731X over the SR4719X subwoofer.

SR4733X

Dual 15" two-way system: The SR4733X delivers the power and performance of separate subwoofer / high-mid configurations combined with the simplicity of an all-in-one system. At home in a wide range of live sound and playback applications, the SR4733X delivers very high acoustic output combined with lots of extended low bass.

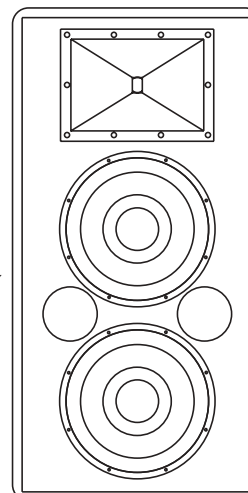

Three-Way Systems

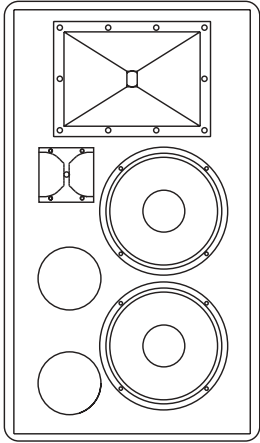

SR4732X

Dual 12" three-way system: Take the SR4731X, add the high-frequency sizzle of a 2404 UHF driver and you get the ultimate speaker system for very high-level music playback in medium to short throw applications. In combination with the SR4719X subwoofer, this is an unbeatable system for DJ and dance club applications.

SR4735X

15" three-way system: For long-throw applications in which the power and additional control of a horn-loaded cone MF driver is desired, choose the SR4735X. This system boasts extremely wide frequency response and is a great choice as an arrayable, front-of-house reinforcement system.

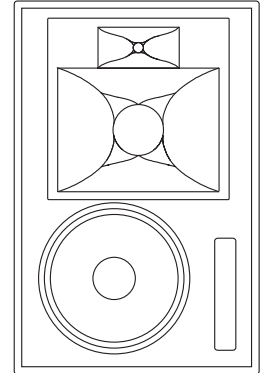

Subwoofers

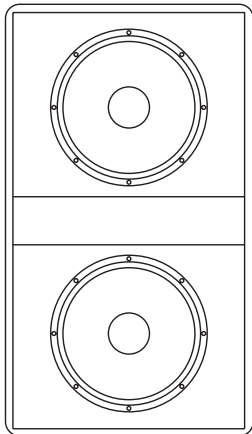

SR4715X

Dual 15" subwoofer: For those who prefer the tight, punchy bass of a 15" sub, the SR4715X is the answer. The SR4715X has the same footprint as the other SR-X 15" two-way systems (including the dual LF models) for tight floor stacking.

SR4718X

Single 18" subwoofer: The single 2241 subwoofer produces pounding bass down to 30 Hz. A top mounted, 35 mm diameter socket is provided for an optional pole (JBL model SS3-BK) to elevate a speaker such as the SR4702X or SR4722X above your subwoofer. The socket is intended to accommodate speakers up to 100 lbs (45 kg). Observe the stand mounting precautions outlined in the "Before You Begin" section of this User's Guide.

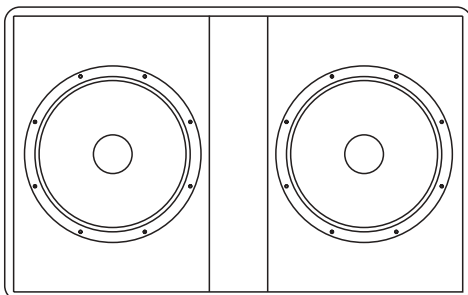
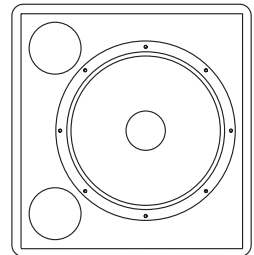

SR4719X

Dual 18" subwoofer: Capable of delivering a wall-shaking 136 dB of acoustical output with a frequency range extending to 25 Hz, the SR4719X is the choice for large rooms, outdoor performance and high-level sound reinforcement or music playback. The rectangular enclosure is ideal for stacking any of the SR-X two-way systems for those who require uncompromising high-level sound reproduction.

SPECIFICATIONS

Model	LF Driver	Mid Driver	HF	Horn	Rated Power*	System Impedance	Freq Range (-10 dB)	Crossover Frequency	Nominal Sensitivity**	Dispersion (H X V)	Weight	Shape	Dimensions
SR4702X	2206H	--	2426H	OASR	600	8	42Hz-20kHz	1.3 kHz	95dB	85° x 85°	29 kg 64 lbs	Multi-angle Monitor	648 x 403 x 356 25.5 x 15.9 x 14
SR4715X	2226H (x2)	--	--	--	1200	4	35Hz-300Hz	80 - 100 Hz recommended	100dB	--	47.2 kg 104 lbs	Rectangular	1067 x 616 x 435 42 x 24.3 x 17.1
SR4718X	2241G	--	--	--	600	4	38Hz-300Hz	80 - 100 Hz recommended	98dB	--	39.9 kg 88 lbs	Rectangular	616 x 613 x 610 mm 24.3 x 24.1 x 24 in
SR4719X	2241H (x2)	--	--	--	1200	4	30Hz-300Hz	80 - 100 Hz recommended	101dB	--	85.3 kg 188 lbs	Rectangular	765 x 1219 x 616 30.1 x 48 x 24.3
SR4722X	2206H	--	2417H	OASR	600	8	42Hz-18kHz	1.2 kHz	95dB	85° x 85°	27.2 kg 60 lbs	Trapezoidal	686 x 486 x 333 27 x 19.1 x 13.1
SR4725X	2226H	--	2426H	2370A	600	8	35Hz-18kHz	1.1 kHz	98dB	90° X 40°	37.2 kg 82 lbs	Trapezoidal	718 x 616 x 435 28.3 x 24.3 x 17.1
SR4726X	2226H	--	2447H	2381 2383	600	8	35Hz-20kHz	1.1 kHz	97dB	90° X 50° 60° X 50°	48.5 kg 107 lbs	Trapezoidal	883 x 616 x 435 34.8 x 24.3 x 17.1
SR4731X	2206H	--	2447H	2381 2383	1200	4	39Hz-20kHz	1.2 kHz	98dB	90° X 50° 60° X 50°	59.9 kg 132 lbs	Trapezoidal	1067 x 616 x 435 42 x 24.3 x 17.1
SR4732X	2206H (x2)	2447H	2404H	2381	1200	4	39Hz-21kHz	1.2 kHz, 6 kHz	98dB	90° X 50°	62.1 kg 137 lbs	Trapezoidal	1067 x 616 x 435 42 x 24.3 x 17.1
SR4733X	2226H (x2)	--	2447H	2381 2383	1200	4	37Hz-20kHz	1.2 kHz	100dB	90° X 50° 60° X 50°	65.8 kg 145 lbs	Trapezoidal	1219 x 616 x 435 48 x 24.3 x 17.1
SR4735X	2226H	M209-8A	2426H	MH1	600	8	36Hz-20kHz	340 Hz and 1.6 kHz	97dB	70° X 50°	50.8 kg 112 lbs	Trapezoidal	946 x 616 x 479 37.3 x 24.3 x 18.9

* IEC filtered random noise with a 6 dB crest factor
 **1W@1m (2.83V for 8ohms, 2.00V for 4ohms, ave'd 500Hz-5kHz)
 Specifications subject to change without notice

DuraFlex

The SR-X loudspeaker system is finished in JBL's DuraFlex™. DuraFlex is tough and inherently flexible and it is extremely resistant to knocks, scratches and scuffs. The DuraFlex finish on your SR-X speakers is actually much tougher than the plywood to which it is applied. Note: SR-X enclosures are not paintable. In the event that cosmetic damage occurs to your speakers, a DuraFlex touch-up kit (PN 16677) is available from JBL.

Recommended Power

The following table shows the recommended amplifier power for SR-X models.

Model	Full-Range / Parallel (1)	HF (2)	LF (3) / Discrete (4)
SR4702X	600 to 1,200W@8Ω	100 to 200W@8Ω	600 to 1,200W@8Ω
SR4715X	1,200 to 2,400W@4Ω	n/a	600 to 1,200W@8Ω x2
SR4718X	600 to 1,200W@4Ω	n/a	n/a
SR4719X	1,200 to 2,400W@4Ω	n/a	600 to 1,200W@8Ω x2
SR4722X	600 to 1,200W@8Ω	60 to 120W@8Ω	600 to 1,200W@8Ω
SR4725X	600 to 1,200W@8Ω	100 to 200W@8Ω	600 to 1,200W@8Ω
SR4726X	600 to 1,200W@8Ω	150 to 300W@16Ω	600 to 1,200W@8Ω
SR4731X	1,200 to 2,400W@4Ω	150 to 300W@16Ω	1,200 to 2,400W@4Ω
SR4732X	1,200 to 2,400W@4Ω	150 to 300W@16Ω	1,200 to 2,400W@4Ω
SR4733X	1,200 to 2,400W@4Ω	150 to 300W@16Ω	1,200 to 2,400W@4Ω
SR4735X	600 to 1,200W@8Ω	100 to 200W@8Ω	600 to 1,200W@8Ω

1. Full-range / Parallel: Is the amplifier power required to optimally drive this speaker system when used in full-range (passive) mode. In the case of dual-driver subwoofer models, this is the power required to drive both transducers at the same time.
2. HF: Is the amplifier power required to optimally drive the high-frequency section of this speaker system when used in bi-amp mode.
3. LF: Is the amplifier power required to optimally drive the low-frequency section of this speaker system when used in bi-amp mode.
4. Discrete: Is the amplifier power required to optimally drive an individual transducer in a dual transducer subwoofer.
5. ±1 or ±2 Pass-Thru: This allows for the convenience of a single conductor cable from the amplifier rack to the speakers stack, this configuration supplies separate amplifier power to the subwoofer (ie ±2) and to the mid-high speaker (ie 1 Pass-Thru).

CABLE AND CONNECTIONS

Each connector panel incorporates two Neutrik® Speakon® connectors. The second connector facilitates the ability to "loop through" to other SR-X speakers in the system. The diagrams below detail the cable-side connections.

Passive Systems & Subs (Parallel Mode)

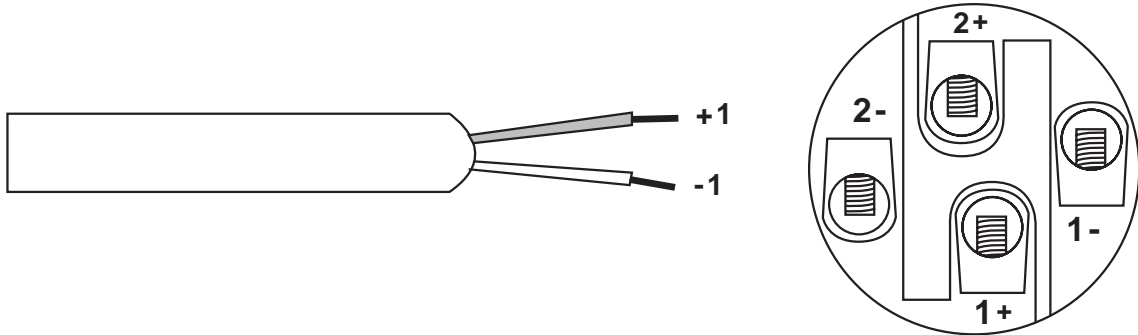

Bi-Amp Systems & Subs (Discrete Mode)

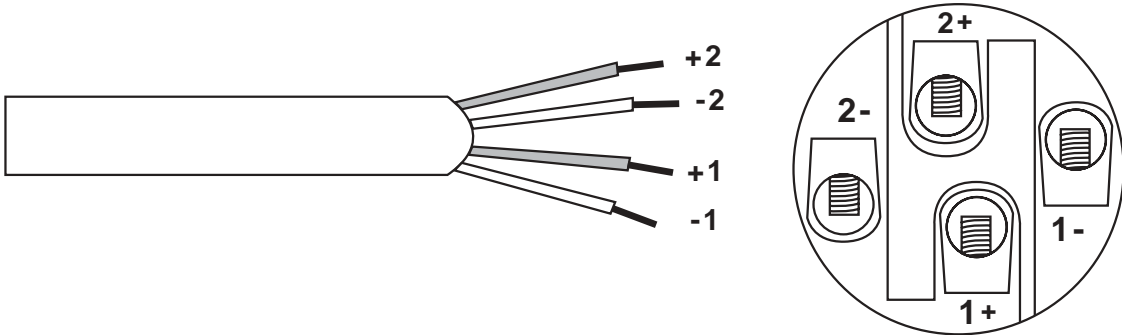

Wire Gauges

Selection of the appropriate wire gauge is important to system operation. A cable that is too light will result in amplifier power being wasted due to the series resistance of the cable and in loss of low-frequency performance due to degraded damping factor.

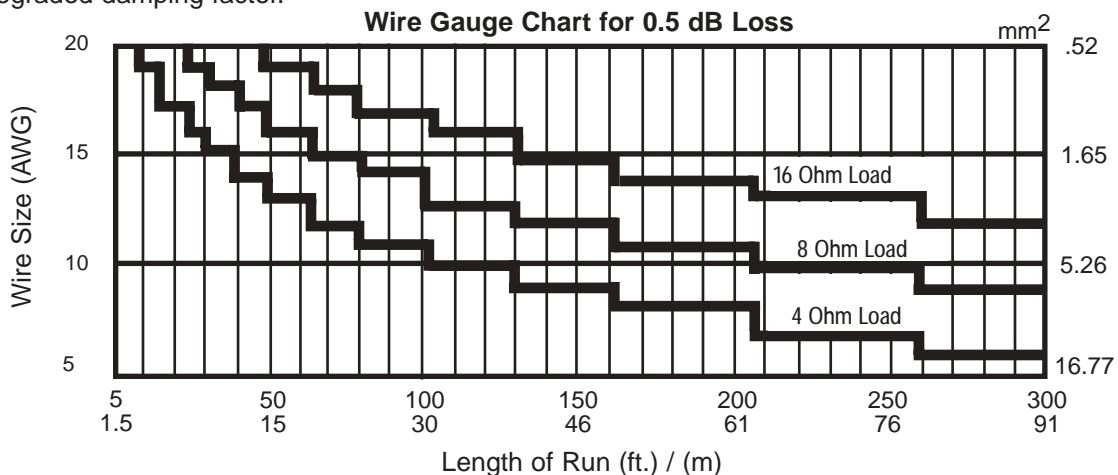

INPUT PANEL

Internal Network Mode Selector

All SR-X models are fitted with the internal network mode selector.

The ability to select the mode of operation provides the sound system user flexibility in the system configuration, and also permits the system to be upgraded at a later date. By simply removing the input panel and changing the position of a heavy duty connector, the system can be configured as either a bi-amp or a passive system. After replacing the input panel, the network position is indicated on the connector plate panel. This provides a truly tamper resistant solution to avoid the horrors of a mis-configuration.

In passive operation, a system can be operated with a minimum of only one amplifier and no additional system controllers. In bi-amp operation, the system can be operated for maximum transducer performance and will require the use of additional amplifiers-and an electronic crossover (see "Crossovers and Controllers"). For Sub systems with more than one transducer, the same ability to select the mode of operation is provided - but instead of bi-amp/passive selection, the input can be configured for either parallel woofers (4 ohm) or individual transducer access (2 x 8 ohm). This can be useful for assuring maximum power transfer from the amplifier to the transducers.

Please Note: There are no passive network components in the circuit when the Bi-amp mode is selected. (Except: SR4732X and SR4735X which retain a crossover section between midrange and HF.)

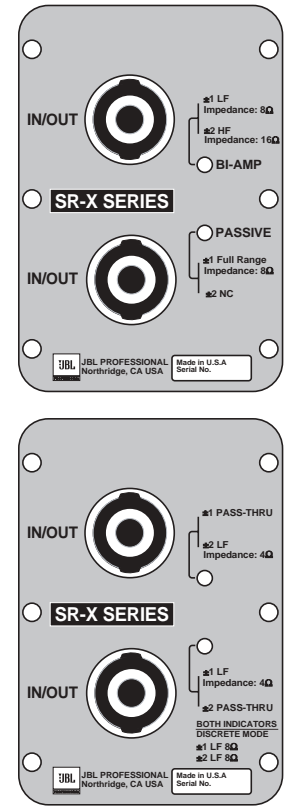

Changing the Input Mode Connector

1. Remove 6 connector plate retaining screws and remove the plate.
2. Turn plate over and locate the male connector.
3. Pull out connector and firmly place in socket of desired system mode - you should be able to see the yellow indicator in the desired mode window.
4. Replace plate and secure with 6 screws.

Please Note: For SR4715X - SR4719X, the connector is split to permit discrete mode operation.

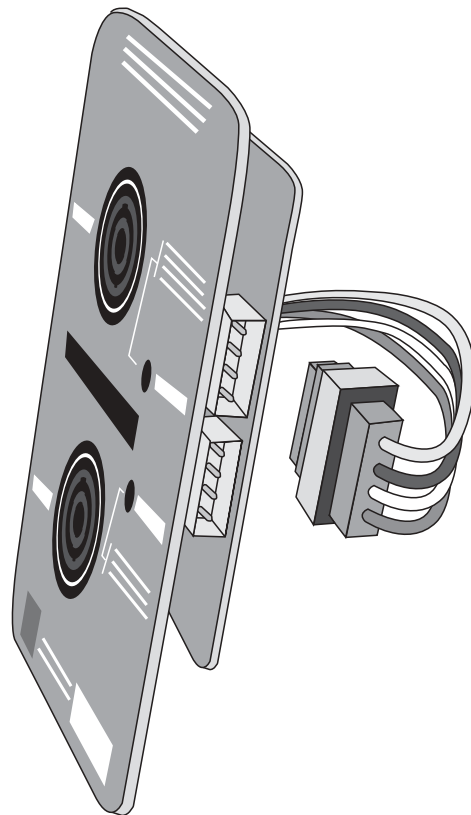

INPUT CONFIGURATIONS

This section describes the different configurations of Input Connector Panel mode selections. The wiring connections from the Input Panel to the transducers change when the mode selector is moved. Please Note: Each line in the diagrams below represents a pair of wires. (E.g. both +1 and -1 connecting wires.)

Subwoofers

SR4718X Pin 1 Hot (as shipped)

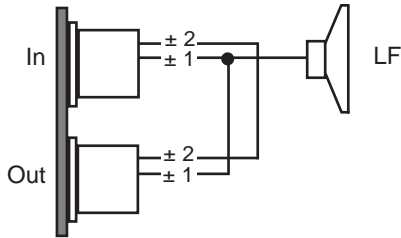

SR4718X Pin 2 Hot

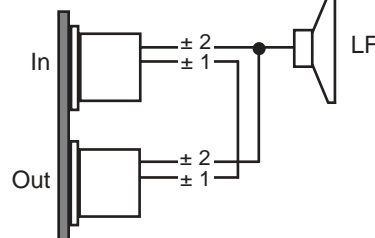

SR4715X/19X Discrete Mode (yellow indicator visible in both windows)

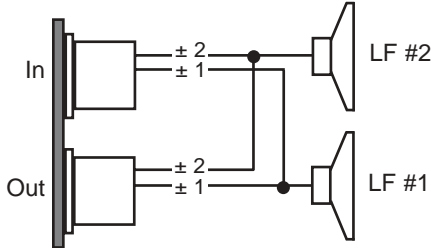

SR4715X/19X Pin 1 Hot (as shipped)

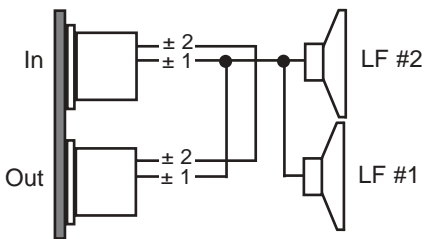

SR4715X/19X Pin 2 Hot

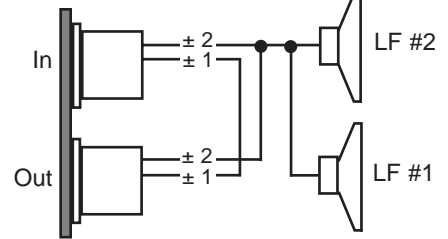

Two-Way Systems

Passive Mode

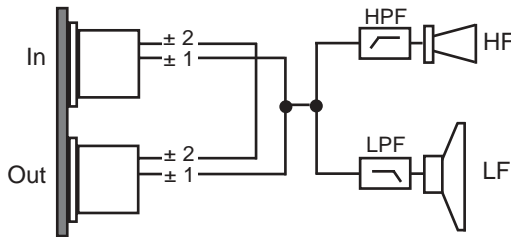

Bi-Amp Mode

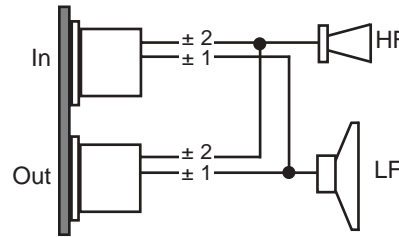

Three-Way Systems

Passive Mode

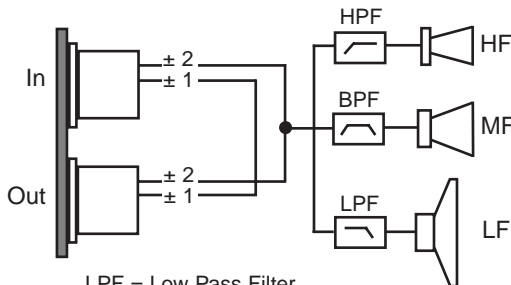

Bi-Amp Mode

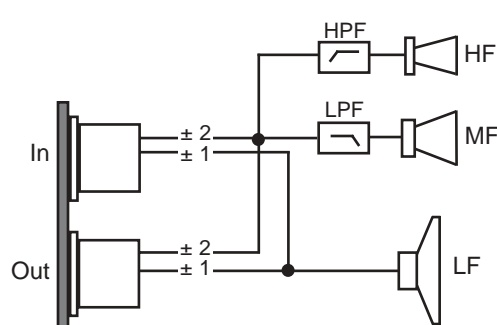

LPF = Low Pass Filter
BPF = Band Pass Filter
HPF = High Pass Filter

CROSSOVERS AND CONTROLLERS

SR-X series loudspeakers may be operated in bi-amplified mode. In this mode, all crossover components are bypassed (except in the case of the three-way SR4732X and SR4735X) and the voice-coils of the drivers are connected directly to the power amplifier outputs. When operated in this manner, an external, electronic crossover is required. Such crossovers may be cards or modules that can be installed in the power amplifiers or may be separate processors.

SR-X series speakers include CD (constant directivity) horn designs. A characteristic of this type of horn is that it requires a power response correction consisting of a 6 dB per octave rise beginning at approximately 4 kHz. This power response correction is built into the passive networks of SR-X series speakers. When used in bi-amp mode, the power response correction must be provided by the electronic crossover. Most analog crossovers will include a "CD Horn EQ" function.

Digital System Controllers

Digital signal processing technology has made it possible to build sophisticated loudspeaker system controllers that incorporate into a single unit, the ability to control crossover frequencies, slopes, and filter topology. In addition, these units may include graphic and parametric equalization, time / phase alignment, and compression / limiting. Some of these digital system controllers include factory-programmed presets for SR-X series loudspeakers. As this manual goes to press, these controllers include the JBL DSC260, and the dbx® DriveRack™ and DriveRack™ PA products.

If you are using a digital system controller that does not include pre-programmed presets for SR-X series loudspeakers, it may be useful to review the JBL DSC260 settings as a starting point for programming your controller. A PDF download detailing these settings may be found at www.jblpro.com/pages/tunings/srx_dsc260.pdf. Note that various processors will respond to these settings in different ways, so you will probably need to refine your settings by ear or with the help of acoustical measurement equipment.

As with any software driven device, it is always good practice to check with the manufacturer of your digital system controller for updates. JBL will also attempt to post notifications of any new developments at www.jblpro.com

JBL DSC260 (front / back)

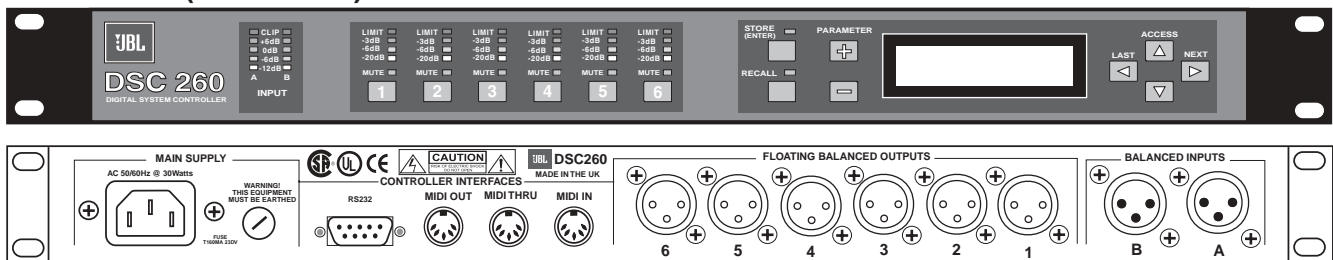

dbx® DriveRack™ PA (front / back)

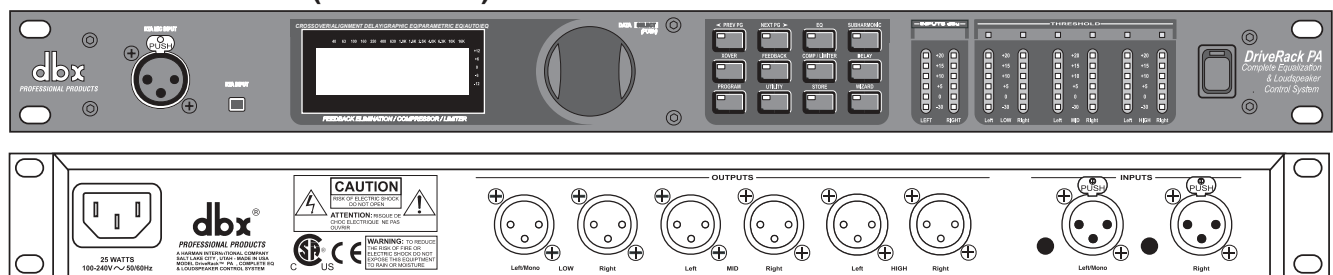

SYSTEM CONFIGURATIONS

There are many different possible configurations of systems within the JBL SR-X Series. This section shows a selection of key system configurations that will provide a basis for setting up any system, it includes: dbx® DriveRack™ PA controllers, Crown® amplifiers and wiring connections. It is very important that you are familiar with the previous sections of this Users Guide and also the dbx® DriveRack™ PA and Crown® amplifiers. Note: Each line in the diagrams below represents a pair of wires. (E.g. both +1 and -1 connecting wire.)

Full-Range Two-Way



Bi-Amplified Two-Way

See "Crossovers and Controllers" for important information.

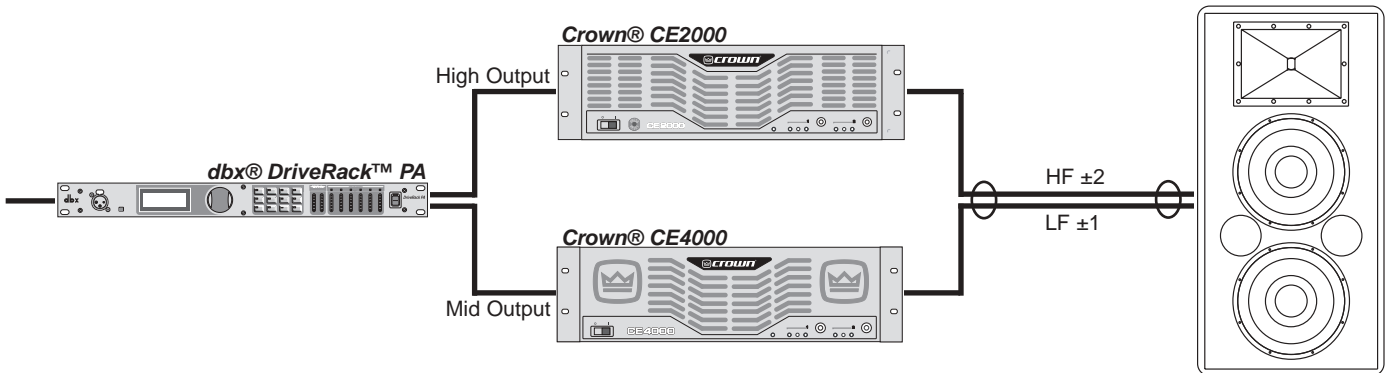

Full-Range Two-Way w/ Sub (Parallel Mode)

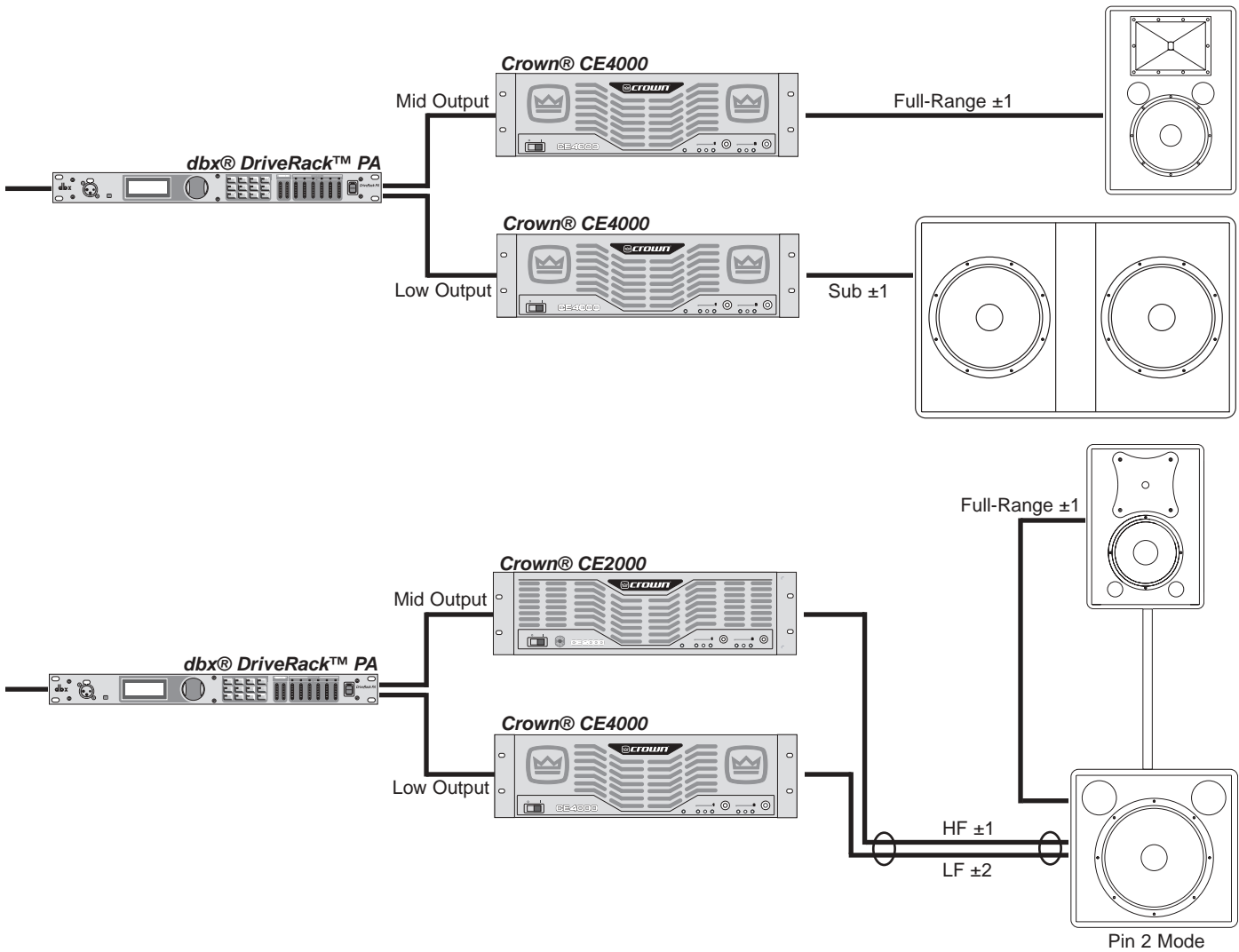

Full-range Two-way with Sub (using a single 4 conductor amp - speaker cable)

Bi-Amp Two-Way w/ Sub (Discrete Mode)

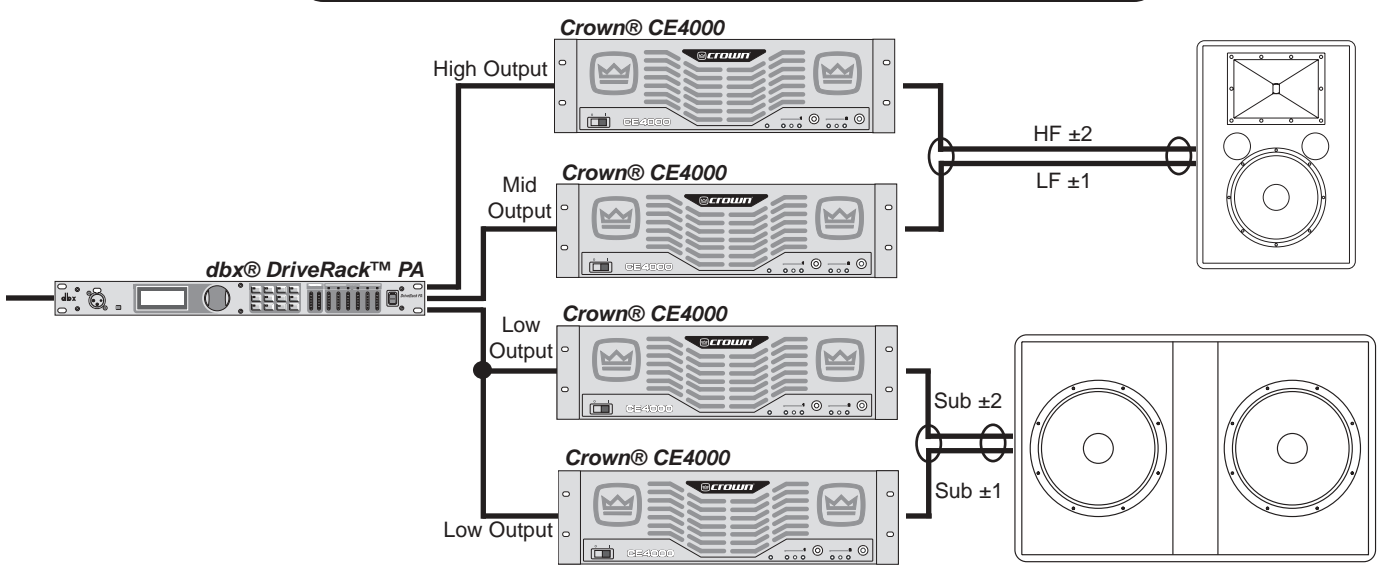

SR-X/F FLYING VERSIONS

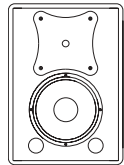

SR4722X/F

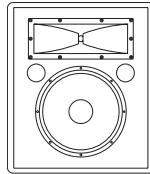

SR4725X/F

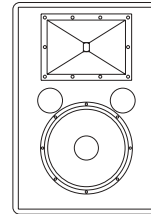

SR4726X/F

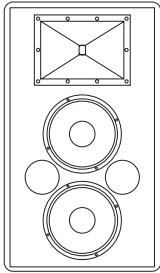

SR4731X/F

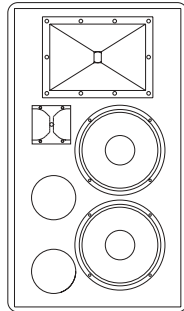

SR4732X/F

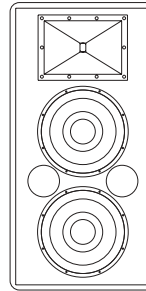

SR4733X/F

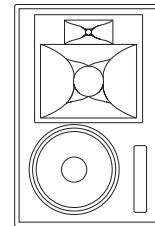

SR4735X/F

Prior to suspending the system, an expert, trained and experienced in flying speaker systems should inspect all components for cracks, deformations, corrosion, missing parts or damaged parts that could reduce strength and integrity of the system. For further information on precautions and rigging techniques, see JBL Technical Note Volume 1, Number 14. This document is available in the Technical Reference section of www.jblpro.com

The rigging track used on SR-X/F models can accommodate both 10 mm forged shoulder eyebolts and detachable track fittings. When using 10 mm forged shoulder eyebolts with SR-X/F, always use a 10 mm washer between the track and the eyebolt/ Failure to do so can result in damage to the track and unsafe suspension of the speaker system. The the event that the track is damaged, the speaker should not be suspended until the damaged part is replaced. A kit containing 10 mm forged eyebolts and washers is available from JBL Professional Parts (PN: 229-00017-00).

When used with an appropriate eyebolt and washer (see above) the SR-X/F suspension system has a working load limit (WLL) of 400 lbs. (181 kg.) per point with a 7:1 design factor. When used with an appropriate track fitting, the SR-X/F suspension system has a working load limit (WLL) of 500 lbs. (227 kg.) per point with a 7:1 design factor.

Suspension or flying speaker systems requires training and expertise. Improper rigging of a flying speaker may result in injury, death, equipment damage, and legal liability. This User Guide is intended to provide a skilled system rigger with resources needed to get the most from the SR-X/F speaker system. This User Guide will not provide the novice with the skills and training needed to safely fly a speaker system. If you lack the skills, training, and proper ancillary equipment to fly a speaker system do not attempt to do so. Obtain the services of a qualified rigger or get the proper training yourself.

The SR-X/F models are equipped with ATM FLY-WARE® rigging hardware. Only hardware rated for overhead suspension and certified in accordance with appropriate safety standards should be used to fly speaker systems. A source for such hardware and assistance in selecting appropriate hardware is:



ATM FLY-WARE
 (888) RIG-MORE / (310) 834-5914
 2100 South Wilmington Avenue
 Carson, CA 90810
www.atmflyware.com

In Europe:
 (44) 0171-482-3300
 102 Grafton Road
 London NW5 4BA UK
www.atmflyware.com

Example

Each primary "load bearing" suspension point shall be rated for the entire load.

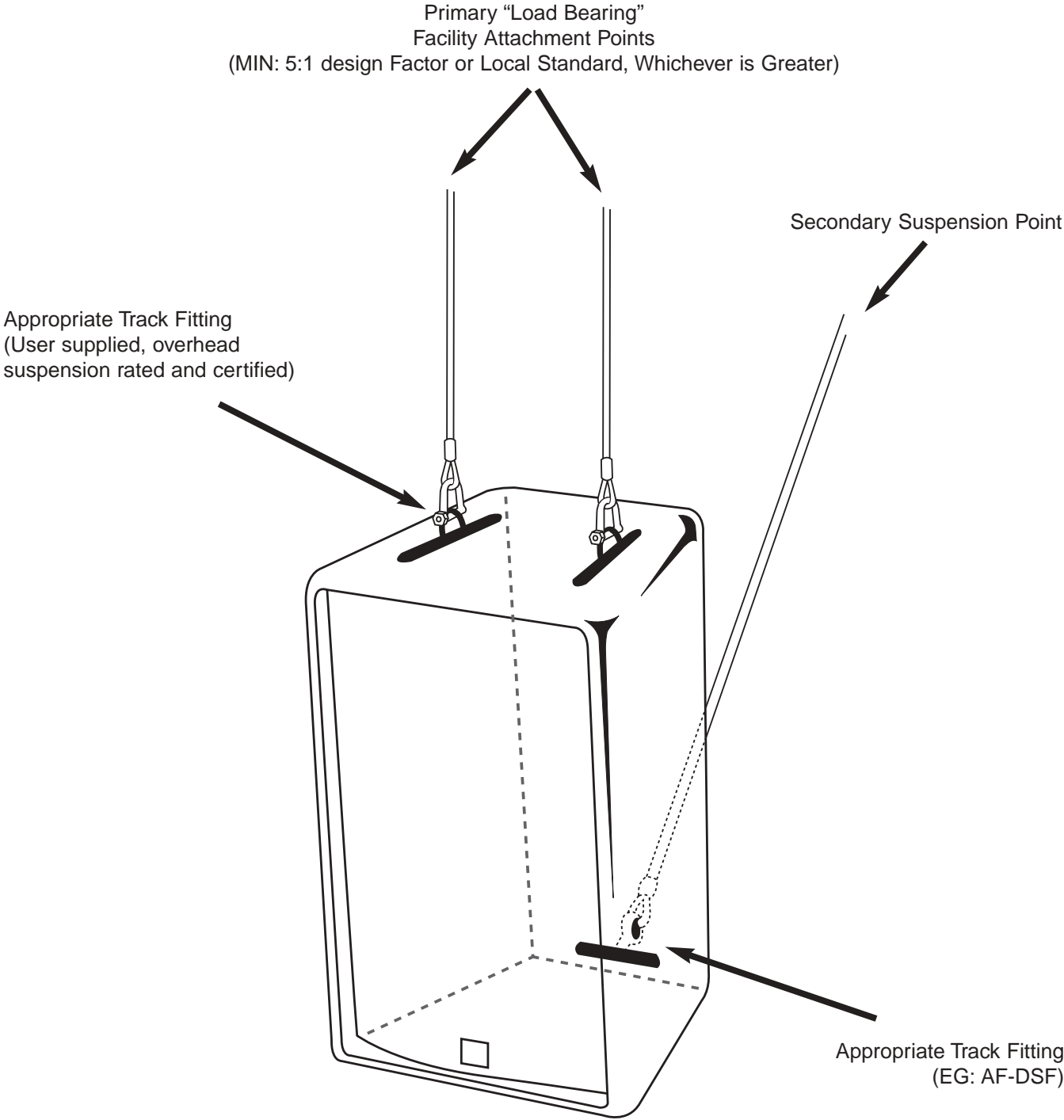

Working load limits: No more than four (4) high (vertical)
The four (4) high vertical specification represents a static ratio of 7:1

JBL WARRANTY AND CONTACTS

Who Is Protected by This Warranty?

Your JBL Warranty protects the original owner and all subsequent owners so long as: A.) Your JBL product has been purchased in the Continental United States, Hawaii or Alaska. (This Warranty does not apply to JBL products purchased elsewhere except for purchases by military outlets. Other purchasers should contact the local JBL distributor for warranty information.); and B.) The original dated bill of sale is presented whenever warranty service is required. The JBL Limited Warranty on professional loudspeaker products (except for enclosures) remains in effect for five years from the date of the first consumer purchase. JBL amplifiers are warranted for three years from the date of original purchase. Enclosures and all other JBL products are warranted for two years from the date of original purchase.

What does the JBL Warranty cover?

Except as specified below, your JBL Warranty covers all defects in material and workmanship. The following are not covered: Damage caused by accident, misuse, abuse, product modification or neglect; damage occurring during shipment; damage resulting from failure to follow instructions contained in your Instruction Manual; damage resulting from the performance of repairs by someone not authorized by JBL; claims based upon any misrepresentations by the seller; any JBL product on which the serial number has been defaced, modified or removed.

Who Pays for What?

JBL will pay all labor and material expenses for all repairs covered by this warranty. Please be sure to save the original shipping cartons because a charge will be made if replacement cartons are requested. Payment of shipping charges is discussed in the next section of this warranty.

How to Obtain Warranty Performance?

If your JBL product ever needs service, write or telephone us at JBL Incorporated (Attn: Customer Service Department), 8500 Balboa Boulevard, PO. Box 2200, Northridge, California 91329 (818/893-8411). We may direct you to an authorized JBL Service Agency or ask you to send your unit to the factory for repair. Either way, you'll need to present the original bill of sale to establish the date of purchase. Please do not ship your JBL product to the factory without prior authorization. If transportation of your JBL product presents any unusual difficulties, please advise us and we may make special arrangements with you. Otherwise, you are responsible for transporting your product for repair or arranging for its transportation and for payment of any initial shipping charges. However, we will pay the return shipping charges if repairs are covered by the warranty.

Contact Information

Mailing Address:

JBL Professional
8500 Balboa Blvd.
Northridge, CA 91329

Shipping Address:

JBL Professional
8370 Balboa Blvd., Dock D
Northridge, CA 91329

Customer Service:

Monday through Friday
8:00am - 5:00pm
Pacific Coast Time In the U.S.A.
(800) 8JBLPRO (800.852.5776)
www.jblproservice.com

On the World Wide Web:

www.jblpro.com

Outside the USA:

Contact the JBL Professional Distributor in your area. A complete list of JBL Professional international distributors is provided at our U.S.A. website - www.jblpro.com

Product Registration:

Register your product online at www.jblpro.com/registration



H A Harman International Company

Free Manuals Download Website

<http://myh66.com>

<http://usermanuals.us>

<http://www.somanuals.com>

<http://www.4manuals.cc>

<http://www.manual-lib.com>

<http://www.404manual.com>

<http://www.luxmanual.com>

<http://aubethermostatmanual.com>

Golf course search by state

<http://golfingnear.com>

Email search by domain

<http://emailbydomain.com>

Auto manuals search

<http://auto.somanuals.com>

TV manuals search

<http://tv.somanuals.com>