

**RM3 SERIES
BACKREFLECTION METER****User's Manual**

Contents

Safety Information, Instructions, and Symbols	4
Safety Information	4
Classification	4
Disconnecting from Line Power	4
Line Power Requirements	4
Fuse Type.....	4
Laser Specifications	4
Safety Instructions.....	6
Before Initializing and Operating the Unit	6
Operating the Unit	6
Safety Symbols	8
Compliance	9
CE Compliance.....	9
FDA-CDRH Compliance	9
CSA / IEC Compliance.....	9
General Information and Specifications	11
General Information	11
Backreflection Measurements.....	12
Loss and Power Measurements	12
Output Port	13
Internal Light Sources	13
Hybrid Jumpers.....	13
Coherence Length	13
Electrical Requirements	13
Key Features	13
Applications	14
Standard Accessories.....	14
Optional Accessories	14
Specifications.....	15
Getting Started	18
Before Initializing and Operating the Unit.....	18
Initial Inspection.....	18
Operating Environment	19
Altitude.....	19
Temperature	19
Humidity.....	19
Voltage	19
Storing and Shipping.....	19
Claims and Repackaging.....	19
Returning Shipments to JDS Uniphase	19
Cleaning Connectors.....	20
Powering Up the Meter.....	21
Operating and Maintenance Instructions	22

Front Panel.....	22
Rear Panel	23
Termination Techniques.....	23
Termination Techniques for Single-mode Fiber (except 980 nm)	23
Termination Techniques for Single-mode (980 nm) and Multimode Fiber	24
Backreflection Measurements.....	25
Setting Up the Meter for Backreflection Measurements.....	25
Measuring Backreflection	26
Backreflection Accuracy and Range.....	27
Loss and Power Measurements.....	27
Setting Up the Meter for Loss and Power Measurements	27
Measuring Power.....	28
Measuring Relative Power (Insertion Loss).....	29
Power Accuracy.....	30
Data Logging Using the Foot Pedal	30
Messages and Symbols	30
Calibrating the Meter.....	31
Backreflection Calibration Adjustment	32
Power Calibration Adjustment.....	32
Maintaining the Meter.....	33
Cleaning the Unit.....	33
Cleaning the Connector Ends.....	33
Recharging the Battery.....	34
Replacement of Internal Fuses.....	34
Troubleshooting.....	34
Programming Guide.....	37
RS232 Serial Interface	37
RS232 Pin Assignment.....	37
RS232 Interface Specifications.....	37
RS232-GPIB Converter.....	39
Left Dip Switch.....	39
Right Dip Switch	39
Programming Examples	40
RS232 Interface Program Example	40
Customized Features and Test Data.....	41

***For sales and service information,
contact JDS Uniphase or your local representative.***

**JDS Uniphase Corporation
570 West Hunt Club Road
Nepean, Ontario, Canada
K2G 5W8
Phone: 613 727-1303
Fax: 613 727-8284
E-mail: instruments@jdsuniphase.com**

Website: <http://www.jdsuniphase.com>

Safety Information, Instructions, and Symbols

Safety Information

Classification

The RM Series Backreflection Meter consists of an exposed metal chassis that is connected directly to earth via a power cord and, therefore, is classified as a Class 1 instrument.

Disconnecting from Line Power

Some of the circuits are powered whenever the unit is connected to the AC power source (line power). To ensure that the unit is not connected to the line power, disconnect the power cord from either the power inlet on the unit's rear panel or from the AC line-power source (receptacle). The power cord must always be accessible from one of these points. If the unit is installed in a cabinet, the operator must be able to disconnect the unit from the line power by the system's line-power switch.

Line Power Requirements

The RM meter operates from any single-phase AC power source that supplies between 100 and 240 V at a frequency range of 50 to 60 Hz. The maximum power consumption of the RM meter is 25 VA. The unit can also be operated using its internal 6V DC rechargeable battery.

Fuse Type

The fuse type used by the unit is (5 x 20) mm, 1 A/250 V (fast).

Laser Specifications

Laser specifications are provided in Table 1.

Table 1: Specifications

Parameter	Single-mode (SM)	Multimode (MM)	
Wavelength	980*, 1310, 1480, 1550, 1625, or 1650 ± 10 nm	850, or 1310 ± 20 nm	
Class	1	1	
Fiber Type	9/125 µm SM(*5/125 µm SM)	50/125 µm MM	62.5/125 µm MM
Maximum Accessible Emission Level	-15 dBm	-23 dBm	-25 dBm
Maximum Output Power	-4 dBm	-4 dBm	-4 dBm
Numerical Aperture	0.13 (*0.14)	0.20	0.28
Effective Numerical Aperture	0.20 (*0.21)	0.27	0.34

Under the laser classification of the US Food and Drug Administration (FDA) Center for Devices and Radiological Health (CDRH), the laser contained in the unit is a Class 1 laser.



Safety Instructions

The following safety instructions must be observed whenever the unit is operated, serviced, or repaired. Failure to comply with any of these instructions or with any precaution or warning contained in the user's manual is in direct violation of the standards of design, manufacture, and intended use of the unit. JDS Uniphase assumes no liability for the customer's failure to comply with any of these safety requirements.

Before Initializing and Operating the Unit

- Inspect the unit for any signs of damage, and read the user's manual thoroughly.
- Install the unit as specified in the **Getting Started** section.
- Ensure that the unit and any devices or cords connected to it are properly grounded.

Operating the Unit





	<p>Warning</p> <p>To avoid the risk of injury or death, always observe the following precautions before initializing the unit:</p> <ul style="list-style-type: none">• To prevent hazardous radiation exposure, use only the controls or adjustments and perform only procedures specified for the laser source.• If using a voltage-reducing autotransformer to power the unit, ensure that the common terminal connects to the earthed pole of the power source.• Use only the type of power cord supplied with the unit.• Connect the power cord only to a power outlet equipped with a protective earth contact. Never connect to an extension cord that is not equipped with this feature.• Willfully interrupting the protective earth connection is prohibited.• Never look into the end of an optical cable connected to an optical output device that is operating. Laser radiation is invisible, and direct exposure can severely injure the human eye. For more information, see the user's manual of the laser source in use.• Do not use the unit outdoors.• To prevent potential fire or shock hazard, do not expose the unit to any source of excessive moisture.• Do not operate the unit when its covers or panels have been removed.• Do not interrupt the protective earth grounding. Any such action can lead to a potential shock hazard that can result in serious personal injury.• Do not operate the unit if an interruption to the protective grounding is suspected. In this case, ensure that the unit remains inoperative.• Use only the type of fuse specified by JDSU as appropriate for this unit. Do
---	---

	<p>not use repaired fuses, and avoid any situations that can short-circuit the fuse.</p> <ul style="list-style-type: none">• Unless absolutely necessary, do not attempt to adjust or perform any maintenance or repair procedure when the unit is opened and connected to a power source.• Repairs are to be carried out only by a JDSU qualified technician.• Do not attempt any adjustment, maintenance, or repair procedure to the unit's internal mechanism if immediate first aid is not accessible.• Disconnect the power cord from the unit before adding or removing any components.• Operating the unit in the presence of flammable gases or fumes is extremely hazardous.• Do not perform any operating or maintenance procedure that is not described in the user's manual.• Some of the unit's capacitors can be charged even when the unit is not connected to the power source.• If the equipment is used in a manner not specified by the manufacturer, the protection provided by the equipment may be impaired.
--	---

Safety Symbols

The following symbols and messages can be marked on the unit (Table 2). Observe all safety instructions that are associated with a symbol.

Table 2: Safety Symbols

Symbol	Description
	Laser safety. See the user's manual for instructions on handling and operating the unit safely.
	See the user's manual for instructions on handling and operating the unit safely.
	Electrostatic discharge (ESD). See the user's manual for instructions on handling and operating the unit safely.
	Frame or chassis terminal for electrical grounding within the unit.
	Protective conductor terminal for electrical grounding to the earth.
<p>WARNING</p>	<p>The procedure can result in serious injury or loss of life if not carried out in proper compliance with all safety instructions. Ensure that all conditions necessary for safe handling and operation are met before proceeding.</p>
<p>CAUTION</p>	<p>The procedure can result in serious damage to or destruction of the unit if not carried out in compliance with all instructions for proper use. Ensure that all conditions necessary for safe handling and operation are met before proceeding.</p>

Compliance

CE Compliance

The unit has been designed and tested to comply with directive 73/23/EEC and its subsequent amendments by the European Community (EC or CE). The directive relates to electrical equipment designed for use within certain voltage limits. It ensures that electrical equipment is constructed with good engineering practice in safety matters.

The unit has been designed and tested to comply with directive 89/336/EEC and its subsequent amendments. The directive relates to electromagnetic compatibility. It demands that electromagnetic disturbance does not exceed a prescribed level; that the equipment be immune to a prescribed level of ambient level of interference; that the equipment be protected against electrostatic discharges; and that the equipment be immune to all electrical shock wave disturbances. As of 1997, measures have been added to test for fire hazard, electric shock hazard, and also external exposure to other forms of energy.

The requirements specified by directive 89/336/EEC are as follows. CE compliance requires that the manufacturer or its authorized representative established within the Community affix the CE conformity mark to the apparatus or else to the packaging, instructions for use, or guarantee certificate. The CE conformity mark shall consist of the letters CE as specified and the figures of the year in which the mark was affixed. This mark should, where appropriate, be accompanied by the distinctive letters used by the notified body issuing the CE type-examination certificate. Where the apparatus is the subject of other Directives providing for the CE conformity mark, the affixing of the CE mark shall also indicate conformity with the relevant requirements of those other Directives.

FDA-CDRH Compliance

Under the US Food and Drug Administration (FDA) Center for Devices and Radiological Health (CDRH), the unit complies with the Code of Federal Regulations (CFR), Title 21, Subchapter J, which pertains to laser safety and labeling. See <http://www.fda.gov/cdrh/radhlth/cfr/21cfr1000-1050.pdf> for more information.

CSA / IEC Compliance

The unit complies with certain standards of the Canadian Standards Association (CSA) and the International Electrotechnical Commission (IEC).

The unit is in Installation Category (Overvoltage Category) II under IEC 664. IEC 664 relates to impulse voltage levels and insulation coordination. The particular category is defined as: local level, appliances, portable equipment, etc, with smaller transient overvoltages than Installation Category (Overvoltage Category) III.

The unit is in the Pollution Degree 2 category under IEC 1010-1 and CAN/CSA-C22.2 No. 1010.1. The IEC standard on Safety Requirements for Electrical Equipment for Measurement, Control, and Laboratory Use relates to insulation coordination. The CSA standard is on Safety Requirements for Electrical Equipment for Measurement Control, and Laboratory Use, Part I: General Requirements. The Pollution Degree 2 category is defined as follows: "Normally only

non-conductive pollution occurs. Occasionally, however, a temporary conductivity caused by condensation must be expected.”

General Information and Specifications

General Information

This user's manual for the RM3 Series Backreflection Meter contains complete operating instructions. The RM meter can be ordered as a single-mode or multimode model. Software is bundled with the meter; for information on using the software, see the *Multiple Connector Test System Software User's Manual* (document SD000318). The inspection report and a description of any customer-requested information are found in **Customized Features and Test Data** section.

The RM meter (Figure 1) is a portable, direct-display instrument that measures backreflection, loss, and power of single-mode and multimode fiberoptic connectors, components, and systems. The RM meter is supplied with one or two internal laser sources for operation at 850, 980, 1310, 1480, 1550, 1625, or 1650 nm (not all combinations are available).



Figure 1: RM Meter

An important feature of the RM meter is the FC/APC ultra-low backreflection connector at its output port (SC/APC connector also offered). By switching hybrid jumpers connected to the FC/APC connector, the user can select the connector type required for a measurement quickly and easily, without limiting the backreflection range of the meter. The RM meter is supplied with a hybrid measurement jumper to be used exclusively for measurements and a hybrid calibrated jumper to be used exclusively for calibrations.

The RM meter can be operated using an internal 6 V DC rechargeable battery.

The RM meter includes a convenient foot pedal, enabling the user to trigger the meter to send measurement data to a computer or printer.

The RM meter operates over the RS232 serial interface. Wherever the IEEE 488 GPIB parallel interface is mentioned, it is achieved via a RS232-to-GPIB converter that can be purchased as an accessory.

Backreflection Measurements

Reflections in optical systems can come from a number of sources. Primary sources include the fiber (Rayleigh backscatter) and Fresnel reflections that occur at the planar junction of two materials having different refractive indices, for example, connector and fiber endfaces, splices, bulk optic interfaces, and detector surfaces.

Typically only Fresnel reflections are significant because transmitters are relatively insensitive to distributed reflections such as Rayleigh backscatter. Backreflection caused by Rayleigh backscatter varies with the length and type of fiber, and is only significant when measuring components with backreflections below -40 dB or with very long pigtails (multimode). However, Rayleigh backscatter can be a large contributor to backreflection in installed systems or when using long fiber.

The internal switch and coupler of the RM meter enable the meter to measure the internal light source signal (P_{in}), the signal offset with no light (P_{dark}), and the total signal level from internal and external backreflections (P_{br}).

The RM meter first calculates the total backreflection from internal and external sources (BR_{tot}), using the following equation, where CAL is the factory-set calibration factor of the meter:

$$BR_{tot} = 10 \log (P_{br} - P_{dark}) / (P_{in} - P_{dark}) - CAL \quad [dB]$$

The backreflection from external sources (BR) is then calculated using the following equation, where BR_0 is the stored value of the total backreflection up to the device under test (DUT), and User CAL is the user-set calibration factor:

$$BR = 10 \log (10^{BR_{tot}/10} - 10^{BR_0/10}) + User CAL \quad [dB]$$

The RM meter then displays the value of BR.

The BR measurement takes approximately one second to complete. Before this is done, the P_{in} and P_{dark} measurements are completed in approximately four seconds, during which time the backreflection display is locked and the light from the output port is blocked. The values are then updated every minute.

Loss and Power Measurements

The RM meter is equipped with a front-panel InGaAs detector for relative power (loss) and absolute power measurements. (Absolute power is referred to as power in this manual; relative power is always referred to as relative power.) Because the meter is capable of storing the dark signal from the detector, high-accuracy power measurements as low as -80 dBm for the single mode model (and -60 dBm for the multimode model) can be obtained.

When making power measurements, the RM meter first measures two signals: the total signal level (I_{tot}) and the dark signal from the detector (I_D). The RM meter then calculates the power measurement using the following equation, where CAL is the factory-set calibration factor and User CAL is the user-set calibration factor:

$$P = 10 \log (I_{tot} - I_D) + CAL + User CAL \quad [dB]$$

Output Port

The output port of the RM meter is equipped with an ultra-low backreflection APC connector. To prevent damage to the output port connector, a measurement jumper must be used for all measurements, even for measuring a component with an APC connector.

Internal Light Sources

The RM meter can be equipped with two internal laser sources. These are thermoelectrically cooled for added stability and are modulated at 10 kHz. Fast changes in ambient temperature can cause a source to become unstable. If this occurs, the meter automatically switches to a measuring mode in which P_{in} and P_{dark} are measured more frequently than every minute and the message "Source Unstable" is displayed. The light source power is monitored, and the meter returns to the standard measurement mode when the source has stabilized.

Hybrid Jumpers

The RM meter is supplied with a hybrid measurement jumper and a hybrid calibrated jumper. The measurement jumper has an APC connector at the input end. The other end on the standard measurement jumper is PC, but by changing measurement jumpers this end is user-selected, to be compatible with the input connector of the DUT. The calibrated jumper has an APC connector at the input end and a PC connector at the output end.

Use the measurement jumper for measurement purposes only; use the calibrated jumper for calibration purposes only. The calibrated jumper has a label attached to it identifying it as the calibrated jumper.

Coherence Length

Reflected light from multiple reflections can change the backreflection measured by the RM meter. This variation typically shows up as noise or drift in the signal. The internal light source is designed to have low coherence length (typically less than 10 cm). Thus, interference effects are typically seen only between very closely spaced components such as non-contacting connectors.

Electrical Requirements

The RM meter is supplied with a rechargeable battery. When fully charged, the battery provides up to eight hours of operation at room temperature. For laboratory use, use the RM meter with the power cord. The letter B is shown on the RM meter front panel display when the battery power is low.

Key Features

- Backreflection measurements to -75 dB for single mode model (-40 dB for multi mode model)
- Power measurements to -80 dBm for single mode model (-60 dBm for multi mode model)
- Convenient foot pedal for data logging
- MCTS application software
- Built-in light sources at 850, 980, 1310, 1480, 1550, 1625, or 1650 nm
- Compensation for extraneous backreflection for accurate backreflection measurements

- User-calibration mode
- RS232 serial and IEEE 488 GPIB parallel interface
- Convenient data logging via serial port to a computer or serial printer
- Direct display of measured backreflection, power, or insertion loss

Applications

- Connector backreflection and loss testing
- Component testing
- Installation verification
- Quality assurance (QA) acceptance testing

Standard Accessories

- AC power cord (country specific)
- Laser sources specified when ordered
- FC/PC-FC/APC or SC/PC-SC/APC hybrid measurement jumper
- FC/PC-FC/APC or SC/PC-SC/APC hybrid calibrated jumper
- FC-type (or SC-type) detector adapter
- Detector cap
- Foot pedal
- MCTS software and user's manual
- User's manual
- Carrying case (for field use)
- Certificate of Compliance (NIST Traceability Report available on request)

Optional Accessories

- Variety of detector adapters
- Measurement jumpers with various user-selected connectors
- RS232-to-GPIB converter

Specifications

The following optical specifications describe the warranted characteristics of the unit (Table 3). Supplementary specifications describe the typical non-warranted performance of the unit (Table 4).

Table 3: Optical Specifications

Parameter	Specification	
	Single-mode	Multimode
Operating wavelength	980, 1310, 1480, 1550, 1625, or 1650 \pm 10 nm	850, 1310 nm \pm 20 nm
Fiber Type	9/125 μ m single-mode (5/125 μ m Flexcor* 1060 for the 980 nm)	50/125 μ m or 62.5/125 μ m multimode
Detector type	2 mm diameter InGaAs	3 mm diameter InGaAs
Range backreflection power	0 to -75 dB 0 to -80 dBm	0 to -40 dB ¹ 3 to -60 dBm
Absolute accuracy backreflection power	\pm 1.0 dB ^{2,3} \pm 0.25 dBm typical at -10 dBm ^{5,6}	\pm 1.0 dB ⁴ \pm 0.25 dBm typical at -10 dBm ⁶
Relative accuracy backreflection power	\pm 0.4 dB ³ \pm 0.05 dB (<5 dB loss), \pm 0.15 dB (>5 dB loss) ⁵	\pm 0.7 dB ⁴ \pm 0.15 dB (>5 dB loss) ^{6,7}
Output connector type	Panel-mounted, low-backreflection APC	
Remote interface	RS232 or IEEE 488 (GPIB)	

¹ Reduced backreflection accuracy in the last 10dB of range based on termination effectiveness. Depending on the measurement setup, measurements with lower levels are possible at reduced accuracy.

² User-calibration supported.

³ For a typical application, add \pm 0.4 dB for readings between -60 and -67 dB. Add \pm 0.8 dB for readings between -67 and -72 dB. Add \pm 1.5 dB for readings between -72 and -75 dB.

⁴ Following the user-calibration procedure at the recommended interval. For simple reflections, such as flat-end connectors.

⁵ Add \pm 0.1 dB between -70 and -80 dBm.

⁶ Immediately after performing a dark measurement.

⁷ Add \pm 0.1 dB between 0 to 3 dBm and between -35 and -40 dBm.

* Flexcor is a trademark of Corning[®].

Table 4: Other Specifications

Electrical	
Input voltage	100 to 240 V AC, 50 to 60 Hz
Power consumption	25 VA maximum
Physical	
Display	16-character LCD
Dimensions (W x H x D)	26 x 11 x 26 cm
Weight	4 kg
Environmental	
Operating temperature	0 to 40 °C
Storage temperature	-40 to 70 °C
Humidity	maximum 95% RH from 0 to 40 °C
Equipment positioning	transportable

Getting Started

The RM3 Series Backreflection Meter consists of the meter, an AC power cord, two jumpers, and a foot pedal.

Before Initializing and Operating the Unit

- Inspect the unit for any signs of damage.
- Read the user's manual thoroughly, and become familiar with all safety symbols and instructions to ensure that the unit is operated and maintained safely.
- If the unit is used in a manner not specified by JDS Uniphase, the protection provided by the unit may be impaired.

Initial Inspection

	<p>Warning</p> <p>To avoid electrical shock, do not initialize or operate the unit if it bears any sign of damage to any portion of its exterior surface, such as the outer cover or panels.</p>
---	---

Check that the unit and contents are complete:

1. Inspect the shipping container for any indication of excessive shock to the contents, and inspect the contents to ensure that the shipment is complete.
2. Inspect the unit for structural damage that can have occurred during shipping.
3. Connect the unit to the power source using the power cord provided.
4. Set the power switch to **ON** to initialize the RM meter, and observe the power-up sequence. The model number of the meter is displayed. Internal measurements of P_{in} and P_{dark} are made. The message "Stabilizing" is displayed as the light source stabilizes. The backreflection value (BR) of the front panel connector is measured and displayed.
5. Set the power switch to **OFF** and disconnect the RM meter.
6. Connect the foot pedal to the Log port at the back of the meter if you intend to send data from the meter to a computer or printer.
7. Keep the packaging.

Immediately inform JDS Uniphase and, if necessary, the carrier if the contents of the shipment are incomplete, if the unit or any of its components are damaged or defective, or if the unit does not pass the initial inspection.

Operating Environment

In order for the unit to meet the warranted specifications, the operating environment must meet the following conditions for altitude, temperature, humidity, and voltage.

Altitude

The unit can be operated at an altitude up to 2000m.

Temperature

The unit can be operated in the temperature range of 0 to 40 °C.

Humidity

The unit can be operated in environments with up to 95% humidity (0 to 40 °C). Do not expose it to any environmental conditions or changes to environmental conditions that can cause condensation to form inside the unit.

Voltage

The main supply voltage fluctuations are not exceeding $\pm 10\%$ of the nominal voltage.



Warning

- Do not use the unit outdoors.
- To prevent potential fire or shock hazard, do not expose the unit to any source of excessive moisture.

Storing and Shipping

To maintain optimum operating reliability, do not store the unit in locations where the temperature falls below -40 °C or rises above 70 °C. Avoid any environmental condition that can result in internal condensation. Ensure that these temperature and humidity requirements can also be met whenever the unit is shipped.

Claims and Repackaging

Immediately inform JDS Uniphase and, if necessary, the carrier, if

- The contents of the shipment are incomplete
- The unit or any of its components are damaged or defective
- The unit does not pass the initial inspection

In the event of carrier responsibility, JDS Uniphase will allow for the repair or replacement of the unit while a claim against the carrier is being processed.

Returning Shipments to JDS Uniphase

JDS Uniphase only accepts returns for which an approved Return Material Authorization (RMA) has been issued by JDS Uniphase sales personnel. This number must be obtained prior to shipping any material to JDS Uniphase. The owner's name and address, the model number and full serial number of the unit, the RMA number, the original JDSU sales order number, the

invoice number, and an itemized statement of claimed defects must be included with the return material.

Ship return material in the original shipping container and packing material. If these are not available, packaging guidelines are as follows:

1. Cover the front panel with foam to prevent damage.
2. Wrap the unit in anti-static packaging. Use anti-static connector covers.
3. Pack the unit in a reliable shipping container.
4. Use enough shock-absorbing material (10 to 15 cm) to cushion the unit and prevent it from moving inside the container. Pink poly anti-static foam is the best material.
5. Seal the shipping container securely.
6. Clearly mark FRAGILE on its surface.
7. Always provide the model and serial number of the unit and, if necessary, the RMA number on any accompanying documentation.
8. In order to ship the unit please contact the JDS RMA department at 613-727-1303.

Cleaning Connectors

	<p>Caution</p> <ul style="list-style-type: none">• Connecting damaged or dirty fibers to the unit can damage the connectors on the unit.• Never force an optical connector. Some connectors have a ceramic ferrule that can easily be broken.
---	---

Optical cable ends need to be cleaned before using them with the unit.

The following items are required for cleaning:

- Filtered compressed air or dusting gas (for example, Tech Spray Envi-Ro-Tech Duster 1671 gas, available from <http://www.techspray.com>)
- Lint-free pipe cleaners (for example, from 3M¹) or lint-free swab
- Lint-free towels (for example, 10 x 10 cm or 4 x 4 in HydroSorb III wipers, available from <http://www.focenter.com>)
- Optical grade isopropyl alcohol or optical grade 200° ethanol (do not use rubbing alcohol, which contains 30% water)

To clean the connectors:

¹ 3M is a trademark of 3M.

1. Blow the sleeve with filtered compressed air (Figure 2).

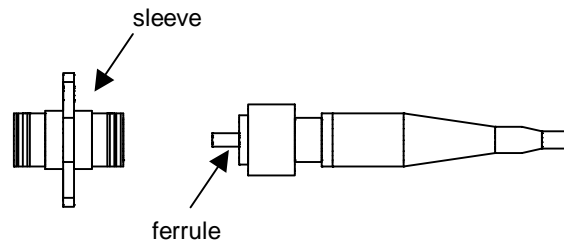

Figure 2: Connector Cleaning (connector type can vary)

2. Apply optical grade isopropyl alcohol or optical grade ethanol (do not use rubbing alcohol) to a small area of a lint-free towel and rub the end of the ferrule over the wet area.
3. Wipe the ferrule on a dry area of the lint-free towel.
4. Using the dusting gas or compressed air, blow the end of the ferrule.
5. Apply the alcohol or ethanol to a lint-free pipe cleaner or swab and wipe off the remaining parts of the connector.
6. With the other end of the pipe cleaner or swab, dry the areas cleaned.
7. Using the dusting gas or compressed air, blow the areas cleaned.

Powering Up the Meter

To power up the meter:

1. Connect the meter to an AC power source using the power cord provided.
2. Set the power switch to **ON** to initialize the RM meter, and observe the power-up sequence: The model number of the meter is displayed. Internal measurements of P_{in} and P_{dark} are made. The message "Stabilizing" is displayed as the light source stabilizes. The backreflection value (BR) of the front panel connector is measured and displayed.

Operating and Maintenance Instructions

Front Panel

The front of the meter (model RM3750) is shown in Figure 3 and described in Table 5. Not all RM3 Series meters are exactly as shown.

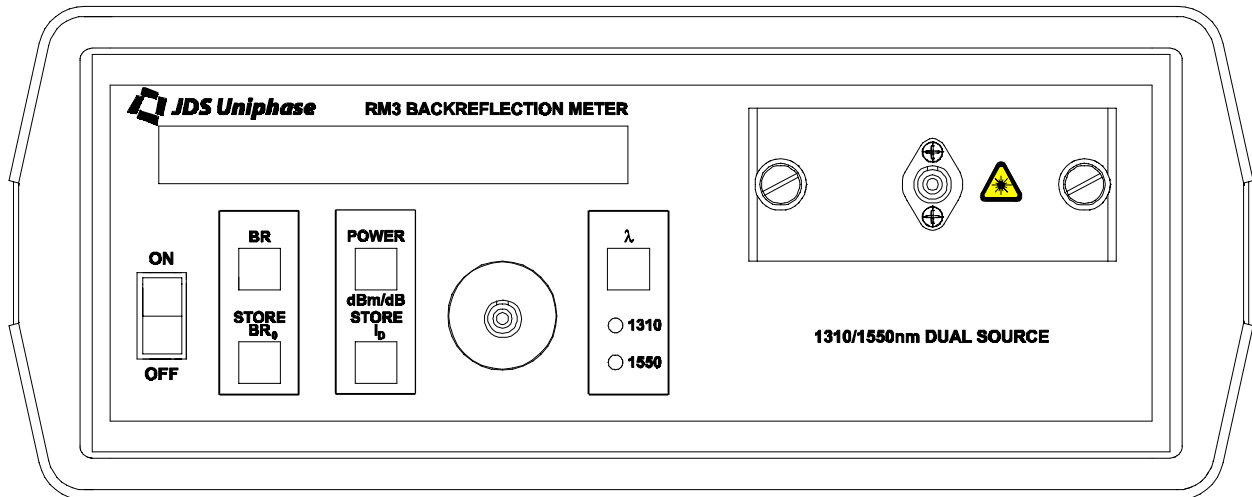

Figure 3: Front of the Meter

Table 5: Front Panel Operating Keys and LEDs

Key/LED	Description
ON / OFF	Power on ON / OFF switch.
BR	Sets the meter to Backreflection measurement mode.
STORE BR ₀	Stores the BR ₀ value used in backreflection measurements and toggles the key lamp on and off.
POWER	Sets the meter to Power and Relative Power measurement modes.
STORE I _D	Stores the I _D value used in dark measurements.
λ	Selects one of the two laser sources.

Rear Panel

The back of the meter (Figure 4) can vary with the model.

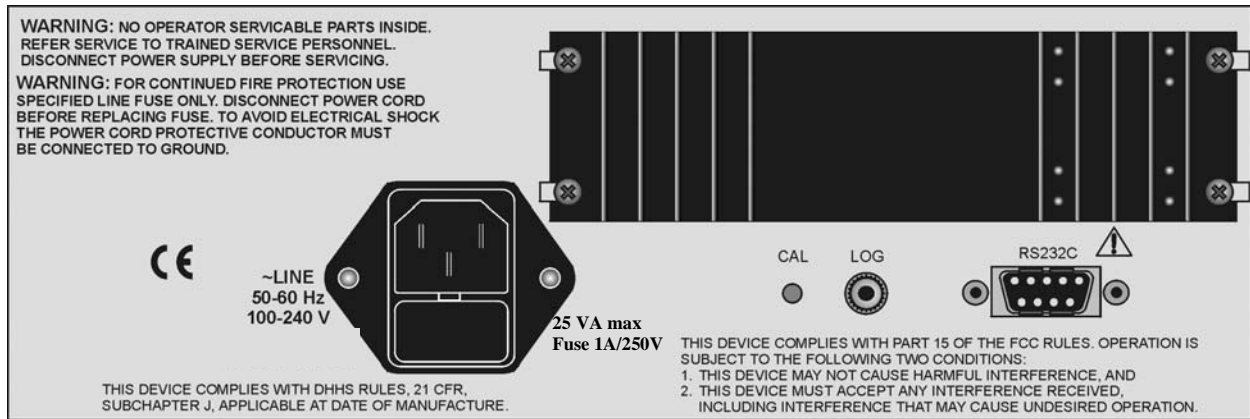

Figure 4: Back of the Meter

The components on the rear panel are described in Table 6.

Table 6: Rear Panel Components

Component	Function
CAL	Access to the User CAL value, for calibration purposes.
LOG	Foot pedal jack for data logging.
RS232C	RS232 serial interface port.

Termination Techniques

Termination is a technique used to block all backreflections beyond a certain point in a network of components. In all measurement testing, two terminations must be made: the first (for measuring BR_0) is made before the DUT, for example, on the RM meter side; the second (for measuring BR_{tot}) is made after the DUT. Both termination points need to be made as close as possible to the DUT to minimize the errors associated with Rayleigh backscattering in the fiber. The backreflection of all components and connections between these two points is included in the equation for calculating the backreflection value (BR) of the DUTs.

Termination Techniques for Single-mode Fiber (except 980 nm)

Termination for single-mode (except 980nm) is performed by mandrel wrapping.

High-attenuation bends in the fiber (bends with a relatively small radius) remove all backreflection and can be made anywhere along the length of the cable. When measuring backreflection levels below -60 dB, low-attenuation bends (bends with a relatively large radius)

need to be made just before the high-attenuation bends in order to offset the small amount of reflection caused by the high-attenuation bends.

- Using the size of rod specified in the Inspection Report (see the **Customized Features and Test Data** section), wind the cable around the rod until the reading displayed on the RM meter no longer changes (approximately six turns). The diameter of the rod must be suitable for the type of fiber connected to the output port jumper and for the wavelength in use. To minimize any memory of the bends in the cable jacket, do not pull on the cable while winding, and occasionally wind the cable in the opposite direction (figure 5a).

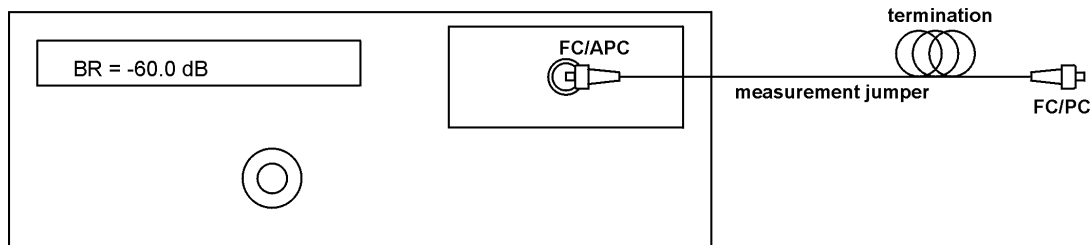

Figure 5a: Terminating the Jumper for BR Measurement for Single-mode (except 980nm)

- The second termination is made after the DUT in order to obtain Br_{tot} (figure 6a).

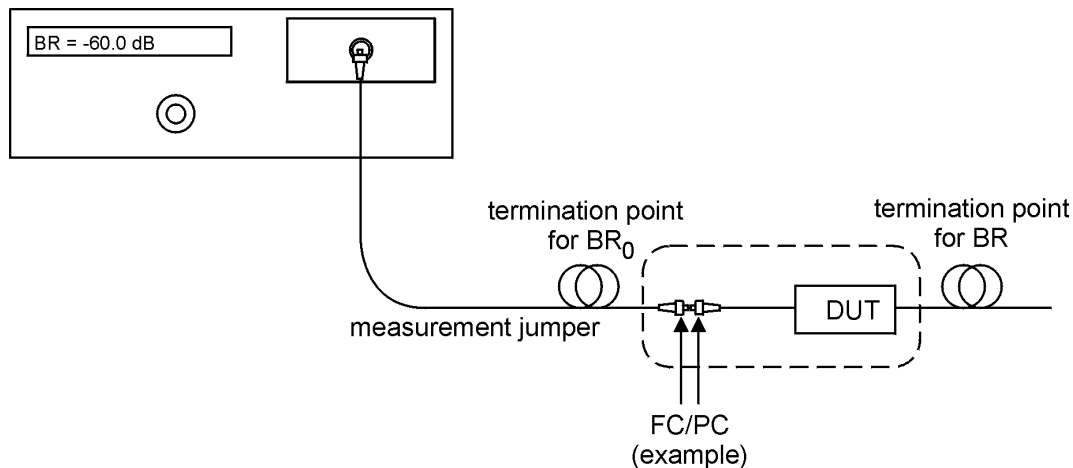

Figure 6a: Measuring Backreflection for Single-mode (except 980 nm)

Termination Techniques for Single-mode (980 nm) and Multimode Fiber

Termination is performed by using index-matching gel.

- Apply index-matching gel directly to the fiber end (figure 5b).
- After measuring BR_0 , clean the connector end in accordance with the **Cleaning Connectors** section.

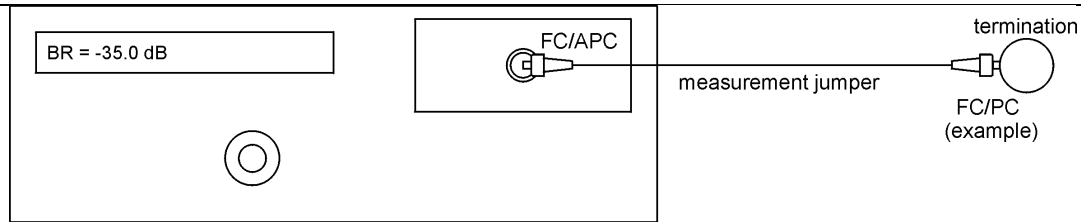

Figure 5b: Terminating the Jumper for BR Measurement for Single-mode (980 nm only) and Multimode

- The second termination is made after the DUT in order to obtain Br_{tot} (figure 6b).

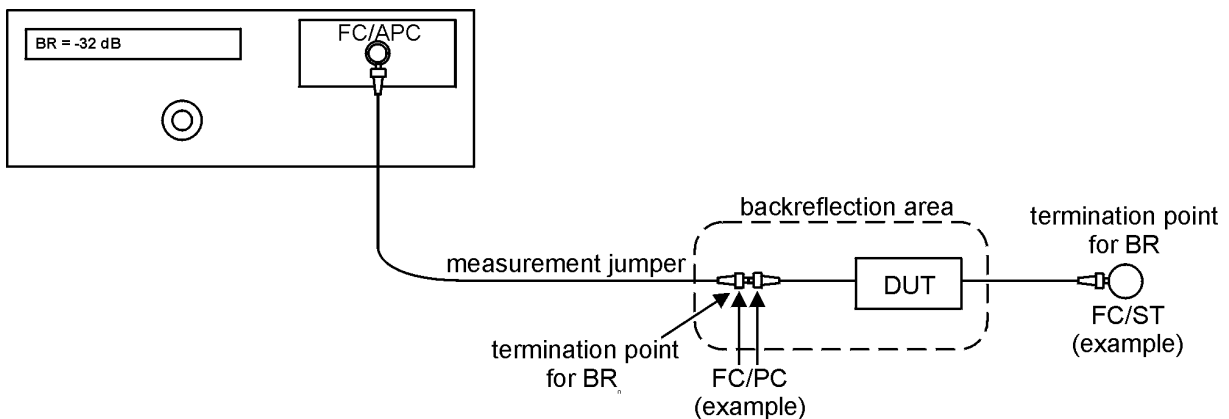

Figure 6b: Measuring Backreflection for Single-mode (980 nm only) and Multimode

Backreflection Measurements

Setting Up the Meter for Backreflection Measurements

To prepare the meter for backreflection measurements:

- Ensure that the meter is powered off.
- Set the power switch to **ON**, and allow the meter to stabilize.
- Press the BR key to set the meter to Backreflection mode, which is displayed as BR on the meter.
- Clean the output port on the front of the meter and the APC connector (green boot) of the measurement jumper, and connect this end of the jumper to the output port. Ensure that you are using the measurement jumper and not the calibration jumper, which is labeled as such. The output connector of the measurement jumper is user-selected and must be compatible with the input connector of the DUT.

For each wavelength at which measurements are to be made:

- Press the λ key to select the required wavelength.

6. Terminate the measurement jumper just before the output connector, and hold the termination point steady (figure 5a for single-mode(except 980nm), and figure 5b for single-mode(980nm) and multimode).

NOTE

The termination technique is different depending on the type of the RM Meter used : single-mode (except 980 nm), single-mode (980nm) or multimode.

Please refer to the **Termination Techniques** section above.

7. Press the Store BR₀ key. The key lamp lights to indicate that the background backreflection has been stored. The BR₀ value is used in the calculation of the DUT backreflection at the selected wavelength.
8. Remove the termination.

Measuring Backreflection

To measure backreflection and power from a unit after setting up the meter (see the **Setting Up the Meter for Backreflection Measurements** section):

1. Clean the output connector of the measurement jumper and the input connector of the DUT, and mate the two.
2. Press the λ key to select the wavelength at which the measurement is to be made.
3. Terminate the measurement jumper immediately after the DUT, and hold the termination point steady. The meter displays the backreflection between the two termination points that is caused by the fiber, all connections, and the DUT. This area is shown within the dashed line in Figure 6a for single-mode (except 980nm), and in Figure 6b for single-mode (980nm) and multimode.
4. If necessary, terminate the fiber for BR₀ again just before the DUT to eliminate the backreflection caused by the fiber and all connections before the DUT.
5. Press the Store BR₀ key. The key lamp lights to indicate that the function is on.
6. If the backreflection setup has been done previously (BR₀ light is on), press the BR₀ button to delete the currently stored BR₀ value. The BR₀ light turns off.
7. Press λ and repeat step 6 to delete the stored BR₀ value for another wavelength.
8. Release the termination. The meter now displays the backreflection of the DUT only.
9. If a measurement is to be made at a second wavelength, repeat steps 1 through 8.

The small amount of reflections that BR₀ represents can be polarization sensitive, and multiple reflections can cause interference effects that can make the reflections very sensitive to

temperature. To ensure accurate backreflection measurements below -65 dB (-25 dB for multimode):

1. Perform the BR₀ measurement at least once per shift.

The measured backreflection is affected by losses that can occur between the meter and the DUT. To compensate for these losses, measure the total amount of loss between the output of the measurement hybrid jumper and the input of the DUT (see the **Loss and Power Measurements** section). Double this value and add it to the backreflection value displayed on the meter. In the following example, the total loss between the meter and the DUT is 2.0 dB, and the displayed backreflection is -29 dB:

$$\text{BR} = -29 \text{ dB} + (2 \times 2.0 \text{ dB}) = -25 \text{ dB}$$

Backreflection Accuracy and Range

The absolute accuracy of backreflection measurements made with the meter is dependent on the level of backreflection to be measured.

The backreflection measurement range is restricted by the BR₀ level. The meter can measure backreflection levels 15 dB below BR₀ to a maximum of -75 dB (-40dB for multimode). For example, if BR₀ is -40 dB, the minimum backreflection of the DUT that can be measured is -55 dB.

An asterisk (*) is displayed near the range limit (last 5 dB of range if using BR₀, below -60 dB otherwise) to indicate that the setup and measurement procedures described in the previous two sections must be followed carefully to ensure accurate results.

Absolute accuracy specifications are dependent upon the accuracy of the RM meter calibration, so a calibration check needs to be performed periodically (see the **Calibrating the Meter** section).

Loss and Power Measurements

Setting Up the Meter for Loss and Power Measurements

To prepare the meter for loss and power measurements:

1. Ensure that the RM meter is powered off.
2. Set the power switch to **ON**, and allow the RM meter to stabilize.
3. Clean the output port on the front of the meter and the FC/APC connector (green boot) of the measurement jumper, and connect this end of the jumper to the output port. Ensure that you are using the measurement jumper and not the calibration jumper, which is labeled as such.

For each wavelength at which measurements are to be made:

4. Press the λ key to select the required wavelength.

5. Attach the appropriate detector adapter to the detector on the front of the meter.
6. Connect the output connector of the measurement jumper to the detector adapter. This end of the measurement jumper is user-selected and must be compatible with the input connector of the DUT.
7. Press the Power key to set the meter to Power mode. When in Power mode, the meter displays P at the beginning of the reading, and no "rel" is displayed, for example, P = -9 dBm.
8. Press and hold the Power key until the display on the meter clears.
9. Release the Power key. The display reads 0.00 dB, and the loss of the measurement jumper is subtracted from the DUT loss or power measurements to be made (Figure 7).

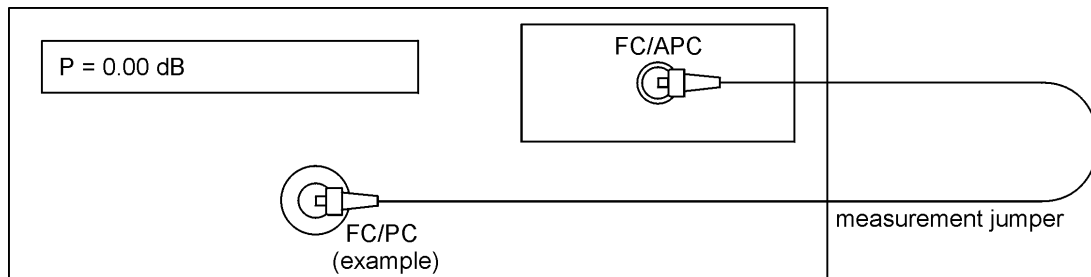

Figure 7: Loss and Power Measurements

For loss and power measurements below -50 dBm:

10. Ensure that the detector is covered, for example, that the detector cap is on or the output connector is connected to the detector. This dark measurement current is subtracted from future loss and power measurements.
11. Press the Store I_D key. The key lamp lights to indicate that the user-stored value of I_D (the dark signal from extraneous sources) is used to calculate the DUT loss or power. If the detector is not sufficiently covered, the message "Too Much Light" is displayed. If the I_D value is not stored before a measurement is made, the last value stored is used.

Measuring Power

In Power mode, absolute power measurements are displayed in dBm. To make a power measurement of a DUT after performing the setup steps in the **Setting Up the Meter for Loss and Power Measurements** section:

1. Press the Power key to set the meter to Power mode.
2. Press the λ key to select the wavelength at which the measurement is to be done.
3. Clean the output connector of the measurement jumper and the input connector of the DUT, and connect the two connectors.

4. Connect the output connector of the DUT to the detector on the front of the meter. The detector must be equipped with the appropriate detector adapter. The RM meter displays the DUT absolute power output (Figure 8).
5. If a measurement is to be made at a second wavelength, repeat steps 2 to 4.

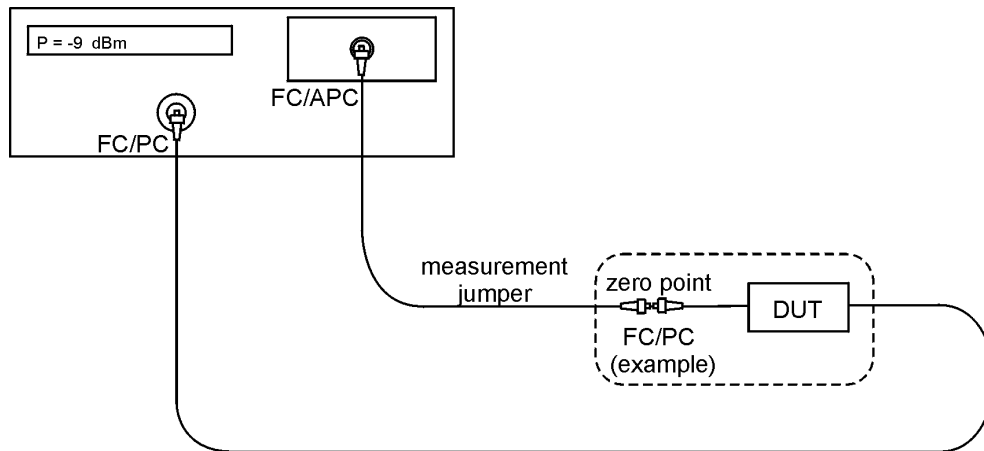

Figure 8: Measuring Absolute Power

Measuring Relative Power (Insertion Loss)

The value for relative power is the negative value of the insertion loss, for example -31 dB instead of 31 dB. Relative power is displayed by the meter in dB.

To make a relative power measurement of a DUT after performing the setup steps in the **Setting Up the Meter for Loss and Power Measurements** section:

1. Press the Power key to set the meter to Relative Power mode. In Relative Power mode, the meter displays P at the beginning of the reading and rel at the end, for example, P = -0.15 dB rel.
2. Press the λ key to select the wavelength at which the measurement is to be made.
3. Clean the output connector of the measurement jumper and the input connector of the DUT, and connect the two connectors. Connect the output connector of the DUT to the detector on the front of the meter. The meter displays the loss due to the DUT (Figure 9).
4. Press the λ key to measure and display the loss at another wavelength.

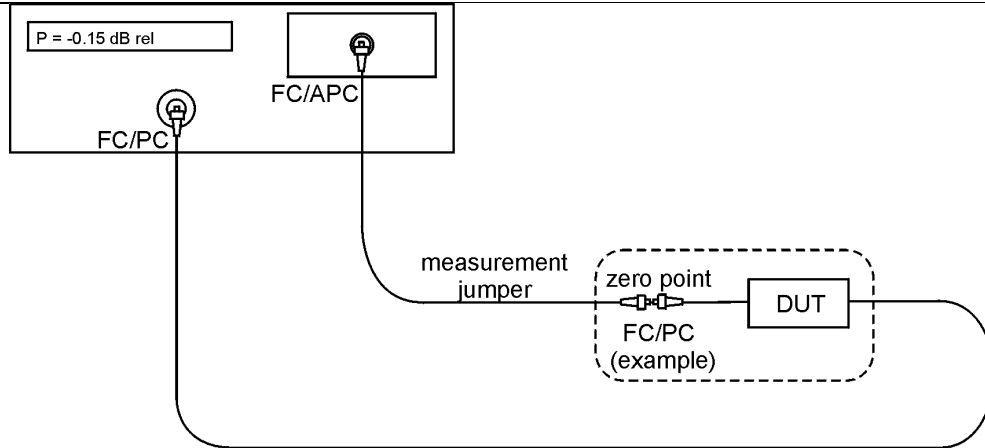

Figure 9: Measuring Relative Power

Power Accuracy

The absolute accuracy of power measurements made with the RM meter is dependent on the power level to be measured. The RM meter does not measure power levels below -50 dBm unless the dark signal from extraneous sources (I_D) is stored.

To ensure accurate power measurements below -65 dBm, store I_D frequently.

The value of I_D can change with temperature fluctuations.

Data Logging Using the Foot Pedal

The RM meter is supplied with a foot pedal for convenient data logging to either a computer or printer. Data logging operates at a baud rate of 2400.

To use the foot pedal:

1. Ensure the computer or printer is connected to the RS232C or IEEE 488 (GPIB) port at the back of the meter.
2. If the foot pedal is not already operational, connect the foot pedal plug to the Log jack on the rear panel of the meter.
3. Press the foot pedal. The message "Log" appears on the right-hand side of the front-panel display, and the most recent measurements made are sent to the computer or printer through the RS232 serial or IEEE 488 (GPIB) port.

Messages and Symbols

The messages and symbols displayed by the RM meter are described in Table 7.

Table 7: RM Meter Display Messages and Symbols

Display	Description
RMXXXXB VERY .Y	Displayed momentarily during the power-up sequence and indicates

Display	Description
	the model number (XXXX) and the software version (Y.Y).
STABILIZING	Displayed momentarily during the power-up sequence as the initial internal reference measurements are made.
BR=-XX.XdB	Backreflection mode.
P=-XX.XXdBm	Power mode.
P=-XX.XXdB rel	Relative Power mode.
*	Displayed when the BR value is within the last 5 dB of range if using BR ₀ , or from -60 to -75 dB if not using BR ₀ .
B	Low battery.
<	P or BR is lower than the minimum value.
>	P is greater than the maximum value.
BR ₀ STORED=-XX.X	Displayed momentarily when the BR value (-XX.XdB) is being stored as BR ₀ .
ID STORED	Displayed momentarily when measuring I _D .
TOO MUCH LIGHT	Displayed momentarily if the I _D value is too high.
INPUT LOW	Displayed momentarily when the laser power is too low.
INPUT HIGH	Displayed momentarily when the laser power is too high.
SOURCE UNSTABLE	Displayed momentarily when the laser power is unstable.
1.3 BR CAL= X.X	Indicates the backreflection user calibration value at 1.3 μm (1.3 μm is taken as an example).
1.5 BR CAL= X.X	Indicates the backreflection user calibration value at 1.5 μm.
1.3 PW CAL= X.XX	Indicates the power user calibration value at 1.3 μm.
1.5 PW CAL= X.XX	Indicates the power user calibration value at 1.5 μm.

Calibrating the Meter

	<p>Caution</p> <p>Devices with malfunctioning lasers must be returned to the manufacturer for calibration.</p>
---	---

Annual calibration of the meter by JDS Uniphase is recommended. This section outlines how to do periodic adjustments to ensure the accuracy of backreflection, loss, and power measurements. Use only the calibrated jumper for all calibration procedures.

Backreflection Calibration Adjustment

The RM meter has a factory-set backreflection calibration value (User CAL) that compensates for the typical loss resulting from a connection to the front-panel FC/APC connector. This value appears in the Inspection Report (see the **Customized Features and Test Data** section).

To perform a backreflection calibration adjustment:

1. Press the BR key to set the RM meter to Backreflection mode, which is displayed as BR on the meter.
2. Clean and connect the APC connector (green boot) of the calibrated jumper to the output port of the RM meter.
3. Press the λ key to select the wavelength at which the calibration check is to be performed. Choose either wavelength, as you will check both.
4. Clean the output connector of the calibrated jumper. The backreflection value is displayed.

The value displayed on the RM meter must match the reference value that appears in the inspection report and on the label of the calibrated jumper. If these values do not match, ensure that the FC/APC connector is properly connected to the RM meter, and clean all the connectors. If the values still do not match to within ± 0.3 dB, adjust the value of User CAL. The CAL key is located on the rear panel of the RM meter.

To adjust the value of User CAL:

1. Use a screwdriver or an appropriately narrow object to press the CAL key on the back of the RM meter. The last User CAL value stored is displayed on the RM meter.
2. Press and hold the Store BR₀ key to scroll to the required value in 0.1 dB increments.
3. Press the CAL key to store the User CAL value and return the RM meter to the backreflection measurement display.

Perform calibration adjustment for the second wavelength:

1. Repeat the calibration adjustment procedure for the second wavelength.

Power Calibration Adjustment

To perform a power calibration adjustment:

1. Press the Power key to set the RM meter to Power mode. In Power mode, the meter displays P at the beginning of the reading, and the value displayed is not followed by "rel". An example is P = -9 dBm.
2. Clean and connect the FC/APC connector (green boot) of the calibrated jumper to the output port of the meter.

3. Press the λ key to select the wavelength at which the calibration check is to be performed. Choose either wavelength, as you will check both.
4. Measure the power from the output of the calibrated jumper, using a high-accuracy, calibrated power meter.
5. Clean the output connector of the calibrated jumper, and connect it to the detector on the front panel of the RM meter. The value displayed on the RM meter must match the value measured by the power meter to within ± 0.3 dBm.

If the values do not match to within ± 0.3 dBm, adjust the value of User CAL:

1. Use a screwdriver or an appropriately narrow object to press CAL. The last User CAL value stored is displayed on the meter.
2. Press and hold the Store I_D key to scroll to the required value in 0.01 dBm increments.
3. Press the CAL key to store the User CAL value, and return the meter to the power measurement display.
4. Repeat the calibration adjustment procedure (steps 1 to 3) for the second wavelength.

Maintaining the Meter

	<p>Caution</p> <p>Devices with malfunctioning lasers must be returned to the manufacturer for repair.</p>
---	--

Cleaning the Unit

1. Unplug the unit from the line power.
2. Clean the enclosure with a damp cloth.
3. DO NOT plug the unit back until it is completely dry.

Cleaning the Connector Ends

Clean all connector ends with a lint-free tissue and alcohol before every mating. See the **Cleaning Connectors** section.

1. Loosen the retaining screws of the connector panel, and remove the panel carefully to access the internal connectors (Figure 10).

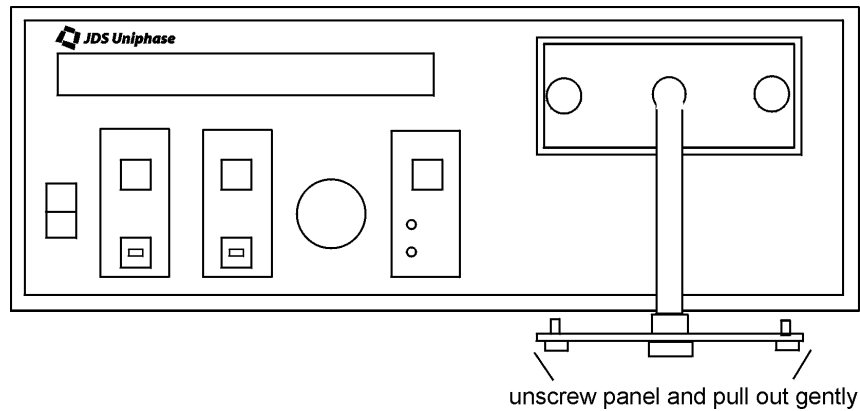

Figure 10: Removing the Connector Panel

2. Remove the connector from the mating sleeve in the panel.
3. Clean the connector endfaces and mating sleeve in accordance with the **Cleaning Connectors** section.
4. Reinstall the connector onto the panel.
5. Reinstall the connector panel. To avoid damaging the input and output port fibers, make one or two large loops in the fibers when replacing the panel.

Recharging the Battery

The letter B is displayed on the RM meter when the battery power is low. To recharge the battery:

1. Connect the meter to the AC source.

The RM meter can be used while it is recharging.

Replacement of Internal Fuses

The following fuses can be replaced by JDSU qualified technicians only:

1. Fuse F1 on battery protection circuit PCB, 250V, F2A.
2. Fuse on battwery cord, 250V, F 1 6/10 A

Troubleshooting

If any problem described in this section persists, contact JDS Uniphase or your local representative.

Every backreflection measurement is affected by the loss before the DUT and by reflections before and after the DUT.

Loss Before the DUT

When a DUT is connected to the RM meter, the loss from connectors before the DUT affects the backreflection reading. Because the light is going out from the RM meter and then returning, it goes through the connectors twice, so the effect of the loss is doubled. If the loss is close to 0.15 dB, its effect is compensated automatically by the meter. If the loss differs substantially from 0.15 dB, follow the measurement procedures described at the end of the **Measuring Backreflection** section.

Reflections Before the DUT

When a device is connected to the RM meter, the reflections from the connectors affect the backreflection reading. The front panel FC/PC connections must have backreflection levels lower than -45 dB for single mode (-25 dB for multi mode), and FC/APC connections must have backreflection levels lower than -60 dB for single mode (-40 dB for multi mode). To ensure that the RM meter automatically compensates for this backreflection, follow the setup procedure described in the **Setting Up the Meter for Backreflection Measurements** section, and ensure that the backreflections do not change from the time of the setup.

Reflections After the DUT

When making a backreflection measurement, the fiber after the DUT must be terminated to eliminate the reflections from the end of the fiber (see the **Termination Techniques** section). For greatest accuracy when making very low backreflection measurements, terminate near the DUT to eliminate reflections from the fiber itself.

Front Panel Connectors

Follow the maintenance procedure described in the **Maintaining the Meter** section, to ensure that the internal pigtail connectors are clean and properly connected to the front panel mating sleeve.

Connector Loss and Backreflection

Ensure that the loss and backreflection of all the connectors are low and stable, complying with the connector specifications.

Internal Backreflection (for single mode model only, except 980 nm model)

To confirm proper operation of the RM meter, terminate the internal cable while using the factory-set BR₀ value (BR₀ key lamp is off). The backreflection reading must be less than -65 dB.

Long Cables (for single mode model only, except 980 nm model)

Terminate the cables near the devices or connectors being tested in order to eliminate backreflections from the fiber.

❑ **Laser Stability**

If the messages “Source Unstable” or “Input Low” are displayed, remove the front connector panel, clean the front panel connectors, connect the internal FC/APC connector to the detector adapter, and press the Power key to set the meter to Power mode. The reading must be steady and higher than -10 dBm. If not, perform the procedure recommended in the table that follows.

❑ **Calibration**

If the backreflection or power calibration was not performed properly, set BR CAL to 0.3 dB and Power CAL to 0 dB to restore the factory-set calibration. These settings provide reasonably accurate backreflection and power measurements.

❑ **Other**

Display	Problem	Solution
	Meter does not turn on	Set the power switch to OFF , connect the RM meter to a power source, and wait a few minutes before turning the power switch on.
STABILIZING	Message is displayed for a long time	Set the power switch to OFF , connect the RM meter to a power source, and then set the power switch to ON .
*	The BR measurement is approaching the range limit of the RM meter	Follow the setup and measurement techniques described in the Setting Up the Meter for Backreflection Measurements and Measuring Backreflection sections.
B	Battery is running low	Connect the RM meter to the a power supply using the cord provided.
<	BR range is very limited	Follow the setup and measurement techniques described in the Setting Up the Meter for Backreflection Measurements and Measuring Backreflection sections.
TOO MUCH LIGHT	I _D value is too high	Attach the detector cap to the detector, and press the I _D key.
INPUT LOW	Laser power is too low	Check the measurement setup for an external source that entered into the output.
INPUT HIGH	Laser power is too high	Check the measurement setup for an external source that entered into the output.

Programming Guide

RS232 Serial Interface

The RM meter is equipped with an RS232 serial interface. Through the RS232 connection, the user can download measured values of backreflection, loss, and power to a computer or printer. The RM meter can also use an IEEE 488 parallel interface through the external RS232-to-IEEE 488 converter (described in the **RS232-GPIB Converter** section).

The RS232 serial interface is configured as data terminal equipment (DTE). The data protocol is set to 2400 baud, ASCII character code with eight bits per character, two stop bits, and no parity bit.

RS232 Pin Assignment

The RS232 pin assignment is shown in Figure 11.

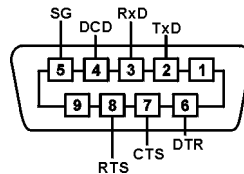

Figure 11: RS232 Pin Assignment

RS232 Interface Specifications

The RS232 interface specifications are listed in Table 8.

Table 8: RS232 Interface Specifications

Name	Symbol	Pin Number	Signal Direction
Transmitted data	TxD	2	→
Received data	RxD	3	←
Request to send	RTS	8	→
Clear to send	CTS	7	←
Data carrier detect	DCD	4	←
Data terminal ready	DTR	6	→
Signal ground	SG	5	↔

To connect the RM meter to the serial port of a computer:

1. Attach a straight-through RS232 cable to the computer and the RS232C port at the back of the meter.

On power-up, the RTS and DTR signals on the interface connector go positive, indicating that the interface is ready to communicate. The software on the controlling computer must enable the RTS line. The interface controller waits for the CTS line to go positive before the measurements are transmitted. The DCD line must go positive in order for the controlling computer to receive commands from the meter.

The meter responds to single character commands sent on the serial interface. The characters must be sent individually, without a message terminating sequence such as <CR> (carriage return) or <LF> (line feed). The meter acknowledges each character that is sent with a character or a measurement reading.

The command G initiates the transmission of a measurement. The meter returns the most recent measurement. The transmission also includes the wavelength at which the measurement was made and the characters <CR> <LF>.

The character commands that control the meter via the RS232 serial interface port are listed in Table 9. When a command is accepted, the letter Y is returned. When a command is not recognized or not accepted, the letter X is returned.

Table 9: Character Commands

Command	Action
B	Display backreflection
A	Display absolute power
R	Display relative power
S	Store BR ₀ ¹
C	Clear BR ₀ ¹
D	Store I _D ²
0	Set relative power to zero ³
3	Set wavelength to the laser connected to the first LED on display (eg. Model RM3750, first laser=1310nm. See Figure 3)
5	Set wavelength to the laser connected to the second LED on display (eg. Model RM3750, second laser=1550nm. See Figure 3)

¹ Valid in Backreflection mode only.

² Valid in Absolute Power and Relative Power modes only.

³ Valid in Relative Power mode only.

RS232-GPIB Converter

An optional user-supplied RS232-to-IEEE 488 converter can be used with the RS232 connector on the RM meter to access an IEEE 488 parallel interface. The converter, supplied with the appropriate RS232 cable, is attached to the RS232 connector on the rear panel.

The converter is set up and tested as described in Table 10 and Table 11. To avoid conflict with other GPIB devices, the GPIB address can be changed.

Left Dip Switch

The settings for the left dip switch are shown in Table 10.

Table 10: Left Dip Switch Settings

Switch	Setting	Meaning
GPIB ADDR	01000	address = 2
CONFIG	ON	use large serial buffer, enable SRQ
MODE	OFF	device mode

Right Dip Switch

The settings for the right dip switch are shown in Table 11.

Table 11: Right Dip Switch Settings

Switch	Setting	Meaning
BAUD RATE	all OFF	set baud rate to 2400
DATA FORMAT	OFF OFF ON ON	odd/even parity disable parity checking use 2 stop bits use 8 bits per character
HANDSHAKE	OFF	disable XON/XOFF protocol

Programming Examples

RS232 Interface Program Example

The following program can be used to connect the RM meter with an external device through the RS232 serial interface.

```
100 CLOSE #1                ' Initialize the RS232C port
110 OPEN "COM1:300,N,8,2" AS #1
200 PRINT #1,"B";          ' Go to Backreflection mode
210 INPUT #1,IN$
220 IF IN$ = "Y" THEN GOTO 250 ' Check if the command was accepted
230 PRINT "WILL NOT DISPLAY BR"
240 STOP
250 FOR I=1 TO 5            '   Read   and   display   five   BR
measurements
260 PRINT #1,"G";
270 INPUT #1,IN$
280 PRINT IN$
290 NEXT I
300 PRINT #1,"A";          ' Go to Power mode
310 INPUT #1,IN$
320 IF IN$ = "Y" THEN GOTO 350 ' Check if the command was accepted
330 PRINT "WILL NOT DISPLAY POWER"
340 STOP
350 FOR I=1 TO 5            ' Read, display five power
measurements
360 PRINT #1,"G";
370 INPUT #1,IN$
380 PRINT IN$
390 NEXT I
400 CLOSE #1
410 END
```

Customized Features and Test Data

Free Manuals Download Website

<http://myh66.com>

<http://usermanuals.us>

<http://www.somanuals.com>

<http://www.4manuals.cc>

<http://www.manual-lib.com>

<http://www.404manual.com>

<http://www.luxmanual.com>

<http://aubethermostatmanual.com>

Golf course search by state

<http://golfingnear.com>

Email search by domain

<http://emailbydomain.com>

Auto manuals search

<http://auto.somanuals.com>

TV manuals search

<http://tv.somanuals.com>