

Jabra®

Jabra PRO™ 930

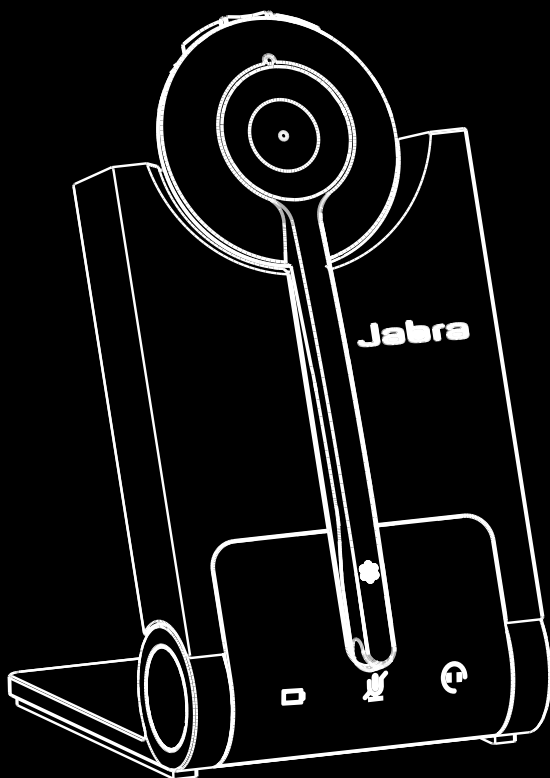

User Manual

www.jabra.com

CONTENTS

1. WELCOME	4
2. PRODUCT OVERVIEW	5
2.1 PACKAGE CONTENTS	5
2.2 HEADSET OVERVIEW	6
2.3 HEADSET ATTACHMENTS	7
2.4 BASE OVERVIEW	8
2.5 OPTIONAL ACCESSORIES	9
3. CONNECTING TO A PC	10
3.1 FOLDABLE BASE STAND	10
3.2 CONNECT TO PC	10
3.3 CONNECT POWER SUPPLY TO BASE	11
3.4 DOCK THE HEADSET	11
4. JABRA PC SUITE	12
4.1 INSTALL JABRA PC SUITE	12
4.2 SET JABRA PRO 930 AS SPEAKER AND MICROPHONE	12
4.3 FIRMWARE UPDATES	12
5. JABRA PRO 930 FEATURES	13
5.1 HEADSET MULTI-FUNCTION BUTTON	13
5.2 HEADSET SPEAKER VOLUME BUTTONS	13
5.3 HEADSET MUTE BUTTON	13
5.4 HEADSET LED INDICATOR	14
5.5 HEADSET AUDIO INDICATORS	14
5.6 BASE VISUAL INDICATORS	15
5.7 BASE AUDIO INDICATORS	15

6.	BASIC CALL MANAGEMENT	16
6.1	MAKING CALLS, ANSWERING CALLS AND ENDING CALLS (SUPPORTED SOFTPHONES ONLY)	16
6.2	CALL WAITING	16
6.3	CONFERENCE CALL WITH MULTIPLE HEADSETS	16
7.	ADVANCED JABRA PRO 930 FEATURES	17
7.1	SAFETONE™ AUDIO PROTECTION	17
7.2	WIRELESS RANGE.....	17
7.3	POWER MANAGEMENT	17
7.4	PC AUDIO DETECTION.....	17
7.5	LISTENING TO MUSIC.....	17
7.6	HOW TO CHANGE ADVANCED SETTINGS	18
7.7	HOW TO RESET ADVANCED SETTINGS.....	19
7.8	COPY SETTINGS TO MULTIPLE JABRA PRO 930 BASES	19
7.9	FORCED PAIRING (PAIRING A NEW PRIMARY HEADSET)	19
8.	SUPPORT.....	20
8.1	FAQS AND TROUBLESHOOTING.....	20
9.	TECHNICAL SPECIFICATIONS	21
9.1	JABRA PRO 930 HEADSET	21
9.2	HEADSET BATTERY	21
9.3	MATERIALS AND ALLERGIES	22
9.4	JABRA PRO 930 BASE	22
9.5	PRODUCT DISPOSAL	22
9.6	CERTIFICATIONS AND SAFETY APPROVALS.....	23

1. WELCOME

Congratulations on purchasing your new Jabra PRO 930. We are sure you will enjoy its wide range of features, and find the headset comfortable to wear and easy to use.

Jabra PRO 930 headset features

- Wideband audio for exceptional sound quality.
- Volume and mute controls.
- Intuitive headset multi-function button for easy call handling.
- LED and audio indicators.
- Advanced hearing protection with SafeTone™.
- Noise-cancelling microphone.
- Auto sleep mode for energy conservation.
- Headband and earhook wearing-styles (earhook not supplied in all regions).

Jabra PRO 930 base features

- Headset recharge docking cradle.
- Visual and audio call status indicators.
- Battery indicator.
- Voice-prompted configuration.

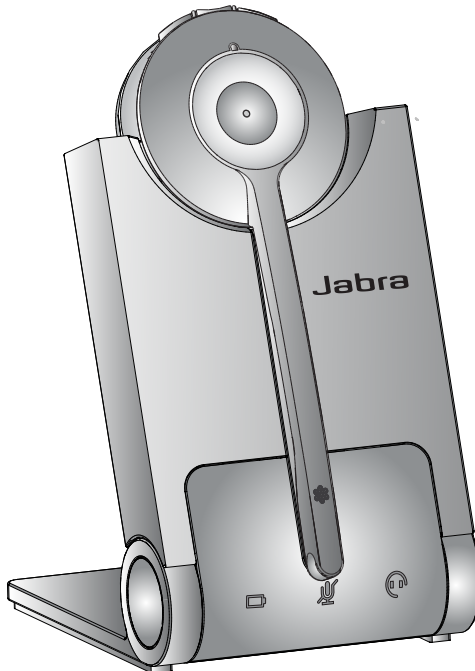

2. PRODUCT OVERVIEW

2.1 PACKAGE CONTENTS



Headset



Headband attachment

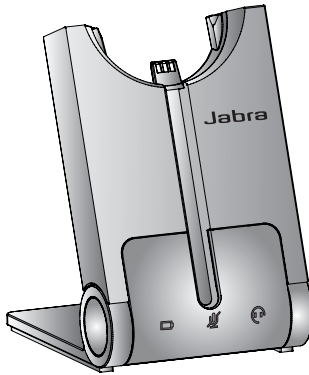

Base



Power adapter

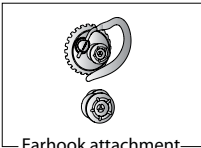

Earhook attachment
(not supplied in all regions)



Quick Start Guide



USB cable



Warning & Declaration
booklet

2.2 HEADSET OVERVIEW

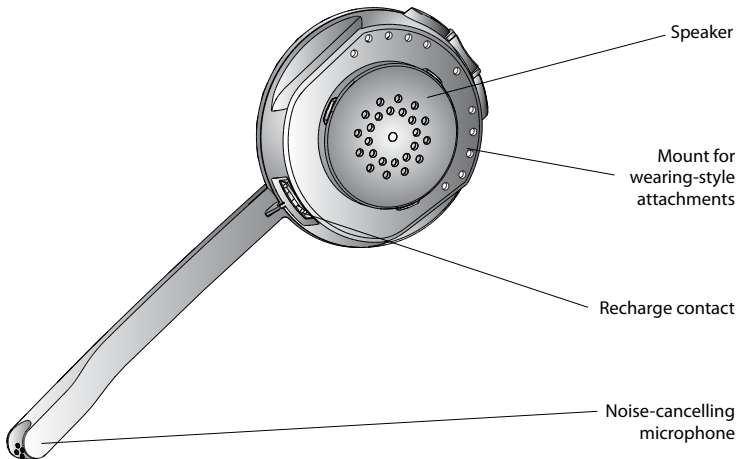
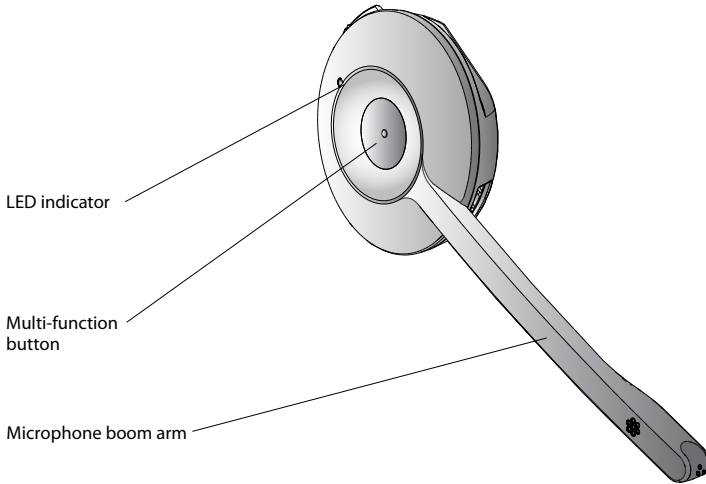
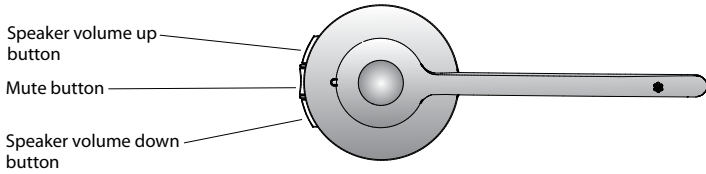

2.3 HEADSET ATTACHMENTS

The Jabra PRO 930 headset can be worn in three different wearing-styles: headband, earhook or neckband. The headband and earhook attachments (earhook not supplied in all regions) are included with the Jabra PRO 930. The neckband attachment can be purchased separately.

All wearing-styles are interchangeable and can be worn on either the left or right ear.

Regardless of wearing-style, position the microphone as close to the mouth as possible for maximum noise-cancelling effect.

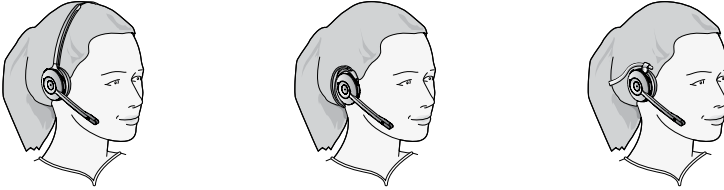

Attaching the headband

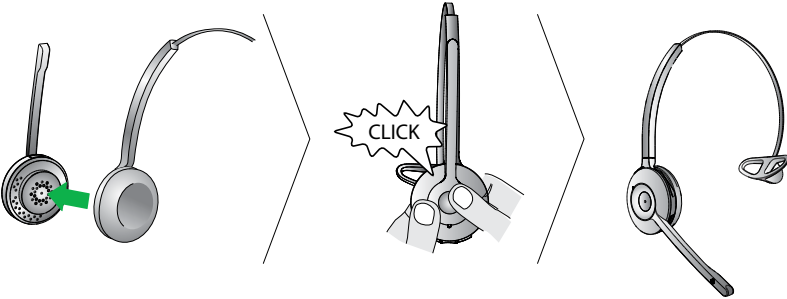

Attaching the earhook (earhook not supplied in all regions)

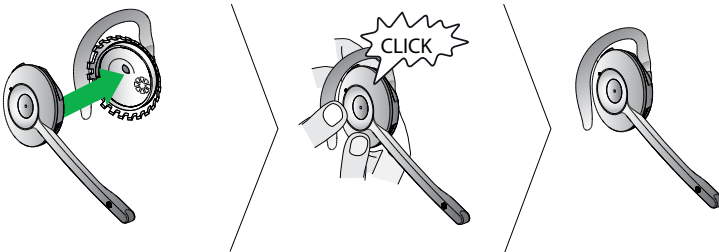

Attaching the neckband (optional accessory)

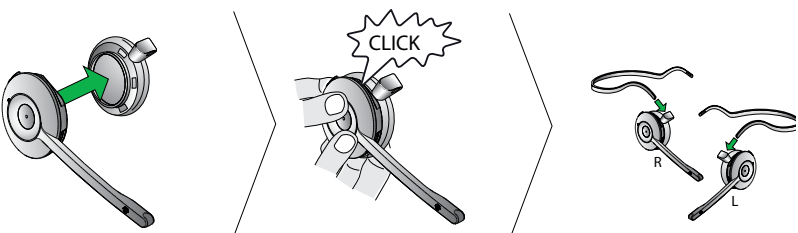

JABRA PRO 930

2.4 BASE OVERVIEW

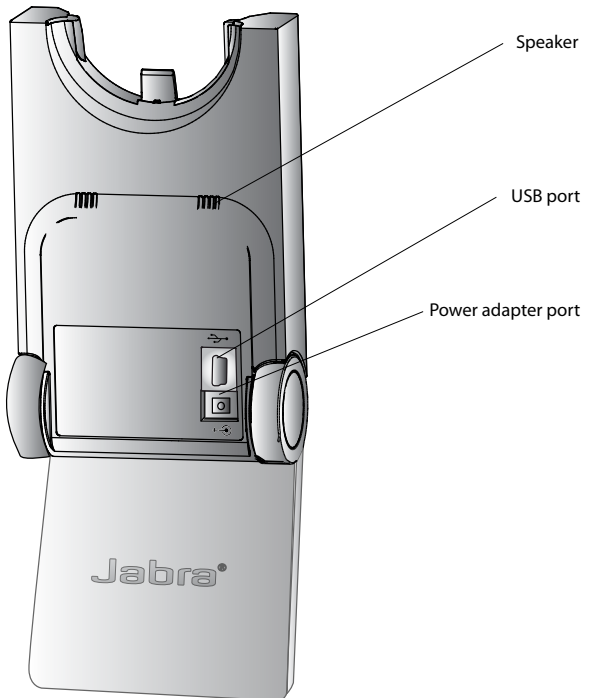
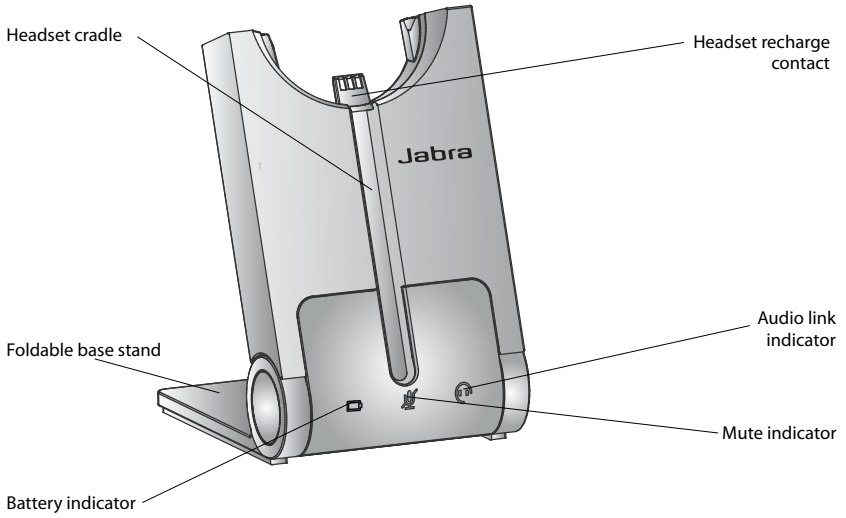

JABRA PRO 930

2.5 OPTIONAL ACCESSORIES

The following Jabra PRO accessories are available separately. Visit jabra.com for full accessory overview.

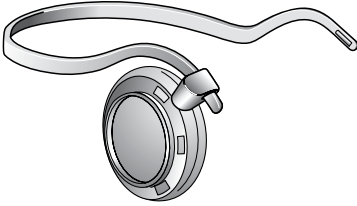

Neckband attachment

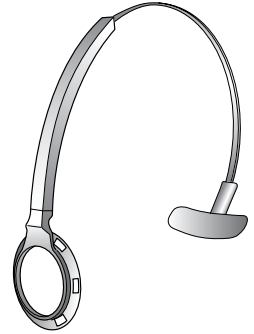

Replacement headband attachment

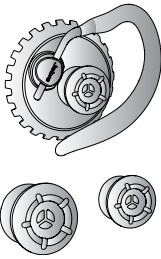

Replacement earhook, with earbuds

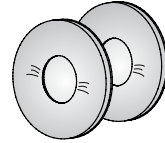

Replacement ear cushions

3. CONNECTING TO A PC

Refer to the Warning and Declaration guide for important safety instructions prior to installation and use of the Jabra PRO 930.

3.1 FOLDABLE BASE STAND

The Jabra PRO 930 base stand can be folded into three positions: open, closed and standing position, as illustrated.

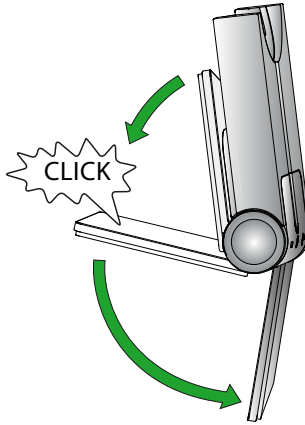

3.2 CONNECT TO PC

1. Plug the USB cable to the port marked  on the base.
2. Connect the USB cable to any free USB port on the PC.

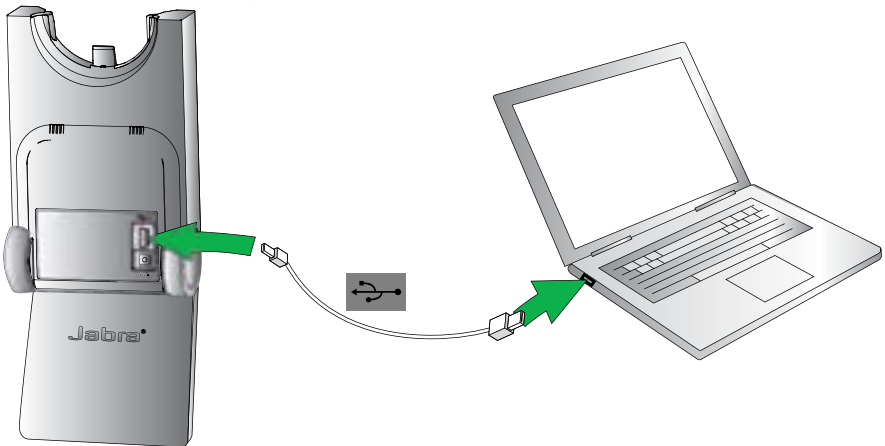

3.3 CONNECT POWER SUPPLY TO BASE

1. Plug the power adapter into the port marked  on the base.
2. Connect the power adapter to the mains power socket.

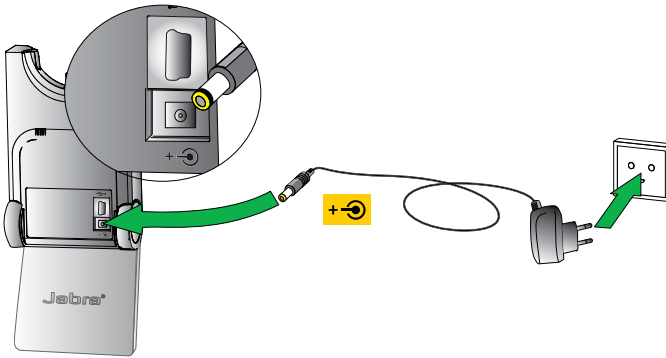

3.4 DOCK THE HEADSET

Dock the headset with the base

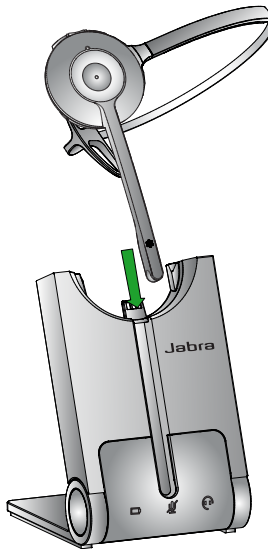

Dock the headset. When docked correctly the headset battery will begin charging, if needed. Charge for 20 minutes or until the battery indicator on the base  is steady green.

4. JABRA PC SUITE

Jabra PC Suite is a collection of software designed to support the Jabra PRO 930. For optimal functionality and management of the Jabra PRO 930, it is highly recommended to install Jabra PC Suite.

Jabra PC Suite consists of:

Jabra Control Center

Settings management and monitoring of the Jabra PRO 930.

Jabra Device Service

Manages the interaction between the Jabra PRO 930 and Jabra Control Center and softphone drivers.

Jabra Firmware Updater

Updates Jabra PRO 930 firmware.

Online Help

Searchable help for Jabra PC Suite.

Jabra PC Suite additionally includes drivers for various softphones. For a list of supported softphones, visit the Jabra website at www.jabra.com/pcsuite

4.1 INSTALL JABRA PC SUITE

To install Jabra PC Suite download the latest version from the Jabra website at www.jabra.com/pcsuite

4.2 SET JABRA PRO 930 AS SPEAKER AND MICROPHONE

Before first time use of the Jabra PRO 930, it is important to set the Jabra PRO 930 as speaker and microphone in the audio configuration section of your softphone software (e.g. Skype). Refer to specific softphone documentation for assistance in setting audio configurations.

4.3 FIRMWARE UPDATES

Firmware updates improve performance, or add new functionality, to your Jabra PRO 930.

Update firmware

- Launch the Jabra Firmware Updater installed with Jabra PC Suite, and follow the Firmware Updater wizard, or
- Check for the latest version via **Jabra Control Center > Help > Check for Updates**.

When the base is in firmware update mode, the battery icon will change to purple.

5. JABRA PRO 930 FEATURES

5.1 HEADSET MULTI-FUNCTION BUTTON

The multi-function button can answer calls and end calls using a combination of taps, double-taps or presses.

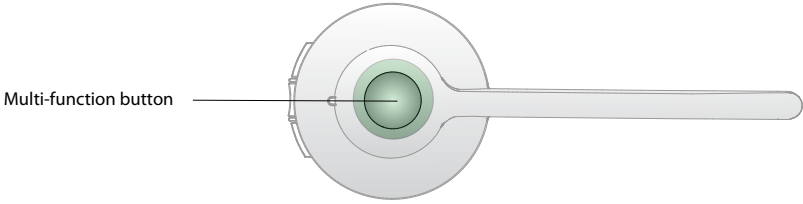

Function	Tap	Double-tap	Press and hold (1-3 seconds)
Answer incoming call	✓		
End current call	✓		
Reject incoming call		✓	
Put current call on hold, and accept incoming call (not supported by all softphones)			✓
Power on	✓		
Power off			✓ (5 secs)

5.2 HEADSET SPEAKER VOLUME BUTTONS

The speaker volume buttons adjust the headset speaker volume.

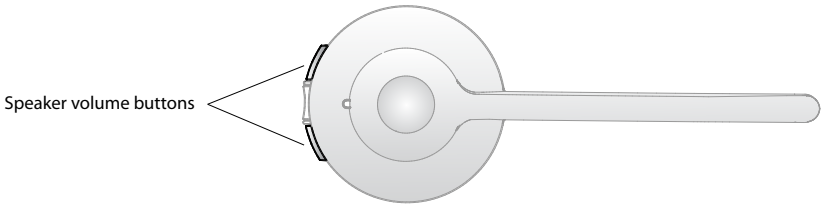

5.3 HEADSET MUTE BUTTON

The mute button mutes or un-mutes the headset microphone.

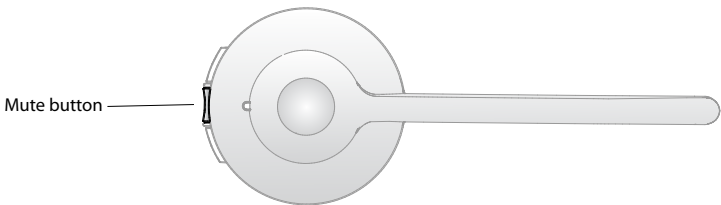

5.4 HEADSET LED INDICATOR

The LED indicator indicates call status.

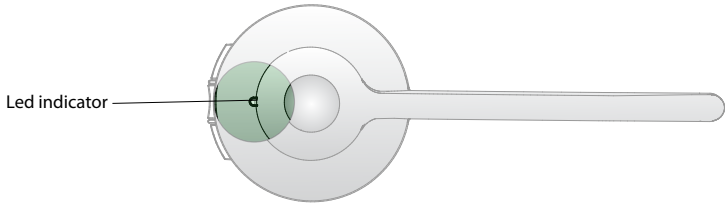

Headset state	LED sample (click to view)	Headset state	LED sample (click to view)
Connected		Headset docked in base	
Not connected		Headset docked in charger	
Active call		Headset docked in unknown base	
Incoming call		Settings copying	
Power on		Settings copied	
Power off		Settings cannot be copied	
Pairing		Firmware updating	

5.5 HEADSET AUDIO INDICATORS

The headset plays a variety of voice announcements and audio tones to indicate headset status and actions.

Audio tones	Audio Sample (click to listen)	Audio tones	Audio sample (click to listen)
Power on		Microphone muted	
Power off		Call ended	
Button tap		Battery low	
Button double-tap		Conference start	
Button press		Conference end	
Maximum speaker volume reached		Out of range	
Minimum speaker volume reached		Incoming call accepted	

Voice prompt	Audio Sample (click to listen)	Voice prompt	Audio sample (click to listen)
Setup		Peakstop and intellitone	
Audio protection		Peakstop	
Wireless range		Normal	
Auto sleep mode		Low	
Goodbye		Very low	
Factory default		On	
		Off	

5.6 BASE VISUAL INDICATORS

The Jabra PRO 930 base has three LEDs to indicate battery level, call status and events.

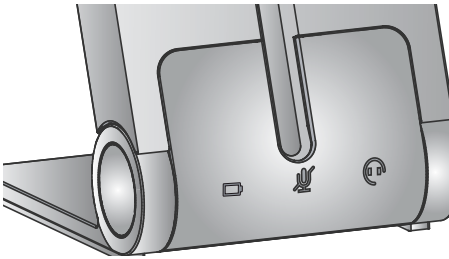

Icon	Event
	Battery charging (slow flash)
	Full battery
	Low battery
	Very low battery (fast flash)
	Sleep mode (slow flash)
	Unknown battery status
	Microphone muted
	Active audio link between headset and base
	Searching for headset

5.7 BASE AUDIO INDICATORS

The base speaker is located on the rear of the base, and plays audio tones to indicate when the base is powered on, and when there is an incoming call. The incoming call ringtone volume is set to medium by default, and can be changed using Jabra Control Center.

6. BASIC CALL MANAGEMENT

6.1 MAKING CALLS, ANSWERING CALLS AND ENDING CALLS (SUPPORTED SOFTPHONES ONLY)

How to do	
Make call	1. Lift headset from docking cradle, or tap the multi-function button. 2. Dial number using softphone application.
Answer call	Lift headset from docking cradle, or tap the multi-function button.
Reject call	Double-tap the headset multi-function button.
End call	Dock the headset, or tap the multi-function button.

6.2 CALL WAITING (SUPPORTED SOFTPHONES ONLY)

Call waiting allows a current softphone call to be placed on hold, and an incoming softphone call to be answered. Check specific softphone documentation for call waiting compatibility.

Call waiting can be managed on the headset or the base.

	Multi-function button
Accept incoming call, and put current call on hold.	Press (1-2 secs).
Accept incoming call, and end current call.	Tap.
Reject incoming call, and remain on current call.	Double-tap.
Switch between current call, and call on hold.	Press (1-2 secs).

6.3 CONFERENCE CALL WITH MULTIPLE HEADSETS

The Jabra PRO 930 is able to pair with four headsets in total for conferencing: one primary and three secondary headsets (narrowband only).

Connect secondary headset

1. While the primary headset is undocked and on a call, dock the secondary headset with the base hosting the call. When the headsets are successfully paired, a double-tone will sound in the primary headset.
2. Tap the multi-function button on the primary headset to accept the secondary headset. The audio is now shared between headsets.

Ending, or leaving, the conference

The primary headset user can end the conference by hanging up on the call. The call is ended for all headsets.

Guests can leave the conference by pressing the multi-function on their headset, or by docking the headset with the base. The conference call is still active for the other headset(s).

7. ADVANCED JABRA PRO 930 FEATURES

7.1 SAFETONE™ AUDIO PROTECTION

SafeTone™ provides effective hearing protection against potential risks, such as acoustic shock and noise exposure. SafeTone™ consists of two components, PeakStop™ and IntelliTone™ and can be set using Jabra Control Center, or via the Jabra PRO 930 headset (see Section 7.6).

PeakStop™ acoustic shock protection

PeakStop™ automatically suppresses sounds over 118dB(A), protecting hearing from acoustic shock.

IntelliTone™ noise-exposure protection

IntelliTone™ offers protection against acoustic shock and noise exposure over 85dB(A), corresponding to up to 8 hours of daily talk.

7.2 WIRELESS RANGE

The Jabra PRO 930 supports a maximum wireless range of up to 120 meters. Physical obstructions and electromagnetic interference may shorten this range. The wireless range can be adjusted to prevent interference with other wireless devices (see Section 7.6).

Headset sound quality may deteriorate the further the headset is from the base, and may improve the closer the headset is to the base. When the headset is completely out of range, a unique tone will be played in the headset every few seconds.

If the headset is on a call when moved out of range, the audio will be lost; however the call will remain active at the base for 120 seconds. To restore audio to the call, move the headset into range of the base.

If the headset remains out of range of the base for more than an hour, the headset will power down to conserve battery.

7.3 POWER MANAGEMENT

The Jabra PRO 930 provides several built-in power management features for conserving energy.

Auto sleep mode

Auto sleep mode can be enabled using the Jabra PRO 930 base (see Section 7.6). Auto sleep mode is off by default. When enabled, the Jabra PRO 930 will automatically enter sleep mode after 8 hours of inactivity, as indicated by the battery indicator slow flashing blue. Sleep mode will end when docking or undocking the headset.

NOTE: If the USB cord is disconnected from the PC or the PC goes into sleep mode, the base will automatically enter sleep mode.

Automatic headset power off

After 60 minutes of no audio link between headset and base, the headset will automatically power off. To power the headset on, tap the multi-function button.

7.4 PC AUDIO DETECTION

The Jabra PRO 930 can be configured to automatically open an audio link between headset and PC when sound is detected on the PC. Automatic PC audio detection is default-enabled.

Enable/Disable PC audio detection

1. Launch Jabra Control Center, and select the 'Softphone (PC)' tab.
2. Select the relevant setting under 'PC audio control', and then click Apply.

7.5 LISTENING TO MUSIC

Music played on a PC connected to the Jabra PRO 930 will automatically play in the headset. Alternatively double tap the multi-function button to keep the audio link open.

7.6 HOW TO CHANGE ADVANCED SETTINGS

Three advanced settings can be configured using the base. Voice prompts indicate the current setting and value. The three settings are:



- Audio protection.
- Wireless range.
- Auto sleep mode.



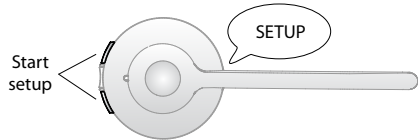





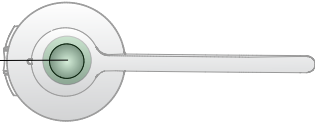
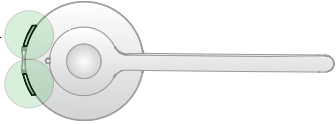

1 Start setup mode

- Put on the headset.
- Simultaneously press and hold both headset volume buttons until the voice prompt says “Setup” and then release the buttons.



2 Setup mode

- The headset buttons are used to cycle through the settings and values.
- The base lights  , or voice prompts are used to indicate which setting and value is currently selected.

Settings		Values	
			
Base light	Setting	Base light	Value
 flash x1	Audio protection		Peakstop (default)
 flash x2	Wireless range		Peakstop and IntelliTone
			Normal (default)
			Low
 flash x3	Auto sleep mode		Very low
			Off (Default)
			On

3 End setup mode

When finished, simultaneously press and hold both headset volume buttons until the voice prompt says “Goodbye” and then release the buttons.

The base will restart and update the settings, indicated by the white battery icon  on the base.



7.7 HOW TO RESET ADVANCED SETTINGS

- Put on the headset.
- Simultaneously press and hold the mute button and both headset volume buttons until the voice prompt says "Factory default" and then release the buttons.

The base will restart and reset the settings, indicated by the white battery icon  on the base.



7.8 COPY SETTINGS TO MULTIPLE JABRA PRO 930 BASES

Jabra PRO 930 settings can be manually copied onto other Jabra PRO 930 bases.

1. Dock headset in the base.
2. Press and hold the headset mute button until the headset LED flashes, and then release. When the settings have successfully copied, the headset LED will turn solid white.
3. Undock the headset and dock in the new base to copy the settings to the new base. The headset LED will flash 5 times to indicate the settings are being copied, and then will turn solid white when successfully copied to the new base.
4. To copy the settings to multiple bases, repeat step 3.
5. When finished copying settings, redock the headset with the original base (primary base), or press and hold the headset mute button until the headset LED flashes and then release.

7.9 FORCED PAIRING (PAIRING A NEW PRIMARY HEADSET)

It is possible to force the Jabra PRO 930 to pair with a new headset, even when it is currently paired with another headset.

1. Dock the new headset in the base.
2. Press the multi-function for 1-2 seconds. The headset LED will begin to flash. Forced pairing will take between 10 seconds - 2 minutes.
3. When paired successfully, the battery indicator will turn green (or red if the headset battery is low).

8. SUPPORT

8.1 FAQs AND TROUBLESHOOTING

Q How do I pair my headset with the Jabra PRO 930 base?

A Dock the headset with the base to initiate pairing. Pairing will occur automatically, unless the base is currently linked with a primary headset (a headset already paired with the base). Alternatively you can force pair a new primary headset, if there is currently a primary headset already paired with the base.

Q Can I pair my headset directly with a third-party DECT phone, or base?

A No. The headset can only be paired with a Jabra PRO 930 base.

Q Why doesn't my computer detect the Jabra PRO 930?

A Try connecting the base to another USB port on the PC. It is recommended to have a direct connection between the base and USB port (without a USB hub). If available, run the softphone audio wizard.

Q Why doesn't my headset work with my softphone?

A Check the following:

- Ensure the headset battery is charged. The base battery icon will be blinking green when charging, or solid green when charged.
- Ensure the headset is in range of the base. The range is up to 120 m, depending on environment.
- Ensure the headset and base are paired. To initiate pairing, dock the headset.
- Ensure the Jabra 930 is selected and configured in your softphone settings.

Q Why can I not hear sound or listen to music from my PC in my headset?

A Check the following

- Ensure the Jabra PRO 930 is set as the current audio device in Windows Sound and Audio Devices control panel, and in your softphone software.
- Ensure the audio link to your PC is active. Right-click the Jabra Device icon in the Windows taskbar, and select Open Audio Link, or double-tap the multi-function button on the headset.

Q Is it possible to set up an automatic dial tone for my softphone when I undock my headset?

A Yes, for supported softphones the Jabra PRO 930 can be configured to automatically get a dial tone when the headset is undocked.

1. Launch Jabra Control Center, and select the 'Softphone' tab.
2. Select/deselect the 'Open link when headset is undocked' setting, and then click Apply.

Q What is the range on the Jabra PRO 930?

A Jabra PRO 930 supports a maximum range of up to 120 m (base to headset). Range will vary depending on the environment the headset is used.

Q Can I make a conference call using multiple headsets?

A Yes, the Jabra PRO 930 is able to pair with four headsets in total for conferencing: one primary, and three secondary headsets (narrowband) or one secondary headset (wideband).

Q Can I password protect my settings

A Yes, you can password protect your settings in Jabra Control Center. If password protection is on, you cannot change your advanced settings or reset the Jabra PRO 930 to the factory default settings.

Q Can I turn the headset off to save power when I'm away from the base?

A Yes. Press and hold the headset multi-function button on the headset for five seconds to power the headset off. To power the headset back on, dock the headset with the base, or tap the multi-function button.

Q What is the talk time for a Jabra PRO 930 headset?

A Wideband is up to 6 hours talk time. Narrowband is up to 8 hours talk time.

Q My headband/earhook/neckband is broken. How do I purchase another one?

A Please contact your local Jabra supplier.

9. TECHNICAL SPECIFICATIONS

9.1 JABRA PRO 930 HEADSET

Operating environment:

0°C to +40°C; Up to 95% RH non-condensing.

Call control:

Multi-function button support for answer call, end call, reject call, docking operations also answer and end calls.

Volume control and microphone mute:

Button controls on headset.

Visual indicator:

LED indicates call status, pairing status and other events.

Audio indicators:

Tones indicate incoming calls, low battery, volume level, microphone muting and other events.

Sound quality:

DSP noise reduction; echo cancellation; tone control; wideband audio.

Recharge:

While docked in the Jabra PRO 930 base.

Wireless standard:

(CAT - iq) European DECT and U.S. DECT.

DECT range:

For European DECT; up to 120 meters from Jabra PRO 930 base to headset.

For U.S. DECT; up to 350 feet from Jabra PRO 930 base to headset.

DECT frequencies:

US DECT: 1.92 - 1.93 GHz.

EU DECT: 1.88 - 1.90 GHz.

Wearing-styles:

Headband, and earhook (earhook not supplied in all regions). Neckband is available as an accessory.

Microphone boom arm style:

Midi.

Speaker(s):

Wideband speaker.

Microphone:

Noise-cancelling microphone.

9.2 HEADSET BATTERY

Battery type:

Lithium Ion-polymer.

Battery capacity:

295 mA/h, typical.

Battery talk time:

Up to 8 hours.

Battery lifetime:

Minimum 1000 charge cycles.

Battery standby time:

At least 36 hours.

Operating temperature range:

-20°C to +60°C.

Note: The headset features a temperature-dependant charging algorithm that prevents the battery from being charged during extreme temperatures (below 0° and above 45°C).

Battery charge time:

20% charge in less than 20 minutes.

50% charge in less than 45 minutes.

Full charge in less than 3 hours.

Battery shelf life:

Headset battery holds charge for at least 6 months in the off state, before recharge is required.

9.3 MATERIALS AND ALLERGIES

The headband attachment is made of stainless steel and does not have a nickel-coated surface. Nickel release from the headband is 0.02 µg/cm²/week, which is below the 0.50 µg/cm²/week limit established by EU Directive 94/27/EF. The stainless steel alloy was tested for nickel release in accordance with the European standard EN 1811:1998.

Other wearing-style attachments are made of plastic and contain no known allergens. The ear cushions do not contain vinyl. The products contain no nickel, chrome or natural rubber that can come into contact with users' skin.

9.4 JABRA PRO 930 BASE

The Jabra PRO 930 base meets the following specifications.

Dimensions:

118 mm x 76 mm x 29 mm.

Wireless standard:

(CAT - iq) European DECT and U.S. DECT.

Operating environment:

0°C to +40°C; Up to 95% RH non-condensing.

Recharge cradle:

Fits supplied Jabra PRO 900 series headset.

Audio:

Built-in speaker provides ring tones and/or audio feedback for keypad operation.

PC connector:

Mini USB.

Firmware update:

Downloadable from web, or via Jabra PC Suite.

PC-based configuration:

All settings can be stored and loaded from a PC for backup and mass deployment.

Softphone support:

Full call handling for Skype, Microsoft Office Communicator and Cisco IP Communicator; for other softphones see headset as a standard sound card; support for additional softphones may be added via driver updates for the PC. For the latest updates, see jabra.com/pcsuite on the web.

9.5 PRODUCT DISPOSAL

Please dispose of the headset according to local regulations and recycle when possible. Do not dispose as household waste. Do not dispose of the headset in a fire as the battery may explode. Batteries may also explode if damaged.

9.6 CERTIFICATIONS AND SAFETY APPROVALS

CE

This product is CE marked according to the provisions of the R & TTE Directive (99/5/EC). Hereby, GN declares that this product is in compliance with the essential requirements and other relevant provisions of Directive 1999/5/EC. For further information, please consult <http://www.jabra.com>.

Within the EU, this device is intended for use in Austria, Belgium, Cyprus, Czech Republic, Denmark, Estonia, Finland, France, Germany, Greece, Hungary, Ireland, Italy, Latvia, Lithuania, Luxembourg, Malta, Poland, Portugal, Slovakia, Slovenia, Spain, Sweden, The Netherlands, United Kingdom, and within EFTA in Iceland, Norway and Switzerland.

FCC

This device complies with part 15 of the FCC Rules. Operation is subject to the following two conditions: (1) This device may not cause harmful interference, and (2) this device must accept any interference received, including interference that may cause undesired operation.

Users are not permitted to make changes or modify the device in any way. Changes or modifications not expressly approved by Jabra will void the user's authority to operate the equipment.

This equipment has been tested and found to comply with the limits for a Class B digital device, pursuant to part 15 of the FCC Rules. These limits are designed to provide reasonable protection against harmful interference in a residential installation. This equipment generates, uses and can radiate radio frequency energy and, if not installed and used in accordance with the instructions, may cause harmful interference to radio communications. However, there is no guarantee that interference will not occur in a particular installation. If this equipment does cause harmful interference to radio or television reception, which can be determined by turning the equipment off and on, the user is encouraged to try to correct the interference by one or more of the following measures:

- Reorient or relocate the receiving antenna.
- Increase the separation between the equipment and receiver.
- Connect the equipment into an outlet on a circuit different from that to which the receiver is connected.
- Consult the dealer or an experienced radio/TV technician for help.

The user must place the base 8" (20 cm) or more from any personnel in order to comply with FCC RF exposure requirements.

Industry Canada

Operation is subject to the following two conditions: (1) This device may not cause interference and (2) This device must accept any interference, including interference that may cause undesired operation of the device. The term "IC:" before the certification/registration number only signifies that registration was performed based on a Declaration of Conformity indicating that Industry Canada technical specifications were met. It does not imply that Industry Canada approved the equipment.

Patents and design registration pending international

Jabra

A BRAND BY

GN Netcom

© 2011 GN Netcom A/S. All rights reserved. Jabra® is a registered trademark of GN Netcom A/S. All other trademarks included herein are the property of their respective owners. (Design and specifications subject to change without notice).

MADE IN CHINA
Type: WHB003



www.jabra.com

Free Manuals Download Website

<http://myh66.com>

<http://usermanuals.us>

<http://www.somanuals.com>

<http://www.4manuals.cc>

<http://www.manual-lib.com>

<http://www.404manual.com>

<http://www.luxmanual.com>

<http://aubethermostatmanual.com>

Golf course search by state

<http://golfingnear.com>

Email search by domain

<http://emailbydomain.com>

Auto manuals search

<http://auto.somanuals.com>

TV manuals search

<http://tv.somanuals.com>