

JADE™ Economizer Module (MODEL W7220)

INSTALLATION INSTRUCTIONS



This document describes wiring, power up, basic troubleshooting, and common installation issues for the JADE™ Economizer Module (Model W7220). For further information on mounting and operation, refer to Honeywell document 63-2700.

BEFORE INSTALLATION

Review the following before installing the The W7220:

Electrical

Rated Voltage: 20 to 30 Vac RMS; 50/60 Hz
Transformer: 100 VA maximum system input

Relay Digital Output Rating: 30 Vac

IMPORTANT

All inputs and outputs must be Class 2 wiring.

Inputs

A Mixed air (MA) analog sensor is required on all W7220 units; either an OA (Outdoor Air) sensor for dry bulb change over or an OA Sylkbus sensor for outdoor enthalpy change

over is required in addition to the MA sensor. An additional Return Air (RA) Sylkbus sensor can be added to the system for differential enthalpy changeover.

DCV (CO₂) Sensor (C7232): 2-10 Vdc control signal; minimum impedance >50k ohm.

Outputs

Actuator signal: 2-10 Vdc; minimum actuator impedance is 2k ohm; Sylkbus two-wire output for Honeywell Sylkbus communicating actuators.

Exhaust fan, Y1, Y2 and AUX1 O: Contact closure (24 Vac)
All Relay Outputs (at 30 Vac):
Running: 1.5A maximum
Inrush: 7.5A maximum

When Installing This Product

1. Read these instructions carefully. Failure to follow them could damage the product or cause a hazardous condition.
2. Check ratings given in instructions and on the product to ensure the product is suitable for your application.
3. Installer must be a trained, experienced service technician.
4. After installation is complete, check out product operation as provided in these instructions.

Accessories

50048926-001 2-pin edge connector for sensors
(20 pieces per bag)

50048926-002 6-pin edge connector for field wiring
(20 pieces per bag)

C7250 20k sensor for MA or OA (dry bulb changeover)

C7400S Sylkbus sensor for enthalpy control in OA and/or RA and RA for differential dry bulb changeover

W7220 PCMOD interface tool for JADE controller and Personal Computer. Go to www.customer.honeywell.com/economizertools for the software

50053060-001 Duct mounting kit for sensors



62-0331-07

INSTALLATION AND SETUP

The Economizer module may be mounted in any orientation. However, mounting in the orientation shown above permits proper viewing of the LCD display and use of the keypad.

NOTE: Jade will be in the "set up" mode for the first 60 minutes after powered. If a sensor for OA air or Sylkbus device (sensor, actuator) is disconnected during the set up mode, the Jade will not alarm that failure. The MA sensor is a system "critical" sensor; if the MA sensor is removed during the set up mode, the Jade will alarm. After 60 minutes the Jade controller will change to operation mode and all components removed or failed will alarm in the operation mode.

WIRING

All wiring must comply with applicable electrical codes and ordinances, or as specified on installation wiring diagrams. Module wiring in the field is terminated to the four screw terminal blocks located on the left and right sides.

Module wiring at the OEM factory is terminated via the header pin terminals located on the left and right sides. The header terminal pins and the terminal blocks have common terminations for the appropriate input or output. The part number for the OEM female mating connector is 0039973997.



WARNING

Electrical Shock Hazard.

Can cause severe injury, death or property damage.

Disconnect power supply before beginning wiring, or making wiring connections, to prevent electrical shock or equipment damage.



CAUTION

Equipment Damage Hazard.

Electrostatic discharge can short equipment circuitry.

Ensure that you are properly grounded before handling the unit.

Each terminal can accommodate the following gauges of wire:

- Single wire – from 18 AWG to 22 AWG solid or stranded
- Multiple wires – up to two 22 AWG stranded
- For the 24 Vac connections: single wire – from 14 to 18 AWG solid or stranded

For S-BUS wiring, the sensors may be mounted up to 200 ft. (61 m) from the JADE controller. When the length of wire is over 100 feet use twisted pair shielded wire.

NOTE: All wiring is polarity insensitive.

Refer to Fig. 1 through Fig. 6 for common wiring configurations.

Actuator Wiring Options:

1. The JADE economizer controller can only have one (1) communicating actuator connected to it.
2. Up to four (4) non-communicating and (2) 2-position actuators (1 each on EXH1 and AUX1 O)
3. One (1) communicating and up to four (4) non-communicating and (2) 2-position actuators (1 each on EXH1 and AUX1 O)

When using a 2-position actuator on the AUX1 O the AUX1 O must be programmed for Exh2 and the % open is the % open of the outdoor damper when the 2-pos actuator opens. Connect 24 V to Exh1 and/or AUX1 O and ground to the Jade "C" terminal.

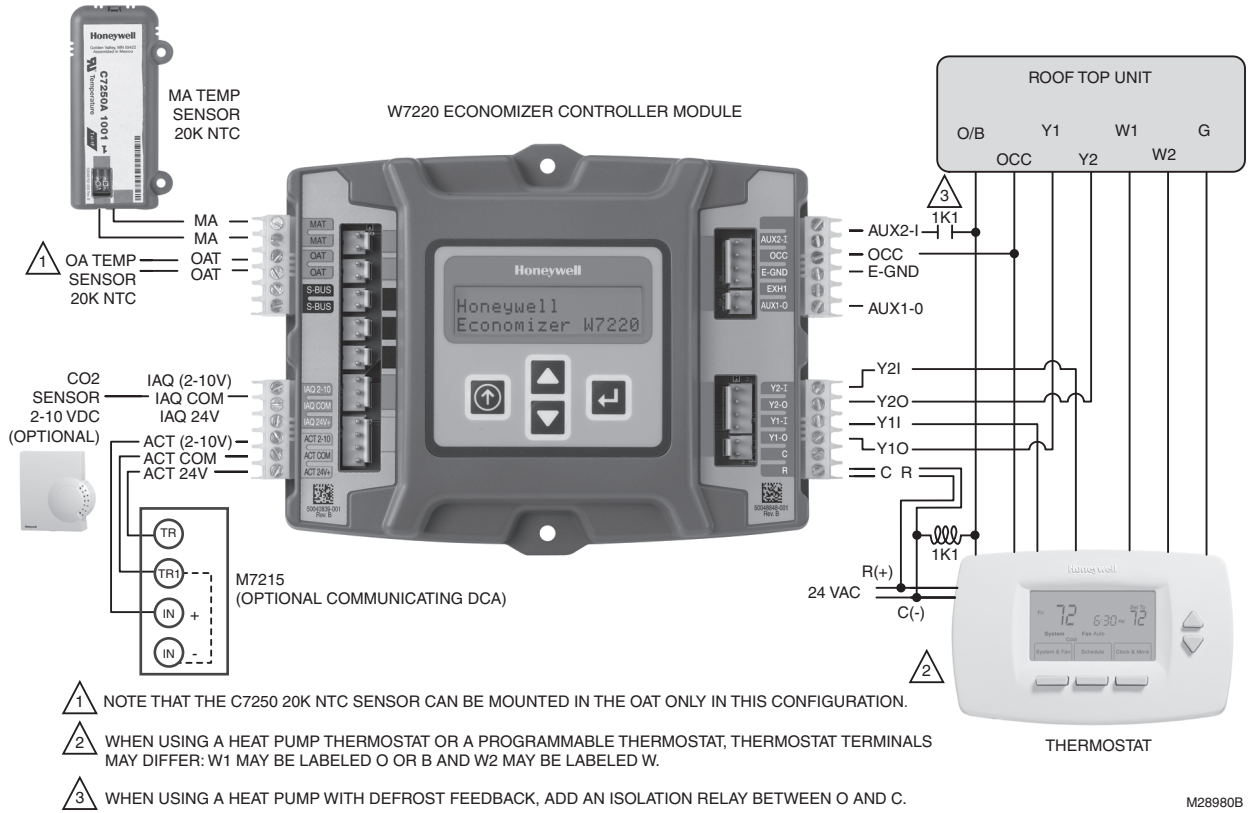
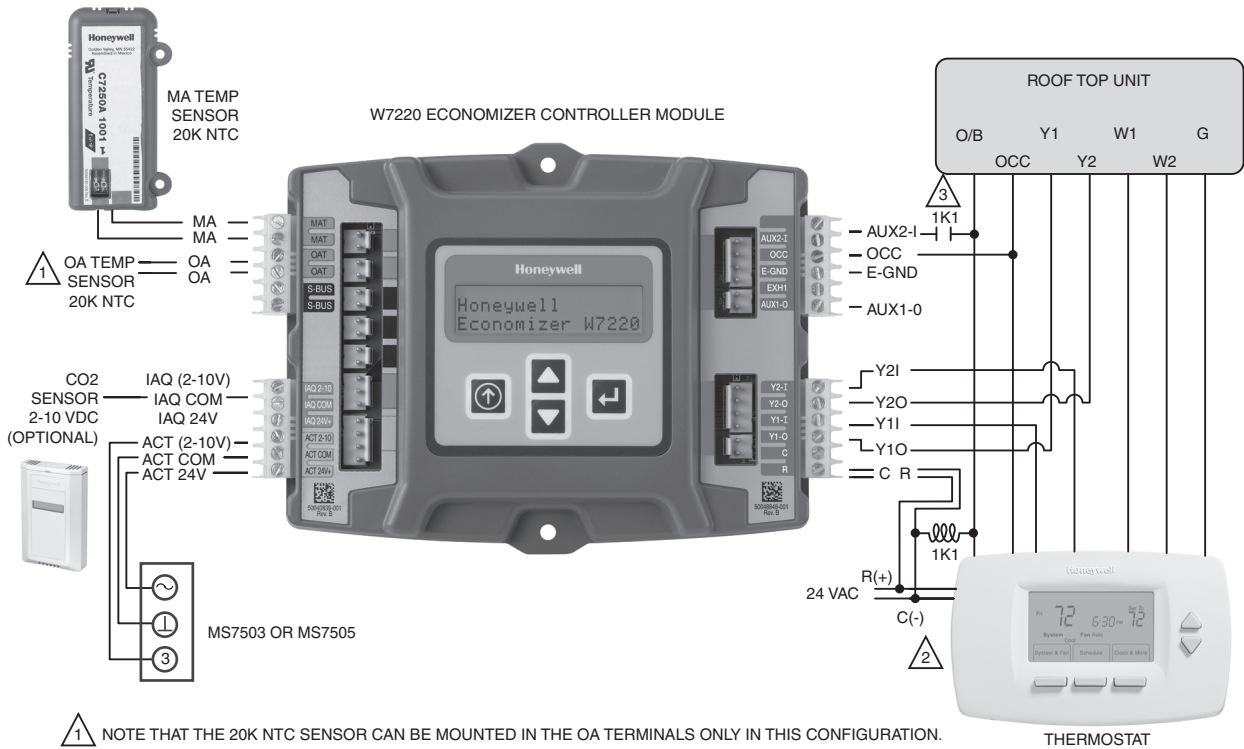

Fig. 1. Stand-alone dry bulb Economizer configuration with black motor M7215.

JADE™ ECONOMIZER MODULE



- 1 NOTE THAT THE 20K NTC SENSOR CAN BE MOUNTED IN THE OA TERMINALS ONLY IN THIS CONFIGURATION.
- 2 WHEN USING A HEAT PUMP THERMOSTAT OR A PROGRAMMABLE THERMOSTAT, THERMOSTAT TERMINALS MAY DIFFER: W1 MAY BE LABELED O OR B AND W2 MAY BE LABELED W.
- 3 WHEN USING A HEAT PUMP WITH DEFROST FEEDBACK, ADD AN ISOLATION RELAY BETWEEN O AND C.

M32564B

Fig. 2. Stand-alone dry-bulb Economizer configuration with Honeywell MS7403 Direct Coupled Actuator.

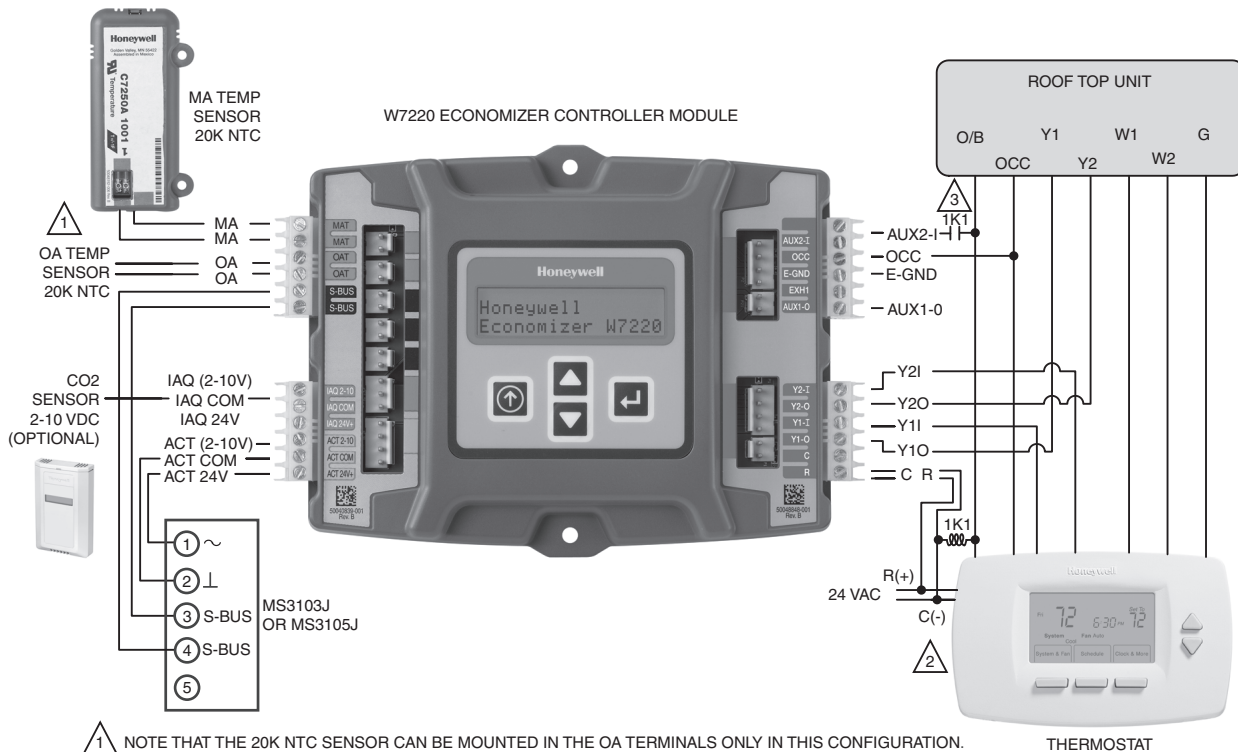

- 1 NOTE THAT THE 20K NTC SENSOR CAN BE MOUNTED IN THE OA TERMINALS ONLY IN THIS CONFIGURATION.
- 2 WHEN USING A HEAT PUMP THERMOSTAT OR A PROGRAMMABLE THERMOSTAT, THERMOSTAT TERMINALS MAY DIFFER: W1 MAY BE LABELED O OR B AND W2 MAY BE LABELED W.
- 3 WHEN USING A HEAT PUMP WITH DEFROST FEEDBACK, ADD AN ISOLATION RELAY BETWEEN O AND C.

M32650B

Fig. 3. Stand-alone dry-bulb Economizer configuration with Honeywell MS3103J or MS3105J communicating actuators.

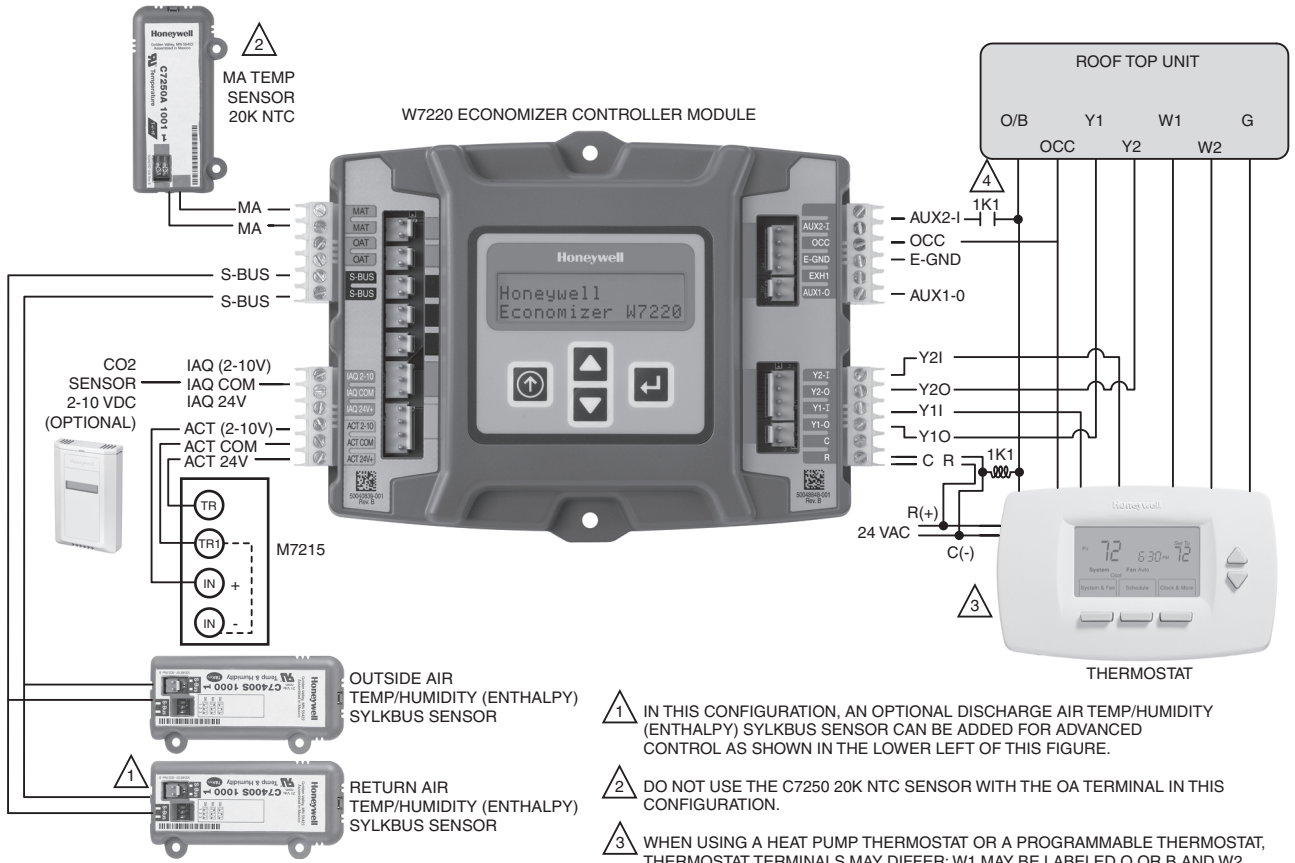

- ⚠️ 1 IN THIS CONFIGURATION, AN OPTIONAL DISCHARGE AIR TEMP/HUMIDITY (ENTHALPY) SYLKBUS SENSOR CAN BE ADDED FOR ADVANCED CONTROL AS SHOWN IN THE LOWER LEFT OF THIS FIGURE.
- ⚠️ 2 DO NOT USE THE C7250 20K NTC SENSOR WITH THE OA TERMINAL IN THIS CONFIGURATION.
- ⚠️ 3 WHEN USING A HEAT PUMP THERMOSTAT OR A PROGRAMMABLE THERMOSTAT, THERMOSTAT TERMINALS MAY DIFFER: W1 MAY BE LABELED O OR B AND W2 MAY BE LABELED W.
- ⚠️ 4 WHEN USING A HEAT PUMP WITH DEFROST FEEDBACK, ADD AN ISOLATION RELAY BETWEEN O AND C.

M32565B

Fig. 4. Economizer with Sylk Bus sensors for enthalpy configuration with Honeywell M7215 black motor.

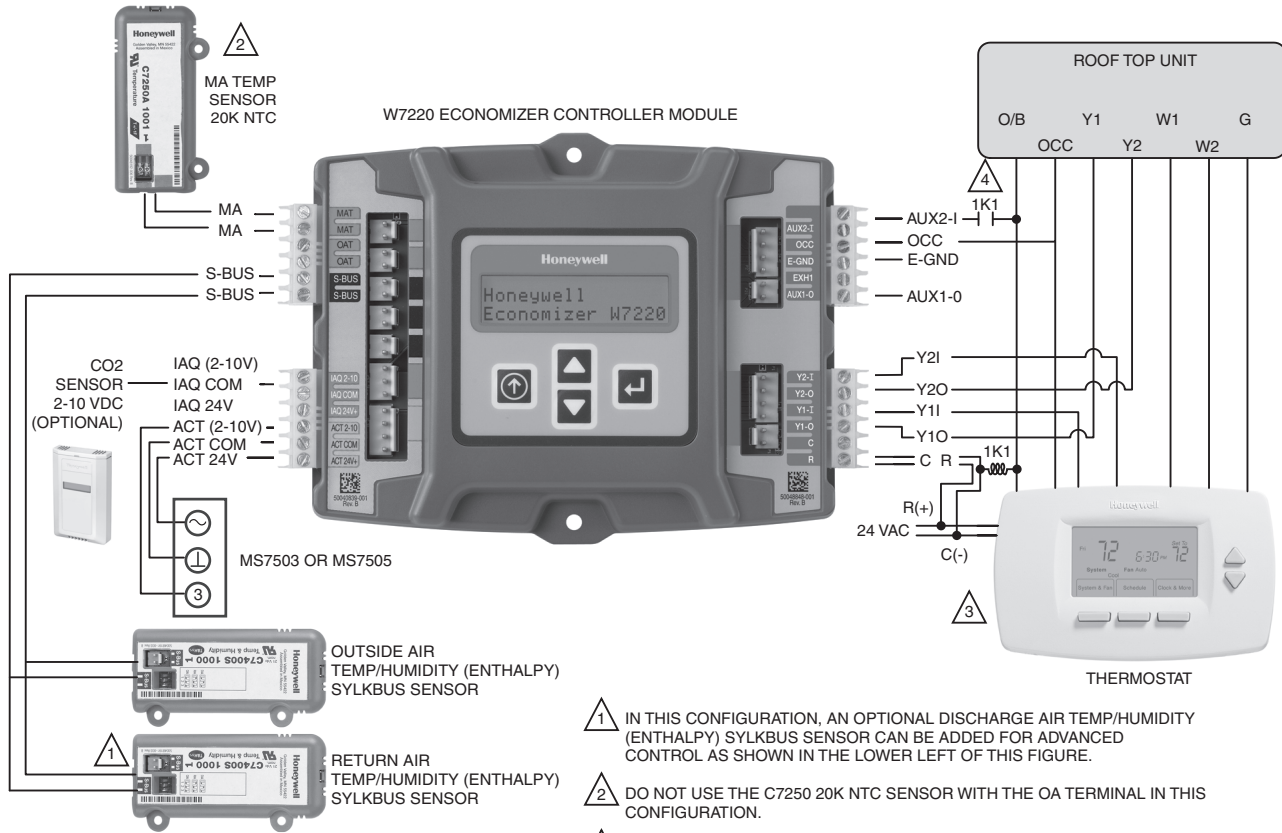

M32566B

Fig. 5. Economizer with Sylk Bus sensors for enthalpy configuration with a Honeywell MS7505 or MS7503 Direct Coupled Actuator.

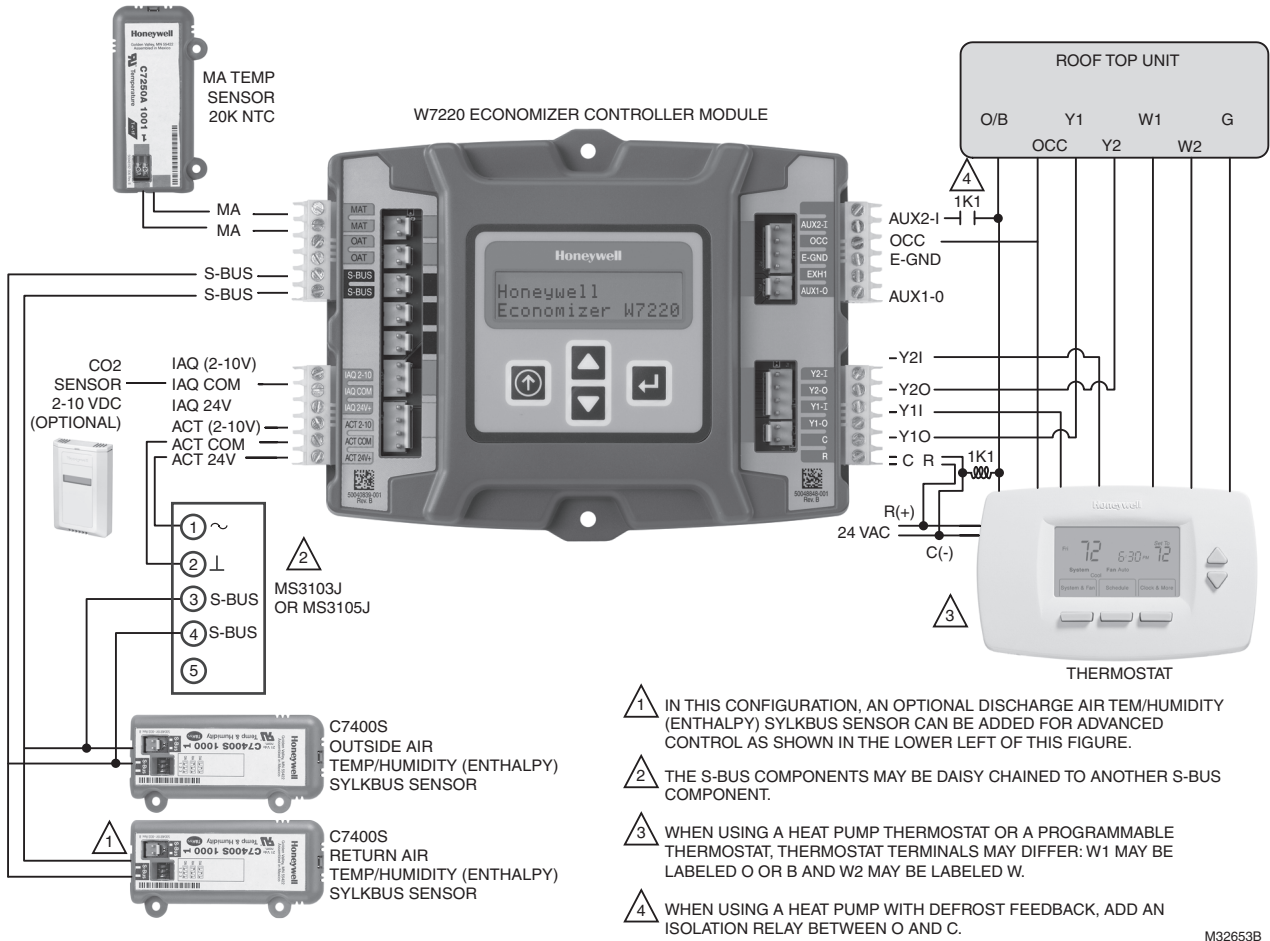
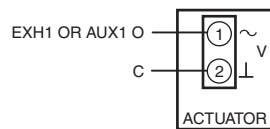

Fig. 6. Economizer with Sylk bus sensor for enthalpy configuration with Honeywell MS3103 or MS3105 communicating actuators.



NOTE: ON/OFF ACTUATORS CAN BE USED ON THE EXH1 OR AUX1 O TERMINAL WITH GROUND TO THE C TERMINAL. WHEN PROGRAMMING THE EXH1 OR AUX1 O, THE % IS THE PERCENT OPEN POSITION OF THE OUTDOOR AIR DAMPER WHEN THE EXH1 OR AUX1 O TERMINAL IS ENERGIZED AND THE 2-POS DAMPER GOES OPEN. IF USING THE AUX1 O TERMINAL PROGRAM AUX1 O FOR EXH2.

M33409

Fig. 7. 2-position actuator.

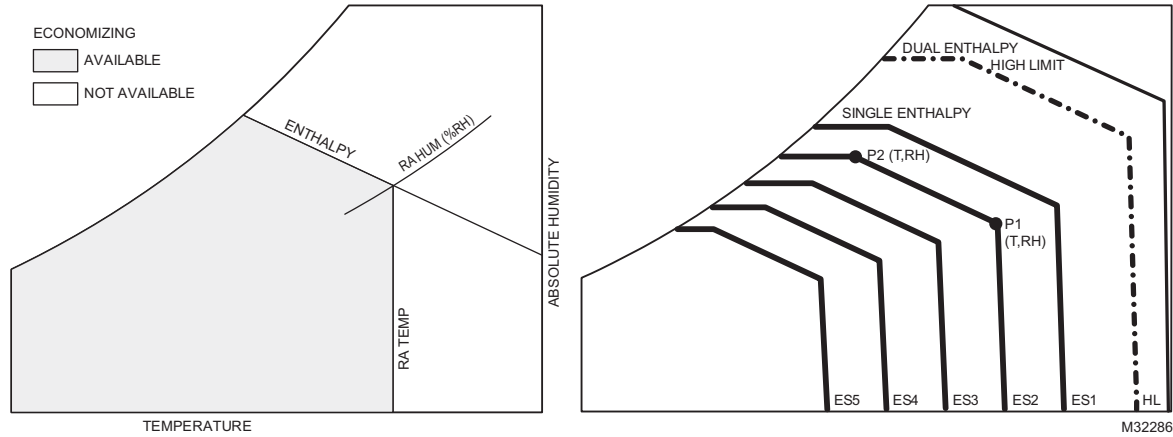

Fig. 8. Single Enthalpy curves and boundaries.

Table 1. Single Enthalpy and Dual Enthalpy High Limit Curves.

Enthalpy Curve	Temp. Dry-Bulb (°F)	Temp. Dewpoint (°F)	Enthalpy (btu/lb/da)	Point P1		Point P2	
				Temp. °F	Humidity %RH	Temp. °F	Humidity %RH
ES1	80.0	60.0	28.0	80.0	36.8	66.3	80.1
ES2	75.0	57.0	26.0	75.0	39.6	63.3	80.0
ES3	70.0	54.0	24.0	70.0	42.3	59.7	81.4
ES4	65.0	51.0	22.0	65.0	44.8	55.7	84.2
ES5	60.0	48.0	20.0	60.0	46.9	51.3	88.5
HL	86.0	66.0	32.4	86.0	38.9	72.4	80.3

Power Up

After the module is mounted and wired, apply power.

Power Up Delay

Upon power up (or after a power outage or brownout), the W7220 controller module begins a 5 minute power up delay before enabling mechanical cooling.

Initial Menu Display

On initial start up, **Honeywell** displays on the first line and **Economizer W7220** on the second line. After a brief pause, the revision of the software appears on the first line and the second line will be blank.

Power Loss (Outage or Brownout)

All setpoints and advanced settings are restored^a after any power loss or interruption.

NOTE: If power goes below 18 Vac, the W7220 controller module assumes a power loss and the 5 minute power up delay will become functional when power returns above 18 Vac.

TROUBLESHOOTING

Alarms

The Economizer module provides alarm messages that display on the 2-line LCD.

NOTE: Upon power up, the module waits several seconds before checking for alarms. This allows time for all the configured devices (e.g. sensors, actuator) to become operational. If one or more alarms are present and there has been no keypad activity for at least 5 minutes, the Alarms menu displays and cycles through the active alarms.

You can also navigate to the Alarms menu at any time.

^a All settings are stored in non-volatile flash memory.

Table 2. Alarms Menu.

Menu	Alarm
ALARMS()	MA T SENS ERR
	CO2 SENS ERR
	OA T SENS ERR
	DA ENTHL ERR
	SYS ALARM ^a
	ACT Over Voltage ^b
	ACT Under Voltage ^b
ACT Stalled ^b	
NOTES: 1. The Alarms menu displays only when alarm(s) are active and includes the number of active alarms in parenthesis (). 2. The alarms listed are a few examples. Additional alarms display depending on the parameter settings and configuration.	

^a When AUX1 O is set to SYS and there is any alarm (e.g., failed sensors, etc.), the AUX1 O terminal has 24 Vac out and the LCD displays the ALARM.

^b This alarm is only displayed when a communicating actuator is used. (ex: MS3105AJ)

Clearing Alarms

Once the alarm has been identified and the cause has been removed (e.g. replaced faulty sensor), the alarm can be cleared from the display.

To clear an alarm, perform the following:

1. Navigate to the desired alarm.
2. Press the ↵ button.
3. ERASE? displays.
4. Press the ↵ button.
5. ALARM ERASED displays.
6. Press the ⬆ button (MenuUp/Exit) to complete the action and return to the previous menu.

NOTE: If an alarm still exists after you clear it, it re-displays within 5 seconds.

NOTE: Jade will be in the "set up" mode for the first 60 minutes after powered. If a sensor for OA air or Sylkbus device (sensor, actuator) is disconnected during the set up mode, the Jade will not alarm that failure. The MA sensor is a system "critical" sensor; if the MA sensor is removed during the set up mode, the Jade will alarm. After 60 minutes the Jade controller will change to operation mode and all components removed or failed will alarm in the operation mode.

COMMON INSTALLATION ISSUES AND CONCERNS

Table 3. Installation Issues and Concerns.

Area	Issue or Concern	Possible Cause and Remedy
Configuration	Are the old sensors in the unit (C7400A, C7150 or C7232) compatible with the economizer controller?	No, the C7400A and C7150 sensors are not compatible with the W7220. The enthalpy sensor for the W7220 is the C7400S. The Mixed Air or Outdoor air dry bulb sensors are the C7250A. The C7232 CO ₂ sensor is compatible with the W7220.
	The unit has a W7459 economizer and black motor. Do I need to change the motor?	If you have a W7459 economizer with a M7415 motor you will need to change to a M7215 motor. The W7220 has a 2 to 10 Vdc out to the motor, so you will need a M7215 motor. The M7215 motors are used with the W7212 economizers. So if you have one of these units, you will not have to change the motor.
Wiring	I have 4 terminals on my actuator and the wiring only shows 3 wires.	The economizer 24 Vac COM can be wired to the Honeywell actuator common (<u> </u> or TR1). The actuators have internal ground circuits.
	There is an Earth Ground terminal. Do I need to wire to earth ground?	Yes, the economizer must be wired to earth ground.
	What are the part numbers of the 2 and 6 pin side connectors?	The 2-pin connectors are Honeywell part number 50048926-001 and the 6-pin connectors are Honeywell part number 50048926-002. Both are available in accessory bags of 20 each.

Table 3. Installation Issues and Concerns. (Continued)

Area	Issue or Concern	Possible Cause and Remedy
Operation or Use	My outdoor temperature reading on the STATUS menu is not accurate.	Check the sensor wiring. Enthalpy sensors are to be wired to the Syk Bus terminals. Temperature sensors are to be wired to the OAT and MAT terminals.
	If my enthalpy sensor drifts in accuracy over time, can I re-calibrate it?	The sensors are not able to be re-calibrated in the field. However there is a menu item under the ADVANCED menu where you are able to input a limited offset in temperature and humidity for each sensor you have connected to the economizer.
	Can I go back to factory defaults and start over?	Under the SYSTEM SETUP menu you can change the setpoints to the factory defaults.
	Will I be able to see the LCD screen when it is in the unit?	The LCD screen has a backlight that is always illuminated.
	What is a good setpoint for the Mixed Air Temperature (MAT)?	The mixed air temperature is the temperature of air that you want to supply to the space. In a commercial building, this is between 50 to 55°F (10 to 13°C). The mixed air is the mixing of the return air and the outdoor air.
	I am using enthalpy sensors. Why did the control ask me to input a dry bulb changeover temperature?	In the event the humidity sensor in the enthalpy sensors fails, the backup algorithm in the control is to default to the temperature sensor in the enthalpy sensor.
	In checkout, the outdoor damper closes when I command it open.	Check the actuator linkage or rotation. In the CHECKOUT mode, the outdoor damper should drive open or closed with the return air damper having the opposite effect.
	How do I set my minimum position?	The minimum position is set using the VENTMIN and VENTMAX setup in the SETPOINTS menu. VENTMIN is the minimum ventilation required when using an occupancy sensor and VENTMAX is the minimum ventilation when not using an occupancy sensor for Demand Control Ventilation. The VENTMAX position is set the same as with the potentiometer on the analog economizers and is the output voltage to the damper actuator. The range is 2 Vdc closed OA damper and 10 Vdc open OA damper.
	What if my damper does not go completely closed in the checkout operation?	Check the damper linkage or hub to make sure the damper is able to close completely.
	How do I set the OCC?	There are two settings for the OCC setting, INPUT and ALWAYS. INPUT is from the space thermostat, if it has an occupancy output. ALWAYS is the unit in the occupied mode, if the economizer is powered (fan on).
	Does the economizer save my program values if the unit loses power?	Yes, once the changes are stored in the controller they will be stored until they are changed by the operator.
	If the unit is left in checkout, how long will the unit stay in checkout mode without input?	The unit will remain in checkout for 10 minutes, then return to normal operation.

Automation and Control Solutions

Honeywell International Inc.
1985 Douglas Drive North
Golden Valley, MN 55422
customer.honeywell.com

© U.S. Registered Trademark
© 2012 Honeywell International Inc.
62-0331—07 M.S. Rev. 02-12
Printed in United States

Honeywell

Free Manuals Download Website

<http://myh66.com>

<http://usermanuals.us>

<http://www.somanuals.com>

<http://www.4manuals.cc>

<http://www.manual-lib.com>

<http://www.404manual.com>

<http://www.luxmanual.com>

<http://aubethermostatmanual.com>

Golf course search by state

<http://golfingnear.com>

Email search by domain

<http://emailbydomain.com>

Auto manuals search

<http://auto.somanuals.com>

TV manuals search

<http://tv.somanuals.com>