



BY APPOINTMENT TO
HER MAJESTY QUEEN ELIZABETH II
MANUFACTURERS OF DABLER AND JAGUAR CARS
JAGUAR CARS LIMITED COVENTRY



BY APPOINTMENT TO
HER MAJESTY QUEEN ELIZABETH
THE QUEEN MOTHER
MANUFACTURERS OF DABLER AND JAGUAR CARS
JAGUAR CARS LIMITED COVENTRY



BY APPOINTMENT TO
HIS ROYAL HIGHNESS THE PRINCE OF WALES
MANUFACTURERS OF DABLER AND JAGUAR CARS
JAGUAR CARS LIMITED COVENTRY

BLUETOOTH[®] IN-CAR TELEPHONE HANDBOOK

Publication Part No. **JJM 10 31 99 552**

Published June 2005 by Technical Communications, **Jaguar Cars Limited**

JAGUAR CARS LIMITED, as manufacturer, is dedicated to the design and production of vehicles which meet the expectations of the world's most discerning purchasers.

This handbook forms part of the owner literature supplied with your vehicle. It is designed to complement the relevant features and systems of the vehicle, and make them easy to understand and operate. For safety and the pleasure you will get from your new vehicle, please take the time to get well acquainted with your vehicle by reading the handbooks.

This handbook describes every option and model variant available and therefore, some of the items covered may not apply to your particular vehicle.

For the specification of a particular vehicle, owners should consult their Jaguar Dealer/Authorised Repairer.

To cover changes, it is sometimes necessary to issue one or more handbook supplements. When reading this handbook, check the owner literature for possible supplements. Any further updates will be posted on the Jaguar Cars internet site and can be accessed at www.jaguar.com in the **Owner Information** area.

For full details of the owner literature originally supplied with the vehicle, owners should consult their Jaguar Dealer/Authorised Repairer.

When left-hand or right-hand is used in the text, this refers to the left-hand side or right-hand side of the vehicle, when viewed from the rear.

The manufacturer reserves the right to vary its specifications with or without notice, and at such times and in such manner as it thinks fit. Major as well as minor changes may be involved in accordance with the Manufacturer's policy of constant product improvement.

All rights reserved. No part of this publication may be reproduced, stored in a retrieval system or transmitted, in any form, electronic, mechanical, photocopying, recording or other means without prior written permission from the Service Division of Jaguar Cars Limited.



This book is printed on paper that originates from sustainable forests, is recyclable, bio-degradable and acid-free. The wood pulp is chlorine-free and the effluent water is purified before being discharged.

Contents

Quick Overview	6
Introduction	15
Safety	17
Audio Panel Controls	19
Getting Started	21
Phone Book	25
Hands-free Controls	27
Hands-free Operation	31
Touch-screen Controls	34
Voice Activation	38
Declaration of Conformity ..	39

A comprehensive index is located at the back of this handbook.

L

Quick Overview

Quick Overview

INTRODUCTION	6
TOUCH-SCREEN SYSTEM	6
AUDIO SYSTEM	10

Quick Overview

INTRODUCTION

Bluetooth communication operates between bluetooth equipped devices; in this case, the Jaguar Touch-screen System or Audio System and a mobile phone.

There are a limited number of mobile phones (currently ten) that have been tested and proved to function correctly with the Jaguar system - ask your Jaguar Dealer for details.

Before any phone can operate with the Jaguar system, it must be Paired with the system.

This involves the phone and the Jaguar system communicating a unique code between them, at initiation, so that in future they each recognise one another.

When Pairing any phone with the Jaguar system make sure that the phone is switched on, the phone battery is fully charged and the User's Handbook for the phone is available.

This Quick Overview describes the Touch-screen System first (**Page 6**), followed by the Audio System display (**Page 10**).

The Bluetooth system is identical for both the Touch-screen and the Audio displays, the difference is only in the way that the information is presented to the user.

TOUCH-SCREEN SYSTEM

Icons and buttons used in the following Touch-screen instructions:



Phone Mode button, to manually select the phone mode. Located to the left of the Touch-screen.



Send/End icon. Located on the Touch-screen.

Switching ON the ignition

Each time the ignition is switched on, the following screens may be displayed.

HANDSET IN USE

Mute and replace handset to continue hands free call, or replace handset to end call.

JOL3915

This screen may be displayed for a few seconds while the system is performing a self-check.

Do not take any action. However, should the screen stay on for longer than twenty seconds, switch the ignition **OFF** and wait for at least 6 minutes. Refer to **Reason for Ignition OFF for 6 Minutes, page 8** for more information.

After the brief system check, you should see the following screen:

Quick Overview

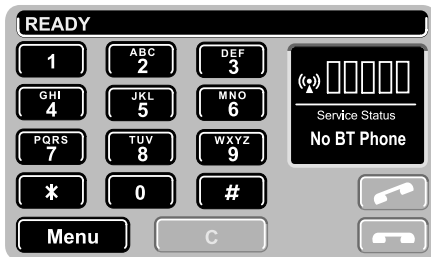

JOL3916

This screen will be displayed to indicate one of two possible conditions:

1. There is no phone currently Paired to the vehicle system or no phone is available. Should this be the case, this screen will continue to be displayed while the system is in phone mode (the system may display the **Discover Me** screen ready for you to Pair your Bluetooth mobile phone).
2. Displayed only for a few seconds if a phone IS Paired, but whilst the system is booting-up and looking for a Paired device. If the last Paired phone is available and switched on in Bluetooth mode, then the screen changes from **No BT Phone** to **Phone Connected**.

Pairing your phone

The following instructions describe how to initiate Pairing your mobile phone to the Jaguar system.

If there is no mobile phone Paired to the vehicle system and the **No BT Phone** screen is displayed, Pairing may be performed as follows:

Select Phone Mode (if not already selected).

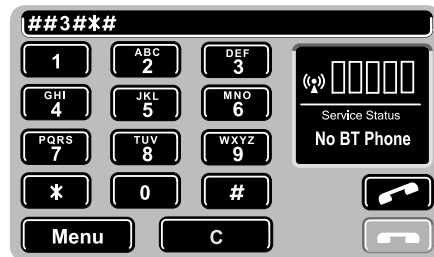

JOL3917

Use the touch-screen keypad to enter the following digit sequence and press the green Send/End icon.

##3##

The display will then show the following screen.

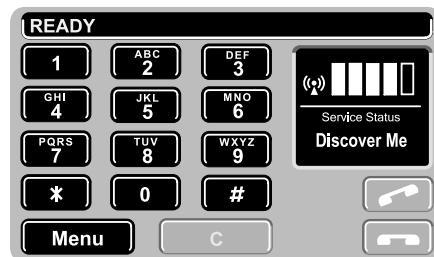

JOL3919

At the **Discover Me** screen the vehicle system is waiting for communication with a Bluetooth equipped telephone.

Check that your mobile phone is set to the Jaguar Bluetooth system, using the menu functions on the phone. Refer to the handbook that was supplied with your specific mobile phone.

When **Jaguar** device is found on the mobile phone display, the phone will prompt you to enter the pass key (1313) on the mobile phone keypad.

Quick Overview

When the above operation has been completed and the phone is successfully Paired and connected with the vehicle system, the **Phone Connected** screen will be displayed.



JOL3920

Note: The screen may briefly change from **Discover Me to No BT Phone** whilst the system connects the Bluetooth link, before the **Phone Connected** screen is displayed.

Downloading your phonebook entries

The Phonebook entries on your mobile phone can be downloaded from your phone to the vehicle system, dependent on the capability of the mobile phone.

For more information, refer to the specific Quick Guide (available from your Jaguar Dealer or Authorised Repairer) for your phone.

The following process will only work with specific phones. The phone must be ON and already Paired with the Jaguar system.

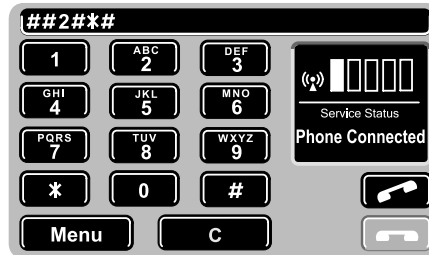

JOL3948

1. Press the vehicle Phone Mode button. (If not already in phone mode.)
2. Use the touch-screen keypad to enter the key sequence **##2*##**, followed by the green, Send/End icon on the screen.
3. To use or access your phonebook immediately after Pairing:
Switch **OFF** the ignition for 6 minutes, to allow the vehicle Bluetooth system to complete the download process.
4. Switch **ON** the ignition.

The download should now have completed successfully.

Note: Should you not wish to switch off the ignition for 6 minutes at this time, the phone book will be displayed after the next normal ignition off cycle that elapses for that duration.

Reason for Ignition OFF for 6 Minutes

The Bluetooth phone module in the vehicle remains active for 6 minutes after the ignition has been switched off.

It is important to wait this 6 minutes so that a clean boot-up of the Bluetooth module is achieved and the correct information is stored.

Quick Overview

Once a phone has been Paired with the vehicle system, it will not need to be done again unless the vehicle battery is disconnected, or possibly if the system closes down for security reasons, or if you choose to Pair a different phone with the system - only one phone at any time can be Paired with the system.

To pair a different phone with the system

If you attempt to Pair a different phone immediately after switching ON the ignition and the last Paired phone is NOT available, you will have 2 minutes within which to enter the digit sequence **##3##** to put the system into **Discover Me** mode.

This is because, when the ignition is switched ON, the system is looking for the last Paired phone and if it does not find it the system will revert to the **Handset in Use** screen.

To Pair a different phone, select Phone Mode and use the keypad to enter the following digit sequence **##3##**.

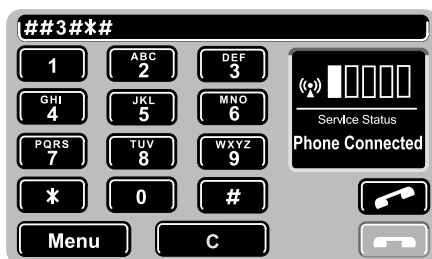

JOL3918

Press the green Send/End icon to initiate the Pairing process again and to overwrite the previously Paired phone.

Then, refer to **Page 7** at the **Discover Me** screen.

If the screen displays - Registered

If the ignition is switched to Accessory or to the ON position for a short period of time, then switched OFF and ON again, the message displayed subsequently may change to **Registered** (instead of Discover Me or No BT Phone or Phone Connected).

This is not due to a fault. It is because the system has sensed an incorrect shut-down of the Bluetooth module - that is, it has not been allowed to follow its normal closing down procedure time of 6 minutes.



However, the state of the five bars still indicates the correct (current) status of the system. You can still Pair a phone to the system and use the system as normal.

When the system changes from one mode to another (for example, Discover Me to Phone connected) the Registered message will disappear.

Quick Overview

AUDIO SYSTEM

The buttons used in the following Audio System instructions:

-  Phone Mode button, to manually select the phone mode. Located to the left of the Audio panel display.
-  Send/End button. Located to the left of the Audio panel display.

Switching ON the ignition

Each time the ignition is switched on, the following screens may be displayed.

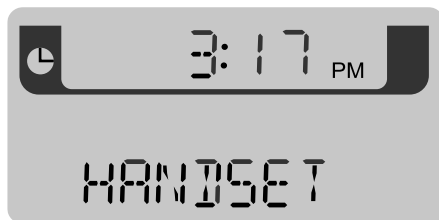

JOL3921

This screen may be displayed for a few seconds while the system is performing a self-check.

Do not take any action. However, should the screen stay on for longer than twenty seconds, switch the ignition **OFF** and wait for at least 6 minutes. Refer to **Reason for Ignition OFF for 6 Minutes, page 12** for more information.

After the brief system check, you should see the following screen:

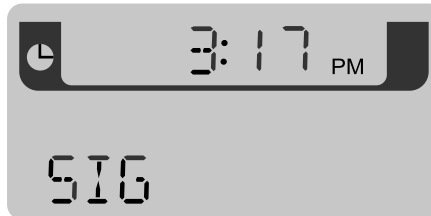

JOL3922

This screen will be displayed to indicate one of two possible conditions:

1. There is no phone currently Paired to the vehicle system or no phone is available. Should this be the case, this screen will continue to be displayed while the system is in phone mode (the system may display the **SIG****** or **SIG******* screen ready for you to Pair your Bluetooth mobile phone).
2. Displayed only for a few seconds if a phone IS Paired, but whilst the system is booting-up and looking for a Paired device. If the last Paired phone is available and switched on in Bluetooth mode, then the screen changes from **SIG** to **SIG***.

Quick Overview

Pairing your phone

The following instructions describe how to initiate Pairing your mobile phone to the Jaguar system.

If there is no mobile phone Paired to the vehicle system and the **SIG** screen is displayed, Pairing may be performed as follows:

Select Phone Mode (if not already selected).

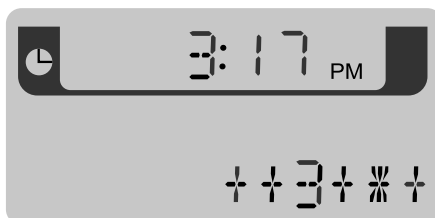

JOL3925

Use touch-screen keypad to enter the following digit sequence and press the Send/End button.

##3##

The display will then show the following screen.

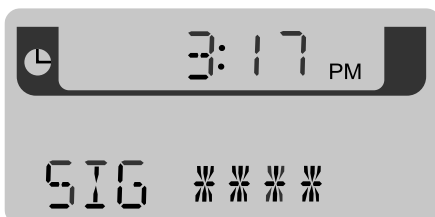

JOL3923

At the **SIG****** screen the vehicle system is waiting for communication with a Bluetooth equipped telephone.

Check that your mobile phone is set to the Jaguar Bluetooth system, using the menu functions on the phone. Refer to the handbook that was supplied with your specific mobile phone.

When **Jaguar** device is found on the mobile phone display, the phone will prompt you to enter the pass key (1313) on the mobile phone keypad.

When the above operation has been completed and the phone is successfully Paired and connected with the vehicle system, the **SIG*** screen will be displayed.

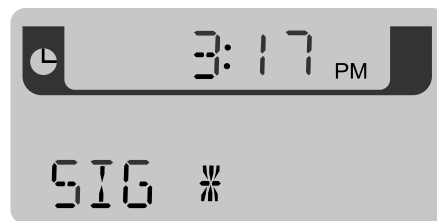

JOL3924

Note: The screen may briefly change from **SIG****** to **SIG** whilst the system connects the Bluetooth link, before the **SIG*** screen is displayed.

Quick Overview

Downloading your phonebook entries

The Phonebook entries on your mobile phone can be downloaded from your phone to the vehicle system, dependent on the capability of the mobile phone.

For more information, refer to the specific Quick Guide (available from your Jaguar Dealer or Authorised Repairer) for your phone.

The following process will only work with specific phones. The phone must be ON and already Paired with the Jaguar system.

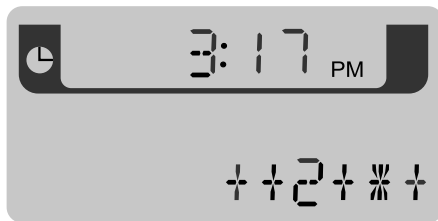

JOL3943

1. Press the vehicle phone mode button. (If not already in Phone Mode.)
2. Use the Audio panel keypad to enter the key sequence **##2##**, followed by pressing the Send/End button.
3. To use or access your phonebook immediately after Pairing:
Switch **OFF** the ignition for 6 minutes, to allow the vehicle Bluetooth system to complete the download process.
4. Switch **ON** the ignition.

The download should now have completed successfully.

Note: Should you not wish to switch off the ignition for 6 minutes at this time, the phone book will be displayed after the next normal ignition off cycle that elapses for that duration.

Reason for Ignition OFF for 6 Minutes

The Bluetooth phone module in the vehicle remains active for 6 minutes after the ignition has been switched off.

It is important to wait this 6 minutes so that a clean boot-up of the Bluetooth module is achieved and the correct information is stored.

Once a phone has been Paired with the vehicle system, it will not need to be done again unless the vehicle battery is disconnected, or possibly if the system closes down for security reasons, or if you choose to Pair a different phone with the system - only one phone at any time can be Paired with the system.

Quick Overview

To pair a different phone with the system

If you attempt to Pair a different phone immediately after switching ON the ignition and the last Paired phone is NOT available, you will have 2 minutes within which to enter the digit sequence **##3##** to put the system into **SIG****** mode.

This is because, when the ignition is switched ON, the system is looking for the last Paired phone and if it does not find it the system will revert to the **Handset** screen and drop out of Phone Mode.

To Pair a different phone, select Phone Mode and use the keypad to enter the following digit sequence **##3##**.

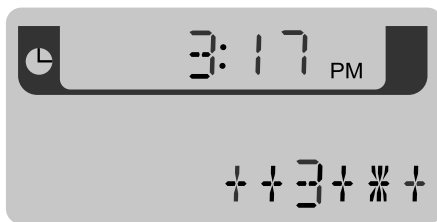

JOL3925

Press the Send/End button to initiate the Pairing process again and to overwrite the previously Paired phone.

Then, refer to **Page 11** at the **SIG****** screen.

L

Introduction

WHAT IS BLUETOOTH?

Bluetooth is an international standard that allows electronic components to communicate with each other, using a short-range radio link. Bluetooth eliminates the need for wires or cables: typically, devices can communicate at a range of up to 10 metres (33 feet).

The Bluetooth in-car telephone system allows certain mobile phones to be used hands free in your vehicle: there is no need to connect the mobile phone to a cradle or cable.

Bluetooth is a registered trademark of Bluetooth SIG, Inc.

SYSTEM OVERVIEW

The vehicle's Bluetooth telephone system can be used with an appropriate, Bluetooth-equipped mobile phone.

The mobile phone must be paired with the vehicle system before use. See page 21 for more information.

Once paired, the mobile phone can be operated via the steering wheel switches or the keypad and phone buttons on the audio panel or touch-screen. The mobile phone doesn't need to be physically connected to the vehicle: it can be left in a jacket pocket, for instance. Calls are routed through the vehicle's audio speakers, and a dedicated microphone is fitted to the roof lining, near the driver's head.

You can use the system to answer or reject incoming calls, make outgoing calls or alter the call volume. The system does not support SMS text messages.

Note: *The vehicle ignition must be set to position I or II in order to use the phone.*

Call volume

The volume of telephone calls can be adjusted for hands-free phone operation. To adjust the volume, operate the audio system's ON/OFF volume control during a phone call.

If the audio system is in use when the phone becomes active, the audio system source is suppressed for the duration of the call.

The Jaguar telephone system is designed to function with a wide variety of Bluetooth-equipped mobile phones. The audio and echo characteristics vary between models of mobile phones: as a result, it may take a few seconds for the vehicle system to adapt to provide optimal audio performance.

In order to achieve the best possible audio performance, it may be necessary to reduce the system volume slightly when using certain mobile phones.

Audio panel display

Phone related messages are shown on the audio panel display or touch-screen (where fitted) when the phone system is active.

Introduction

ABOUT THIS HANDBOOK

Take particular note of the following symbols used throughout this manual:

Note: *A note contains additional information which is relevant to the feature/item.*

Caution: **A caution contains important additional information that is relevant to the efficient and/or safe usage of the telephone system.**



WARNING:

A warning is a procedure which must be followed precisely to help avoid the risk of personal injury.

VOICE ACTIVATION

(Where fitted)

The Bluetooth telephone system can be used in conjunction with the Voice Activation System to provide the driver with completely hands-free communication. Voice commands are picked up by the system microphone.

For information about using voice activation, refer to the audio systems and JaguarVoice handbook, or the touch-screen display handbook.



WARNING:

The voice activation system must not be used to call emergency numbers, as voice patterns can change under stress, resulting in commands becoming unrecognisable.

Safety

SAFETY



WARNING:

Read this information before using your in-car telephone system.

Driving

Check local regulations on the use of telephones in the areas where you drive and always obey them. Observe the following guidelines when using your phone while driving:

- Give full attention to driving - safe driving is your first responsibility.
- Always use hands-free operation when driving.
- When receiving a call, if driving conditions demand, pull off the road and park.

Electronic devices

Most modern electronic equipment is shielded from RF signals.

However, certain equipment may not be shielded against RF signals from your telephone.

Pacemakers

The Health Industry Manufacturers Association recommends that a minimum separation of 15 centimetres (6 inches) is maintained between a wireless phone antenna and a pacemaker to avoid potential interference with the pacemaker. These recommendations are consistent with the independent research by and recommendations of Wireless Technology Research.

Persons with pacemakers should:

- Preferably use the vehicle hands-free system.
- ALWAYS keep the phone more than 15 centimetres (6 inches) from their pacemaker when the phone is switched ON.
- Turn the phone OFF immediately if there is any reason to suspect that interference is taking place.

Other medical devices

If you use any other personal medical device, consult the manufacturer of your device, or your doctor, to determine that it is adequately shielded from external RF energy.

Turn your phone OFF in health care facilities when any regulations posted in such areas instruct you to do so. Hospitals or health care facilities may be using equipment that could be sensitive to external RF energy.

Vehicles

RF signals may affect non-Jaguar or improperly installed equipment. Always consult the manufacturer of any equipment that has been retro-fitted to your vehicle.

Posted facilities

Turn your phone OFF in any facility where posted notices so require.

Blasting areas

To avoid interfering with blasting operations, turn your phone OFF when in a blasting area or in areas posted: Turn off two-way radios. Obey all signs and instructions.

Safety

Potentially explosive atmospheres

Areas with a potentially explosive atmosphere are often but not always clearly marked. Turn your phone OFF when you are in such an area, as the use of unapproved electrical equipment can cause an explosion or fire resulting in bodily injury or death.

Airbags

Airbags inflate with great force.



WARNING:

Do NOT place objects, including both installed or portable wireless equipment, in the area over an airbag or in the airbag deployment area. If in-vehicle wireless equipment is improperly installed and the airbag inflates, serious injury could result.

Audio Panel Controls

THE XJ, S-TYPE AND X-TYPE

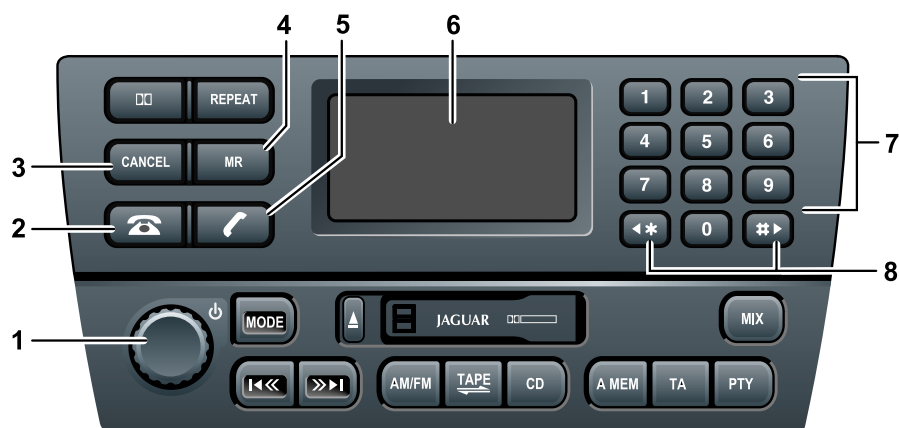

JOL3449

- | | |
|--------------------------------------|--|
| 1. ON/OFF switch and volume control. | 6. Display. |
| 2. Phone mode button. | 7. Phone keypad - buttons 0 to 9 (except where touch-screen is fitted, see page 34). |
| 3. Cancel/correct telephone numbers. | 8. Scroll memory location. |
| 4. Phone memory recall button. | |
| 5. Phone send/end calls | |

Audio Panel Controls

THE XK ONLY

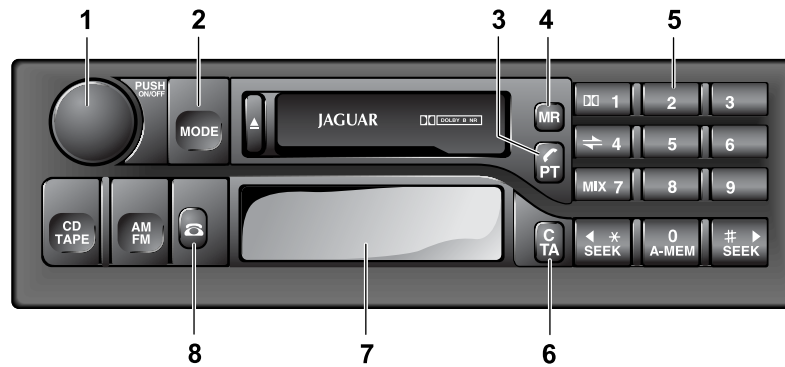

JOL3496

1. ON/OFF switch and volume control.
2. Mode.
3. Phone send/end calls.
4. Phone memory recall button.
5. Phone keypad - buttons 0 to 9.
6. Phone clear.
7. Display.
8. Phone mode button.



Getting Started

PAIRING YOUR PHONE

Before use, your mobile phone must be connected or paired with the vehicle's Bluetooth system.

Vehicles with touch-screen

Follow these steps to pair your phone with the vehicle:

- Switch the vehicle's ignition ON (position II).
- Press the  button, to the left of the touch-screen.
- Using the touch-screen keypad, enter the code **##3##**, then touch .
- The message **Discover Me** will be displayed, to confirm that the system is ready to pair with a mobile phone.
- Switch on your mobile phone's Bluetooth connection, using the phone's menu. (See your phone's manual for more information.)
- Select search for other Bluetooth devices or Audio Accessories from your mobile phone's menu.
- Select Jaguar in your phone's paired device list, in order to connect to the vehicle's Bluetooth system.
- Enter the Passkey on your mobile phone (the Passkey is 1313).
- Under certain circumstances, the message **No BT Phone** may be displayed briefly.
- After a short delay, the message **Phone Connected** will confirm that the phone and vehicle are paired.



Note:

- *Once a mobile phone has been paired with the vehicle, the system will look for the same phone each time the ignition is switched ON. If no phone is detected, the message **No BT Phone** will appear on the touch-screen to confirm that no phone is connected after approximately three minutes.*
- *When a mobile phone is paired to the vehicle and the Bluetooth connection is established, one bar will be displayed next to the antenna icon. However, you will need to refer to your mobile phone's display to determine the strength of the network signal.*
- *If an incorrect Passkey is entered, your mobile phone should prompt you to enter the correct Passkey.*
- *If there is a delay of approximately five minutes when pairing a phone with the vehicle, a screen with the message **Handset In Use** may be displayed. If this occurs, switch the vehicle ignition to OFF and wait for at least five minutes before repeating the pairing procedure.*

Getting Started

Vehicles without touch-screen

Follow these steps to pair your phone with the vehicle:

- Switch the vehicle's ignition ON (position II).
- Press the  button on the audio panel. **SIG** will be displayed.
- Using the audio panel keypad, enter the code **##3##** and press the  button.

It is recommended to use the code **##3##** to pair your phone because this code has no automatic time-out period.

- **SIG****** will be displayed.
- Switch on your mobile phone's Bluetooth connection, using the phone's menu. (Refer to the manual for of your specific phone).
- Select search for other Bluetooth devices or Audio Accessories from your mobile phone's menu.
- Select Jaguar in your phone's paired device list, in order to connect to the vehicle's Bluetooth system.
- Enter the Passkey on your mobile phone (the Passkey is 1313). **SIG** will be displayed initially.
- Once the vehicle and phone are paired, **SIG *** will appear on the audio panel.

Once a mobile phone is paired with the vehicle, **SIG** will be displayed initially when the ignition is switched ON. **SIG*** will then be displayed, once the phone is detected.

If the phone is not detected within two minutes (after switching ON the ignition), the audio system will exit phone mode and revert to its previous audio mode.

Note:

- *Once a mobile phone is paired with the vehicle, **SIG****** will be displayed initially when the ignition is switched ON. If no phone is detected, the message **SIG** will confirm that no phone is connected after approximately two minutes.*
- *If an incorrect Passkey is entered, your mobile phone should prompt you to enter the correct Passkey.*

Getting Started

All vehicles

Once a mobile phone is paired with the vehicle, the vehicle will look for this specific phone every time the ignition is switched ON.

Pairing other phones



Only one mobile phone can be paired with the vehicle at a time. Once paired, the vehicle will look for the same phone each time the ignition is switched ON (position II): you do not need to manually pair the phone with the vehicle every time you switch the ignition ON.

The Bluetooth function of your mobile phone must be switched on when the ignition is switched ON in order for it to pair with the vehicle automatically.

If a different Bluetooth mobile phone is to be used with the vehicle, it must be paired manually, as described previously. This phone will then become the default phone, which the system will look for each time the ignition is switched ON.

Disconnecting a phone

To disconnect a mobile phone from the system:

- Press the  button on the audio panel or touch-screen.
- Enter **##3#*#** on the keypad, and press the  button.

A mobile phone can also be disconnected via the mobile phone's keypad. Refer to your phone's manual for more details.

REJECTING A CALL

(The XJ, X-TYPE and S-TYPE)



Press **CANCEL** on the audio panel to reject an incoming call.

(The XK only)



Press **C/TA** on the audio panel to reject an incoming call.

LAST NUMBER REDIAL

(The XK only)



Press and hold the send/end button on the audio panel to recall the last number dialled. See page 33 for more information.

RECONNECTING A PHONE

Once a mobile phone has been paired with the vehicle, Jaguar may be shown in the phone's list of Bluetooth devices (see your mobile phone manual for more information).

If you manually unpair the phone, it is advisable to delete Jaguar from the list of Bluetooth devices before pairing it with the vehicle again.

Getting Started

EXITING THE VEHICLE

The vehicle telephone system will remain active for six minutes after the ignition is switched OFF. If a call is received during this period, and the mobile phone remains within 10 metres of the vehicle, the call will still be transferred to the vehicle system: you will not be able to hear the call through the phone.

There are two ways of allowing a call to be taken via the phone:

- Transfer the audio function back to the mobile phone.
- Switch off the Bluetooth connection via the mobile phone (phone will remain paired).

Refer to your mobile phone manual for more information.

SILENT MODE

Certain mobile phones have a Silent mode or profile, which prevents the handset from ringing when a call is received.

If the mobile phone is set to Silent, it will also prevent the vehicle phone system from ringing.



Phone Book

PHONE BOOK TRANSFERS

Any phone numbers stored in your mobile phone book can be copied to the vehicle's phone system.

In most cases, this will happen automatically when you pair the phone with the vehicle.

However, with some mobile phones, you may need to manually transfer the phone book.

- Make sure the vehicle ignition is ON and the vehicle and phone are paired.
- Press the  button on the audio panel or touch-screen surround.
- Enter ##2## on the audio panel or touch-screen keypad, and press the  button.
- Switch OFF the ignition for 6 minutes, to allow the vehicle Bluetooth system to complete the download process.

If at a later time a different phone is paired with the vehicle, the original phone book will be cleared, and the phone book from the new phone will be transferred instead.

Updating the phone book

Once the phone book has been copied to the vehicle, it will not be updated automatically. You will need to repeat the Transfer procedure (as stated above) to update the phone book.

Certain phones allow single or multiple phone book entries to be transferred to the vehicle (refer to the manual of your specific mobile phone for more information). These entries will be added to the end of the vehicle phone book.

Note: The location number of phone book entries stored on your mobile phone may change once they are transferred to the vehicle phone book: location numbers are not preserved when phone books are copied via Bluetooth.

If you wish to clear the vehicle phone book completely, unpair (disconnect) the vehicle and mobile phone manually, see page 23. Switch the ignition OFF, and wait for 6 minutes before switching the ignition ON.

The phone book can then be transferred again once the phone and vehicle are paired.

If you wish to pair a new phone with the vehicle and replace the current vehicle phone book, follow the relevant pairing procedure on page 21. Once paired, switch the ignition OFF, and wait for 6 minutes before switching the ignition ON.

Note: If the ignition is not switched OFF for 6 minutes, phone book entries from the new phone may be merged with existing entries in the vehicle phone book. It will also help to ensure that all phone book entries from the new phone are transferred automatically to the vehicle (if your phone supports this feature).

Phone Book

Phone book capacity

Mobile Phone Configuration	Vehicle Phone Book Capacity
Phone supports phone memory and SIM card downloads.	500 (max. of 250 from phone memory, and 250 from SIM card)
Phone only supports phone memory downloads.	500 (from phone memory)
Phone only supports SIM card downloads.	500 (from SIM card)
Phone doesn't support phone memory or SIM card downloads.	0

The system can store a maximum of 500 entries but this figure varies, depending on the type of mobile phone used.

Certain mobile phones store the phone book in two different areas: the SIM card and the phone memory. With some mobile phones, it is not possible to transfer addresses stored in one or both of these areas. The table above explains how this affects the number of entries that can be stored in the vehicle phone book.

Note: *Certain mobile phones do not allow phone book entries stored on the SIM card to be transferred via Bluetooth. However, it may be possible to transfer the SIM phone book to the mobile phone's memory, before copying it to the vehicle phone book. Refer to your mobile phone manual for more information.*

Phone book suffixes

With some mobile phones, it is possible to store phone numbers in different categories:

- Work/Office
- Mobile
- Home

If numbers are stored in your mobile phone in these categories, the vehicle phone book will add a suffix to each entry: WK (work/office), MN (mobile) or HM (home).

This enables the system to handle contacts who have several different phone numbers.

Hands-free Controls

STEERING WHEEL CONTROLS

The XJ, X-TYPE and S-TYPE

Four system control switches are situated on the left-hand side of the steering wheel, duplicating the functions of buttons on the audio panel. These switches provide finger-tip control of audio, telephone and voice activation systems whilst driving.

The XJ and S-TYPE only

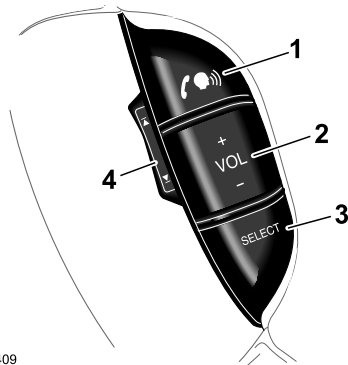

JOL3409

X-TYPE only

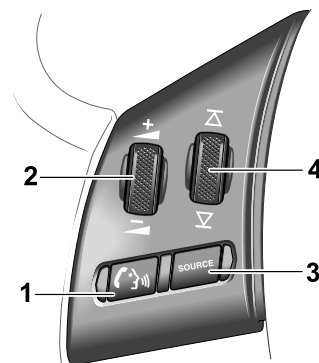

JOL2540

The following table describes the functions of the steering wheel controls for the XJ, S-TYPE and X-TYPE.

Switch	Function
1	Start voice function, or mute where voice not fitted. Answer phone call when ringing. Send/End when in Phone mode.
2	Increase/decrease volume.
3	Hold for 2 seconds to select Phone Ready mode. Press and release to cycle through FM, AM, cassette, CD or MD and CD Changer.
4	In Phone mode, scroll through stored numbers. In Audio mode, scroll through radio stations or CD/MD tracks. Press and hold to select next strong radio station, next CD or change cassette side.

Note: For X-TYPE, switches 2 and 4 are part-rotating switches that self-centre when released. For XJ and S-TYPE, switches 2 and 4 are rocker switches.

Hands-free Controls

Audio panel control functions

The audio panel controls for the XJ, S-TYPE and X-TYPE are described below.

Volume control

During a call, the phone volume can be adjusted with the audio panel volume control or the steering wheel switches.

The volume will be memorised for future calls (this will not alter other audio volume settings).

To adjust: During a phone call, press **MODE** on the audio panel repeatedly until **Fade** is displayed. Using the volume control knob or the steering wheel button, set the fade volume to your personal preference.

Phone mode



This button will activate the phone mode, ready to make a call. The display will indicate that phone mode has been selected.

This function can also be controlled from the steering wheel: press and hold button **3**, see page 27.

Keypad



Press the digits to enter the required telephone number. Each key press will beep and the digits will be displayed on the audio panel.

The keypad can also be used in Memory Recall (**MR**), to enter a location number, or to scroll up/down the memory locations.

Cancel



Press and release **CANCEL** to clear the last digit of a telephone number.

Press and hold **CANCEL** to clear all digits entered.

Send/end



Press this button to dial the entered telephone number. It is also used to end a call that is in progress.

Memory recall



Press to access the phone memory location number.

Either a memory location number can be entered from the keypad, or memory locations can be scrolled up and down from the keypad scroll keys.

This function can also be controlled using steering wheel button **4**, see page 27.

Press the upper or lower part of the control to seek up or down through the numbers in the phone memory.

Last number redial may also be activated by pressing and holding the **MR** button.

Hands-free Controls

The XK only

Four system control switches are situated on the left-hand side of the steering wheel, duplicating the functions of buttons on the audio panel.

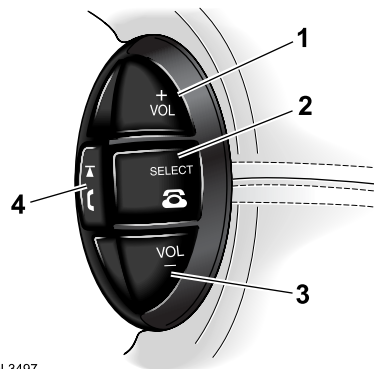

JOL3497

Switch	Function
1	Increase volume.
2	Press and hold to access phone mode. Momentarily press and release to exit phone mode.
3	Decrease volume.
4	Press and release to scroll up to next memory location.

Audio panel control functions

The audio panel controls for the XK are described below.

Volume control and fader

During a call, the phone volume can be adjusted with the audio panel volume control or the steering wheel switches.

The volume will be memorised for future calls (this will not alter other audio volume settings).

To adjust: During a phone call, press **MODE** on the audio panel repeatedly until **Fade** is displayed. Using the volume control knob or the steering wheel button, set the fade volume to your personal preference.

Phone mode



This button will activate the phone mode, ready to make a call. The display will indicate that phone mode has been selected.

This function can also be controlled from the steering wheel: press and hold button **2**, see illustration opposite.

Keypad



Press the digits to enter the required telephone number. Each key press will beep and the digits will be displayed on the audio panel.

The keypad can also be used in Memory Recall (**MR**), to enter a location number, or to scroll up/down the memory locations.

Clear



Press and release **C/TA** to clear the last digit of a telephone number.

Press and hold **C/TA** to clear all digits entered.

Hands-free Controls

Send/end



Press this button to dial the entered telephone number. It is also used to end a call that is in progress.

This function can also be controlled from the steering wheel: press and hold button **4** (see page 29).

CD or TAPE



When a call has ended, press this button to cycle through CD, Tape or insert a tape function.

Note: These buttons are inoperative during a phone call.

Memory recall



Press to access the phone memory location number. Either a memory location number can be entered from the keypad, or memory locations can be scrolled up and down from the keypad scroll keys.

This function can also be controlled using the steering wheel button **4**, see page 29. Press the upper or lower part of the control to seek up or down through the numbers in the phone memory.

Display messages - all vehicles

The following messages may be displayed:

- **Call** - There is an incoming call.
- **Calling** - A call is being established.
- **Empty** - Memory location is empty.
- **Location** - Memory location number or prompt for memory location number.
- **No service** - No cellular or Bluetooth service is available.
- **Phone** - System entering phone mode.
- **Please Wait - phone book information loading** - A short delay will be experienced whilst information is transferred from your mobile phone.
- **SIG** - System Indicator Gauge: this indicates the current status of the Bluetooth telephone system.



Hands-free Operation

RECEIVING A CALL



An incoming call automatically switches the sound system into the phone mode. The audio panel display will show Call and the phone will ring through the vehicle's audio system.

If automatic answer has been programmed the call will automatically answer after two rings.

To answer:

Press  the steering wheel or;
press  the audio panel.

To end:

Press  the steering wheel or;
press  the audio panel.

Call line Ident

If the caller has the call line ident (CLI) feature, **Call** is shown on the audio panel display, followed by the caller's phone number and name (when available). The display may truncate lengthy names.

MAKING A CALL

When making a call, there are three methods of dialling: keypad, memory search and last number redial.

Keypad dialling

To dial:

Press and hold  on the steering wheel or;

press  on the audio panel.

Phone will be displayed.

Key in the phone number on the audio panel keypad. The number will be displayed.

To connect:

Press  on the steering wheel or;

press  on the audio panel.

The display will show **Calling**.

To end:

Press  on the steering wheel or;

press  on the audio panel.

Hands-free Operation

Speed dialling

Note: Speed dialling selects the first nine locations stored in your phone's address book.

To dial:

Press and hold  on the steering wheel or;

press  on the audio panel.

Phone will be displayed.

On the audio panel keypad, press and hold the required speed dialling memory location number **1 to 9**, which **corresponds with locations 1 to 9 in your mobile phone's address book.**

After three seconds, **Calling** will be displayed.

To end:

Press  on the steering wheel or;

press  on the audio panel.

Note: Speed dialling can only be used once your mobile phone's address book has been transferred to the vehicle's phone system. For more information, refer to page 25.

MEMORY RECALL DIALLING

Using audio panel

Press  the audio panel.

Phone will be displayed.

Press the **MR** button.

Location will be displayed.

On the audio panel keypad, press required memory number **1 to 499**.

Note: The location number of phone book entries stored on your mobile phone may vary from those stored in the vehicle phone book.

To connect:

Press  the steering wheel or;

press  the audio panel.

The display will show **Calling**.

To end:

Press  the steering wheel or;

press  the audio panel.

Using steering wheel controls

Press and hold button **3**, see page 27.

Phone will be displayed.

On the audio panel keypad, press required memory number **1 to 749**.

To connect:

Press  the steering wheel or;

press  the audio panel.

The display will show **Calling**.

To end:

Press  the steering wheel or;

press  the audio panel.



Hands-free Operation

LAST NUMBER REDIAL

Note: Last number redial recalls the phone number of the last call made since the ignition was switched on.

When the ignition is switched off, the last number called may be lost from the system memory.

To dial:



Press  the steering wheel or; press  the audio panel.

Phone will be displayed.

On the audio panel, press and hold the **MR** button. The display will show the last number called.



Note: If the last number was dialed using the audio panel keypad, you can change the number by pressing **Cancel**.

To connect:

Press  the steering wheel or; press  the audio panel.

The display will show **Calling**.

To end:

Press  the steering wheel or; press  the audio panel.

MULTIZONE VOICE

(The XJ only, if fitted)

To transfer control of the phone from the rear of the vehicle to the front, when not on a call, press  once.

The display will show **Phone In Use**.

Press  a second time and the display will show **Phone**.

The rear system is now out of phone mode and the front occupants have full, hands-free control.

To transfer control of the phone during a call, press .

For more detailed information, please refer to the Rear Multimedia handbook.

Touch-screen Controls

OVERVIEW

On vehicles fitted with the navigation system, the audio panel keyboard is replaced with touch-screen controls.

Control of the system via the steering wheel controls is unchanged, as described in the previous section.

With the ignition switch in position **I** or **II**, pressing the  button to the left of the screen will display the following screen controls.



JOL3513

The message window to the right of the screen will provide information on the telephone system's status. The display will show **Phone Connected** if the phone is correctly connected, or **No BT Phone** if the phone is not properly connected.

MAKING A CALL





JOL3513

Calls are made by using the digit and  touch-controls, or the memory functions described on page 35.

Erroneous digits can be deleted by touching .

The number called is displayed at the top of the screen.

The screen will display **Calling** when establishing a call. On connection, **Connected** is displayed and  illuminated.

If the ignition is switched off, the call will be maintained and the touch-screen can be manually turned off. Touch  to terminate the call.

Touch-screen Controls

RECEIVING A CALL



JOL1781

On receipt of a call, the screen will display **Incoming Call** regardless of the audio system operating mode.

This is accompanied by **Accept** and **Cancel** touch-controls, enabling the user to answer the call or cancel it.

OTHER FUNCTIONS

Using the menu

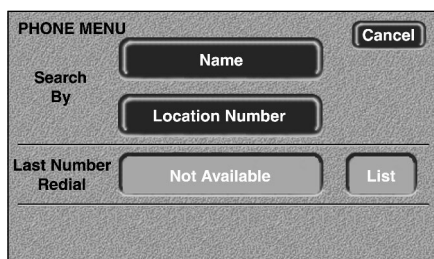

JOL3495

Touch **Menu** to display the above screen. This screen provides access to memory functions and last number redial.

When the vehicle is in motion, it will not be possible to use the **Name** touch-control.

Last number redial

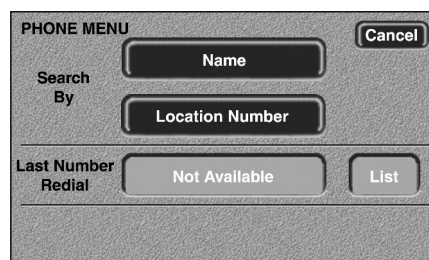

JOL3495

The **Last Number Redial** memory function enables the user to quickly recall the previously used number.

Use of the touch-control automatically call the previous number and reverts to the standard phone display, with the call timer and  activated.

Use of the **List** touch-control will display the last ten numbers dialled.

Note: *Last Number Redial* recalls the last ten numbers called since the ignition switch was turned to position **I** or **II**. The list may be lost each time the ignition is switched off.

Searching by Name

It is possible to list names stored in the vehicle phone book, whilst the vehicle is in motion.



WARNING:

Jaguar recommends that the driver does not use this feature whilst the vehicle is in motion. Give full attention to driving - safe driving is your first responsibility.

Touch-screen Controls

Location number

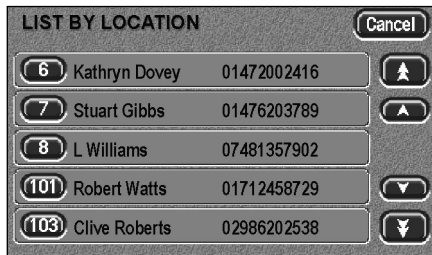

JOL2718

The **Location Number** screen enables the user to search the phone memory by location.

Upon pressing the location number touch-control, a location number is requested. A list of locations is then displayed as above (dependent upon those stored in the memory). The desired location may then be dialled by touching the location number.

When the vehicle is in motion, the scroll touch controls at the right-hand side of the touch-screen will be inhibited for safety.

Note: *The location number of phone book entries stored on your mobile phone may vary from those stored in the vehicle phone book.*

Name entry



JOL1782

On the phone menu, select **Name**. The screen above will be displayed. Touch the required alphabetical group to narrow your search, then scroll through the list.

List by name



JOL2719

With the memory list displayed above, scroll through the list of names using the arrowed buttons. Touch the desired list number to make the call.

Use  to terminate the call.

Touch-screen Controls

MULTIZONE VOICE

(The XJ only, if fitted)

To transfer control of the phone from the rear of the vehicle to the front, when not on a call, press  once.

The display will show **Phone In Use**.

Press  second time and the screen below will be displayed:



The rear system is now out of phone mode and the front occupants have full hands-free control.

To transfer control of the phone during a call, press .

For more detailed information, please refer to the Rear Multimedia handbook.

ADDITIONAL INFORMATION



Continuity of calls

Whilst in a call in hands-free mode, the call remains connected if the vehicle ignition is turned OFF (position **0**). When the call ends, another call cannot be made or received through the vehicle system unless the ignition switch is turned to position **I** or **II**.

DTMF tones

Whilst in a call you can transmit a DTMF (Dual Tone Multi-Frequency) tone, to remotely control equipment such as an answering machine. Key in the appropriate numbers on the audio panel keypad. The numbers entered will be displayed on the audio panel.

Scratch pad

During a call, the audio panel keypad may be used to store a number to be dialled once the current call is terminated. The number entered will be displayed on the audio panel: once the current call is terminated, the number can be dialled by pressing  on the steering wheel, or  on the audio panel.

Note: DTMF tones may be heard when entering a number.

Changing a phone number

When making a call, you can change the phone number shown on the audio display using the CANCEL button (audio panel) or C (touch-screen).

A momentary press erases any single digit, a long press erases the complete number.

PIN feature

The PIN feature is not supported at present by the Bluetooth telephone system.

Therefore, please ensure that your mobile phone is not locked by a PIN whilst it is connected to the Bluetooth telephone system.

Voice Activation

JAGUARVOICE OVERVIEW

(Where fitted)

Voice activation enables you to activate the main functions of the telephone system by speaking to it. This avoids the need to operate controls manually, allowing you to concentrate fully on driving the vehicle.

In addition, the vehicle's telephone system allows up to 25 phone numbers to be stored, which can be recalled with voice commands. Each phone number must be allocated a voice tag; a single spoken command which can be used to recall the phone number.

Note: *The system does not use your mobile phone's address book. Voice tags are stored separately in the vehicle's telephone system.*

The voice activation system prompts you with announcements and questions, to guide you to the required function. For more information, refer to the audio systems and JaguarVoice handbook, or the touch-screen display handbook.



WARNING:

The voice activation system must not be used to call emergency numbers, as voice patterns can change under stress, resulting in commands becoming unrecognisable.

Improving voice recognition

The voice activation system uses a microphone mounted in the vehicle's roof lining. The microphone filters out ambient noise, however these additional points will help to ensure that the commands are properly understood:

- Speak continuously and at a normal volume. Avoid pauses between words and unusual emphasis.
- Do not speak while the system is making an announcement. The system displays LISTENING and beeps while it is waiting for a voice command.
- Noise interference from outside the vehicle may affect the system. It is advisable to keep the doors, windows and sunroof closed.
- If a command is not understood, the system responds with Sorry, Command Not Recognised or No Speech Detected. Please give the command again.
- Avoid background noise in the vehicle, and ask passengers not to talk while you are speaking to the system.
- The microphone is positioned to pick up the driver's voice. Passengers may not be understood as accurately, and are advised instead to speak directly into the mobile phone.

Declaration of Conformity

EUROPEAN UNION DIRECTIVES CONFORMANCE STATEMENT

 Hereby, Jaguar Cars Limited declares that this product is in compliance with:

- The essential requirements and other relevant provisions of Directive 1999/5/EC.
- All other relevant EU Directives.

IMEI: 350034/40/394721/9

 0168

Type: MC2-41H14

The above gives an example of a typical Product Approval Number.

You can view your product's Declaration of Conformity (DoC) to Directive 1999/5/EC (the R&TTE Directive) at:

- www.motorola.com/rtte

To find your DoC, enter the Product Approval Number from your product's label in the Search bar on the website.

The Bluetooth word mark and logos are owned by the Bluetooth SIG, Inc. and any use of such marks by Jaguar Cars Limited is under licence. Other trademarks and trade names are those of their respective owners.

EXPORT CONTROLS

This product contains commodities, technology or software exported from the United States in accordance with the Export Administration regulations. Diversion contrary to U.S. or Canadian law is prohibited.

FCC/INDUSTRY CANADA NOTICE

This device complies with Part 15 of the FCC rules. Operation is subject to the following two conditions: (1) this device may not cause harmful interference, and (2) this device must accept any interference received, including interference that may cause undesired operation.

FCC ID: IHDBTUM

IC: 109BTUM

Changes or modifications not expressly approved by the party responsible for compliance could void the user's authority to operate the equipment.

Note: *This equipment has been tested and found to comply with the limits for a Class B digital device, pursuant to part 15 of the FCC Rules. These limits are designed to provide reasonable protection against harmful interference in a residential installation.*

This equipment generates, uses and can radiate radio frequency energy and, if not installed and used in accordance with the instructions, may cause harmful interference to radio communications. However, there is no guarantee that interference will not occur in a particular installation.

Declaration of Conformity

If this equipment does cause harmful interference to radio or television reception, which can be determined by turning the equipment off and on, the user is encouraged to try to correct the interference by one or more of the following measures:

- *Reorient or relocate the receiving antenna.*
- *Increase the separation between the equipment and receiver.*
- *Connect the equipment into an outlet on a circuit different from that to which the receiver is connected.*
- *Consult the dealer or an experienced radio/TV technician for help.*

Index

Address book	25	Touch-screen controls.....	34
Audio panel.....	19	Last number redial.....	35
Audio Panel, XJ, S-TYPE, X-TYPE ...	28	List by name.....	36
Cancel.....	28	Location number.....	36
Keypad.....	28	Making a call.....	34
Memory recall.....	28	Multizone voice.....	37
Phone mode.....	28	Name entry.....	36
Send/end.....	28	Receiving a call.....	35
Volume control.....	28	Voice activation.....	16, 38
Audio Panel, XK.....	29	Volume.....	15
CD or tape.....	30		
Clear.....	29		
Keypad.....	29		
Memory recall.....	30		
Phone mode.....	29		
Send/end.....	30		
Volume control.....	29		
Bluetooth description.....	15		
Call continuity.....	37		
Call volume.....	15		
Changing a phone number.....	37		
Declaration of conformity.....	39		
Display messages.....	30		
DTMF tones.....	37		
Hands-free operation.....	31		
Last number redial.....	33		
Making a call.....	31		
Memory recall dialling.....	32		
Multizone voice.....	33		
Receiving a call.....	31		
Speed dialling.....	32		
Messages.....	30		
Pairing.....	21		
Phone book.....	25		
PIN.....	37		
Safety.....	17		
Steering wheel controls.....	27		
XJ, S-TYPE, X-TYPE.....	27		
XK.....	29		
System overview.....	15		

Free Manuals Download Website

<http://myh66.com>

<http://usermanuals.us>

<http://www.somanuals.com>

<http://www.4manuals.cc>

<http://www.manual-lib.com>

<http://www.404manual.com>

<http://www.luxmanual.com>

<http://aubethermostatmanual.com>

Golf course search by state

<http://golfingnear.com>

Email search by domain

<http://emailbydomain.com>

Auto manuals search

<http://auto.somanuals.com>

TV manuals search

<http://tv.somanuals.com>