

# JENN-AIR® Triple Bay Conventional Gas Grill Cooktop

## PRODUCT MODEL NUMBERS

JGD8348CD

## GAS REQUIREMENTS

**Gas supply:** The installation of this appliance must conform with local codes, or in the absence of local codes, with the latest edition of the National Fuel Gas Code ANSI Z223.1 USA or current CAN/CGA-B149 INSTALLATION CODE.

This appliance was adjusted at the factory for use with natural gas. If, at any time, this appliance is to be used with a different type of gas, all of the conversion adjustments described in the installation instructions must be made by a qualified service technician before attempting to operate the cooktop on that gas.

The maximum gas supply pressure for the appliance pressure regulator supplied on this appliance is 14" W.C. The test pressure for checking this appliance pressure regulator must be at least 6" W.C. for Natural Gas, and at least 11" W.C. for LP. It is shipped from the factory set for Natural Gas at 5" W.C.

Install a manual shutoff valve in an accessible location in the gas line external to this appliance for the purpose of turning on or shutting off gas to the appliance.

Make the gas connection to the inlet of the appliance pressure regulator on this appliance with a 1/2" male pipe thread. Use an approved pipe joint compound resistant to the action of LP gas at pipe connections.

**Electrical:** See page 2.

## PRODUCT DIMENSIONS

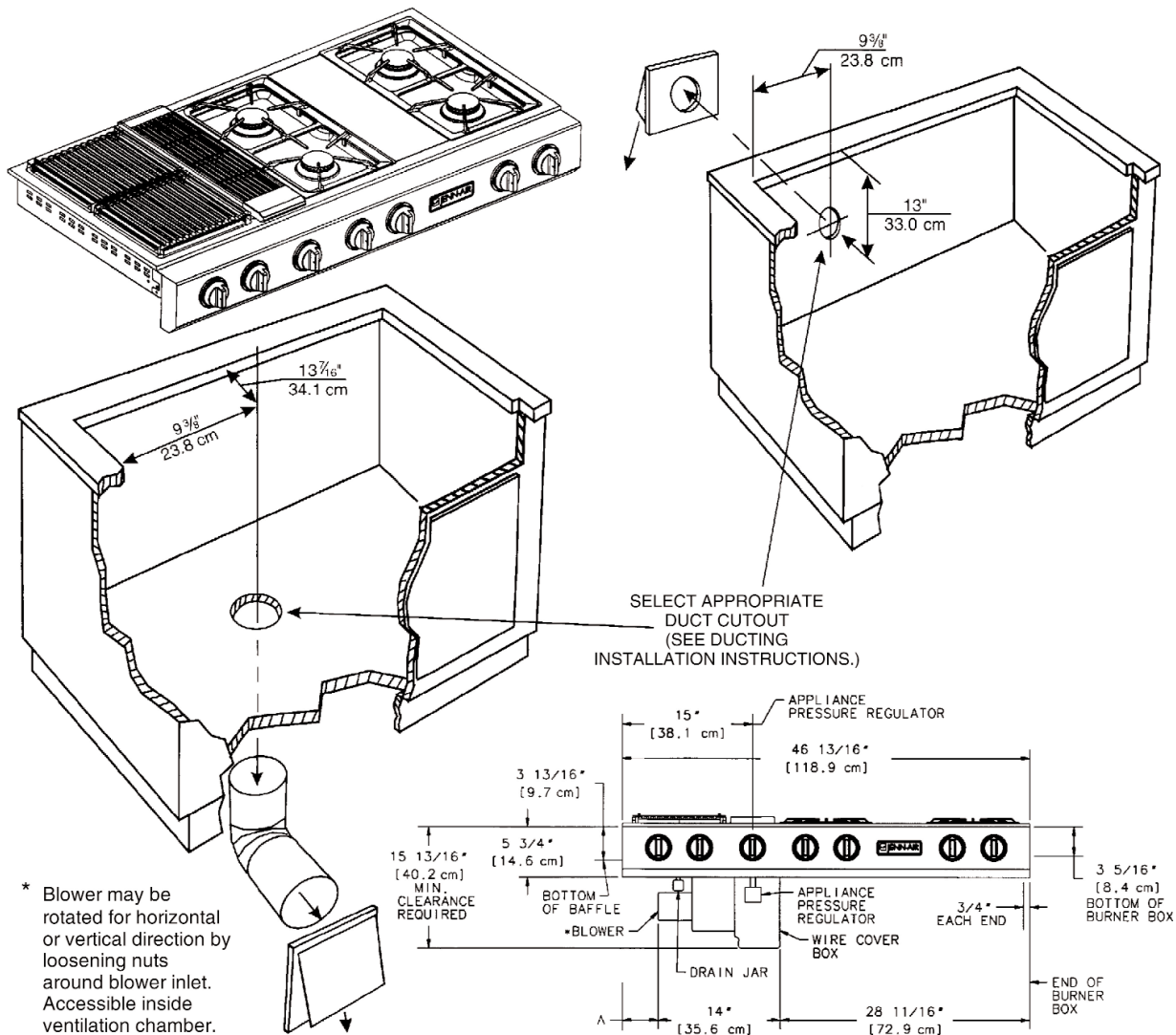

Dimension "A" - provide 2" min. (5.1 cm) cabinet clearance to motor for cooling purpose.

**NOTE:** Where possible, 6" (15.5 cm) is recommended for motor/blower service.

Side Clearance: Grills installed near a side wall must allow a minimum clearance of 8" (20.3 cm).

Access must be provided to remove and empty grease container.

This appliance is designed to always be vented outdoors.

# JENN-AIR® Triple Bay Conventional Gas Grill Cooktop

## PRODUCT MODEL NUMBERS

JGD8348CD

## ELECTRICAL REQUIREMENTS

The electrical supply required is 110/120-volt, A.C., 15-amp, 60-Hz. This appliance is equipped with a grounded type power cord. A grounded outlet must be provided. It is recommended, for convenience, this outlet be located in the area shown in the shaded illustration. This appliance, when installed, must be electrically grounded in accordance with local codes or, in the absence of local codes, with the latest edition of the National Electrical Code ANSI/NFPA No. 70 USA or current CSA STANDARD C22.1 Canadian Electrical Code part 1.

User may experience occasional circuit tripping if Ground Fault Circuit Interrupter (GFCI) outlet or breaker is in use.

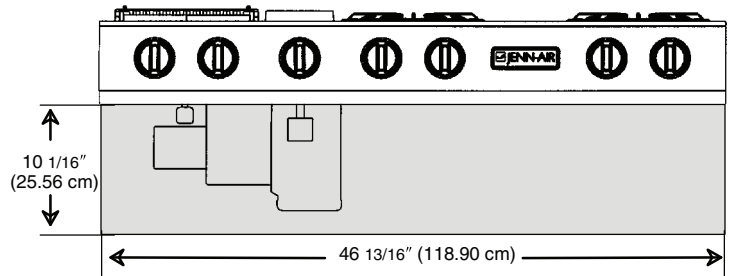

## CABINET AND COUNTERTOP CUTOUTS

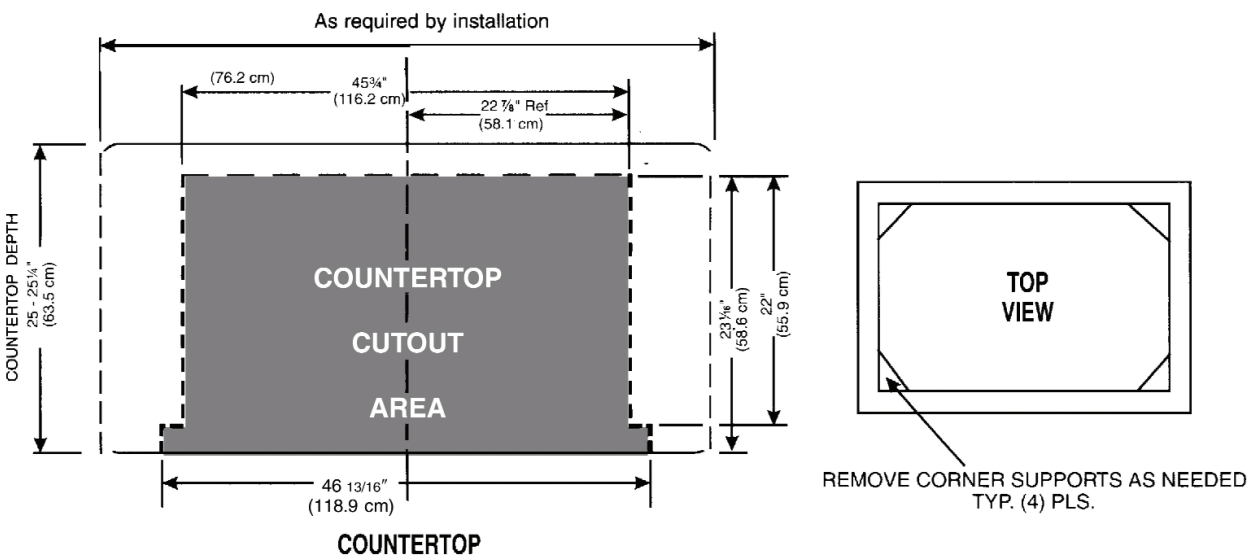
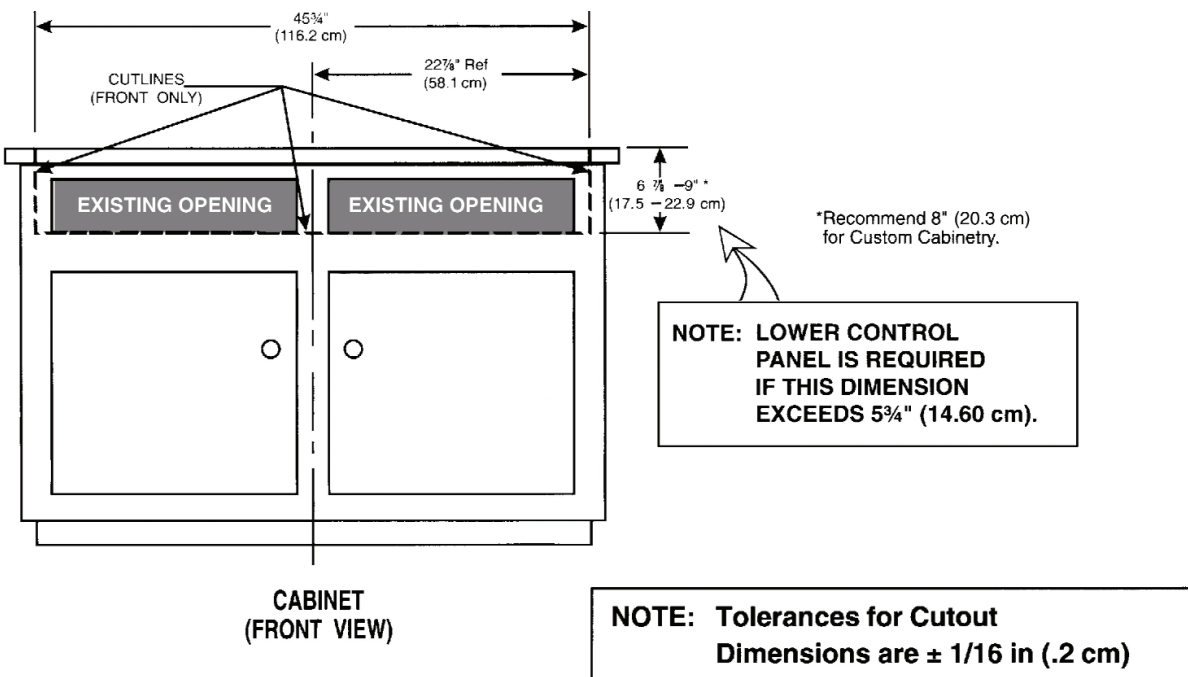

# JENN-AIR® Triple Bay Conventional Gas Grill Cooktop

## PRODUCT MODEL NUMBERS

JGD8348CD

## INSTALLATION OF CABINETRY OVER YOUR GRILL

Minimum horizontal clearance between the edge of the appliance and combustible construction extending from the cooking surface to 18" (45.7 cm) above the cooking surface is:

- 1-3/4" (4.5 cm) at rear
- 8" (20.3 cm) at sides

**NOTE:** This is not the recommended clearance, but minimum allowable clearance.

\* A = 30" (76.2 cm) minimum vertical clearance between cooking surface and construction above the appliance.

B = 13" (33.0 cm) maximum depth of cabinets installed above cooking top.

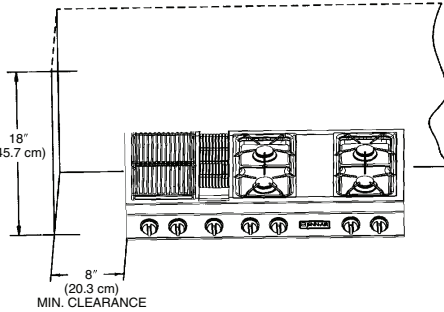

Avoid use of cabinets above cooktop for storage space to eliminate associated potential hazards such as reaching over open flames.

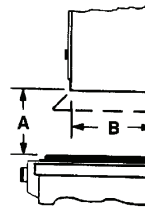

Dotted lines indicate range hood construction.

\* To eliminate the risk of burns or fire by reaching over heated surface units, cabinet storage space located above the surface units should be avoided. If cabinet storage is to be provided, the risk can be reduced by installing a range hood that projects horizontally a minimum of 5" (12.7 cm) beyond the bottom of the cabinets.

### Cabinets Above Cooking Top

Maximum depth of cabinets installed above cooking top is 13" (33 cm).

## MINIMUM SPACING REQUIREMENTS

For installing a TripleBay Downdraft Cooktop in combination with another Downdraft Cooktop, the minimum spacing between adjacent units must be provided, as shown, for satisfactory performance.

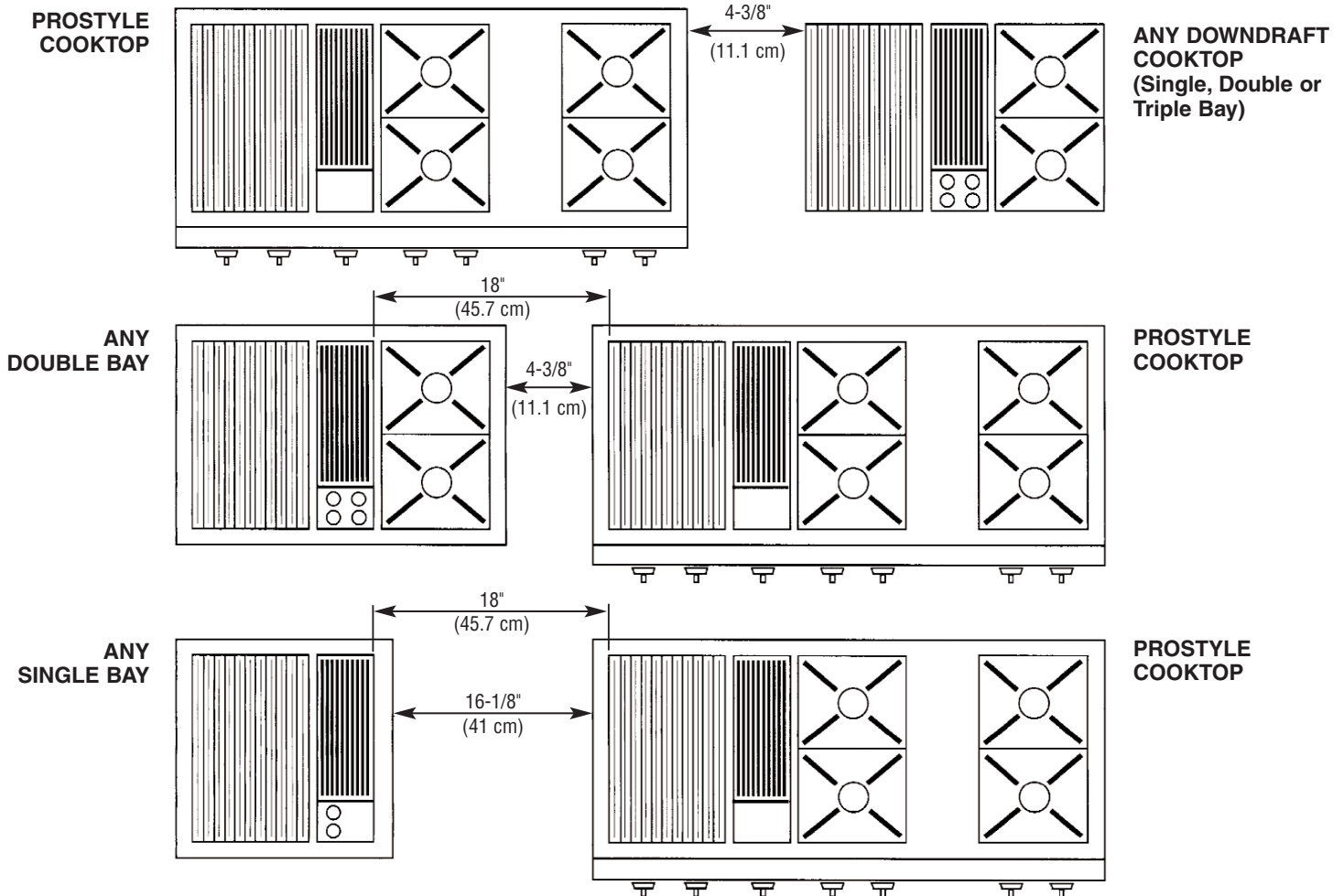

## Free Manuals Download Website

<http://myh66.com>

<http://usermanuals.us>

<http://www.somanuals.com>

<http://www.4manuals.cc>

<http://www.manual-lib.com>

<http://www.404manual.com>

<http://www.luxmanual.com>

<http://aubethermostatmanual.com>

Golf course search by state

<http://golfingnear.com>

Email search by domain

<http://emailbydomain.com>

Auto manuals search

<http://auto.somanuals.com>

TV manuals search

<http://tv.somanuals.com>