

36" INDUCTION COOKTOP

JIC4536X – 36¼" x 4⅛" x 21⅜"

PRODUCT DIMENSIONS

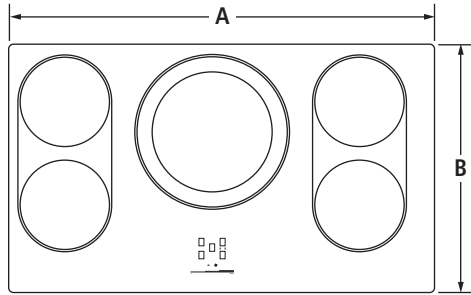

TOP VIEW

MODEL #		JIC4536X	
		in	cm
A	Overall width	36¼	92.2
B	Overall depth	21⅜	54.1
C	Width of recessed cooktop	32½	82.6
D	Height of recessed cooktop	3⅛	8.0
E	Recessed height including front flange	3⅞	9.8
F	Height of cooking surface Euro-Style Stainless (including trim)	¼	0.6
	Floating Glass	⅛	0.4
G	Depth of recessed cooktop	18⅞	47.9
H	Recessed height including electrical conduit	4⅛	10.5

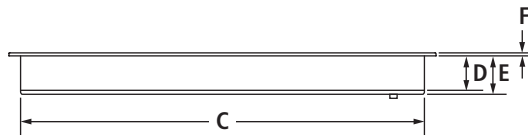

FRONT VIEW

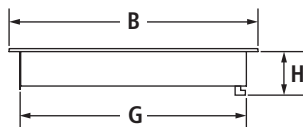

SIDE VIEW

36" INDUCTION COOKTOP

JIC4536X – 36¼" x 4⅛" x 21⅜"

OPENING/CLEARANCE DIMENSIONS

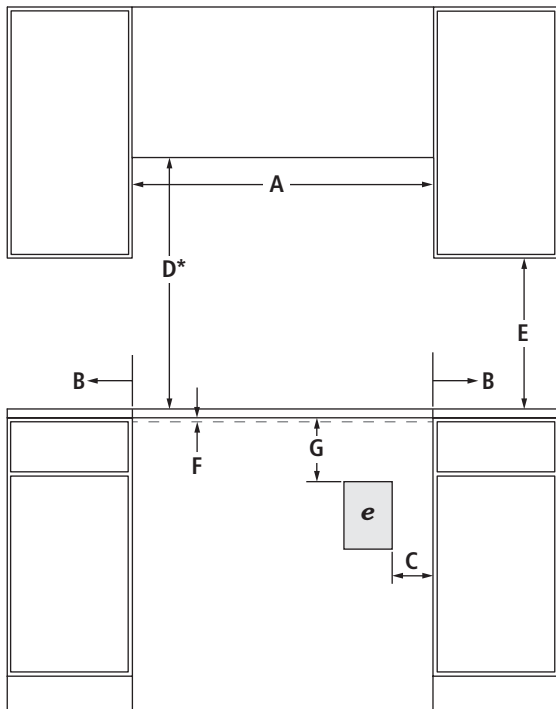

FRONT VIEW

MODEL #		JIC4536X	
		in	cm
A	Width of combustable area above cooking surface (min.)	33⅞	84.0
B	Width from cooktop to fixed wall or other combustable material (min.)	1	2.5
C	Width to outer edge of outlet (min.)	10	25.4
D*	Height to bottom of uncovered wood or metal cabinet above cooking surface (min.)	30	76.2
E	Height to bottom of uncovered wood or metal cabinet (min.)	18	45.7
F	Required height of ventilation opening in front cabinet under countertop for proper ventilation – full width of cooktop	¾	0.5
G	Height to top edge of outlet (min.)	12	30.5
H	Depth of upper cabinet (recommended)	13	33.0
I	Depth from cutout to wall (min.)	1	2.5
J	Width of cutout	33⅞	84.0
K	Depth of cutout	19¼	49.0
L	Depth from cutout to front of countertop	2	5.1
e	Recommended electrical access location		

*Dimension can be reduced by 6" (15.2 cm) when bottom of wood or metal cabinet is covered by not less than ¼" (0.6 cm) flame retardant millboard covered with not less than No. 28 MSG sheet metal, 0.015" (0.4 mm) stainless steel, 0.024" (0.6 mm) aluminum or 0.020" (0.5 mm) copper.

If installing a hood or microwave hood combination above the cooktop, follow the hood or microwave hood combination instructions for dimensional clearances above the cooking surface.

ELECTRICAL REQUIREMENTS

240 volt, 60 Hz, AC only, 50-amp fused, grounded circuit is required. A dedicated circuit is recommended. The length of conduit provided is for serviceability to the cooktop.

LOCATION REQUIREMENTS

- To ensure cooktop base clearance, cabinet side walls need to be wider than the cutout.
- If cabinet has a drawer, allow a 5⅞" (13.0 cm) minimum clearance between countertop and top of drawer.

COOKTOP OVER SINGLE WALL OVEN INSTALLATION REQUIREMENTS

- For approved model number combinations, refer to the under counter label on the bottom of the cooktop burner box.
- To install a cooktop over a single wall oven, refer to page 3.

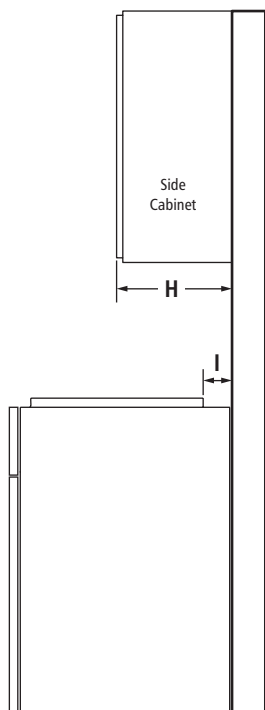

SIDE VIEW

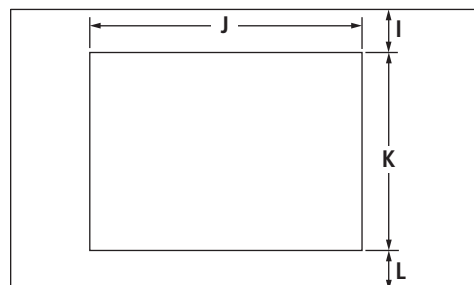

TOP VIEW – CUTOUT

SINGLE WALL OVEN AND COOKTOP COMBINATIONS

For the approved model number combinations, refer to the under counter label located on top of the oven chassis and on the bottom of the cooktop burner box.

APPROVED MODEL NUMBER COMBINATIONS

SINGLE WALL OVENS

30-Inch: JJW3430W, JJW2430W, JJW2330W
 27-Inch: JJW2427W, JJW2327W

INDUCTION COOKTOPS

36-Inch: JIC4536X
 30-Inch: JIC4430X

GAS COOKTOPS

36-Inch: JGC9536BD, JGC1536AD, JGC8536BD
 30-Inch: JGC9430BD, JGC1430AD, JGC8430CD

ELECTRIC COOKTOPS

36-Inch: JEC4536Y, JEC9536BD, JEC8536BD
 30-Inch: JEC4530Y, JEC9530BD, JEC8430BD

OPENING/CLEARANCE DIMENSIONS

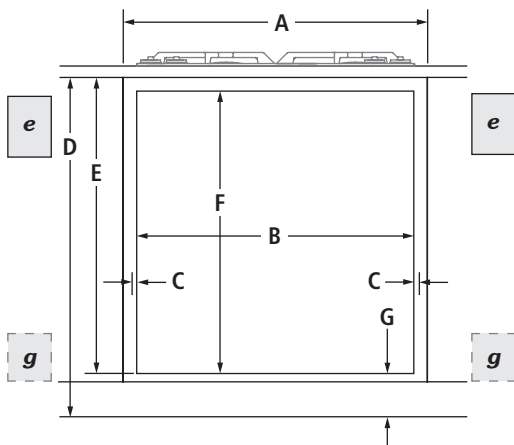

FRONT VIEW –
 UNDER COUNTER INSTALLATION
 (with cooktop installed above)

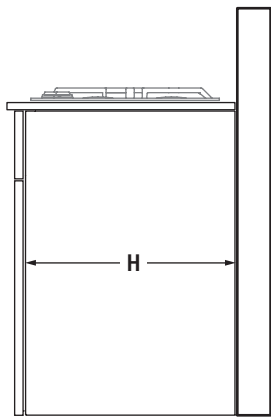

SIDE VIEW –
 UNDER COUNTER INSTALLATION
 (with cooktop installed above)

MODEL #	JJW3430W JJW2430W JJW2330W		JJW2427W JJW2327W	
	in	cm	in	cm
A	Width of cabinet (min.)			
B	Width of cutout (recommended)			
C	Oven trim overlap			
D	Bottom of countertop to floor			
E	Bottom of countertop to bottom of cutout			
	Induction cooktop combination			
	Gas cooktop combination			
F	Height of cutout (recommended)			
	Electric cooktop combination			
G	Bottom of cutout to floor			
	Induction cooktop combination			
	Gas cooktop combination			
H	Depth of cabinet (min.)			
	Electric cooktop combination			
e	Recommended junction box location			
g	Recommended gas supply line location for gas cooktop			

NOTE: For under counter installation, the junction box should be located in the adjacent right or left cabinet. Drill a 1" (2.5 cm) minimum diameter hole in an upper corner of the side wall for access to the junction box.

CABINET REQUIREMENTS

NOTE: When using under counter installation, check cabinet manufacturer's specifications to verify fit.

JENN-AIR® DETAILED PLANNING DIMENSIONS

VENTILATION SELECTION CHART – COOKTOPS

MODEL #	PRO-STYLE™ HOODS			EURO-STYLE ISLAND-MOUNT HOODS		EURO-STYLE WALL-MOUNT HOODS		GLASS COLLECTION ISLAND-MOUNT HOOD	GLASS COLLECTION WALL-MOUNT HOODS		PERIMETRIC HOOD	OILED BRONZE WALL-MOUNT HOODS		EURO-STYLE TELESCOPING DOWNDRAFT SYSTEMS		CUSTOM HOOD LINERS	OVER-THE-RANGE MICROWAVE OVENS
	JXW9048WP	JXW9036WP JXU9136WP	JXW9030WP JXU9130WP	JXI8042WS	JXI8036WS	JXW8036WS JXW8836WS	JXW8030WS	JXI5036WS	JXW5036WS	JXW5030WS	JXP5032WS	JXW6036WR	JXW6030WR	JXD7036YS	JXD7030YS	UXL6048YSSA UXL6036YSSA	JMV9186W JMV8208W
INDUCTION COOKTOPS																	
36-INCH																	
JIC4536X – 5 Elements	■	■	—	★	★	★	—	★	★	—	★	■	—	★	—	★	■
30-INCH																	
JIC4430X – 4 Elements	■	■	■	■	★	★	★	★	★	★	★	■	■	★	★	★	■
CONVENTIONAL GAS COOKTOPS																	
36-INCH (less than 60,000 BTU total)																	
JGC9536BD – 5 Burners	■	■	—	★	★	★	—	★	★	—	★	★	—	★	—	★	■
JGC1536AD – 5 Burners	■	■	—	★	★	★	—	★	★	—	★	■	—	★	—	★	■
JGC8536BD – 5 Burners	■	■	—	★	★	★	—	★	★	—	★	■	—	★	—	★	■
30-INCH (less than 60,000 BTU total)																	
JGC9430BD – 4 Burners	■	■	■	■	★	★	★	★	★	★	★	★	★	★	★	★	■
JGC1430AD – 4 Burners	■	■	■	■	★	★	★	★	★	★	★	■	■	★	★	★	■
JGC8430CD – 4 Burners	■	■	■	■	★	★	★	★	★	★	★	■	■	★	★	★	■
CONVENTIONAL ELECTRIC COOKTOPS																	
36-INCH																	
JEC4536Y – 5 Elements	■	■	—	★	★	★	—	★	★	—	★	■	—	★	—	★	■
JEC9536BD – 5 Elements	■	■	—	★	★	★	—	★	★	—	★	★	—	★	—	★	■
JEC8536BD – 5 Elements	■	■	—	★	★	★	—	★	★	—	★	■	—	★	—	★	■
30-INCH																	
JEC4530Y – 5 Elements	■	■	■	■	★	★	★	★	★	★	★	■	■	★	★	★	■
JEC9530BD – 5 Elements	■	■	■	■	★	★	★	★	★	★	★	★	★	★	★	★	■
JEC8430BD – 4 Elements	■	■	■	■	★	★	★	★	★	★	★	■	■	★	★	★	■

A. Custom hood liners can be used with any of the following blower motors: UXB1200DYS, UXB0600DYS, UXI1200DYS or UXI0600DYS.

KEY	
★	Style and Performance Pair
■	Performance Pair
—	Not Recommended

Product dimension, cutout and installation specifications are provided for planning purposes only. Before installing any product, be sure to verify cutout dimensions and electrical/gas connections as actual product dimensions may vary.

Download from Www.Somanuals.com. All Manuals Search And Download.



Free Manuals Download Website

<http://myh66.com>

<http://usermanuals.us>

<http://www.somanuals.com>

<http://www.4manuals.cc>

<http://www.manual-lib.com>

<http://www.404manual.com>

<http://www.luxmanual.com>

<http://aubethermostatmanual.com>

Golf course search by state

<http://golfingnear.com>

Email search by domain

<http://emailbydomain.com>

Auto manuals search

<http://auto.somanuals.com>

TV manuals search

<http://tv.somanuals.com>