

VV[®]JENN-AIR

Use and Care Manual
**Gas-Electric Grill-Range
with Convection Oven**

Model SVD48600

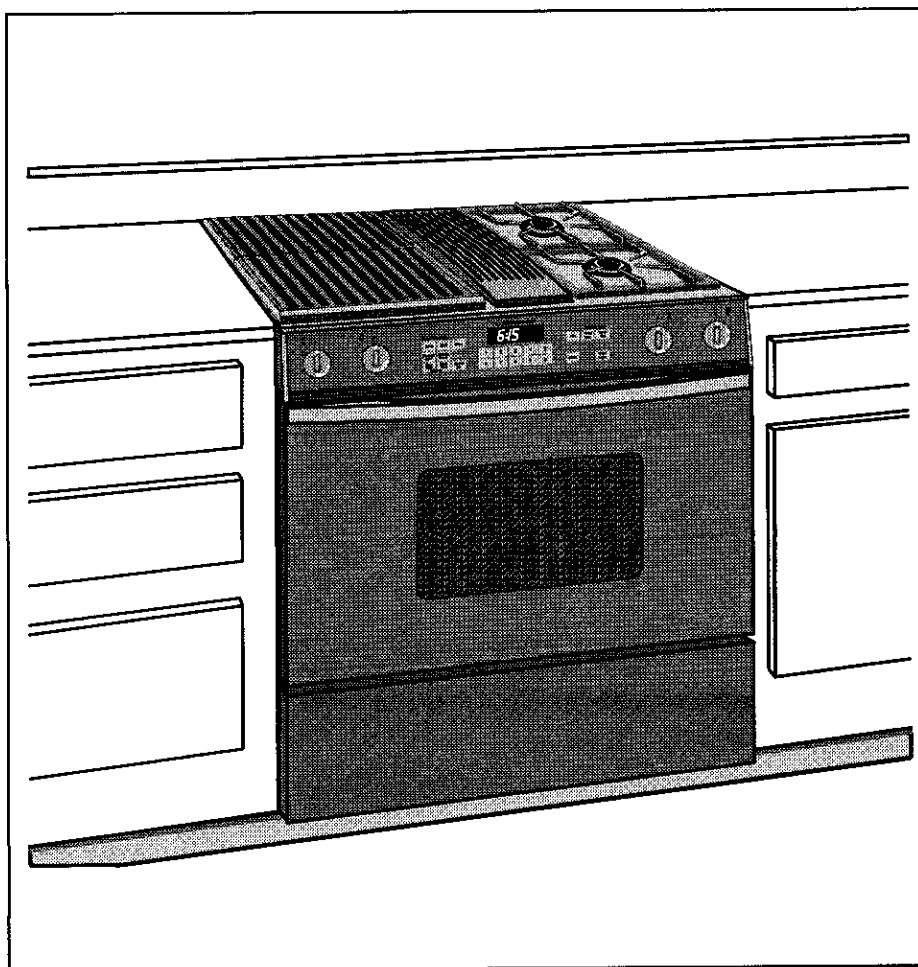

WARNING: If the information in this manual is not followed exactly, a fire or explosion may result causing property damage, personal injury or death.

- **Do not store or use gasoline or other flammable vapors and liquids in the vicinity of this or any other appliance.**

- **WHAT TO DO IF YOU SMELL GAS**
 - **Do not try to light any appliance.**

 - **Do not touch any electrical switch; do not use any phone in your building.**

 - **Immediately call your gas supplier from a neighbor's phone. Follow the gas supplier's instructions.**

 - **If you cannot reach your gas supplier, call the fire department.**

 - **Extinguish any open flame.**

- **Installation and service must be performed by a qualified installer, service agency or the gas supplier.**

- SAVE THESE INSTRUCTIONS FOR FUTURE REFERENCE -

About Your Jenn-Air Range

Congratulations on your choice of a Jenn-Air grill-range. The indoor grilling of meats, fish or fowl is one of the most attractive and succulent methods of preparing these foods . . . a unique flexibility made possible by Jenn-Air's patented integral ventilation system.

Your Jenn-Air self-cleaning oven combines the best of four cooking methods, conventional baking or roasting, convection baking, convection roasting and broiling.

The Jenn-Air convection oven is actually a conventional oven that circulates heated air within the oven. As both bake and broil heating elements cycle on and off with the thermostat, a fan keeps the heated air circulating around the food. The constantly recirculating heated air in the convection oven strips away the layer of cooler air that surrounds the food. Consequently, many foods cook more quickly. Evenly distributed heat makes multiple rack cooking possible. Convection roasted meats retain their natural flavor and juiciness with less shrinkage than conventional roasting.

In addition to the many exclusive benefits of convection cooking, your Jenn-Air oven is also a fine full featured conventional bake and broil oven. You can cook your "old favorite" recipes as you have in the past. The conventional bake oven also gives you the flexibility of preparing various foods when convection cooking may not be as beneficial, as when cooking foods in covered casseroles or clay pots. The broil element is convenient for top browning and oven broiling of foods.

Before you begin cooking with your new range, please take a few minutes to read and become familiar with the instructions in this book. On the following pages you will find a wealth of information regarding all aspects of using your new range. By following the instructions carefully, you will be able to fully enjoy and properly maintain your range and achieve excellent results with the food you prepare.

Should you have any questions about using your Jenn-Air range, write to us. Be sure to provide the model number.

Jenn-Air Customer Assistance
c/o Maytag Customer Service
P.O. Box 2370
Cleveland, TN 37320-2370

Index

Appliance Usage

Before You Call For Service	50-52
Caring For Your Range	
Access Panel	48
Adjust Oven Temperature	48
Child Protection Lock	47
Cleaning Other Parts of Your Range	45-46
How to Remove the Range	48
Oven Light Bulb	47
Range Components	11
Safety Precautions	2, 5-8

Using the Cooktop and Grill

Accessories	49
Cookware Selection	14
Ducting Information	9
Grilling	
Cleaning	20-21
Grilling Guide	19
Grilling Tips	20
Installation	17
Using the Grill	18
How a Surface Burner Works	
Air Shutter Adjustment	12-13
How to Operate in the Event of a Power Failure	12
Low Flame Adjustment	13
Surface Burner Module	16
Surface Controls	15
Ventilation System	10

Using the Oven

Baking	
Baking Charts	31
Causes of Cake Failure	32
Convect Baking	32-33
General Recommendations	30
Broiling	38-39
Clock Controls	
Clock Controlled Baking and Roasting	28-29
Time of Day Clock	26
Timer	27
Oven Cleaning	
Self-Cleaning Process	40-44
Oven Operation	
Oven Control Panel	22-23
Rack Positions	25
Setting Controls	24
Roasting	
Convection Roasting	36
Frozen Convenience Foods	37
General Roasting Recommendations	34
Roasting Chart	35

SAFETY PRECAUTIONS

Read before operating your range

All appliances - regardless of the manufacturer - have the potential through improper or careless use to create safety problems. Therefore the following safety precautions should be observed:

1. Be sure your appliance is properly installed and grounded by a qualified technician.
2. Never use your appliance for warming or heating the room. This warning is based on safety considerations.
3. Children should not be left alone or unattended in area where appliance is in use. They should never be allowed to sit or stand on any part of the appliance.
4. Wear proper apparel. **Loose-fitting or hanging garments** should never be worn while using the appliance.
5. Do not repair or replace any part of the appliance unless specifically recommended in this manual. All other servicing should be referred to an authorized Jenn-Air Service Contractor.
6. Do not store combustible materials, gasoline or other flammable vapors and liquid near cooktop. This also applies to aerosol sprays and aerosol spray cans.
7. Do not use water on grease fires. Smother fire or flame or use dry chemical or foam-type extinguisher.
8. Use only dry potholders. Moist or damp potholders on hot surfaces may result in burns from steam. Do not use a towel or other bulky cloth.
9. Select cookware large enough to properly contain food and avoid boilovers or spillovers. This will save on cleaning and prevent hazardous accumulations of food, since heavy splattering or spillovers left on a cooktop **can** ignite. Pan size is especially important in deep fat frying.
10. Never leave rangetop unattended at **Hi** heat settings. Boilover causes smoking and greasy spillovers that may ignite.
11. **TYPE OF COOKWARE** - Avoid pans that are unstable and easily tipped. In choosing pans, look for easily-grasped handles that will stay cool. Pans that are too heavy when filled with food can also be a hazard. If pan handles twist and cannot be tightened, discard the pan.

12. **HANDLES** - Always turn pan handles to the side or back of the rangetop - not out into the room where they are easily hit. **COOKWARE HANDLES SHOULD BE TURNED INWARD AND NOT EXTEND OVER ADJACENT SURFACE BURNERS** to minimize burns, ignition of flammable materials, and spillage due to unintentional contact with the cookware.
13. **CAUTION** - Do not store items of interest to children in cabinets above range - children climbing on the range to reach items could be seriously injured.
14. Do not touch grill and surface burner areas, or perimeter trim around rangetop or interior surfaces of oven. During and after use, these areas may be hot enough to cause burns. Avoid contact with these areas by clothing or other flammable materials until they have had sufficient time to cool. Other surfaces may become hot enough to cause burns - among these surfaces are the upper door frame and door, oven vent opening and surfaces near the opening, and the top edge of the control panel.
15. Do not heat unopened food containers. Buildup of pressure may cause container to burst and result in injury.
16. Keep all controls "**Off**" when unit is not in use.
17. Keep oven vent ducts unobstructed. The oven is vented under the air grille.
18. **GREASE** - Grease is flammable and should be handled carefully. Never leave any cooking operation unattended. Let fat cool before attempting to handle it. Do not allow grease to collect around the rangetop or in the vents. Wipe up spillovers immediately.
19. If the range is installed near a window, proper precautions should be taken to prevent curtains from blowing over burners creating a **FIRE HAZARD**.
20. Do not use aluminum foil to line aeration tray or burner basin. Restriction of normal air flow may result in unsafe operation.
21. Do not use cookware on the grill section of this appliance.
22. Before servicing your appliance, disconnect power to the range at the main fuse or circuit breaker panel and at the electrical receptacle.
23. Always allow hot pans to cool in a safe place out of the reach of small children.
24. A faint gas odor may indicate a gas leak. If a gas odor is detected, shut off the gas supply to the range. Call your installer or local gas company to have the possible leak checked. **Never use a match or other flame to locate a gas leak.**

25. Clean only parts listed in this manual and use procedures recommended.
26. Flame size should be adjusted so it does not extend beyond the edge of the cookware, this instruction is based on safety consideration.
27. This appliance has been tested for safe performance using conventional cookware. Do not use any devices or accessories that are not specifically recommended in this manual. Do not use eyelid covers for the surface burners, stovetop grills or add-on convection systems. The use of devices or accessories that are not expressly recommended in this manual can create serious safety hazards result in performance problems and reduce the life of the components of the appliance.
28. Glazed cookware - only certain types of glass, glass-ceramic, ceramic, earthenware, or other glazed cookpots are suitable for rangetop surface without breaking due to the sudden change in temperature. Use only such cookware as you know has been approved for this purpose.
29. Avoid placing the range in a main "traffic path" or in an isolated location with no counter space nearby. Visualize the oven in use before selecting a location. Remember that open oven doors may block a passageway and create a hazard.
30. Use care when opening oven door. Let hot air or steam escape before removing or replacing food.
31. Always place oven racks in desired location while oven is cool. If rack must be moved while oven is hot, do not let potholder contact hot heating element in oven.
32. Do not clean door gasket. The door gasket is essential for a good seal. Care should be taken not to rub, damage, or move the gasket.
33. Do not use oven cleaners. No commercial oven cleaner or oven liner protective coating of any kind should be used in or around any part of the oven.
34. **CAUTION: BEFORE SELF-CLEANING THE OVEN, REMOVE FOOD, BROILER PAN AND OTHER UTENSILS.**
35. Listen for fan. A fan noise should be heard during the broil and cleaning cycles. If not, call a serviceman before self-cleaning again.
36. Always remove soiled broiler pan from the broiler compartment after cooking for **grease left in the pan may become hot enough to ignite.**

37. Do not use oven for storage space.
38. Do not allow aluminum foil to contact heating element.
39. **WARNING:** To reduce the risk of tipping the appliance, the appliance must be secured by properly installed anti-tip devices. To check if devices are installed properly, remove the access panel and verify that the anti-tip devices are engaged.
40. **PREPARED FOOD WARNING:** Follow food manufacturer's instructions. If a plastic frozen food container and/or its film cover distorts, warps or is otherwise damaged during cooking, immediately discard the food and its container. The food could be contaminated.

Important Safety Notice and Warning

The California Safe Drinking Water and Toxic Enforcement Act of 1986 (Proposition 65) requires the Governor of California to publish a list of substances known to the State of California to cause cancer or reproductive harm, and requires businesses to warn customers of potential exposures to such substances.

Users of this appliance are hereby warned that when the range is engaged in the self-clean cycle, there may be some low level exposure to some of the listed substances, including carbon monoxide. Additionally, users are also hereby warned that the burning of gas can result in low-level exposure to some of the listed substances, including benzene, formaldehyde and soot, due primarily to the incomplete combustion of natural gas or liquid petroleum (LP) fuels. Properly adjusted burners will minimize incomplete combustion. Exposure to these substances can be minimized by properly venting the range to the outdoors.

- SAVE THESE INSTRUCTIONS -

Important Information

MODEL NUMBER _____

SERIAL NUMBER _____
(numbers appear on the serial plate on the oven front frame)

DATE PURCHASED _____

JENN-AIR DEALER FROM WHOM PURCHASED

ADDRESS _____

CITY _____

PHONE _____

AUTHORIZED JENN-AIR SERVICE CONTRACTOR

ADDRESS _____

CITY _____

PHONE _____

Important: Retain proof of purchase documents for warranty service.

Ducting Information

Jenn-Air's ventilation system is designed to capture both cooking fumes and smoke while grilling. If the system does not, these are some ducting installation situations to check:

- 6" diameter round or 3¼" x 10" rectangular ducting should be used for duct lengths 10'-60'. **Note: 5" diameter round ducting must be used if the duct length is 10' or less.**
- No more than three 90° elbows should be used. Distance between elbows should be at least 18".
- Recommended Jenn-Air wall cap should be used. Make sure damper moves freely when ventilation system is operating.
- There should be a minimum clearance of 6" for cooktop installed near a side wall.

If there is not an obvious improper installation, there may be a concealed problem such as a pinched joint, obstruction in the pipe, etc. Installation is the responsibility of the installer and questions should be addressed first by the installer. The installer should very carefully check the ducting installation instructions.

Ventilation System

The built-in ventilation system removes cooking vapors, odors and smoke from foods prepared on the cooktop, grill and grill accessories. Regular use of this system will insure a more comfortable and less humid kitchen which is free of heavy cooking odors and fumes that normally create a frequent need for cleaning and redecorating.

Using the Ventilation System

- The downdraft ventilation system features a two speed fan. The fan positions are: **Hi**, **Lo**, and **Off**. To turn on the ventilation system, touch the **Fan Pad**. The fan will come on at the **Hi** speed. To set on **Lo** speed, touch the **Fan Pad** (once from **Hi** setting or twice from the **Off** position).

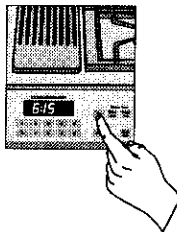

NOTE: There is a five second delay before the fan will switch from **Hi** speed to **Lo** speed.

- A beep will sound every time the **Fan Pad** is touched.
- To turn the ventilation system **Off**, touch the **Fan Pad** (once from **Lo** speed or twice from **Hi** speed).
- The ventilation system will operate *automatically* on **Hi** speed when the grill burner is in use. During grilling, the fan speed is automatically set for the **Hi** setting AND cannot be changed to **Lo** speed.
- Use the **Hi** fan speed for capturing steam. Use **Lo** fan speed for capturing smoke when pan frying.
- The fan can be used to remove strong odors from the kitchen as when chopping onions near the fan.
- Besides using the ventilation system to remove cooking vapors and fumes, it can be used to cool baked pies or cakes. To cool an item, set it on the air grille and turn on the fan. The air being pulled over the item will quickly cool it. Be careful not to cover the oven vent or the entire air grille.

Cleaning the Ventilation System

Air Grille

The air grille lifts off easily. Wipe clean or wash in sink with mild household detergents. It may be cleaned in the dishwasher. **Note:** The oven vent is located under the air grille. When using or cleaning the oven, hot and moist air may be noticed in this area. Be careful not to spill anything into this vent. Remove the air grille before self-cleaning the oven. (See p. 40.)

Filter

Turn off ventilation system before removing. The filter is a permanent type and should be cleaned when soiled. Clean in sink with warm water and liquid dishwashing detergent or in dishwasher. **Important:** DO NOT OPERATE SYSTEM WITHOUT FILTER. Filter should always be placed at an angle. As you face the front of the range, the top of the filter should rest against the left side of the vent opening and the bottom of the filter should rest against the right side of the ventilation chamber at the bottom.



Ventilation Chamber

This area, which houses the filter, should be cleaned in the event of spills or whenever it becomes coated with a film of grease. The ventilation chamber may be cleaned with paper towel, damp cloth, or sponge and mild household detergent or cleanser.

Range Components

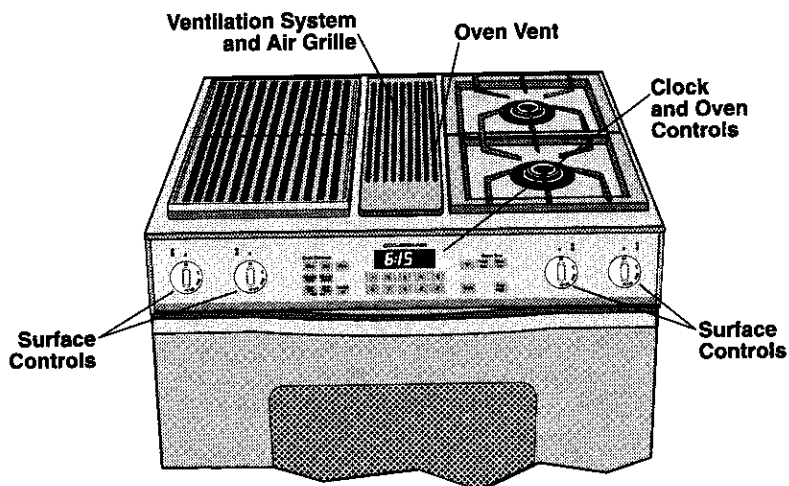

Ventilation System and Air Grille

- Use to capture smoke and steam. (See p. 10.)

Surface Controls

- Use to provide flexibility in setting selection when using the cooktop burners or grill burner. (See p. 15.)

Clock and Oven Controls

- Use the electronic touch controls to set Clock or Oven functions. (Clock - see pp. 26-29, Oven Operation - see pp. 22-25.)

How A Surface Burner Works

Your new cooktop burners have been preset for an "average" set of conditions. Regional variances in gas pressure and atmospheric conditions such as height above sea level may affect your initial flame performance.

When the control knob is turned on, gas enters the mixer tube and mixes with air. This air and gas mixture flows to the burner head and is lighted by a spark from the solid state igniter.

A properly adjusted burner with clean ports will light within a few seconds. The cone-shaped flame will be clear blue in color with a clearly defined inner cone. There should be no trace of yellow in the flame. A yellow flame indicates an improper mixture of air and gas. If your flame does not resemble the "correct" flame as described above, follow the air shutter adjustment instructions below.

The infinite surface controls for the surface burners and grill burner provide flexibility in setting selection.

Note: The grill can be replaced with an optional surface burner module, Model AG202.

How to Operate in the Event of a Power Failure

Surface Burners

In case of prolonged power failure, you can manually light the surface burner by holding a lighted match near the burner ports and slowly turning the control knob counterclockwise (after depressing) until the gas ignites. There is no fan so smoke and condensation can gather.

Grill

IN CASE OF POWER FAILURE DO NOT USE GRILL. VENTILATION SYSTEM WILL NOT OPERATE.

Air Shutter Adjustment

To adjust surface burner air shutter (some models)

Loosen fastening screw with a phillips screwdriver and rotate air shutter to increase or decrease the size of the air opening. As the shutter is turned observe change in flame appearance. Adjustment is satisfactory when a clearly defined, even blue flame results at the Hi flame setting. After adjustment, tighten screw.

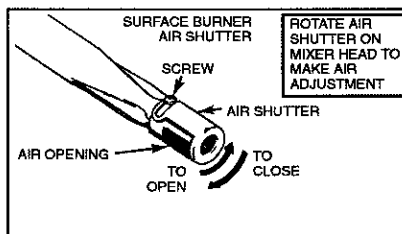

To adjust grill burner air shutters and surface burner air shutters (some models)

The left hand air shutter controls the rear half of the grill burner, or the rear surface burner. The right hand shutter controls the front half of the grill burner or the front surface burner.

Slide air shutter backward or forward to increase or decrease the size of the air opening. Air shutters fit snugly on the burner, so a screwdriver blade may be required to make this adjustment. Observe change in flame appearance as the air shutter is moved. Adjustment is satisfactory when a clearly defined, even blue flame results at the **Hi** flame setting. The snug fit of the air shutter assures it will remain positioned correctly.

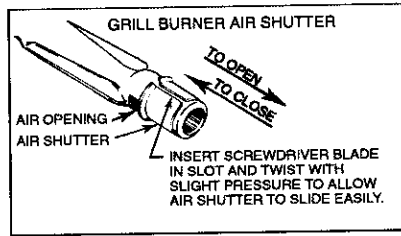

On any burner, closing the air shutter too far will cause the flame to become soft and yellow tipped. Opening the air shutter too wide will cause the flame to blow away from the burner ports. Proper adjustment will produce a sharp, clearly defined even, blue flame.

Lo Flame Adjustment

This appliance has been shipped from the factory with **Lo** and **Med** flame settings adjusted for use with natural gas and average installations. There is a wide variety of conditions caused by altitude and gas mixtures controlled by utility companies which will vary and affect the gas flame and performance. Adjustments should be made at time of installation. If conditions change, follow the procedures outlined below to adjust the **Lo** setting.

To adjust the Lo setting

1. Light burner and set control knob for low flame.
2. Remove control knob from valve stem.
CAUTION: Never use a metal blade to pry knob off. If knob cannot be easily removed tuck the folds of a cloth dishtowel under the knob skirt and pull the towel forward with steady, even pressure.
3. Insert a slender, thin-blade screwdriver into the recess at center of valve stem and engage blade with slot in adjusting screw.
4. Turn center stem adjusting screw slightly to set flame size. **Note:** Turn clockwise to reduce or counterclockwise to increase flame size.
5. Replace control knob when adjustment is completed.

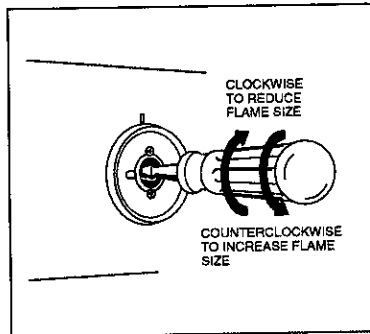

Proper adjustment will produce a stable, steady blue flame of minimum size. The final adjustment should be checked by turning knob from **Hi** to **Lo** several times without extinguishing the flame. This adjustment, at the **Lo** setting, will automatically provide the proper flame size at **Med** setting.

Cookware

Size of Cookware

To achieve optimum cooking performance use cookpots with flat bottoms and tight fitting covers. *Flame size should be adjusted so it does not extend beyond the edge of the cookware.* This instruction is based on safety considerations. Adjusting the size of the flame to fit the size of the cookware also helps to save fuel.

Important: Leave a minimum of 1½" between side of pan and surrounding surfaces, such as countertop backsplash or side walls, to allow heat to escape to avoid possible damage to these areas.

Cookware Materials

- Aluminum cookware heats evenly and quickly. A slightly larger flame size can be used. The flame can be adjusted so it comes to the edge of the cookware. However, the flame should NEVER be adjusted so that it extends beyond the bottom of the cookware.
- Stainless steel cookware with copper or aluminum cores heat evenly and fairly quickly. The flame size should be adjusted to extend only halfway between center and edge of the cookware bottom for best results.
- Cast iron cookware heats slowly.
- Check manufacturer's recommendations before using porcelain on steel, porcelain on cast iron, glass, glass-ceramic, earthenware, or other glazed cookpots.

Covered Cookware

If the cookware is covered, less fuel will be needed. Therefore, a lower flame size can be used.

Note: Food will not cook any faster when more than the amount of heat needed to maintain a gentle boil is used.

Surface Controls

To Set Controls

- Since the controls are a push-turn type, they must be pushed in before turning. To set (from the **Off** position), push in on control knob and immediately turn counterclockwise to the **Lite** position until burner ignites. After ignition, turn knob clockwise to desired setting.
- Igniter will continue to spark until knob is turned clockwise back to or past **HI** position on knob.

Control Locations

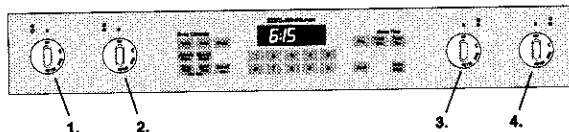

1. Left rear surface burner or grill
2. Left front surface burner or grill
3. Right rear surface burner
4. Right front surface burner

Note: When using an AG202 surface burner assembly with control locations #1 and #2, the control knob may be turned to a position lower than the **Lo** setting. (The **Lo** setting is set for the grill burner.)

Suggested Control Settings

The controls offer flexibility in heat setting selection. An infinite number of settings exist between **Hi** and **Lo**. At the **Hi** setting, a detent may be felt. For all settings other than **Hi**, simply adjust your flame for best results.

The size and type of cookware and the amount and type of food being cooked will influence the setting needed for best results. Suggested settings are provided as guidelines.

- Hi:** A fast heat to start cooking quickly, to bring liquids to a boil, to preheat oil for deep fat frying.
- (Med. High)** For fast frying or browning of foods, to maintain rapid boil of large amounts of food, to maintain oil temperature for deep fat frying.
- Med:** For most frying, sautéing, and slow boil of large amounts of food.
- (Med. Lo)** For simmering, maintaining boil of small amounts of food.
- Lo:** Maintaining serving temperature of foods, melting butter or chocolate.

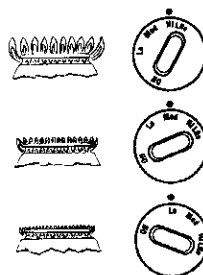

Surface Burner Module

Installation

The surface burner module consists of two surface burner grates, an aeration tray and a burner assembly.

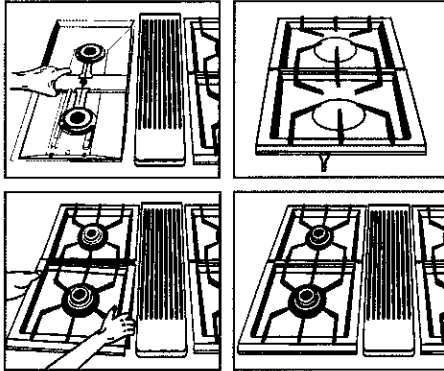

To Install Burner Module

1. Be sure control knobs are turned **Off**.
2. If the grill burner and grill grates are in place, remove before installing a surface burner module. Clean burner basin of any grease accumulation. (See page 21 for cleaning recommendations.)
3. Position the burner assembly with the mixer tube openings toward the orifices. Slide the burner assembly toward the orifices until opening for igniter is over the igniter. Lower into place until side openings are resting on the burner supports and igniter is centered between the two flash tubes.
4. Install the aeration tray by inserting the prong at the end of the pan into the opening in the end of the burner basin. Lower the opposite end into the rangetop.

Note: Before first use, read the Surface Burner Grates Care instructions found on page 46.

To Remove Burner Module

1. Control knobs should be in the **Off** position and the rangetop should be cool.
2. Remove the aeration tray by lifting up the front end on the right side (back end on the left side) until the top clears the opening of the rangetop by about 5 inches.
3. Hold aeration tray by the sides and slide away to remove the prong from the opening and clear the surface burners.
4. Lift up on the sides of the surface burner assembly bracket about 2 inches. Slide away from the orifices.

NOTE: Optional surface burner assembly, Model AG202, can replace the grill burner assembly. Model AG202 air shutters have been adjusted for compatibility on the left side.

NOTE: Do not disassemble the surface burner assembly.

Grilling

Installation

The grill consists of two black grill grates and a grill burner. Only install the grill on the left side of your range.

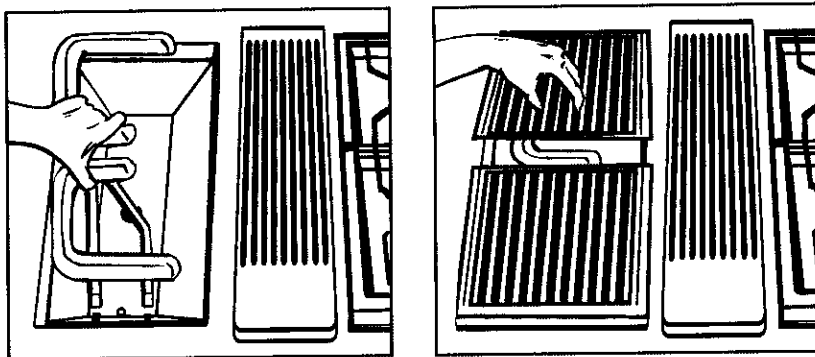

To Install Grill Module

1. Before installing grill components, be certain control knobs are in the **Off** position.
2. Position the grill burner with mixer tube openings toward the orifices. Slide the burner towards the orifices until the igniter is in between front and rear grill sections. Lower into place until side openings are resting on the burner support pins.
3. Place the grill grates on the top of the rangetop.

NOTE: Before using the grill for the first time, heat the E-ven Heat™ grill burner to remove the protective shipping coating. Heat the grill on **Hi** for 10 minutes and use the vent system to remove any additional smoke during cooling.

To Remove Grill Module

1. Be sure control knobs are in the **Off** position. Remove grill components once they are cool.
2. Remove grill grates.
3. Lift the grill burner up off the support pins about 2 inches. Slide the burner away from the orifices.

Using the Grill

- Before the first use, wash your new grill grates in hot soapy water, rinse and dry. Then "season" the surface by wiping on a thin coating of cooking oil. Remove excess oil by wiping again with another paper towel. This procedure should be repeated when: a) cleaning in the dishwasher since the detergent may remove seasoning, or b) anytime a sugar-based marinade (for example, barbecue sauce) is going to be used.
- Use nonmetallic spatulas or utensils to prevent damaging the Excalibur® nonstick grill grate finish.
- Preheat the grill on **Hi** for 5 minutes. Preheating improves the flavor and appearance of meats and quickly sears the meat to help retain the juices.
- *Excessive amounts of fat should be trimmed from meats.* Some fat is necessary to produce the smoke needed for that smoked, "outdoor" flavor. However, excessive fat can create cleaning and flare-up problems.
- *Allowing excessive amounts of grease or drippings to constantly flame voids the warranty on the grill grates.* Excessive flare-ups indicate that either the grill interior needs to be cleaned or that excessive amounts of fat are in the meat or the meat was not properly trimmed.
- Grease drippings will occasionally ignite to produce harmless puffs of flame for a second or two. This is a normal part of the cooking process.
- **NEVER LEAVE GRILL UNATTENDED DURING GRILL OPERATION.**

Should excess grease cause sustained flare-up

1. Turn on FAN manually.
2. Immediately turn grill control knobs to **Off** position.
3. Remove meat from grill.

IMPORTANT

- Do not use aluminum foil inside the grill area.
- Do not use charcoal or wood chips in the grill area.
- Do not allow burner basin to become overloaded with grease. Clean after each use.
- Do not cover grates completely with meat. Leave air space between each steak, etc. to allow proper ventilation as well as prevent flare-ups.

Grill Guide

Preheat grill on **Hi**, 5 minutes, for best flavor.

Type	Setting	Cooking Time	Procedure
Steak (½ - ¾") Rare Medium Well	Hi Hi Hi	6 to 10 minutes 10 to 16 minutes 21 to 24 minutes	Turn after 3 to 5 minutes. Turn after 5 to 8 minutes. Turn after 6 to 12 minutes.
Steak (1 - 1¼") Rare Medium Well	Hi Hi Hi	14 to 24 minutes 16 to 30 minutes 24 to 34 minutes	Turn after 7 to 12 minutes. Turn after 9 to 15 minutes. Turn after 12 to 17 minutes.
Hamburgers (3-4 oz.)	Med	20 to 25 minutes	Turn after half the time.
Pork Chops Fully-cooked Smoked Pork Chops Ham Slices	Med Med Med	20 to 30 minutes 10 to 15 minutes 15 to 20 minutes	Turn occasionally. Turn once. Glaze if desired. Turn after half the time.
Fully-cooked sausages Hot Dogs, Brats Polish	Hi Hi	7 to 12 minutes 13 to 16 minutes	Turn once. Turn occasionally.
Fresh Sausage Links Patties (3" diameter) Italian Sausage	Med Med Med	15 to 25 minutes 15 to 20 minutes 25 to 30 minutes	Turn occasionally. Turn after half the time. Pierce casing with a fork. Turn once.
Chicken Pieces: Bone-in Boneless Breasts	Med Med	35 to 50 minutes 25 to 35 minutes	Turn occasionally. Turn occasionally.
Fish Steaks (1") Filets (½") (with skin on) Shrimp (skewered)	Med Med Med	20 to 25 minutes 10 to 15 minutes 10 to 20 minutes	Brush with butter. Turn after half the time. Start skin side down. Brush with butter. Turn after half the time. Turn and brush with butter or marinade frequently.
Garlic Bread Hot Dog Buns and Hamburger Buns	Med Med	4 to 6 minutes 1 to 2 minutes	Turn after half the time.

Note: This chart is a suggested guide. Cooking times and control settings are approximate due to variations in meats and gas pressure.

Grilling Tips

With your Jenn-Air grill literally any food you've considered "at its best" when prepared outdoors can now be prepared indoors with less fuss and great flavor.

The following suggestions are good rules to follow and will increase your enjoyment of the equipment.

- Be sure to follow directions on page 18 for using the grill.
- Suggested cooking times and control settings are approximate due to variations in meats. Experience will quickly indicate cooking times as well as which settings work best.
- For best results, buy top grade meat. Meat that is at least $\frac{3}{4}$ inch will grill better than thinner cuts.
- Score fat on edges of steak, but do not cut into meat, to prevent curling while cooking.
- For the attractive "branded" look on steaks, be sure grill is preheated. Allow one side of meat to cook to desired doneness, or until juices appear on the top surface, before turning. Turn steaks and hamburgers just once. Manipulating food causes loss of juices.
- When basting meats or applying sauces to foods, remember that excessive amounts wind up inside your grill and do not improve the food flavor. Apply sauces during the last 15 to 20 minutes of cooking time unless recipe specifies otherwise. Plus, any time a sugar-based marinade, (for example, barbecue sauce) is going to be used, the grates should be "seasoned" prior to preheating. (See p. 18.)
- There are many meat marinades which will help tenderize less expensive cuts of meat for cooking on the grill.
- Certain foods, such as poultry and non-oily fish, may need some extra fat. Brush with oil or melted butter occasionally while grilling.
- Use tongs with long handles or spatulas for turning meats. Do not use forks as these pierce the meat, allowing juices to be lost.
- To help retain meat juices, salt after turning meat or after cooking is completed.

Cleaning the Grill

Be sure the grill is cool and controls are **Off**.

Grill Grates

These are made from cast aluminum and are coated with the Excalibur® nonstick finish.

- After the grill grates have cooled, wipe off grates with a paper towel. Wash cool grates (**DO NOT IMMERSE HOT GRILL GRATES IN WATER**) with soap or detergent in hot water in the sink or wash them in the dishwasher. Be sure to remove all food residue before cooking on the grill grates again.
- Remove stubborn spots with a plastic mesh puff or pad. For best results, use only those cleaning products which state they are recommended for use when **cleaning nonstick surfaces**.
- If grates are washed in the dishwasher, season with oil prior to grilling. (See p. 18.)
- *Do not use metal brushes or abrasive scouring pads or other scrubbers intended to clean outdoor charcoal grills.* These will remove the finish as well as scratch the grates. *Do not clean in the self-cleaning oven or use oven cleaners on the grates.*

Grill Burner

Follow instructions on page 17 for removing the grill burner. *The grill burner should be cleaned after each use.* It can be cleaned with a soapy S.O.S. pad or in the dishwasher. Rinse and dry thoroughly before using again. For heavy soil, burner should be cleaned first with a soapy S.O.S. pad, rinsed and dried. Then it can be cleaned in a self-clean oven for 2 hours.

NOTE: Check to be sure all burner ports are open. To open clogged ports, insert a toothpick directly into each port.

Porcelain Burner Basin

This area located under the grill and surface burners. Clean after each use of the grill.

- To remove light soil, clean with soapy water or with cleansers such as Fantastik or 409. For easier cleanup: a) spray with a household cleanser; b) cover with paper towels; c) add small amount of water to keep the paper towels moist; d) cover and wait 15 minutes; and e) wipe clean.
- To remove moderate soil, scrub with Comet, Bon Ami, a soft scrub cleanser or plastic scrubber.
- To remove stubborn soil, spray with an oven cleaner, let soak overnight, wipe clean, rinse and dry.

Note: Clean the grease drain after each use. To clean: Pour about $\frac{1}{3}$ cup of very hot tap water mixed with 1 teaspoon dish detergent down the drain. In the event the drain is clogged, due to large food particles being trapped, use the nylon string that was packaged with your range. To use the nylon string, simply insert one end into the drain opening in the basin pan. Feed the nylon string down until it is visible under the range. Now pull up on the end extending out from the top while holding a paper towel around the string, to clean the string as it is being pulled. This should free any trapped particles of food. Pour another $\frac{1}{3}$ cup of very hot water mixed with dish detergent to assure the drain is opened and clear.

Grease Container

The container is located on the left side behind the bottom access panel, underneath the range. (See page 48 for opening access panel.) It collects grease and other liquids created while grilling or using some of the accessories. Check each time after grilling and empty when grease is noticeable. To remove, simply grasp the handle, and pull from the bracket holding the container.

- Check the container periodically to prevent grease from spilling over. If this should happen, the grease will flow over the container and onto the floor. The container and screw-on handle can be washed in hot, soapy water or in the dishwasher. The container can be replaced with any heat tempered jar, such as a canning jar, which has a standard screw neck.

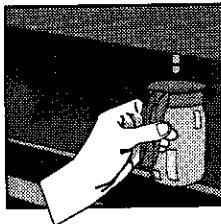

Oven Operation

Oven Control Panel

The control panel is designed for ease in programming. The Display Window features Indicator Words which will flash to prompt you for the next step.

To program

1. Touch the function pad to give command desired.
2. Touch the appropriate number pads to enter time or temperature.
Note: Five seconds after entering the number, the time or temperature will automatically be entered. If more than five seconds elapse between touching a function pad and touching a number pad, the control is not set and Display will return to previous Display.



Function Pads

- | | |
|--|--|
| | Use for conventional baking or roasting. |
| | Use for top browning or oven broiling. |
| | Use to set self-cleaning process. |
| | Use for convection roasting. |
| | Use for convection baking. |
| | Use for clock controlled cooking and cleaning when delayed start is desired.
(For lock function see page 47.) |
| | Use for clock controlled cooking.
(For lock function see page 47.) |
| | Cancel all programming except Timer. |
| | Use to turn the Ventilation System on or off. (See p. 10.) |
| | Use to signal expiration of a time period up to 11 hours and 55 minutes. |
| | Use to signal expiration of a time period up to 11 hours and 55 minutes. |
| | Use to set time of day. |
| | Use to turn oven light on and off. |

Number Pads

Use to set time or temperature.

Oven Light Pad (Control Panel)

The oven light automatically comes on whenever the oven door is opened. When door is closed, touch the **Oven Light Pad** to turn oven light on or off. **Note:** A beep will sound every time the **Oven Light Pad** is touched.

Display Window

Shows time of day, timer, and oven functions.

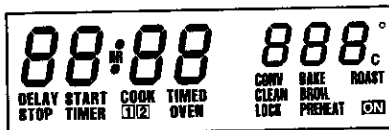

Display Numbers:

- Show time of day.
- Countdown of time remaining when using time functions.
- Show temperature of oven as it rises to reach programmed temperature and the set temperature once it is reached.
- Recall programmed temperature or time when commanded.
- Rounding of Display Numbers: Temperature range is 100° to 550°F and can be set in 5° increments. When setting temperature, the control will round it to the nearest 10°. For example, if 237° is entered, the control will round the temperature to 240°.

Prompts:

- Serve as a reminder to shut oven door, if it is open, for self-cleaning operation when the word, *door*, is displayed.
- "Err" will appear in the Display when an improper temperature or time has been entered. "Err" will flash and a beep will be heard three times. Then, the Display will return to the previous Display before the error was entered.

Indicator Words:

- Flash to prompt next step.
- Indicate status of programmed function.
- Show programmed function when recalled.

Chimes vs. Beeps

- A chime sound is used to designate the end of a timing or cooking operation.
- A beep sound will be heard when any pad is touched. A series of short beeps are used to designate an incorrect entry, door is open when set for a self-clean and a fault code.

End of Cycle Chimes:

- The end of cycle chimes is four short chimes followed by "reminder" chimes for a specified length of time, until you cancel that function. For the Timer function, there are two "reminder" chimes every thirty seconds for five minutes. For the Timed Cook functions, there is one "reminder" chime every minute for ten minutes. To cancel these "reminder" chimes, touch the appropriate pad again (the **Timer Pad** or **Cook Time Pad**). You may also touch the **Cancel Off Pad** to cancel the "reminder" chimes, but it will also cancel all other oven functions.
- If you would like to eliminate the "reminder" chimes entirely, touch and hold the **Cancel Off Pad** for twelve seconds (this will not eliminate the initial four short chimes).
- To return the "reminder" chimes, touch and hold the **Cancel Off Pad** for twelve seconds.

NOTE: To change the oven to a 24 hour clock or Celsius (C) degrees, contact your authorized Jenn-Air service contractor or installer.

Setting Controls

BASIC INSTRUCTIONS

1. Position oven racks.
2. Touch **Bake Pad** or **Convect Bake Pad**, or **Convect Roast Pad**.
3. Touch the appropriate number pads for desired temperature.

To set oven on Bake or Convect Bake or Convect Roast

1. Place oven racks on proper rack positions. (See p. 25.)
2. Touch **Bake Pad** or **Convect Bake Pad** or **Convect Roast Pad**.
Indicator Words **BAKE** or **CONV BAKE** or **CONV ROAST** will flash and three dashes will be shown.
Note: If more than five seconds elapse between touching a pad and touching a number pad, Display will return to previous Display.
3. Touch the appropriate number pads for desired oven temperature.
(Allowable range is 100° to 550°F). After five seconds the oven will begin to preheat. The Indicator Words **ON**, **PREHEAT**, and either **BAKE** or **CONV BAKE** or **CONV ROAST** will appear in the Display. The temperature shown will be 100° or the oven temperature whichever is higher.

Example: If at 10 o'clock you set the oven for 350° for convect baking, after five seconds the Display will show:

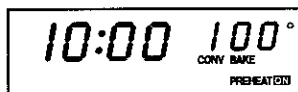

During the preheat, the Display will show a rise in 5° increments until programmed temperature is reached. When the oven is preheated, the oven will chime, the **ON** and **PREHEAT** Indicator Words will go off, and the programmed oven temperature will remain in the Display.

Note: Oven will preheat for approximately 7 to 11 minutes.

Important: Whenever **ON** appears in the Display, the oven is heating.

To recall temperature set during preheat: Touch the appropriate **Bake Pad** or **Convect Bake Pad** or **Convect Roast Pad**. Temperature will be briefly displayed, then will automatically return to on-going program.

To change temperature set: Touch appropriate **Bake Pad** or **Convect Bake Pad** or **Convect Roast Pad** and the appropriate number pads for the new desired temperature.

Note: If you are lowering the temperature below the current oven temperature, the Indicator Words **ON** and **PREHEAT** will appear briefly in the Display and the preheat chime will sound. Then, the Display will show programmed temperature and Indicator Word **BAKE** or **CONV BAKE** or **CONV ROAST** only.

4. Touch **Cancel Off Pad** to turn oven off at end of baking. The oven will continue operating until the **Cancel Off Pad** is touched.

Rack Positions

The rack positions noted are generally recommended for the best browning results and most efficient cooking times. For many food items, excellent results can be achieved *when using one of several different rack positions*. Refer to baking and roasting sections for recommendations for specific foods.

Different Racks

Two flat racks and one offset rack are packaged with your oven. The use of the offset rack is denoted in the list below and the charts as an "o" after the rack number.

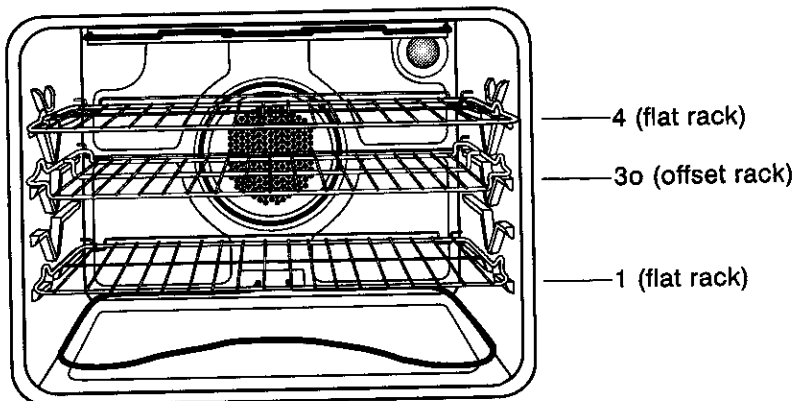

Rack Uses

Rack Position #4o (offset rack on #4):

Most broiling.

Rack Position #3:

Most baked goods on cookie sheets, cakes (sheet and layer).

Rack Position #3o (offset rack on #3):

Most baked goods on cookie sheets, frozen convenience foods, fresh fruit pie, cream pie, layer cakes, main dish souffle.

Rack Position #2:

Roasting small cuts of meat, cakes (tube, bundt or layer), frozen fruit pie, pie shell, large casseroles.

Rack Position #2o (offset rack on #2):

Roasting small cuts of meat, loaves of bread, angel food cake.

Rack Position #1:

Large cuts of meat and large poultry, angel food cake, loaves of bread, custard pie, dessert souffle.

Multiple Rack Cooking:

Two racks, use #2o and #4. Three racks, use #1, #3o, and #4.

Clock Controls

Time of Day Clock

When electrical power is supplied or after power interruption, the last clock time displayed before power was interrupted will flash. Time will advance and continue to flash until clock is reset.

BASIC INSTRUCTIONS

1. Touch **Clock Pad**.
2. Touch appropriate number pads.

To set Time of Day

1. Touch **Clock Pad**.

Indicator word TIME will flash and time digits will appear in the Display. (If more than five seconds elapse between touching **Clock Pad** and touching a number pad, the **Clock Pad** must be touched again in order to set clock.)

2. Touch the appropriate number pads until correct time of day appears in the Display.

Note: Five seconds after touching the number pads, the time of day will automatically be entered.

IMPORTANT

- To recall time of day when another time function is showing: Touch **Clock Pad**.
- To change time of day set on the clock: Repeat steps 1 and 2 above.
- Clock time cannot be changed when oven has been programmed for Timed Bake, Timed Convection Bake, Timed Convection Roast or Self-clean. Cancel program before reprogramming clock.

Timer

Important: This interval Timer can be used to remind you when a period, up to 11 hours and 55 minutes, expires. It can be used independently of any other oven activity and can be set while another oven function is operating. The Timer does not control the oven.

BASIC INSTRUCTIONS

1. Touch a **Timer Pad**.
2. Touch the appropriate number pads.

To set Timer

1. Touch a **Timer Pad**.

The Indicator Word **TIMER** and either 1 or 2 flashes and "0Hr:00" appears in the Display.

2. Touch the appropriate number pads until the desired number of minutes or hours and minutes appear in the Display.

Note: If more than five seconds elapse between touching a **Timer Pad** and a number pad, the **Timer Pad** must be touched again.

Example: To set Timer One for 5 minutes, touch the **Timer One Pad** and the number pad "5". After five seconds, the Display will show:

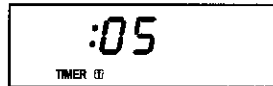

Example: To set Timer Two for 1 hour and 30 minutes, touch the **Timer Two Pad** and the number pads "1, 3, 0". After five seconds, the Display will show:

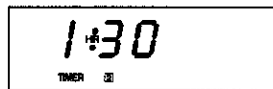

Countdown will start after five seconds. Countdown will have display precedence over other time functions. If both timers are set, the timer with the least amount of time remaining will have display precedence.

At the end of time set, the Timer will chime four times and "End" will appear in the Display. If the Timer is not cancelled (see below), "End" will remain in the Display and there will be two chimes every thirty seconds for five minutes.

To cancel Timer

1. Touch and hold the **Timer Pad** for four seconds.
OR
2. **A.** Touch the **Timer Pad**.
B. Touch "0" number pad. Five seconds later the Timer will be cancelled.

NOTE: Touching **Cancel Off Pad** to cancel chimes will cancel **ALL** selected oven programming.

Clock Controlled Baking or Roasting

BASIC INSTRUCTIONS

1. Touch **Bake Pad** or **Convect Bake Pad** or **Convect Roast Pad**.
2. Touch the appropriate number pads for desired temperature.
3. Touch **Cook Time Pad**.
4. Touch the appropriate number pads to enter cooking hours & minutes.
5. Touch **Stop Time Pad**.*
6. Touch the appropriate number pads to enter **Stop Time**.*

*Omit steps 5 & 6 if you want baking to start immediately.

To set oven to start immediately and shut off automatically

1. Touch **Bake Pad** or **Convect Bake Pad** or **Convect Roast Pad**.
Indicator Words **BAKE** or **CONV BAKE** or **CONV ROAST** will flash and three dashes will be shown.
2. Touch the appropriate number pads for desired oven temperature.
After five seconds the oven will begin to preheat. The Indicator Words **ON**, **PREHEAT**, and **BAKE** or **CONV BAKE** or **CONV ROAST** will appear in the Display. The temperature shown will be 100° or the temperature of the oven, whichever is higher. **Example:** If at 10 o'clock you set the oven for 350° for convection baking, the Display will show:

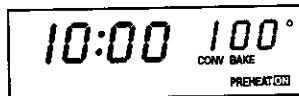

During the preheat, the Display will show a rise in 5° increments until programmed temperature is reached. When the oven is preheated, the oven will beep, the **ON** and **PREHEAT** Indicator Words will go off, and programmed oven temperature will be displayed. **Important:** Whenever **ON** appears in the Display, the oven is heating.

3. Touch **Cook Time Pad**.
Indicator Words **COOK TIME** will flash and Display will show "0 HR:00".
4. Touch the appropriate number pads to enter cooking hours in five minute increments. Hours are to left of colon and minutes to right of colon. (Allowable range is 5 minutes to 11 hours and 55 minutes.) **Example:** If cooking time selected for the oven is 2 hours and 30 minutes, the Display will show:



After five seconds, the time of day returns to the Display.

Important: Oven will preheat for approximately 7 to 11 minutes. At end of programmed Cook Time, oven will shut off automatically and retained heat will continue to cook the food. Clock controlled cooking is not recommended for baked items that require a preheated oven, such as cakes, cookies, pies, breads. For these foods, place food in preheated oven, then use Timer to signal end of baking time.

At the end of programmed Cook Time, the oven will shut off automatically and a chime will be heard four times and "End" will appear in the Display. If oven is not cancelled, "End" will remain in the Display and there will be one chime every minute for ten minutes.

To set oven to start at future time and shut off automatically

1-4. Follow preceding Steps 1-4 on page 28.

5. Touch **Stop Time Pad**.

Indicator Words STOP and TIME will flash. Display will show the calculated stop time based on current time of day and cook time.

6. Touch the appropriate number pads to enter desired stop time.

A stop time can only be accepted for later in the day. **Note:** Since food continues to cook if left in the oven, it is suggested that the clock controls be used primarily to start the oven when no one is in the kitchen. Provisions should be made to have the food removed as soon as the chime has sounded.

Example: If at 10 o'clock you set the oven for 350° convection baking and 2 hours and 30 minutes cooking time, the calculated stop time would be "12:30". The Display would show:

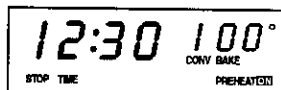

If you want the stop time to be 1 o'clock, touch the number pads "1,0,0". Five seconds later, the Display will briefly show the start time:

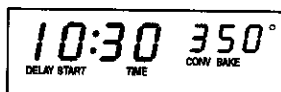

After five seconds, the Display will return to current time of day, thus showing:



At the end of the delayed period, the DELAY Indicator Word will go off and the oven will begin to heat. 100° will be shown. As the oven heats, the Display will show a rise in increments of 5° until programmed temperature is reached.

At the end of programmed Cook Time, the oven will shut off automatically and a chime will be heard four times and "End" will appear in the Display. If oven is not cancelled, "End" will remain in the Display and there will be one chime every minute for ten minutes.

IMPORTANT

- **To recall time function programmed:** Touch the appropriate time pad.
- **To cancel timed function only:** Hold **Cook Time Pad** for four seconds. This will only cancel cook time and stop time, not programmed bake mode.
- If more than five seconds elapse between touching a function pad and touching appropriate number pads, the oven is not set and Display will return to previous Display.

Baking

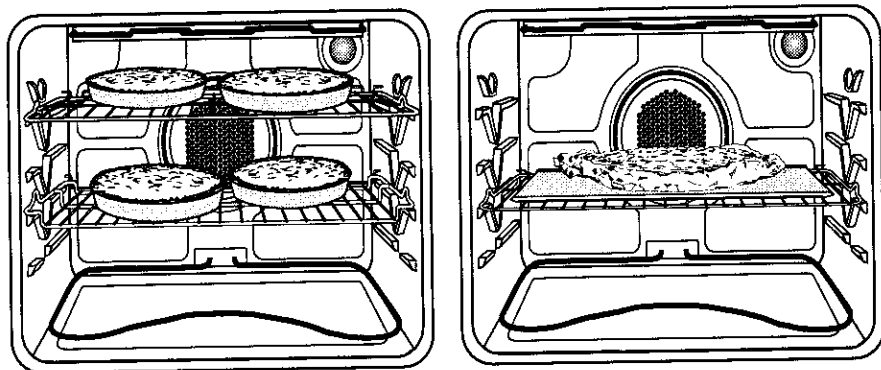

General Baking Recommendations

- When cooking foods for the first time in your new oven, use recipe cooking times and temperatures as a guide.
- Use tested recipes from reliable sources.
- Preheat the oven only when necessary. For baked foods that rise and for richer browning, a preheated oven is better. Casseroles can be started in a cold oven. Preheating takes from 7 to 11 minutes; place food in oven after PREHEAT Indicator Word cycles off.
- Arrange oven racks before turning on oven. Follow suggested rack positions on pages 25 and 31.
- Allow about 1 to 1½ inches of space between the oven side walls and pans to allow proper air circulation.
- When baking foods in more than one pan, place them on opposite corners of the rack. *Stagger pans* when baking on two racks so that one pan does not shield another unless shielding is intended. (See above left.)
- To conserve energy, avoid frequent or prolonged door openings. At the end of cooking, turn oven off before removing food.
- Always test for doneness (fingertip, toothpick, sides pulling away from pan). Do not rely on time or brownness as only indicators.
- Use good quality baking pans and the size recommended in the recipe.
- Dull, dark, enameled or glass pans will generally produce a brown, crisp crust. Shiny metal pans produce a light, golden crust.
- Frozen pies in shiny aluminum pans should be baked on a cookie sheet on rack 2 or be removed to a dull or glass pan.
- If edge of pie crust browns too quickly, fold a strip of foil around rim of crust, covering edge. (See above right.)

Baking Chart

For Conventional Bake use the **Bake Pad**.

Product and Type	Pan Size	Rack Position*	Convect Bake		Conventional Bake	
			Temp. (°F) Preheated***	Time**	Temp. (°F) Preheated	Time**
CAKE						
Yellow - 2 layers	9"	3o or 3	325°	22-30	350°	28-33
White - 2 layers	9"	3o or 3	325°	22-30	350°	25-30
Chocolate - 2 layers	9"	3o or 3	325°	25-30	350°	30-35
Angel Food tube		2o or 2	350°	30-35	375°	30-40
Pound Cake	9x5 loaf	2	300°	50-60	325°	55-65
Cupcakes	2 pans	2o & 4	325°	15-20	350°	15-25
Sheet Cake	9x13"	3 or 3o	325°	26-31	350°	30-40
PIES						
Two Crust						
Fruit, fresh	9"	3o	350°-400°	45-60	375°-425°	45-60
Fruit, frozen	9"	2	350°-400°	40-65	375°-425°	40-65
One Crust						
Custard, fresh	9"	1	325°-375°	40-50	350°-400°	40-60
Meringue	9"	3o	325°-375°	7-11	350°-400°	8-12
Pie Shell	9"	2	425°	7-11	450°	8-12
COOKIES						
Chocolate Chip		3o or 3	325°-350°	6-10	350°-375°	7-11
Peanut Butter		3o or 3	325°-350°	6-10	350°-375°	7-11
Sugar		3o or 3	325°-375°	6-10	350°-400°	7-11
Brownies	9x13"	3o	325°	20-26	350°	25-31
BREADS, YEAST						
Loaf	9x5 loaf	1 or 2o	350°	17-23	375°	18-28
Rolls		3o	350°-375°	9-14	375°-400°	12-15
BREADS, QUICK						
Loaf, Nut, Fruit	8x4 loaf	2o	325°-350°	40-55	350°-375°	50-65
Gingerbread	9x9"	3o	325°	22-28	350°	25-35
Corbread	8x8"	3o	375°-425°	13-28	400°-450°	15-30
Corbread Muffins		3o	350°-375°	8-15	375°-400°	10-20
Biscuits		3 or 3o	375°-400°	7-11	400°-425°	8-15
Muffins		3o	350°-400°	15-20	375°-425°	15-25

* An "o" after a rack number implies that the offset rack should be used.

** The times given are based on specific brands of mixes or recipes tested. Actual times will depend on the ones you bake.

*** The Convect Bake temperature is 25°F lower than recommended on package mix or recipe.

Causes of Cake Failure

Problem	Possible Cause
Cake Falls	Oven not hot enough Insufficient baking Opening oven door during baking Too much or too little leavening, liquid or sugar
Peaks in center or cracks on top	Oven too hot at start of baking or overbaking Pan size too small Too little or too much flour or leavening Overmixing
Flat Cake	Pan too large Overmixing or undermixing Too much or too little liquid Old or too little baking powder
Uneven cakes	Range not level Batter uneven Cake pans too close to oven walls or each other
Sticks to pan	Cake cooled in pan too long Pan not greased and floured
Cracks and falls apart	Removed from pan too soon Too much shortening, leavening or sugar
Excessive shrinkage from sides of pan	Oven too hot or overbaking Overmixing

Convection Baking Recommendations

- Use convection baking for breads, cakes, cookies and pies.
- As a general rule, when using recipes or prepared mixes developed for a conventional bake oven, set the oven temperature 25°F lower than the recipe recommended temperature. Times will be similar to or a few minutes less than recipe recommended times. The chart on page 31 compares times and temperatures of many baked foods. Use this as a reference.
- For better browning, place cookie sheets and baking pans lengthwise, side to side on the rack.
- Cookie sheets should be without sides and made of shiny aluminum. The best size to use for cookie sheets is 16" x 12" or smaller.

Convect Cooking on Multiple Racks

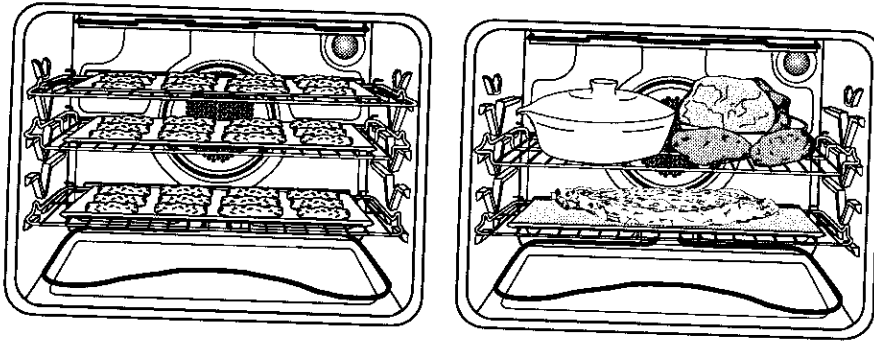

For best results, bake foods on one rack at a time as described in this manual. However, very good results can be obtained when baking quantities of foods on multiple racks. Quantity cooking provides both time and energy savings.

Convect Bake is suggested for most multiple rack cooking, especially three rack cooking, because the circulating heated air results in more even browning. For two rack cooking, the conventional bake oven provides very good baking results especially when pans can be staggered, such as with layer cakes and fresh pies.

Many foods can be prepared on three racks at the same time. These are just a few examples: cookies, cupcakes, rolls, biscuits, muffins, pies, pizzas, appetizers, and snack foods.

To obtain the best results in multiple rack cooking, follow these suggestions:

- Use temperature and times in this manual as a guide for best results.
- For two rack baking, rack positions #2 and 4 are best for most baked products but positions #1 and 3 also provide acceptable results.
- For three rack baking use positions #1, 3 and 4. One exception is pizza. (See p. 37.)
- Since foods on positions #1 and 4 will usually be done before foods on position #3, additional cooking time will be needed for browning foods on the middle rack. An additional minute is needed for thin foods such as cookies. For foods such as biscuits, rolls, or muffins, allow 1 to 2 more minutes. Frozen pies and pizzas, which should be baked on a cookie sheet, need about 2 to 4 more minutes.
- Stagger small pans, such as layer cake pans, in the oven.
- Frozen pies in shiny aluminum pans should be placed on cookie sheets and baked on rack positions #1, 3 and 4.
- Cookie sheets should be placed *lengthwise, side to side*, in front of the fan for more even browning.
- Oven meals are recommended for energy conservation. Use rack positions #1 and 3 or #2 and 4 and **Convect Roast**.

Roasting

General Roasting Recommendations

- *Preheating is not necessary.*
- For open pan roasting, place meat or poultry on the slotted portion of the two-piece pan included with the oven. Do not add water to the pan. Use open pan roasting for tender cuts of meat. Less tender cuts of meat need to be cooked by moist heat in a covered pan.
- For best results, a meat thermometer is the most accurate guide to degree of doneness. The tip of the thermometer should be located in the thickest part of a roast, not touching fat, bone, or gristle. For turkeys and large poultry products, insert the tip of the thermometer into the thickest part of the inner thigh.
- Place roast fat side up to allow self basting of meat during roasting.
- Since meats continue to cook after being removed from the oven, remove roast from oven when it reaches an internal temperature about 5 degrees below the temperature desired.
- For less loss of juices and easier carving, allow about 15 minutes "standing time" after removing meat from oven.
- For best results in roasting poultry, thaw completely. Due to the structure of poultry, partially thawed poultry will cook unevenly.

Conventional Roasting Recommendations Using Bake Pad

- If preferred, tender cuts of meat can be roasted in the conventional bake oven by following the general recommendations given above. However, meats will roast more quickly in the convect oven using **Convect Roast**.
- Conventional bake is best for less tender cuts of meat that require a longer, moist heat method of cooking. Follow your recipe for times and temperatures for covered meats.
- Meats cooked in oven cooking bags, dutch ovens, or covered roasting pans are best cooked in the conventional bake oven using the **Bake Pad**.
- Use meat roasting charts in standard cookbooks for recommended times and temperatures for roasting in a conventional bake oven.

Roasting Chart

Chart time is based on thawed meats only. For Conventional Roasting use the **Bake Pad**.

Variety and Cut of Meat	Approx. Weight (lb)	Oven Temp (°F) no preheat*	Internal Temp of Meat - End of Roasting Time (°F)	Approx. Convection Roasting Time (minutes per lb)	Approx. Conventional Roasting Time (minutes per lb.)
BEEF					
Rib Roast	4 to 8	325°	145° (rare) 160° (medium)	25-30 30-35	30-35 35-40
Rib Eye Roast	4 to 6	325°	145° (rare) 160° (medium)	25-30 30-35	30-35 35-40
Tenderloin Roast	2 to 3	400°	145° (rare)	18-23	23-28
Eye of Round Roast	4 to 5	325°	145° (rare) 160° (medium)	25-30 30-35	30-35 35-40
Top Loin Roast	3 to 6	325°	145° (rare) 160° (medium)	25-30 30-35	30-35 35-40
Round Tip Roast	4 to 6	325°	145° (rare) 160° (medium)	25-30 30-35	30-35 35-40
PORK					
Shoulder Blade Roast Boneless	4 to 6	325°	170°	30-40	35-45
Shoulder Blade Roast	4 to 6	325°	170°	25-35	30-40
Top Loin, boneless	3 to 4	325°	170°	30-40	35-45
Ham, Half (Fully cooked)	5 to 7	325°	140°	NA**	25-35
Ham, Half (Cook before eating)	5 to 7	275°	160°	30-40	35-45
Arm Picnic Shoulder (Fully cooked)	5 to 8	325°	140°	20-25	25-30
POULTRY					
Turkey, unstuffed	8 to 12	325°	180°-185°	15-17	20-22
Turkey, unstuffed	12 to 16	325°	180°-185°	13-15	18-20
Turkey, unstuffed	16 to 20	325°	180°-185°	11-13	16-18
Turkey, unstuffed	20 to 24	325°	180°-185°	9-11	14-16
Turkey, Breast	3 to 8	325°	170°-175°	25-35	30-40
Chicken, Whole	2½ to 3½	375°	185°	19-23	22-26
Cornish Game Hen	1 to 1½	375°	180°-185°	35-45	45-55
Duck	4 to 6	350°	185°	15-20	20-25

* When using the Convection Roast mode, there is no need to preheat the oven or to lower the temperature from conventional roast temperatures.

** Not recommended for convection cooking. Most precooked hams have to be covered while roasting, thus there would be no time savings when using the convection mode.

Convect Roasting Recommendations

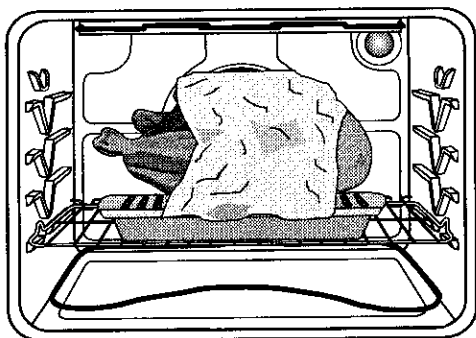

- Tender cuts of meat and poultry can be roasted to a rich golden brown in the convection oven. Follow general recommendations for roasting and use **Convect Roast**.
- Refer to convection meat roasting chart for recommended cooking temperature and time. The chart can serve as a guide to help plan meal serving time.
- Minutes per pound will vary according to the size, shape, quality, and initial temperature of meat as well as the electrical voltage in your area. Times are based on refrigerator cold meat.
- A large cut of meat will usually require fewer minutes per pound to roast than a smaller cut of meat.
- Do not use a roasting pan with high sides; use pan provided with oven.
- Do not cover meat. Allow the circulating hot air to surround the meat and seal in the juices.
- Since the breast meat on a large turkey cooks more quickly than the thigh area, place a "foil cap" over the breast area after desired brownness is reached to prevent overbrowning. (See above.)
- A stuffed turkey will require an extra 30 to 60 minutes, depending on size. Stuffing should reach an internal temperature of 165°F.

Convect Roasting: Frozen to Finish

Meats (except poultry) may be roasted frozen to finish. Follow these guidelines for the most satisfactory results.

- Use temperatures for roasting fresh meats as recommended by most cookbooks. Generally, most meats are roasted at 325°F. For best results do not use temperatures below 300°F.
- Use times for roasting *fresh* meats given in your favorite cookbooks as approximate guides for roasting *frozen* meats. Roasting times will vary due to factors such as coldness of meat, size, quality, or cut. In general, roasting times for frozen to finish in the convection oven will be approximately the same as fresh to finish in a conventional bake oven.
- The guidelines given for roasting fresh meats in the convection oven also apply to roasting frozen meats.
- Insert meat thermometer midway during the cooking process.

Convect Roasting of Frozen Convenience Foods

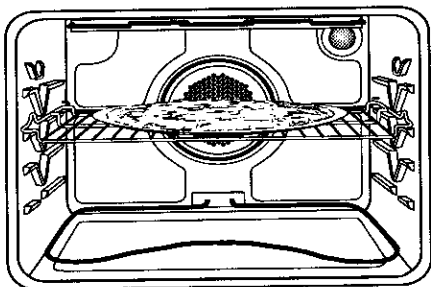

- Use the **Convect Roast Pad** for best results.
- *Preheating the oven is not necessary.*
- Follow package recommendations for oven temperature, foil covering and use of cookie sheets. Cooking times will be similar. See chart below for some exceptions and examples.
- Center foods in the oven. If more than one food item is being cooked or if foods are being cooked on multiple racks, stagger foods for proper air circulation.
- Most foods are cooked on rack position #3o.
- For multiple rack cooking, use racks #1, 3o and 4. However, pizzas should be placed on cookie sheets and baked on rack position #2o, 3 and 4.

Here are a few examples of times and temperatures

Frozen Convenience Foods	Rack Position*	CONVECT ROAST OVEN NOT PREHEATED		CONVENTIONAL BAKE** PREHEATED	
		Temp.° F	Minutes***	Temp.° F	Minutes***
Chicken, fried	3o	375°	40-45	375°	40-45
Fish, sticks	3	400°	13-18	400°	15-20
French fries	3	450°	20-25	450°	20-25
Pot Pies	3o	400°	30-35	400°	30-35
Pizza	3o	400°	12-15	400°	12-15

* An "o" after a rack number implies that the offset rack should be used.

** Conventional bake uses the **Bake Pad**.

*** The times given are based on specific brands of mixes or recipes tested. Actual times will depend on the ones you bake.

Note: Convect roasting times will be similar to the conventional times because the oven is not preheated. The time savings comes from not having to preheat the oven.

Broiling

BASIC INSTRUCTIONS

1. Position oven rack.
2. Touch **Broil Pad**.
3. Touch the appropriate number pad(s) to set temperature.

To Broil

1. Place oven rack on the rack position suggested in the chart on page 39. Distance from broiling element depends on foods being prepared. Rack position 4o (offset rack in position #4) is usually recommended unless otherwise stated.
2. Touch **Broil Pad**.
Indicator Word BROIL will flash and Display will show three dashes.

Note: If more than five seconds elapses between touching **Broil Pad** and touching a number pad, the oven is not set and Display will return to previous Display.

3. Touch the appropriate number pad(s).
The first number pad touched will enter "HI" in the Display.

The oven has a variable broil feature which means that a lower temperature can be selected. After "HI" appears in the Display, touch the appropriate number pads for the desired temperature. Temperature can be entered in 5° increments. Use "HI" broil for most broil operations. Use variable broil for delicate and long-term items.

Five seconds after entering "HI" or four seconds after entering a temperature, the broil element will come on and the Indicator Words BROIL and ON will remain in the Display. If the variable broil feature was selected, the Indicator Word ON will cycle with the element.

Example: If at 4 o'clock you set the oven for broil ("HI"), the Display will show:



4. Place food on broiler pan provided with oven. Broil element will preheat in 5 minutes. After broil element is red, place food in oven. Oven door MUST be left open at broil stop position.
5. Touch **Cancel Off Pad** to turn off oven when food is cooked.

NOTE: A fan comes on during the BROIL cycle. If it does not, the oven broil element will cycle on and off. If the fan does not operate, contact your authorized Jenn-Air Service Contractor for repair.

Broiling Tips

- Tender cuts of meat or marinated meats are best for broiling. This includes rib and loin cuts of steak, ground beef, ham steaks, poultry pieces or fish. For best results, steaks should be at least 1" thick. Thinner steaks should be pan-broiled.
- Do not cover broiler grid with foil since this prevents fat drippings from draining into the bottom of the pan.
- Before broiling, remove excess fat from meat and score edges of fat (do not cut into meat) to prevent meat from curling. Salt after cooking.
- To prevent dry surface on fish or lean meats, brush melted butter on top.
- Foods that require turning should be turned only once during broiling. Turn meat with tongs to avoid piercing and loss of juices.

Broiling Chart

Chart time is based on a preheated broil element using the "HI" setting.

Foods	Rack Position*	Approximate (Minutes/Side)	
		1st Side	2nd Side
BEEF			
Steak (1")	4o		
Medium		9	7
Well		11	8
Hamburgers (¾")	4o		
Medium		5	3-4
Well		6	4-5
PORK			
Bacon	4o	2	1-2
Chops (½")	4o	7	5-6
Chops (1")	3	10-11	9-10
Ham Slice	4o	4	2-3
POULTRY			
Breast Halves (Bone-in)	3	11-12	9-11
SEAFOOD			
Fish Steaks, Buttered (1")	4o	8-10	(no turning)
MISCELLANEOUS			
Hot Dogs	4o	2	2
Toast	4o	1	1

*An "o" after a rack number implies that the offset rack should be used.

Note: This chart is a suggested guide. The times may vary with food being cooked.

Oven Cleaning

How the Self Cleaning Process Works

When the oven controls are set to CLEAN, the oven heats to temperatures that are higher than those used for cooking. The high temperatures cause food soil to burn off and substantially disappear. While this occurs, a device in the oven vent helps to consume normal amounts of smoke. The oven is vented through an opening under the air grille.

How to Prepare Oven Before Operating the Self-Cleaning Process

- Remove the broiler pan and any other utensils from the oven. These utensils cannot withstand the high temperatures of the cleaning process.
- Clean spatters and spills from those areas which will not be cleaned during the self-cleaning process:
 - center front of oven and door near opening in door gasket.
 - porcelain oven door liner (area outside the door gasket).
 - oven front frame.

Note: DO NOT CLEAN serial plate located on the oven front.

To clean these areas, use hot water and detergent, nonabrasive cleansers or soap filled steel wool pads. Rinse thoroughly, being careful not to use an excessive amount of water that would dampen the door gasket. *Soil left in these areas will be more difficult to remove after the self-cleaning process since the high heat will*

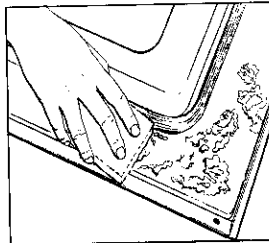

bake on any soil that is present. DO NOT USE COMMERCIAL OVEN CLEANERS TO CLEAN THESE AREAS.

- DO NOT ATTEMPT TO CLEAN, RUB, OR APPLY WATER TO GASKET ON OVEN DOOR. The gasket is essential for a good door seal. Rubbing or cleaning will damage the gasket and may affect the seal.
- Wipe up excess grease and food spillovers which have not baked on the bottom of the oven. Large accumulations of soil can cause heavy smoke or fire in the oven during the cleaning process. For ease of cleaning, the heating element can be lifted slightly.
- Although smoke or fire in the oven is a normal occurrence and there is no safety problem, there will be venting of excessive smoke and odor. Smoke and odor can be removed from the kitchen by turning on the ventilation system.
- Remove the air grille before self-cleaning. Since the oven vent is located just beneath the air grille, soot from the vent could discolor white colored air grilles.

- The oven racks can be cleaned in the oven. However, the oven racks will discolor, lose shininess, and become difficult to slide in and out if left in the oven during the cleaning process. **REMOVE RACKS FROM OVEN IF THIS DISCOLORATION WILL BE OBJECTIONABLE.** As a suggestion, do not leave the racks in the oven during each self-cleaning process if they do not need to be cleaned since they will discolor to a dull silver after the first cleaning. Moderately soiled racks can be cleaned with a soapy S.O.S. pad or Scotch-Brite scour pad. Stubborn stains need to be removed in the self-cleaning process. Be sure to read special tips on page 44 if oven racks are cleaned during the self-cleaning process.

Steps to Follow for Self-Cleaning Process

BASIC INSTRUCTIONS

1. Close door.
2. Touch **Clean Pad**.
3. Touch the appropriate number pad(s) to enter desired cleaning time.
(Light soil-2 hours; Average soil-3 hours; Heavy soil-4 hours)
4. Touch **Stop Time Pad**.*
5. Touch the appropriate number pads to enter desired stop time.*

*Omit steps 4 & 5 if you wish cleaning to begin immediately.

To set oven to start cleaning immediately

1. Close the oven door.
2. Touch **Clean Pad**.
Indicator Words **CLEAN TIME** will flash and Display will show “__ HR : __ __”.
3. Touch the appropriate number pad(s).
The first number pad touched will enter “3:00” in the Display for an average soiled oven. The cleaning time can be varied depending on the amount of soil. Set “2:00” for light soil or “4:00” for heavy soil.
Note: If more than five seconds elapse between touching the **Clean Pad** and touching a number pad, the oven is not set and time of day will automatically return to the Display.

Example: If at 9 o'clock you selected to self-clean your oven for 3 hours, the Display will show:



Five seconds after entering “3:00” or a different time, the oven door will start to automatically latch and the cooling fan will come on. The **LOCK** Indicator Word will come on when the door is latched.

Note: If oven door was left open, the word “door” will flash in the Display and a signal will continuously beep until the door is closed and the **Clean Pad** is touched.

The Indicator Word **ON** comes on when the door is latched and will remain until the clean temperature is reached. The Indicator Word **ON** will cycle with the elements to maintain the clean temperature.

When the clean function has been completed, the Indicator Words CLEAN and ON will go off. The Indicator Word LOCK and the cooling fan will remain on until the oven has cooled down and the door has unlocked.

To set oven to start cleaning at a later time

1-3. Follow Steps 1-3 in previous section on page 41.

4. Touch **Stop Time Pad**.

Indicator Words STOP TIME will flash in the Display. The Indicator Word CLEAN and the calculated stop time will also appear in Display.

5. Touch the appropriate number pads to enter stop time.

A stop time can only be accepted for later in the day. If an unacceptable stop time is entered, "Err" will flash briefly in the Display and then Display will return to previous acceptable Stop Time.

Example: If at 9 o'clock you set the oven to clean for three hours, the calculated stop time would be "12:00". The Display would show:

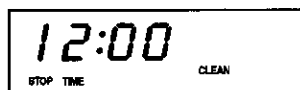

If you want the stop time to be 1 o'clock, touch the number pads "1,0,0". Five seconds later, the Display would show start time:



After five seconds, the Display will return to current time of day, thus showing:



The LOCK Indicator Word will come on and the cooling fan will go off as soon as the oven door has latched.

When the oven begins to clean, the Indicator Word ON and the cooling fan will come on and the Indicator Word DELAY will go off.

When the clean time has been completed, the Indicator Words CLEAN and ON will go off. The Indicator Word LOCK and the cooling fan will remain on until the oven has cooled down and the door has unlocked.

To cancel self-clean

- Touch **Cancel Off Pad**.
- The oven door will be locked while the LOCK Indicator Word remains in the Display. Depending on the length of time the oven had been self-cleaning, it may take up to 45 minutes for the oven to cool down, the door to unlock and cooling fan to turn off.

IMPORTANT

- **To recall cleaning time or stop time:** Touch the appropriate pad (**Clean Pad** or **Stop Time Pad**).
- **To change cleaning time or stop time before cleaning begins:** Repeat the preceding steps.
- When the **Clean Pad** is touched, a fan comes on. If this fan is not operating, the oven will go through the cleaning process at a reduced oven temperature and the oven will not clean effectively. If the fan does not operate, contact your authorized Jenn-Air Service Contractor for service.

More Information on the Self-Cleaning Process

- A slight odor may be detected, and if an oven is heavily soiled, some smoke may be visible. Some smoke and odor during the cleaning process is a normal occurrence. Since the oven vent is located under the air grille, vapors, moisture, etc. may be seen coming from this area. If the odor is strong or objectionable, turn on the ventilation system to exhaust odors to the outdoors. (See p. 10.)
- During the cleaning process, do not be alarmed if an occasional flame is visible through the oven window. This is caused by excessive food soil that was not removed before the oven was set to clean.
- **SINCE THE DOOR AND WINDOW OF THE OVEN WILL GET WARM DURING THE SELF-CLEANING PROCESS, AVOID CONTACT.**
- Some types of soil may disintegrate but leave a light film or heavier deposit of ash. The amount of ash depends on the amount of soil which was in the oven. After oven has cooled, this ash may be removed with a damp sponge. If other dark deposits remain after wiping with a sponge, the time set for the length of cleaning was not enough. Increase the cleaning time for future cleanings or clean more frequently. The normal cleaning time is 3 hours. A maximum of 4 hours may be selected if necessary.

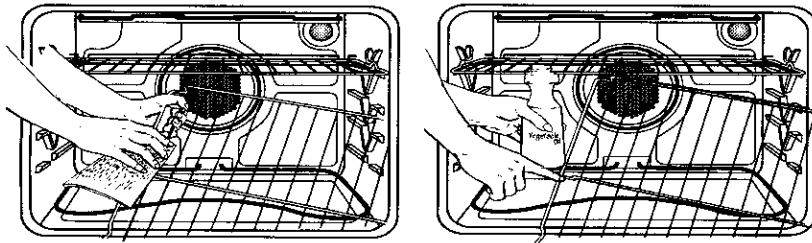

- If racks have been left in oven during the cleaning process, they should be treated as follows. After the cleaning process is completed and the oven has cooled, buff the underside of rack edges with Scotch-Brite scour pad or rub *lightly* the underside of rack edges with a coating of vegetable oil. Use a light application of oil so it does not soil the oven. This will make the cleaned racks slide more easily.
- To remove occasional spillovers between cleanings, use a soap-filled scouring pad or mild cleanser; rinse well.
- It is better to clean the oven regularly rather than wait until there is a heavy buildup of soil in the oven.
- During the cleaning process, the kitchen should be well ventilated to help eliminate normal odors associated with cleaning.
- **DO NOT USE COMMERCIAL OVEN CLEANERS.**
- **DO NOT USE ALUMINUM FOIL OR OTHER LINERS IN THE OVEN.**

Caring For Your Range

Cleaning Other Parts of Your Range

Stainless Steel Rangetop

On the white ranges, the top of the range (the trim around the porcelain burner basin areas), is made of stainless steel.

- To clean light soil, wipe with soapy cloth or nonabrasive cleanser, such as Soft Scrub. Rinse, buff with soft cloth; polish with glass cleaner if necessary.
- To clean moderate soil or discoloration of the surface (excessive heat will cause a golden discoloration), clean with Zud, Bar Keepers Friend, or Luneta (Jenn-Air Model A912, Part No. 712191). With a sponge or cloth, rub cleanser with the grain to avoid streaking the surface. Rinse well, buff dry; polish with a glass cleaner if necessary to remove cleanser residue and smudge marks.
- Heavy soil, such as burned on food soil, can be removed by first cleaning as per the instructions for moderate soil. Stubborn stains can be removed with a damp Scotch-Brite scour pad; rub evenly with the grain to avoid streaking the surface. Rinse well, buff with dry cloth; polish with glass cleaner if necessary to remove cleanser residue and smudge marks. Scotch-Brite is also useful in buffing and removing minor scratches.
- Stubborn food stains may also be removed by spraying with an oven cleaner. Allow to set overnight, then rinse. If stains remain, clean with recommended cleansers such as Zud, Luneta (Jenn-Air Model A912, Part No. 712191), or Scotch-Brite Scour pad.

CAUTION

When using an oven cleaner, avoid spraying areas other than the stainless steel such as the air grille, control knob area or areas around the cooktop. *Immediately wipe up any spray from these areas with a damp cloth.* Read the manufacturer's precautions on using oven cleaners. The caustic materials in these products will discolor materials such as aluminum, brushed or chrome plate. Hint: Oven cleaner can be used to clean the porcelain burner basin.

Textured Black Rangetops

On the black ranges, the top of the range (the trim around the porcelain burner basin areas), is made of painted steel.

- To clean light soil, wipe with a soapy cloth or nonabrasive cleanser, such as Fantastik or 409.
- To clean moderate to heavy soil, spray the area with a household cleaner, such as Fantastik or 409 and allow to soak. If necessary, spray the area with cleanser, cover with plastic wrap and allow to soak for a few hours. Do not use any abrasive cleansers, oven cleaners, or scrub with any abrasive materials, such as S.O.S. pads, Scotch-Brite pads, etc.

Control Knobs

The knobs on the control panel can be removed with the controls in the **Off** position. Pull each knob straight from the shaft. Wash knobs in warm soapy water or dishwasher; do not use abrasive cleansers or materials. To replace each knob, match flat part of knob opening with the flat of the shaft, *returning in Off position*. **Important:** Never use a metal blade to pry knob off.

Control Panel Area and Display Window

Wipe with paper towels dampened with soapy water or glass cleaner. Do not spray any cleaning solutions directly onto the Display window or use large amounts of soap and water. *Do not scrub with S.O.S pads or abrasive cleansers.*

Glass on Oven Door Front

Use any suitable glass cleaner or soapy water.

Oven Door Trim

Slightly dampen a cloth or paper towel with soapy water or nonabrasive cleanser such as Fantastik or 409. Do not use excessive amounts of water or allow water to run down through the air vents under the door handle since this will cause streaks which will be visible through the glass door. White parts may be cleaned with chlorine bleach or a nonabrasive cleanser that contains chlorine bleach. Do not use any abrasive cleansers, oven cleaners, or scrub with any abrasive materials, such as S.O.S. pads, Scotch-Brite pads, etc.

Igniters

- It is important to keep igniter port openings on burners clear and free of obstructions to avoid ignition failure and possible gas buildup. If the port openings are blocked, use a toothpick to remove food particles.
- The igniter cap and stem can be cleaned with warm soapy water and a plastic scrubber. The wire electrode inside the cap can be cleaned with a small brush. Rinse and dry.

Surface Burner Assembly

The surface burner assembly can be cleaned with mild detergents and a plastic scrubber, or washed in the dishwasher. To prevent scratching the burner heads, do not use abrasive cleansers or scrubbing pads. Do **NOT** clean in a self-clean oven.

Note: Check to be sure all ports are open. To open clogged ports, insert a toothpick directly into each port.

Although the burner grate is durable, it will gradually lose its shine and/or discolor, regardless of the care you take of it. This is due to its exposure to the high temperature of the gas flames.

To preserve the porcelain enamel finish as long as possible, have a pan on the grate before you turn on the burner, and lower the flame when food reaches the desired cooking temperature.

Child Protection Lock

The oven operation controls can be locked in the "OFF" position during cleaning or to prevent a child from accidentally turning them on. The oven functions which can be locked in the "OFF" position are: Bake, Convection Bake, Convection Roast, Broil and Clean. The control functions which can always be used regardless of lockout are: Timer, Clock, Fan and Oven Light.

To set

Touch and hold the **Cook Time Pad** and the **Stop Time Pad** simultaneously for four seconds. The Indicator Word "OFF" will appear and remain in the temperature digits for fifteen seconds.

Note: If an oven function is currently being used, the controls cannot be locked off.

Note: If someone touches an oven function pad, the Indicator Word "OFF" will again appear in the temperature digits for fifteen seconds.

To cancel

Touch and hold the **Cook Time Pad** and the **Stop Time Pad** simultaneously for four seconds. The Indicator Word "OFF" will appear briefly in the temperature digits and then go off.

Oven Light Bulb

Before replacing bulb, *disconnect power to oven at the main fuse or circuit breaker panel and at the electric receptacle.* Be sure that the entire oven cavity including the light bulb is cool before attempting to remove.

To replace light bulb

1. Carefully unscrew the glass light lens.
2. To obtain firm grasp on the bulb, wear protective rubber gloves. Remove by turning bulb to the left. *Do not touch a hot oven light bulb with a damp cloth as bulb will break.* **Note:** If the bulb does break and you wish to remove it, be certain power supply is disconnected and wear protective gloves. You may contact your authorized Jenn-Air Service Contractor for service.
3. Replace bulb with a *40 watt oven-rated appliance bulb.* A bulb with a brass base is recommended to prevent fusing of bulb into socket.
4. Replace bulb cover and reconnect power to oven. Reset clock.

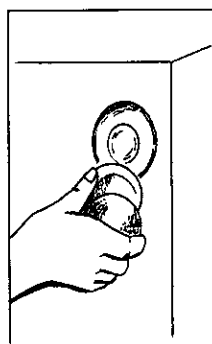

Access Panel

The access panel is easily opened or removed. To open panel, grasp upper corners and pull forward and down. To close panel, lift up and insert prongs into catches in the range.

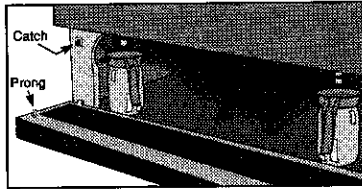

To avoid the possibility of accidentally disconnecting any part of the ventilation system, do not use the area behind the access panel for storage.

Oven Racks

To remove, pull forward to the "stop" position; lift up on the front of the rack and pull out.

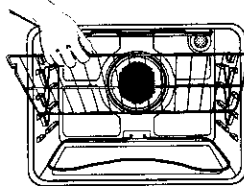

Adjust Oven Temperature

The oven temperature can be adjusted if all oven temperatures are too low or too high and the length of time to cook ALL foods is too long or too short. Do NOT adjust the temperature if only one or two items are not baking properly.

To adjust

1. Touch the **Bake Pad**.
2. Enter 500° by touching the number pads: "5,0,0."
3. Touch and hold the **Bake Pad** for eight seconds until "00°" appears in the Display.
4. Touch the appropriate number pads to enter the offset temperature. (Allowable range is -35° to +35°.) **Note:** Touching the **Broil Pad** will change the - sign to a positive number or back to a negative number.
Note: Do not change the temperature setting more than 10° before checking the oven.
5. Touch the **Cancel Off Pad** to return to the previous Display.

Important: The oven should be adjusted only 10° and the oven should be tested. (We recommend baking two 9" yellow layer cakes using a purchased box mix.) If the oven temperature is still too low or too high, repeat the procedure described above.

How To Remove Range For Cleaning or Servicing

When necessary, follow these procedures to remove appliance for cleaning or servicing:

1. Shut-off gas supply to appliance.
2. Disconnect electrical supply to appliance.
3. Disconnect blower system.
4. Disconnect gas supply tubing to appliance.
5. Remove screws that secure appliance to cabinet or floor. Remove appliance from cabinet.
6. Reverse procedures to reinstall.
7. Test all joints for gas leaks with soap and water solution. **NEVER USE A MATCH OR OTHER FLAME TO LOCATE A GAS LEAK.**

Accessories

Griddle - Model AG302

Self-draining griddle makes many favorite foods easier to fix. Family-sized surface lets you cook several pancakes, hamburgers, or grilled sandwiches at the same time.

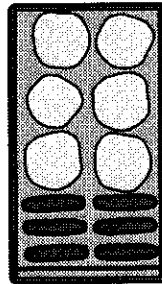

Wok - Model AO142

Ideal for stir-frying, steaming, braising, and stewing. Wok has nonstick finish, wood handles, cover, steaming rack, rice paddles and cooking tips.

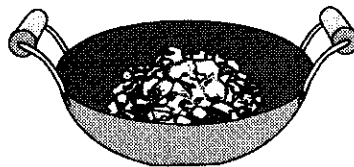

Surface Burner Module - Model AG202

Includes surface burner assembly, aeration tray, and two surface burner grates.

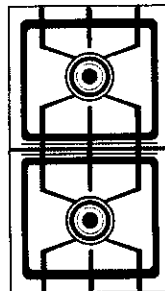

Grill Cover - Model AG341

Attractive grill cover protects grill when not in use. Textured steel with molded handles.

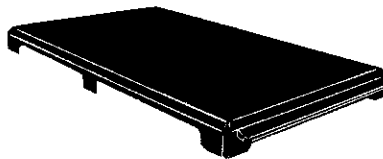

NOTE: Only these accessories are approved for use with your gas grill-range. DO NOT USE Jenn-Air electric grill-range accessories on your gas grill-range.

Before You Call For Service

Check the following list to be sure a service call is really necessary. A quick reference of this manual may prevent an unneeded service call.

If grill or surface burner fails to light:

- check to be sure unit is properly connected to power supply.
- check for a blown circuit fuse or a tripped main circuit breaker.
- check to be sure burner ports or ignition ports are not clogged.
- check to be sure igniter is clicking. If igniter doesn't click, turn control knob **Off** and clean ignitor. (See p. 46.)
- check to be sure appliance regulator is set for correct fuel. (See installation instructions.)
- check to be sure inlet pressure is adequate. (Call gas company.)

If the flame is uneven:

- burner ports may be clogged.
- flame setting may need to be adjusted. (See p. 13.)

If grill or surface burner flame lifts off the ports:

- shutter on the mixer tube needs to be closed until flame settles on the burner ports. (See pp. 12-13.)

If grill or surface burner flame is yellow in color:

- shutter on the mixer tube needs to be opened until yellow disappears. (See pp. 12-13)

If nothing on the range operates:

- check for a blown circuit fuse or a tripped main circuit breaker.
- check if range is properly connected to electric circuit in house.

If ventilation fan does not operate but everything else on the range does:

- check behind lower access panel if power cord to blower assembly has been disconnected.

If ventilation system is not capturing smoke efficiently:

- check on cross ventilation in room or make up air.
- excessive amount of smoke is being created; check instructions for grilling, trimming meats. (See pp. 18-20.)
- outside wall cap may be trapped shut.
- range may be improperly installed; check ducting information. (See p. 9.)
- air filter may be improperly installed (See p. 10.)

If oven does not heat:

- the oven controls may be set incorrectly.
- clock controls may be set for delayed start of oven.

If the oven light does not work:

- the light bulb is loose or defective.
- oven light does not work during self-cleaning process.

If oven will not go through self-cleaning process:

- controls may be improperly set.
- check the clock controlled settings and the current time of day on the clock.

If oven did not clean properly:

- oven may need longer cleaning time.
- excessive spills were not removed prior to self-cleaning process.

If oven door will not unlock:

- oven may not have cooled to safe temperature after self-cleaning process.
- electric current coming into the oven may be off.

If foods do not broil properly:

- the oven controls may not be set properly.
- check rack position.
- voltage into house may be low.

If baked food is burned or too brown on top:

- food may be positioned incorrectly in oven.
- oven not preheated properly.

If foods bake unevenly:

- the range may be installed improperly.
- check the oven rack with a level.
- stagger pans, do not allow pans to touch each other or oven wall.
- check instructions for suggested placement of pans on oven rack.

If oven baking results are less than expected:

- the pans being used may not be of the size or material recommended for best results.
- there may not be sufficient room around sides of the pans for proper air circulation in the oven.
- check instructions for preheating, rack position and oven temperature.
- oven vent may have been blocked or covered.

If baking results differ from previous oven:

- oven thermostat calibration may differ between old and new ovens. Follow recipe and use and care directions before calling for service since the calibration on the previous oven may have drifted to a too high or too low setting. (See p. 48 - Adjusting Oven Temperature.)

If F plus a number appears in the Display:

- a fault code is being shown. When a fault code appears and a continuous beep sounds, touch the **Cancel Off Pad**. If the fault code reappears, disconnect power to the range and call an authorized Jenn-Air Service Contractor.

If You Need Service:

- call the dealer from whom your appliance was purchased or the authorized Jenn-Air Service Contractor listed in the Yellow Pages. Your Jenn-Air Service Contractor can provide better and faster service if you can accurately describe problems and give model and serial number of the appliance. Be sure to retain proof of purchase to verify warranty status. Refer to WARRANTY for further information of owner's responsibilities for warranty service.
- if the dealer or service company cannot resolve the problem, write to Jenn-Air Customer Assistance, c/o Maytag Customer Service, P. O. Box 2370, Cleveland, TN 37320-2370, 1-800-688-1100.
- use and care manuals, service manuals and parts catalogs are available from Jenn-Air Customer Assistance, c/o Maytag Customer Service.

All specifications subject to change by manufacturer without notice.

3035 SHADELAND • INDIANAPOLIS, IN 46226-0901

Free Manuals Download Website

<http://myh66.com>

<http://usermanuals.us>

<http://www.somanuals.com>

<http://www.4manuals.cc>

<http://www.manual-lib.com>

<http://www.404manual.com>

<http://www.luxmanual.com>

<http://aubethermostatmanual.com>

Golf course search by state

<http://golfingnear.com>

Email search by domain

<http://emailbydomain.com>

Auto manuals search

<http://auto.somanuals.com>

TV manuals search

<http://tv.somanuals.com>