

VV[®]JENN-AIR

Use and Care Manual

Gas Range

Models FCG20100, FCG20500 & FCG20510

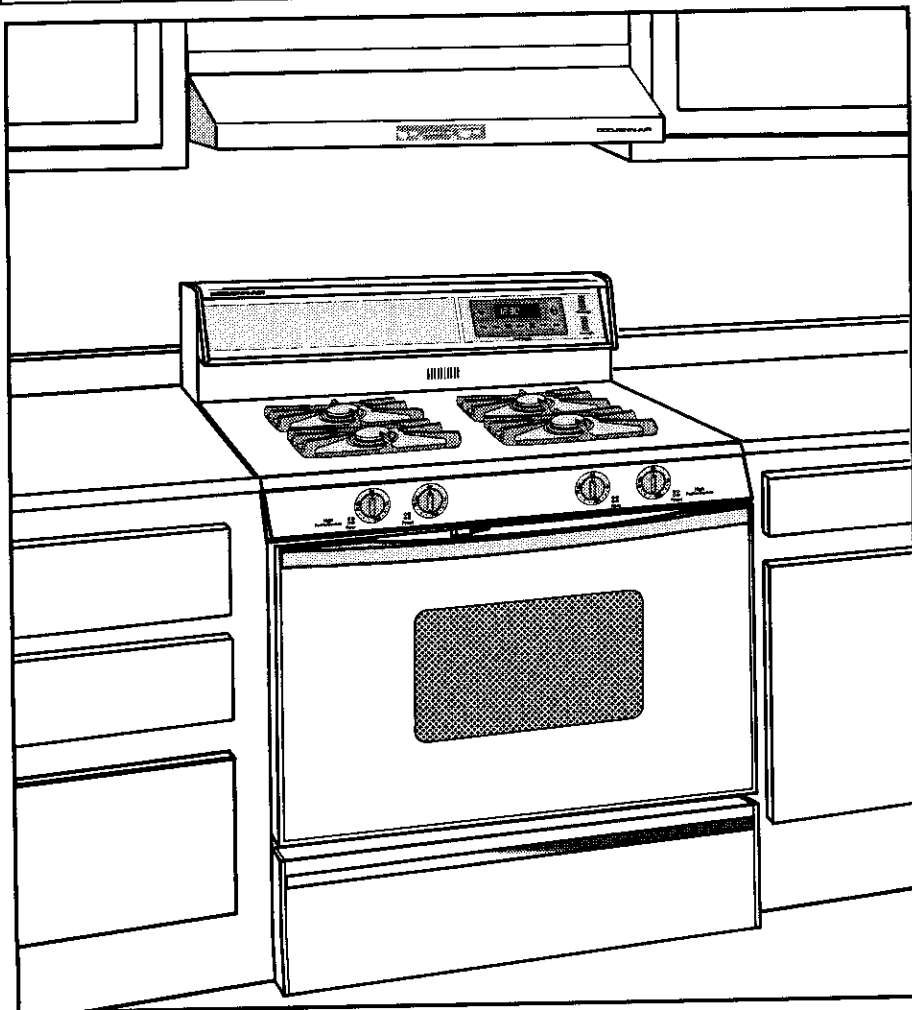

Model FCG20510

WARNING: If the information in this manual is not followed exactly, a fire or explosion may result causing property damage, personal injury or death.

- Do not store or use gasoline or other flammable vapors and liquids in the vicinity of this or any other appliance.

- **WHAT TO DO IF YOU SMELL GAS**
 - Do not try to light any appliance.
 - Do not touch any electrical switch; do not use any phone in your building.
 - Immediately call your gas supplier from a neighbor's phone. Follow the gas supplier's instructions.
 - If you cannot reach your gas supplier, call the fire department.
 - Extinguish any open flame.

- Installation and service must be performed by a qualified installer, service agency or the gas supplier.

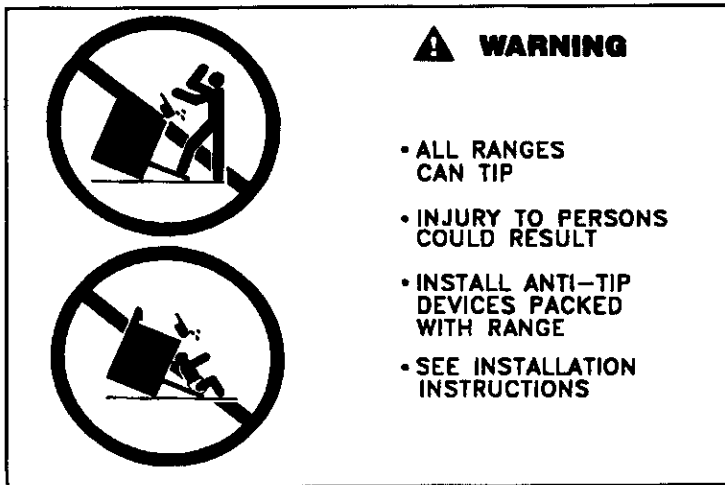

- SAVE THESE INSTRUCTIONS FOR FUTURE REFERENCE -

About Your Jenn-Air Range

Congratulations on your choice of a Jenn-Air gas range. Your range has four sealed gas burners with a self-cleaning electronic controlled oven. As you use your new range, we know you will appreciate the many features that provide excellent performance, ease of cleaning, convenience and dependability.

Before you begin cooking with your new range, please take a few minutes to read and become familiar with the instructions in this book. On the following pages, you will find a wealth of information regarding all aspects of using your new range.

By following the instructions carefully, you will be able to fully enjoy and properly maintain your range and achieve excellent results with the food you prepare.

Should you have any questions about using your Jenn-Air gas range, write to us. Be sure to provide the model number.

Jenn-Air Customer Assistance
c/o Maytag Customer Service
P.O. Box 2370
Cleveland, TN 37320-2370

Index

Appliance Usage

Cooktop & Oven Controls	9
Cleaning Your Range	32-34
Other Hints on Caring for Your Range	35-37
Adjusting Oven Temperature	37
Light Bulb Replacement	36
Safety Precautions	2, 5-8
Service Information	38-39

Cooktop Usage

How A Surface Burner Works	12
Cookware Selection	11
Surface Controls	10

Oven Usage

Baking	
General Recommendations	22
Baking Charts	23
Broiling	26-27
Cleaning	
Self-Cleaning	28-31
Oven Controls & Operations	13-14 & 17-18
Clock Controls	15-16 & 20-21
Rack Positions	19
Roasting	
General Recommendations	24
Roasting Chart	25

SAFETY PRECAUTIONS

Read before operating your range

All appliances - regardless of the manufacturer - have the potential through improper or careless use to create safety problems. Therefore the following safety precautions should be observed:

1. Be sure your appliance is properly installed and grounded by a qualified technician.
2. Never use your appliance for warming or heating the room. This warning is based on safety considerations.
3. Children should not be left alone or unattended in area where appliance is in use. They should never be allowed to sit or stand on any part of the appliance.
4. Wear proper apparel. **Loose-fitting or hanging garments** should never be worn while using the appliance.
5. Do not repair or replace any part of the appliance unless specifically recommended in this manual. All other servicing should be referred to an authorized Jenn-Air Service Contractor.
6. Do not store combustible materials, gasoline or other flammable vapors and liquid near range. This also applies to aerosol sprays and aerosol spray cans.
7. Do not use water on grease fires. Smother fire or flame or use dry chemical or foam-type extinguisher.
8. Use only dry potholders. Moist or damp potholders on hot surfaces may result in burns from steam. Do not use a towel or other bulky cloth.
9. Select cookware large enough to properly contain food and avoid boilovers or spillovers. This will save on cleaning and prevent hazardous accumulations of food, since heavy splattering or spillovers left on a range **can** ignite. Pan size is especially important in deep fat frying.
10. Never leave range unattended at **Hi** heat settings. Boil over causes smoking and greasy spillovers that may ignite.
11. **TYPE OF COOKWARE** - Avoid pans that are unstable and easily tipped. In choosing pans, look for easily-grasped handles that will stay cool. Pans that are too heavy when filled with food can also be a hazard. If pan handles twist and cannot be tightened, discard the pan.

12. HANDLES - Always turn pan handles to the side or back of the range - not out into the room where they are easily hit. COOKWARE HANDLES SHOULD BE TURNED INWARD AND NOT EXTEND OVER ADJACENT SURFACE BURNERS to minimize burns, ignition of flammable materials, and spillage due to unintentional contact with the cookware.
13. CAUTION - Do not store items of interest to children in cabinets above range-children climbing on the range to reach items could be seriously injured.
14. Do not touch surface burner areas or perimeter area around cooktop or interior surfaces of ovens. During and after use, these areas may be hot enough to cause burns. Avoid contact with these areas by clothing or other flammable materials until they have had sufficient time to cool. Other surfaces may become hot enough to cause burns-among these surfaces are the upper door frame and door, oven vent opening and surfaces near the opening, and the top edge of the control panel.
15. Do not heat unopened food containers. Build-up of pressure may cause container to burst and result in injury.
16. Keep all controls "OFF" when unit is not in use.
17. GREASE - Grease is flammable and should be handled carefully. Never leave any cooking operation unattended. Let fat cool before attempting to handle it. Do not allow grease to collect around the range or in the vents. Wipe up spillovers immediately.
18. If the range is installed near a window, proper precautions should be taken to prevent curtains from blowing over burners creating a FIRE HAZARD.
19. Do not use aluminum foil to line burner spillover bowl. Restriction of normal air flow may result in unsafe operation.
20. Clean only parts listed in this manual and use procedures recommended.
21. Always allow hot pans to cool in a safe place out of the reach of small children.
22. A faint gas odor may indicate a gas leak. If a gas odor is detected, shut off the gas supply to the range. Call your installer or local gas company to have the possible leak checked. **Never use a match or other flame to locate a gas leak.**
23. Use care when opening oven door. Let hot air or steam escape before removing or replacing food.

24. Keep oven vent ducts unobstructed. Your range is vented through the base of the backsplash. Never block oven vent or air intakes. Do not obstruct the flow of combustion and ventilation air. Restriction of air flow to the burner prevents proper performance.
25. Always place oven racks in desired location while oven is cool. If rack must be moved while oven is hot, do not let potholder contact oven burner flame.
26. Do not clean door gasket. The door gasket is essential for a good seal. Care should be taken not to rub, damage, or move the gasket.
27. Do not use oven cleaners. No commercial oven cleaner or oven liner protective coating of any kind should be used in or around any part of the oven.
28. **CAUTION: BEFORE SELF-CLEANING THE OVEN, REMOVE FOOD, BROILER PAN AND OTHER UTENSILS.**
29. Before servicing your appliance, disconnect power to the range at the main fuse or circuit breaker panel and at the electrical receptacle.
30. Glazed cookware - only certain types of glass, glass-ceramic, ceramic, earthenware, or other glazed cookware are suitable for cooktop surface without breaking due to the sudden change in temperature. Use only such cookware as you know has been approved for this purpose.
31. Misuse of appliance doors, such as stepping, leaning or sitting on the door may result in possible tipping of the appliance, breakage of door, and serious injuries.
32. Avoid placing the range in a main "traffic path" or in an isolated location with no counter space nearby. Visualize the oven in use before selecting a location. Remember that open oven doors may block a passageway and create a hazard.
33. Always remove soiled broiler pan from the broiler compartment after cooking **for grease left in the pan may become hot enough to ignite.**
34. Do not use oven for storage space.
35. **PREPARED FOOD WARNING:** Follow food manufacturer's instructions. If a plastic frozen food container and/or its film cover distorts, warps or is otherwise damaged during cooking, immediately discard the food and its container. The food could be contaminated.
36. Be sure all packing materials are removed from the range before operating it to prevent fire or smoke damage should the packing material ignite.

- 37. WARNING:** To reduce the risk of tipping of the appliance, the appliance must be secured by a properly installed anti-tip device. To check if device is installed properly: Use a flashlight and look underneath the range to see that one of the rear leveling legs is engaged in the bracket slot. When removing appliance for cleaning, be sure anti-tip device is engaged when range is replaced. The anti-tip device secures the rear leveling leg to the floor, when properly engaged.
- 38.** Have the installer show you the location of the gas shut off valve and how to shut it off in an emergency.
- 39.** Always place a pan of food on a surface burner before turning it on, and turn it off before removing the pan to prevent exposure to the burner flame.
- 40.** This appliance has been tested for safe performance using conventional cookware. Do not use any devices or accessories that are not specifically recommended in this manual. Do not use eyelid covers for the surface units, stovetop grills, or add-on convection systems. The use of devices or accessories not expressly recommended in this manual can create serious safety hazards, result in performance problems, and reduce the life of the components of the appliance.

IMPORTANT SAFETY NOTICE AND WARNING

The California Safe Drinking Water and Toxic Enforcement Act of 1986 (Proposition 65) requires the Governor of California to publish a list of substances known to the State of California to cause cancer or reproductive harm, and requires businesses to warn customers of potential exposures to such substances. Users of this appliance are hereby warned that when the range is engaged in the self-clean cycle, there may be some low level exposure to some of the listed substances, including Carbon Monoxide. Additionally, users are also hereby warned that the burning of gas can result in low-level exposure to some of the listed substances, including benzene, formaldehyde and soot, due primarily to the incomplete combustion of natural gas or liquid petroleum (LP) fuels. Properly adjusted burners will minimize incomplete combustion. Exposure to these substances can be minimized by properly venting the range to the outdoors.

- SAVE THESE INSTRUCTIONS FOR FUTURE REFERENCE -

- 37. WARNING:** To reduce the risk of tipping of the appliance, the appliance must be secured by a properly installed anti-tip device. To check if device is installed properly: Use a flashlight and look underneath the range to see that one of the rear leveling legs is engaged in the bracket slot. When removing appliance for cleaning, be sure anti-tip device is engaged when range is replaced. The anti-tip device secures the rear leveling leg to the floor, when properly engaged.
- 38.** Have the installer show you the location of the gas shut off valve and how to shut it off in an emergency.
- 39.** Always place a pan of food on a surface burner before turning it on, and turn it off before removing the pan to prevent exposure to the burner flame.
- 40.** This appliance has been tested for safe performance using conventional cookware. Do not use any devices or accessories that are not specifically recommended in this manual. Do not use eyelid covers for the surface units, stovetop grills, or add-on convection systems. The use of devices or accessories not expressly recommended in this manual can create serious safety hazards, result in performance problems, and reduce the life of the components of the appliance.

IMPORTANT SAFETY NOTICE AND WARNING

The California Safe Drinking Water and Toxic Enforcement Act of 1986 (Proposition 65) requires the Governor of California to publish a list of substances known to the State of California to cause cancer or reproductive harm, and requires businesses to warn customers of potential exposures to such substances. Users of this appliance are hereby warned that when the range is engaged in the self-clean cycle, there may be some low level exposure to some of the listed substances, including Carbon Monoxide. Additionally, users are also hereby warned that the burning of gas can result in low-level exposure to some of the listed substances, including benzene, formaldehyde and soot, due primarily to the incomplete combustion of natural gas or liquid petroleum (LP) fuels. Properly adjusted burners will minimize incomplete combustion. Exposure to these substances can be minimized by properly venting the range to the outdoors.

- SAVE THESE INSTRUCTIONS FOR FUTURE REFERENCE -

Cooktop and Oven Controls

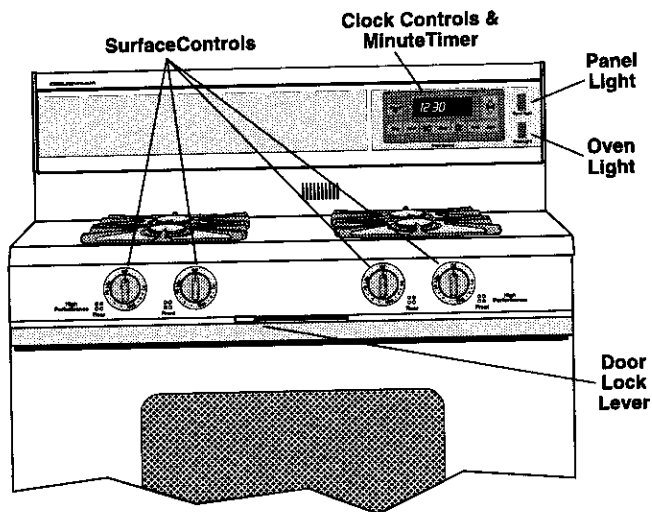

Model FCG20510

Surface Controls

- Use to provide variable heat to range surface burners. (See page 10.)

Oven Controls

- Use to set oven for baking, broiling, and self-cleaning. (See pages 13-14 & 18.)

Clock Controls and Minute Timer

- Features time of day, minute timer and oven clock controls. (See pages 15-16 & 20-21.)

Light Switches

- Use to turn oven and cooktop panel lights on and off. (See page 14.)

Door Lock Lever

- Use to latch the oven door for self-clean. (See page 29.)

Surface Controls

To Set Controls

- Since the controls are a push-turn type, they must be pushed in before turning.
- To set (from the **OFF** position), push in on control knob and immediately turn counterclockwise to the **Lite** setting. After the burner lights, turn the knob to the desired flame size.
- Igniter will continue to spark until knob is turned counterclockwise past **Lite** position.
- **Note:** The burner flame may lift off the burner if a pan is not placed on the grate.
- **Note FCG20100 Owners:** The knob on your range has different graphics than those shown. However, the knob will operate as described below.

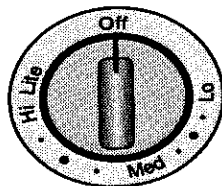

CAUTION: If flame should go out during a cooking operation, turn the burner off. If gas has accumulated and a strong gas odor is detected wait 5 minutes for gas to dissipate before relighting burner.

Control Locations (BTU Rates for Natural)

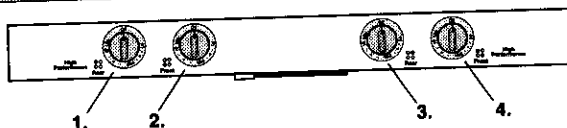

1. Left rear surface burner (12,000 BTUs)
2. Left front surface burner (9,200 BTUs)
3. Right rear surface burner (9,200 BTUs)
4. Right front surface burner (12,000 BTUs)

Note: Use the left rear or right front surface burners on **Hi** for large quantity cooking and canning because the BTU rate is higher.

Suggested Control Settings

The controls offer flexibility in heat setting selection. An infinite number of settings exist between **Hi** and **Lo**. At the **Hi** setting, a detent may be felt. For all settings other than **Hi**, simply adjust your flame for best results.

The size and type of cookware and the amount and type of food being cooked will influence the setting needed for best results. Suggested settings are provided as guidelines.

- Hi:** A fast heat to start cooking quickly, to bring liquids to a boil, to preheat oil for deep fat frying.
(Medium High) For fast frying or browning of foods, to maintain rapid boil of large amounts of food, to maintain oil temperature for deep fat frying.
- Med:** For most frying, sauteing, and slow boil of large amounts of food.
(Medium Lo) For simmering, maintaining boil of small amounts of food.
- Lo:** Maintaining serving temperatures of foods, melting butter or chocolate.



Cookware Selection

To achieve optimum cooking performance, use cookpots with flat bottoms, tight fitting covers, and sized for the surface burner.

Size of Cookware

- *Flame size should be adjusted so it does not extend beyond the edge of the cookware.* This instruction is based on safety considerations. Adjusting the size of the flame to fit the size of the cookware also helps to save fuel.
- Cookpots which extend more than two inches beyond the grate or touch the cooktop may cause heat to build up, resulting in damage to the burner grate, burner or cooktop.
- Speciality items such as woks with a support ring, which restrict air circulation around the burner will cause heat to build up and may result in damage to the burner grate, burner or cooktop. Use Jenn-Air flat bottom wok accessory, Model AO142.

Cookware Materials

- Aluminum cookware heats evenly and quickly. A slightly larger flame size can be used. The flame can be adjusted so it comes to the edge of the cookware. However, the flame should NEVER be adjusted so that it extends beyond the bottom of the cookware.
- Stainless steel cookware with copper or aluminum cores heat evenly and fairly quickly. The flame size should be adjusted to extend only halfway between center and edge of the cookware bottom for best results.
- Cast iron cookware heats slowly.
- Check manufacturer's recommendations before using porcelain on steel, porcelain on cast iron, glass, glass/ceramic, earthenware, or other glazed cookpots.

Covered Cookware

If the cookware is covered, less fuel will be needed; therefore, a lower flame size can be used. **Note:** Food will not cook any faster when more than the amount of heat needed to maintain a gentle boil is used.

Canning

- Acceptable water-bath or pressure canners should not be oversized and should have a flat bottom. The following are not recommended: Oversized canners or a very large canner that rests on two surface burner grates.
- When canning, use the **Hi** setting just until the water comes to a boil or pressure is reached in the pressure canner, then reduce to the lowest flame setting that maintains the boil or pressure.
- Prolonged use of the **Hi** setting or the use of incorrect canning utensils will produce excessive heat. Excessive heat can cause permanent damage to the appliance.

How A Surface Burner Works

When the control knob is turned ON, gas will flow into the burner. The solid state igniter will click until the gas is ignited. (**Note:** All burner igniters will spark regardless of which burner is being operated.)

A properly adjusted burner with clean ports will light within a few seconds. The cone-shaped flame will be clear blue in color with a clearly defined inner cone. There should be no trace of yellow in the flame. If the burner flame is yellow, lifts off the ports, or is noisy, the air/gas mixture may be incorrect. Therefore, contact a service technician to make the needed adjustment.

The infinite surface controls provide flexibility in heat setting selection. (See page 10.)

How to Operate in the Event of a Power Failure

In case of prolonged power failure, you can manually light the surface burner by holding a lighted match near the burner ports and slowly turning the control knob counterclockwise (after depressing) to the **Lite** setting.

Caution: When lighting the surface burner, be sure all of the controls are in the OFF position. Strike the match first and hold it in position before turning the knob to the **Lite** position.

Note: Because your overhead hood fan is electric it will not work during a power failure so smoke and condensation can gather.

Valve Adjustment

The **Lo** setting should produce a stable flame when turning the knob from **Hi** to **Lo**. The flame should extend to the outer edge of the lip on the burner cap when adjusted for the **Lo** setting. Plus, the flame must be stable on all ports on **Lo** setting.

To adjust: Operate burner on **Hi** for about 5 minutes to preheat burner cap. Turn knob back to **Lo**; remove knob, and insert a small screwdriver into the center of the valve stem. Adjust flame size by turning adjustment screw in either direction while holding the valve stem securely.

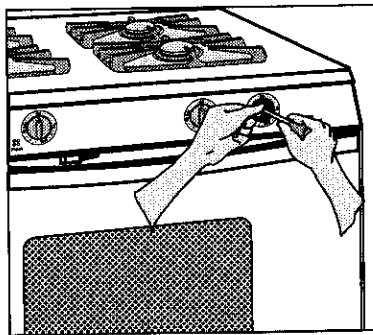

Flame must be of sufficient size to be stable on all burner ports. If flame adjustment is needed, adjust **ONLY** on the **Lo** setting. Never adjust flame size on a higher setting.

Note: All gas adjustments should be done by a qualified servicer only.

Display Window: Shows time of day, timer, and oven functions.

Oven Light Switch (Control Panel): When the door is closed, push the Oven Light Switch to turn oven light on or off. **Models FCG20500 and FCG20510:** The oven light automatically comes on whenever the oven door is opened.

Cooktop Panel/Backsplash Light Switch (Control Panel) (Model FCG20510): Push the Panel Light Switch to turn the backsplash light on or off.

Display Numerals

- Show time of day.
- Countdown of time remaining when using time functions.
- Show temperature of oven as it rises to reach programmed temperature and the set temperature once it is reached.
- Serve as a reminder to latch oven door for self-cleaning operation when the word, *door*, is displayed.
- Recall programmed temperature or time when commanded.

Indicator Words

- Flash to prompt next step.
- Indicate status of programmed function.
- Show programmed function when recalled.

IMPORTANT

DO NOT MOVE DOOR LOCK LEVER TO THE RIGHT DURING A COOKING OPERATION. If the door lock lever is moved to the lock position, the cooking operation will automatically be cancelled and "door" will appear in the display.

Clock Controls

When electrical power is supplied or after power interruption, the last clock time displayed before power was interrupted will flash. Time will advance and continue to flash until clock is reset.

To set time of day:

1. Touch Clock Pad.

Indicator words SET TIME will flash and time digits will appear in the Display. (If more than 30 seconds elapse between touching **Clock Pad** and touching the **Up** or **Down Arrow Pads**, the **Clock Pad** must be touched again in order to set clock.)

2. Touch the Up or Down Arrow Pads in either direction until correct time of day appears in Display.

Note: Three seconds later, time of day will automatically be entered.

To recall time of day when another time function is showing: Touch **Clock Pad**.
(**Note:** To return to another time function pad, touch the appropriate pad.)

To change time of day set on clock: Repeat above sequence.

Note: Clock Time cannot be changed when oven has been programmed for Timed Bake or Self-Clean. Cancel program before reprogramming clock.

Timer

Important: This interval Timer can be used to remind you when a period, up to 9 hours and 50 minutes, expires. It can be used independently of any other oven activity and can be set while another oven function is operating. The Timer does not control the oven.

BASIC INSTRUCTIONS

1. Touch **Timer Pad**.
2. Touch the **Up Arrow Pad**.

To set Timer:

1. Touch **Timer Pad**.
The Indicator Words Set Timer will flash and ":00" appears in the Display.
2. Touch the **Up Arrow Pad** until desired number of hours and minutes appear in Display.

Note: If more than 30 seconds elapse between touching **Timer Pad** and touching the **Up Arrow Pad**, the **Timer Pad** must be touched again to set the numbers.

Important: When entering hours and minutes, hours are to the left of the colon with the Hr Indicator word and minutes are to the right of colon. During the last minute, countdown will be shown in seconds.

Example: Touch the **Up Arrow Pad** until the Display shows: "0HR:05" for 5 minutes or "5 HR:00" for 5 hours and 0 minutes.

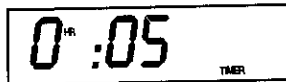

5 minutes



5 hours and 0 minutes

Countdown will automatically start after 3 seconds. At end of time set, the Timer will beep (prolonged beep) 1 time.

To cancel Timer:

1. Hold in **Timer Pad** for 3 seconds.
OR
2. A. Touch **Timer Pad**
B. Touch the **Down Arrow Pad** until ":00" appears in Display Window.

NOTE: Touching **Cancel/Off Pad** will not cancel timer operation but will cancel ALL selected oven programming.

Ignition System

- Your appliance features pilotless ignition. A glow bar will light the oven burner.
- Be sure oven control is set in the OFF position prior to supplying gas to the appliance.
- With this type of ignition system, the oven will not operate during a power failure or if the oven is disconnected from the wall outlet. **No attempt should be made to operate oven during a power failure.**

Oven Burner

The size and appearance of a properly adjusted oven burner flame should be as shown:

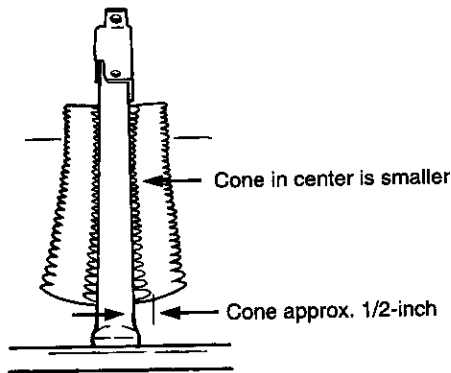

The oven temperature is maintained by cycling the burner on and off. After the oven temperature has been set, there will be about a 45 second delay before the burner ignites. This is normal and no gas escapes during this delay.

During the clean cycle, and some extended oven cooking operations, you may hear a "popping" sound when the burner cycles off. This is a normal operating sound of the burner.

Oven Vent

The oven vent is located at the base of the backsplash. When the oven is in use, this area may feel warm or hot to the touch. To prevent problems do not:

- a. block the vent opening
- b. touch the area near the opening
and
- c. place utensils near the vent opening.

Oven Operation-Baking or Roasting

BASIC INSTRUCTIONS

1. Position oven racks.
2. Touch **Bake Pad**.
3. Touch the **Up or Down Arrow Pads** for desired temperature.

To set oven on bake:

1. Place oven racks on proper rack positions. (See p.19)
2. Touch **Bake Pad**.
Indicator Word **BAKE** and "000°" will appear in the Display.
Note: If more than 30 seconds elapse between touching **Bake Pad** and touching the **Up or Down Arrow Pads**, the oven is not set and Display will return to previous Display.
3. Touch the **Up or Down Arrow Pads** until desired oven temperature appears in the Display. (Allowable range is 170° to 550°.) **Note:** The first tap on an **Arrow Pad** will give you 350° in the Display. After 3 seconds the oven will begin to preheat. The Indicator Words **ON** and **BAKE** will appear in the Display. The temperature shown will be 75° or the oven temperature whichever is higher.

Example: If at 10 o'clock you set the oven for 350° for baking, after 3 seconds the Display will show:



During the preheat, the Display will show a rise in 5° increments until programmed temperature is reached. When the oven is preheated, the oven will beep, the **ON** and **BAKE** Indicator Words and programmed oven temperature will remain in the display.

Note: Oven will preheat for approximately 7 to 10 minutes.

To recall temperature set during preheat: Touch the **Bake Pad**. Temperature will be briefly displayed, then will automatically return to on-going program.

To change temperature set: Touch the **Bake Pad** and touch the **Up or Down Arrow Pads** for a new desired temperature.

4. Touch **Cancel/Off Pad** to turn oven off at end of baking.

Rack Positions

The rack positions noted are generally recommended for the best browning results and most efficient cooking times. Refer to baking and roasting sections for recommendations for specific foods.

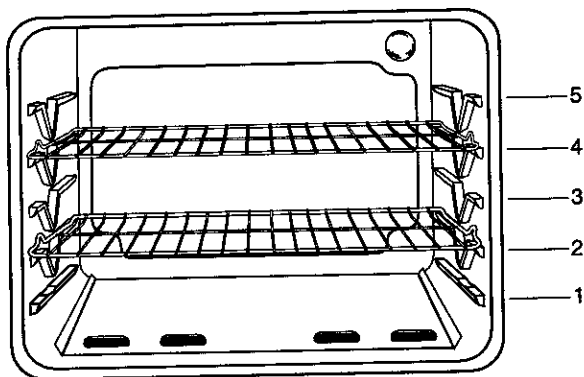

Use Rack Position #1:

Large cuts of meat and large poultry, angel food cake, frozen fruit pie, dessert souffle.

Use Rack Position #2:

Roasting small cuts of meat, cakes (tube, bundt or layer) custard pie, pie shell, large casseroles, loaves of bread.

Use Rack Position #3:

Most baked goods on cookie sheets, frozen convenience foods, fresh fruit pie, cream pie, cakes (sheet and layer), main dish souffle.

Use Rack Position #4:

Most broiling.

Use Rack Position #5:

Toasting bread.

Multiple Rack Cooking:

Two racks, use #2 and #4 or #1 and #4.

Clock Controlled Baking or Roasting

BASIC INSTRUCTIONS

1. Touch **Bake Pad**.
2. Touch the **Up or Down Arrow Pads** for desired temperature.
3. Touch **Cook Time Pad**.
4. Touch the **Up Arrow Pad** to enter cooking hours & minutes.
5. Touch **Stop Time Pad**.*
6. Touch the **Up Arrow Pad** to enter **Stop Time**.*

*Omit steps 5 & 6 if you want baking to start immediately.

To set oven to start immediately and shut off automatically:

1. Touch **Bake Pad**
Indicator Word **BAKE** and "000°" will be shown in Display.
2. Touch the **Up or Down Arrow Pads** until desired oven temperature appears in the Display. After 3 seconds the oven will begin to preheat. The Indicator Words **ON** and **BAKE** will appear in the Display. The temperature shown will be 75° or the temperature of the oven, whichever is higher.

Example: If at 10 o'clock you set the oven for 350° for baking, the Display will show:



During the preheat, the Display will show a rise in 5° increments until programmed temperature is reached. When the oven is preheated, the oven will beep, the **ON** and **BAKE** Indicator Words and programmed oven temperature will remain in the display.

3. Touch **Cook Time Pad**.
Indicator Words **SET COOK TIME** will flash and Display will show "0 HR:00".
 4. Touch the **Up Arrow Pad** to enter cooking hours in 5 minute increments.
Hours are to left of colon and minutes to right of colon.
(Allowable range is 10 minutes to 11 hours and 55 minutes.)
- Example:** If cooking time selected for the oven is 2 hours and 30 minutes, after 3 seconds the Display will show:



and, the oven begins to preheat.

Important: Oven will preheat for approximately 7 to 10 minutes. At end of programmed Cook Time, oven will shut off automatically; retained heat will continue to cook food. Clock controlled cooking is not recommended for baked items that require a preheated oven, such as cakes, cookies, pies, breads. For these foods, place food in preheated oven, then use Timer to signal end of baking time.

At the end of programmed Cook Time, the oven will shut off automatically and intermittent "beeps" will signal until the **Cancel/Off Pad** is touched.

To set oven to start at future time and shut off automatically:

1.-4. Follow preceding Steps 1-4.

5. Touch **Stop Time Pad**.

Indicator Words SET STOP TIME will flash. Display will show the calculated stop time based on current time of day and cook time.

6. Touch the **Up Arrow Pad**. A stop time can only be accepted for later in the day.

Note: Since food continues to cook if left in the oven, it is suggested that the clock controls be used primarily to start the oven when no one is in the kitchen. Provisions should be made to have the food removed as soon as the signal has sounded.

Example: If at 10 o'clock you set the oven for 350° for baking and 2 hours and 30 minutes cooking time, the calculated stop time would be "12:30". The Display will show:



If you want the stop time to be 1 o'clock, touch the **Up Arrow Pad** until "1:00" appears in the Display Window. The Display Window will show:



If you want the Display Window to return to the current time of day, touch **Clock Pad**, the Display Window will show:



At the end of the delayed period, the DELAY Indicator Word will go off and the oven will begin to heat. 75° will be shown. As the oven heats, the Display will show a rise in increments of 5° until programmed temperature is reached. At the end of programmed Cook Time, the oven will shut off automatically and intermittent "beeps" will be heard. Touch **Cancel /Off Pad** to cancel beeps.

To recall time function programmed: Touch the appropriate time pad.

To cancel: Touch **Cancel/Off Pad**.

NOTE: If more than 30 seconds elapse between touching a function pad and touching the **Up Arrow Pad**, the oven is not set and Display will return to previous Display.

Baking

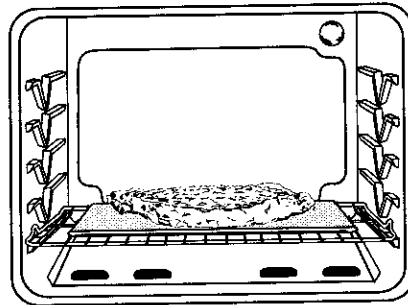
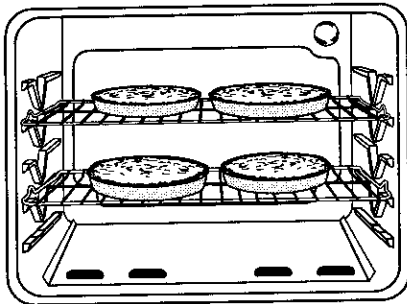

General Baking Recommendations

- When cooking foods for the first time in your new oven, use recipe cooking times and temperatures as a guide.
- Use tested recipes from reliable sources.
- Preheat the oven only when necessary. For baked foods that rise and for richer browning, a preheated oven is better. Casseroles can be started in a cold oven. Preheating takes from 7 to 10 minutes; place food in oven after Preheat beep.
- Arrange oven racks before turning on oven. Follow suggested rack positions on pages 19 and 23.
- Allow about 2 inches of space between the oven side walls and pans to allow proper air circulation.
- When baking foods in more than one pan, place them on opposite corners of the rack. *Stagger pans* when baking on two racks so that one pan does not shield another unless shielding is intended. (See above)
- To conserve energy, avoid frequent or prolonged door openings. At the end of cooking, turn oven off before removing food.
- Always test for doneness (fingertip, toothpick, sides pulling away from pan). Do not rely on time or brownness as the only indicators.
- Use good quality baking pans and the size recommended in the recipe.
- Dull, dark, enameled or glass pans will generally produce a brown, crisp crust. Shiny metal pans produce a light, golden crust.
- Frozen pies in shiny aluminum pans should be baked on a cookie sheet on rack 1 or be removed to a dull or glass pan.

Baking Chart

Product and Type	Pan Size	Rack Position	Bake Temp. (°F) Preheated	Bake Time* (min.)
CAKE				
Yellow - 2 layers	9"	2 or 3	350°	28-33
White - 2 layers	9"	2 or 3	350°	25-30
Chocolate - 2 layers	9"	2 or 3	350°	30-35
Bundt	10" tube	1 or 2	350°	35-45
Angel Food	10" tube	1	375°	30-40
Pound Cake	9x5 loaf	2	325°	55-60
Cupcakes		3	350°	15-25
Sheet Cake	9x13"	2 or 3	350°	30-40
PIES				
Two Crust				
Fruit, fresh	9"	3	400°-425°	45-60
Fruit, frozen	9"	1	385°-400°	60-70
One Crust				
Custard, fresh	9"	2	350°	60-80
Cream/Meringue	9"	3	400°	8-10
Pie Shell	9"	2	425°	8-12
COOKIES				
Chocolate Chip		3	350°-375°	8-12
Peanut Butter		3	350°-375°	8-12
Sugar		3	350°-375°	8-12
Brownies	9x13"	2	350°	25-35
BREADS, YEAST				
Loaf	9x5 loaf	2 or 3	375°	20-30
Rolls		3	375°	15-20
BREADS, QUICK				
Loaf, Nut, Fruit	8x4 loaf	2 or 3	375°	50-60
Gingerbread	9x9"	3	350°	30-35
Cornbread	8x8"	3	400°	15-25
Cornbread Muffins		3	375°-400°	15-22
Biscuits		2 or 3	400°-425°	8-15
Muffins		3	375°-400°	15-22

* The times given are based on specific brands of mixes or recipes tested. Actual times will depend on the ones you bake.

Roasting

General Roasting Recommendations

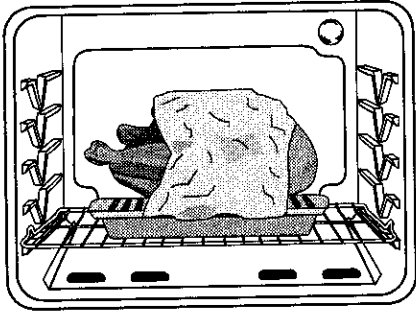

- *Preheating is not necessary.*
- For open pan roasting, place meat or poultry on the slotted portion of the two-piece pan included with the oven. Do not add water to the pan. Use open pan roasting for tender cuts of meat. Less tender cuts of meat need to be cooked by moist heat in a covered pan.
- For best results, a meat thermometer is the most accurate guide to degree of doneness. The tip of the thermometer should be located in the thickest part of a roast, not touching fat, bone, or gristle. For turkeys and large poultry products, insert the tip of the thermometer into the thickest part of the inner thigh.
- Place roast fat side up to allow self basting of meat during roasting.
- Since meats continue to cook after being removed from the oven, remove roast from oven when it reaches an internal temperature about 5 degrees below the temperature desired.
- For less loss of juices and easier carving, allow about 15 minutes standing time after removing meat from oven.
- For best results in roasting poultry, thaw completely. Due to the structure of poultry, partially thawed poultry will cook unevenly.
- Minutes per pound will vary according to the size, shape, quality, and initial temperature of meat as well as the electrical voltage in your area. Times are based on refrigerator cold meat.
- A large cut of meat will usually require fewer minutes per pound to roast than a smaller cut of meat.
- Since the breast meat on a large turkey cooks more quickly than the thigh area, place a foil cap over the breast area after desired brownness is reached to prevent over browning. (See above)
- A stuffed turkey will require an extra 30 to 60 minutes depending on size. Stuffing should reach an internal temperature of 165°F.
- Use meat roasting charts in standard cookbooks for recommended times and temperatures for roasting cuts of meat not found on p.25.

Roasting Chart (Thawed Meats Only)

Variety and Cut of Meat	Approx. Weight (pound)	Oven Temp. (not pre-heated)°F	Internal Temp. of Meat-End of Roasting Time °F	Approx. Roasting Time (minutes per pound)
BEEF				
Rib Roast	4 to 8	325°	140° (rare) 160° (medium)	25-30 30-35
Rib Eye Roast	4 to 6	325°	140° (rare) 160° (medium)	25-30 30-35
Tenderloin Roast	2 to 3	400°	140° (rare)	20-25
Eye of Round Roast	4 to 5	325°	140° (rare) 160° (medium)	25-30 30-35
Top Sirloin Roast	3 to 6	325°	140° (rare) 160° (medium)	25-30 30-35
Round Tip Roast	4 to 6	325°	140° (rare) 160° (medium)	25-30 30-35
PORK				
Shoulder Blade Roast Boneless	4 to 6	325°	170°	35-45
Shoulder Blade Roast	4 to 6	325°	170°	30-40
Top Loin Roast	3 to 4	325°	170°	35-45
Leg (Fresh Ham)	10 to 16	325°	170°	25-35
Ham, Half (Fully cooked)	5 to 7	325°	140°	25-35
Ham, Half (Cook before eating)	5 to 7	275°	160°	35-45
Arm Picnic Shoulder	5 to 8	325°	140°	25-30
POULTRY				
Turkey, unstuffed	8 to 12	325°	180°-185°	20-22
Turkey, unstuffed	12 to 16	325°	180°-185°	18-20
Turkey, unstuffed	16 to 20	325°	180°-185°	16-18
Turkey, unstuffed	20 to 24	325°	180°-185°	14-16
Turkey, Breast	3 to 8	325°	170°-175°	30-40
Chicken, Whole	2½ to 3½	375°	185°	20-24
Cornish Game Hen	1 to 1½	375°	180°-185°	45-55
Duck	4 to 6	350°	185°	20-25

Broil

BASIC INSTRUCTIONS

1. Position oven rack.
2. Touch **Broil Pad**.
3. Touch the **Up or Down Arrow Pads**.

To Broil

1. Place oven rack on the rack position suggested in the chart. Distance from broiling burner depends on foods being prepared. Rack position #4 is usually recommended unless otherwise stated.

2. Touch **Broil Pad**.

Indicator Word BROIL and 000° will appear in the Display.

Note: If more than 30 seconds elapses between touching **Broil Pad** and touching the **Up or Down Arrow Pads**, the oven is not set and the Display will return to previous Display.

3. Touch the **Up Arrow Pad** to select Hi Broil or the **Down Arrow Pad** to select Lo Broil.

Use Hi Broil for most broil operations. When broiling longer cooking foods such as pork chops, poultry or thick steaks, select Lo Broil. Low temperature broiling allows food to cook to the well done stage without excessive browning.

Three seconds later, the broil burner will come on and the Indicator Words BROIL and ON will remain in the Display.

Example: If at 4 o'clock you set the oven for broil (HI), the Display will show:



4. Place food on broiler pan provided with oven. PREHEAT broil burner for 5 minutes.
5. Touch **Cancel/Off Pad** to turn off oven when food is cooked.

Broiling Tips

- Tender cut of meat or marinated meats are best for broiling. This includes rib and loin cuts of steak, ground beef, ham steaks, lamb chops, poultry pieces or fish. For best results, steaks should be at least 1" thick. Thinner steaks should be pan-broiled.
- Do not cover broiler grid with foil since this prevents fat drippings from draining into bottom of pan.
- Before broiling, remove excess fat from meat and score edges of fat (do not cut into meat) to prevent meats from curling. Salt after cooking.
- To prevent dry surface on fish or lean meats, brush melted butter on top.
- Foods that require turning should be turned only once during broiling. Turn meat with tongs to avoid piercing and loss of juices.

Broiling Chart (Preheated)

Foods	Rack Position	Broil Setting	Approximate (Minutes/Side)	
			1st Side	2nd Side
BEEF				
Steak (1")				
Rare	4	Hi	5-6	4-5
Medium	4	Hi	7-8	5-6
Well	4	Lo	10-11	8-9
Hamburgers (3 oz.)				
Medium	4	Hi	5-6	4-5
Well	4	Lo	7-8	5-6
PORK				
Bacon - Thick slice	3	Lo	3-4	1-2
Chops (1/2")	4	Hi	6-7	5-6
Chops (1")	3	Lo	12-13	10-11
Ham Slice	4	Hi	4	3
Sausage Links	4	Hi	4	3
Sausage Patties	4	Hi	3-4	3
POULTRY				
Breast Halves, bone in	3	Lo	10-11	8-9
SEAFOOD				
Fish Fillets, Buttered (1/4")	4	Hi	8-10	No Flip
Fish Steaks (1")	4	Lo	10-12	No Flip
MISCELLANEOUS				
Hot Dogs	4	Hi	2-3	2-3
Toast	5	Hi	1-2	1-2

Note: This chart is a suggested guide. The times may vary with food being cooked.

Oven Cleaning

How the Self-Cleaning Process Works

When the oven controls are set to CLEAN, the oven heats to temperatures that are higher than those used for cooking. The high temperatures cause food soil to burn off and substantially disappear. While this occurs, a device in the oven vent helps to consume normal amounts of smoke. The oven is vented at the base of the backsplash.

How to Prepare Oven Before Operating the Self-Cleaning Process

- Remove the roasting/broiler pan and any other utensils from the oven. These utensils cannot withstand the high temperatures of the cleaning process.
- Clean spatters and spills from those areas which will not be cleaned during the self-cleaning process:
 - center front of oven and door near opening in door gasket.
 - porcelain oven door liner (area outside the door gasket).
 - oven front frame.

To clean these areas, use hot water and detergent, nonabrasive cleansers or soap filled steel wool pads. Rinse thoroughly, being careful not to use an excessive amount of water that would dampen the door gasket. *Soil left in these areas will be more difficult to remove after the self-cleaning process since the high heat will bake on any soil that is present.* **DO NOT USE COMMERCIAL OVEN CLEANERS TO CLEAN THESE AREAS.**

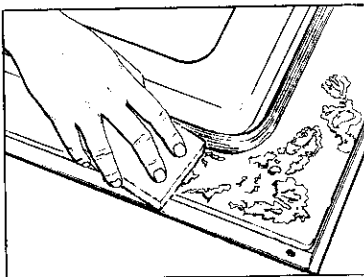

- **DO NOT ATTEMPT TO CLEAN, RUB, OR APPLY WATER TO GASKET ON OVEN DOOR.** The gasket is essential for a good door seal. Rubbing or cleaning will damage the gasket and may affect the seal.
- Wipe up excess grease and food spillovers which have not baked on the bottom of the oven. Large accumulations of soil can cause heavy smoke or fire in the oven during the cleaning process.
- Although smoke or fire in the oven is a normal occurrence and there is no safety problem, there will be venting of excessive smoke and odor.

- The oven racks can be cleaned in the oven. However, the oven racks will discolor, lose shininess, and become difficult to slide in and out if left in the oven during the cleaning process. **REMOVE RACKS FROM OVEN IF THIS DISCOLORATION WILL BE OBJECTIONABLE.** As a suggestion, do not leave the racks in the oven during each self-cleaning process if they do not need to be cleaned since they will discolor after the first cleaning. Moderately soiled racks can be cleaned with a soapy S.O.S. pad or Scotch-Brite scour-pad. Stubborn stains need to be removed in the self-cleaning process. Be sure to read special tips on page 31 if oven racks are cleaned during the self-cleaning process.

Steps to Follow for Self-Cleaning Process

BASIC INSTRUCTIONS

1. Close door.
2. Move door lock lever to locked position.
3. Touch **Clean Pad**.
4. Touch the **Up or Down Arrow Pads** to change cleaning time. (Light soil- 2 hours; Average soil-3hours; Heavy soil-4 hours)

To set oven to start cleaning immediately:

1. Close the oven door.
2. Move door lock lever to locked position.

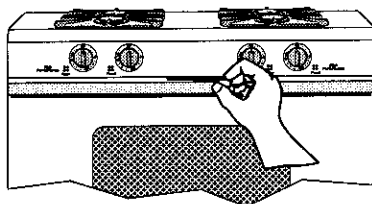

3. Touch **Clean Pad**.

Indicator Words SET CLEAN TIME will flash and Display will show :



After three seconds , the ON Indicator Word will come on and the oven will begin to clean. The LOCK Indicator Word will come on when the oven reaches cleaning temperatures.

Note: If door lever is not in locked position, "door" will flash in the Display.

4. If you wish to change cleaning time after the word ON has appeared in the display, then a) touch **Clean Pad**; b) touch the **Up or Down Arrow Pads**. (Range is from 2 hours for light soil up to 4 hours for heavy soil.)

Example: If you select to self-clean your oven for 4 hours, the Display will show:



When the clean function has been completed, the Indicator Words CLEAN and ON will go off. The Indicator Word LOCK will remain on until the oven has cooled down.

To set oven to start cleaning at a later time:

1. Close door.
2. Move door lock lever to locked position.
3. Touch **Clean Pad**.
4. Touch the **Up** or **Down Arrow Pads** to change desired clean time.
5. Touch **Stop Time Pad**.
Indicator Words SET STOP TIME will flash in the Display. The calculated stop time will also appear in Display.
6. Touch the **Up Arrow Pad** to enter stop time.
A stop time can only be accepted for later in the day.
Example: If at 8 o'clock you set the oven to clean for 4 hours, the calculated stop time would be "12:00". The Display will show:



If you want the stop time to be 1 o'clock, touch the **Up Arrow Pad**. Three seconds later, the Display will show the set stop time. The Indicator Word DELAY will come on and the Display will show:



When the oven begins to clean, the Indicator Word ON will come on and the Indicator Word DELAY will go off.

When the clean time has been completed, the Indicator Words CLEAN and ON will go off. The Indicator Word LOCK will remain on until the oven has cooled down.

To recall cleaning time, current time of day or stop time: Touch the appropriate pad.

To change cleaning time or stop time before cleaning begins: Touch **Cancel/Off Pad** and repeat the preceding steps.

To cancel cleaning process: Touch **Cancel/Off Pad**. The oven door will be locked while the LOCK Indicator Word remains in the Display. Depending on the length of time the oven had been self-cleaning, it may take up to 45 minutes for the oven to cool down. After Lock Indicator Word goes out of the Display, move the Door Lock Lever to the left.

Important: Forcing the door lock lever to the left prior to the LOCK Indicator Word going out will damage the lock mechanism.

More Information on the Self-Cleaning Process

- A slight odor may be detected, and if an oven is heavily soiled, some smoke may be visible. Some smoke and odor during the cleaning process is a normal occurrence. Since the oven vent is at the bottom of the control panel, vapors, moisture, etc. may be seen coming from this area.
- During the cleaning process, do not be alarmed if an occasional flame is visible through the oven window. This is caused by excessive food soil that was not removed before the oven was set to clean.
- **SINCE THE DOOR AND WINDOW OF THE OVEN WILL GET WARM DURING THE SELF-CLEANING PROCESS, AVOID CONTACT.**
- Some types of soil may disintegrate but leave a light film or heavier deposit of ash. The amount of ash depends on the amount of soil which was in the oven. After oven has cooled, this ash may be removed with a damp sponge. If other dark deposits remain after wiping with a sponge, the time set for the length of cleaning was not enough. Increase the cleaning time for future cleanings or clean more frequently. The normal cleaning time is 3 hours. A maximum of 4 hours may be selected if necessary.

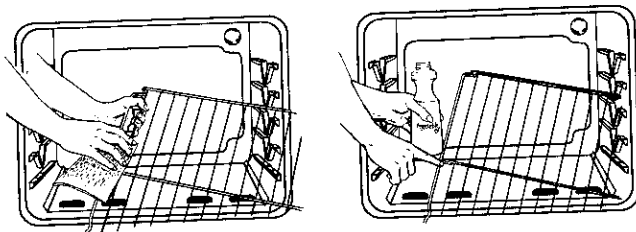

- If racks have been left in oven during the cleaning process, they should be treated as follows. After the cleaning process is completed and the oven has cooled, buff the underside of rack edges with Scotch-Brite scour-pad or rub *lightly* the underside of rack edges with a coating of vegetable oil. Use a light application of oil so it does not soil the oven. This will make the cleaned racks slide more easily.
- To remove occasional spillovers between cleanings, use a soap-filled scouring pad or mild cleanser; rinse well.
- It is better to clean the oven regularly rather than wait until there is a heavy build-up of soil in the oven.
- During the cleaning process, the kitchen should be well ventilated to help eliminate normal odors associated with cleaning.
- **DO NOT USE COMMERCIAL OVEN CLEANERS.**
- **DO NOT USE ALUMINUM FOIL OR OTHER LINERS IN THE OVEN.**

Cleaning Parts of Your Range

Be sure all controls are OFF and all range parts are cool before cleaning.

Cooktop

The cooktop is designed with two contoured wells which contain spills until they can be wiped up. Unlike the standard gas appliance, **THIS COOKTOP DOES NOT LIFT-UP NOR IS IT REMOVABLE.** To prevent damage to the gas tubing or top, do not attempt to lift cooktop.

Never wipe a warm or hot porcelain enamel surface with a damp cloth. For general daily cleaning and light soil, wash with warm soapy water, rinse, and dry. To remove grease spatters, spray with cleaners such as Fantastik or 409. **DO NOT** use abrasive or caustic cleaning agents which may permanently damage the finish.

Surface Burner Grates

The surface burner grates are made of porcelain on cast iron or stamped steel, depending on your model. Therefore, the grates can be washed in the sink with mild detergents and a plastic scrubber or washed in the dishwasher.

Burner grates must be properly positioned before cooking. Do not operate the burners without a pan on the grate. The porcelain finish on the grate may chip without a pan to absorb the intense heat.

When reinstalling square grates, place indented sides together so straight sides are at front and rear.

Although the burner grate is durable, it will gradually lose its shine and/or discolor, regardless of the care you take of it. This is due to its exposure to the high temperature of gas flames.

To preserve the porcelain enamel finish as long as possible, have a pan on the grate before you turn on the burner, and lower the flame when food reaches the desired cooking temperature.

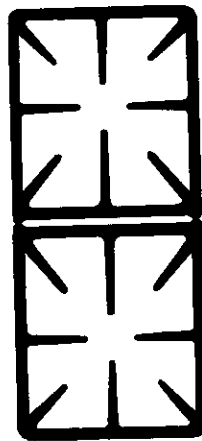

Sealed Burners

The four sealed burners are secured to the cooktop and are NOT designed to be removed. Since the four burners are sealed into the cooktop, boilovers won't seep underneath to the burner box area. Thus, there are no hidden spills in the burner box area to clean.

For ease of cleaning, remove soil from the burner as soon as the burner has cooled. If food boils over, remove pan to another burner. Then, cool soiled burner and clean.

Be sure burner is cool before cleaning to prevent damaging the porcelain surface. Clean with warm soapy water and a sponge or dishcloth. Burned on grease can be removed with a household cleaner, such as Fantastik or 409, and a sponge. To prevent scratching, do not use abrasive cleaners or scrubbing pads.

Note: Be careful not to get water or spray into burner ports.

Igniters

When cleaning around the surface burner, use care to prevent damage to the spark igniter which is located at the back-side of each burner. If a cleaning cloth should catch the igniter, it could damage or break it. If the igniter is damaged or broken, the surface burner will not light. Plus, the burner will not light if the small port beneath the igniter is blocked.

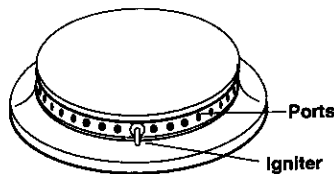

REAR VIEW OF SEALED BURNER

Control Knobs

The knobs on the control panel can be removed with the controls in the OFF position. Pull each knob straight from the shaft. Wash knobs in warm soapy water or dishwasher; do not use abrasive cleansers or materials. To replace each knob, match flat part of knob opening with the flat on the shaft, *returning in OFF position*.

Important: Never use a metal blade to pry knob off. If knob cannot be easily removed, tuck the folds of a cloth dishtowel under the knob skirt and pull the towel upward with steady, even pressure.

Important: Be careful to replace the knobs with gentle pressure. Never hit the knob on the shaft with your hand or any other object.

Control Panel

Wipe with a damp cloth. Dry thoroughly. Do not use cleaning sprays, large amounts of soap and water, abrasives, or sharp objects on the panel. They can damage it. To prevent moisture from getting behind control panel, spray a cloth with glass cleaner. Then, wipe the panel.

Backsplash and Glass on Oven Door Front

Use any suitable glass cleaner or soapy water.

Porcelain Areas

- Wash cool range with warm soapy water and rinse. Polish with a dry cloth.
- Do not use abrasive or caustic cleaning agents which may permanently damage the finish.
- NEVER WIPE OFF A WARM OR HOT PORCELAIN ENAMEL SURFACE WITH A DAMP CLOTH.

NOTE: The porcelain enamel used on your range is acid resistant, not acid proof. Therefore, acid foods (such as vinegar, tomato, milk, etc.) spilled on the range should be wiped up immediately with a dry cloth.

Other Hints on Caring for Your Range

Oven Racks

To remove pull forward to the stop position; lift up on the front of the rack and pull out.

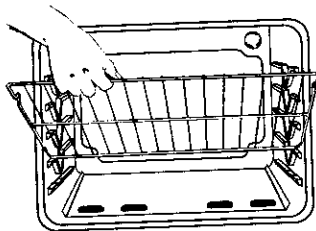

Oven Bottom

Protect oven bottom against excessive spillovers especially acid or sugary spillovers as they may discolor the porcelain. Use the correct size cooking utensil to avoid boilovers. Never place cookware or aluminum foil directly on the oven bottom.

To remove: When cool, remove the oven racks. Slide the two catches, located at each rear corner of the oven bottom, toward the front of the oven. Lift the rear edge of the oven bottom slightly, then slide it back until the front edge of the oven bottom clears the oven front frame. Remove oven bottom from oven.

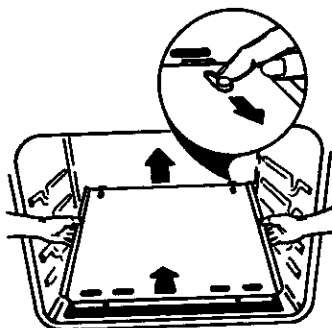

To replace: Fit front edge of oven bottom into front frame. Lower rear of oven bottom and slide the catches back to lock oven bottom into place.

How to Remove Range for Cleaning and Servicing

Follow these procedures to remove appliance for cleaning or servicing.

1. Shut-off gas supply to appliance.
2. Disconnect electrical supply to appliance, if equipped.
3. Disconnect gas supply tubing to appliance.
4. Slide range forward to disengage range from the anti-tip bracket. (See Installation Instructions for location of bracket.)
5. Reverse procedure to reinstall. If gas line has been disconnected, check for gas leaks after reconnection. (See Installation Instructions for gas leak test method.)

Note: A qualified servicer should disconnect and reconnect the gas supply. To prevent range from accidentally tipping, range must be secured to the floor by sliding rear leveling leg into an anti-tip bracket supplied with the range.

WARNING: Possible risks may result from abnormal usage, including excessive loading of the oven door and of the risk of tip over, should the appliance not be reinstalled according to the installation instructions.

Oven Light Bulb

Before replacing bulb, *disconnect power to oven at the main fuse or circuit breaker panel*. Be sure that the entire oven cavity including the light bulb is cool before attempting to remove.

To replace light bulb:

1. Carefully unscrew the glass light lens.
2. To obtain firm grasp on bulb, wear protective rubber gloves. Remove by turning bulb to the left. Do not touch a hot oven light bulb with a damp cloth as bulb will break. **Note:** If the bulb does break and you wish to remove it, be certain power supply is disconnected and wear protective gloves. You may contact your authorized Jenn-Air Service Contractor for service.
3. Replace bulb with a 40 watt oven-rated appliance bulb. Bulb with brass base is recommended to prevent fusing of bulb into socket.
4. Replace bulb cover and reconnect power to oven. Reset clock.

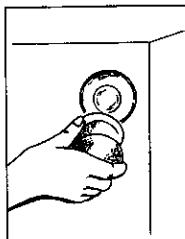

Backsplash - Model FCG20510 Only

Before replacing light bulb, **DISCONNECT POWER TO RANGE**.

To replace fluorescent surface light: Grasp the top of backguard with thumbs under front edge and gently pull outward while lifting to release trim from catches at each end.

Remove bulb and replace with an 18 watt fluorescent tube. Snap top trim back into place, restore power and reset clock.

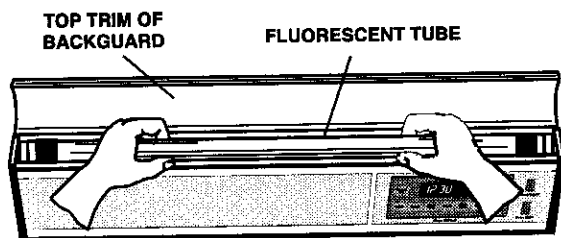

Storage Drawer

The storage drawer at the bottom of the range is safe and convenient for storing metal glass cookware. Do NOT store plastic, paperware, food or flammable material in this drawer. Remove drawer to clean under range.

To remove: Empty drawer then pull drawer out to the first stop position. Lift up front of drawer and pull to the second stop position. Grasp sides and lift up and out to remove drawer.

To replace: Fit ends of drawer glides onto rails. Lift up drawer front and gently push in to first stop position. Lift up drawer again and continue to slide drawer to the closed position.

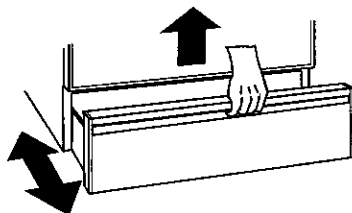

Leveling Legs

Some floors are not level. For proper baking, your range must be level. Leveling legs are located on each corner of the base on the range. Level by turning the legs.

To prevent range from accidentally tipping, range should be secured to the floor by sliding rear leveling leg into the anti-tip bracket supplied with the range.

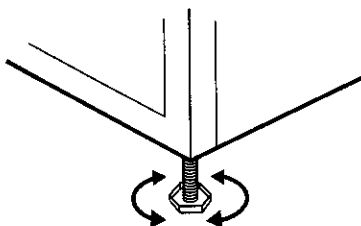

Adjusting Oven Temperature

The oven temperature can be adjusted if the oven temperature is too low or too high and the length of time to cook ALL foods is too long or too short. DO NOT adjust the temperature if only one or two items are not baking properly.

To adjust the oven temperature:

1. Touch **Bake Pad**.
2. Touch and hold the **Up Arrow Pad** until 500° or higher appears in the Display.
3. Immediately, touch and hold the **Bake Pad** for several seconds until 00° appears in the display.
4. Touch the **Up or Down Arrow Pads** to select the temperature change desired. The oven temperature can be increased up to 35° or reduced by as much as 35° (display would show -35°) in 5° increments.
5. Press the **Cancel/Off Pad** and the time of day will reappear in the display. The oven will now bake at the adjusted temperature.

Note: It is not necessary to readjust the oven temperature if there is a power interruption.

Important: The oven temperature should be adjusted no more than 10° and then the oven should be tested. (We recommended baking 2-9" yellow layer cakes using a purchased box mix.) If the oven temperature is still too low or too high, repeat the procedure described above.

Service Information

Check the following list to be sure a service call is really necessary.

If surface burner fails to light:

- check to be sure unit is properly connected to power supply.
- check for a blown circuit fuse or a tripped main circuit breaker.
- check to be sure burner is correctly rated for your type of gas.
- check to be sure burner ports or ignition ports are not clogged.
- check to be sure igniter is dry and clicking. Burner will not light if igniter is damaged, soiled or wet. If igniter doesn't click, turn control knob OFF.

If the flame is uneven:

- burner ports may be clogged.
- flame setting may need to be adjusted.

If surface burner flame lifts off the ports:

- check to be sure a pot is sitting on the grate above.
- contact an authorized Jenn-Air Service Contractor.

If surface burner flame is yellow in color:

- contact an authorized Jenn-Air Service Contractor.

If nothing on the range operates:

- check for a blown circuit fuse or a tripped main circuit breaker.
- check if range is properly connected to electric circuit in house.

If clock, indicator words, and/or lights operate but oven does not heat:

- the controls may have been set incorrectly.
- clock controls may be set for delayed start of oven.

If the oven light does not work:

- the light bulb is loose or defective.
- oven light does not work during self-cleaning process.

If oven will not go through self-cleaning process:

- controls may be improperly set.
- door may not be locked.
- check the "Clean" and "Stop" time settings and the current time of day on the clock.

If oven did not clean properly:

- oven may need longer cleaning time.
- excessive spills were not removed prior to self-cleaning process.

If oven door will not unlock:

- oven may not have cooled to safe temperature after self-cleaning process.

If foods do not broil properly:

- the control may not be set properly.
- check rack position.

If baked food is burned or too brown on top:

- food may be positioned incorrectly in oven.
- oven not preheated properly.

If foods bake unevenly:

- the oven may be installed improperly.
- check the oven rack with a level.
- stagger pans, do not allow pans to touch each other or oven wall.
- check instructions for suggested placement of pans on oven rack.

If oven baking results are less than expected:

- the pans being used may not be of the size or material recommended for best results.
- there may not be sufficient room around sides of the pans for proper air circulation in the oven.
- check instructions for preheating, rack position and oven temperature.

If baking results differ from previous oven:

- oven thermostat calibration may differ between old and new ovens. Follow recipe and use and care directions before calling for service since the calibration on the previous oven may have drifted to a too high or too low setting. (See page 37 - Adjusting Oven Temperature.)

If F plus a number appear in the Display:

- these are fault codes. If a fault code appears in display and a continuous beep sounds, push the **Cancel/Off Pad**. If the fault code reappears, disconnect power to the oven and call an authorized Jenn-Air Service Contractor.

If You Need Service

- call the dealer from whom your appliance was purchased or the authorized Jenn-Air Service Contractor listed in the Yellow Pages. Your Jenn-Air Service Contractor can provide better and faster service if you can accurately describe problems and give model and serial number of the appliance. Be sure to retain proof of purchase to verify warranty status. Refer to **WARRANTY** for further information of owner's responsibilities for warranty service.
 - if the dealer or service company cannot resolve the problem, write to Jenn-Air Customer Assistance, c/o Maytag Customer Service, P.O. Box 2370, Cleveland, TN 37320-2370, 1-800-688-1100 (United States and Ontario) or 423-472-3333.
 - use and care manuals, service manuals, and parts catalogs are available from Jenn-Air Customer Assistance, c/o Maytag Customer Service.
- All specifications subject to change by manufacturer without notice.

Free Manuals Download Website

<http://myh66.com>

<http://usermanuals.us>

<http://www.somanuals.com>

<http://www.4manuals.cc>

<http://www.manual-lib.com>

<http://www.404manual.com>

<http://www.luxmanual.com>

<http://aubethermostatmanual.com>

Golf course search by state

<http://golfingnear.com>

Email search by domain

<http://emailbydomain.com>

Auto manuals search

<http://auto.somanuals.com>

TV manuals search

<http://tv.somanuals.com>