

Quick Start Guide



The MiniTower™-II GoTo AltAz Mount #8300-2G



PACKAGE CONTENTS

- Telescope mount (with built-in GPS)
- GoToNova® 8401 hand controller
- 1.5-inch tripod w/leveling screws
- One 10lb (4.5 kg) counterweight
- One counterweight shaft
- One secondary dovetail
- AC adapter (100V-240V)
- 12V DC adaptor cable with car lighter plug
- One 6P4C controller cable
- One USB cable
- Hard travel case

ONLINE CONTENTS *(click under "Support" menu)* www.iOptron.com





- Manuals *(you will need to refer to the full manual for details on set-up and operation).*
- Tips for set up
- Hand controller firmware upgrades (check online for latest version)
- Reviews and feedback from other customers





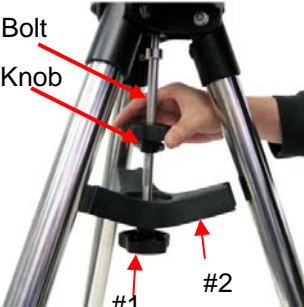

OPTIONAL ACCESSORIES:

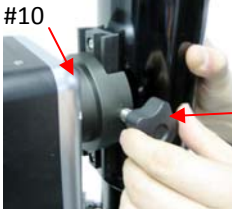





- Losmandy-D saddle (#8426)
- PowerWeight™ rechargeable battery (#8028)
- 2-inch tripod (#8121ACC)
- Pier (#8030M)

Quick Setup

Note: This is a brief outline for getting started. Please refer to the full manual at www.iOptron.com for details.

	<p>Step 1. Extend tripod legs to full extension. Then lock legs using the lock knobs on sides.</p>
	<p>Step 2. Assemble the three prong washer and azimuth clutch lock (#8) onto the mount base. Do not fully tighten the AZI clutch lock yet.</p>
	<p>Step 3. Install three star-shaped adjustment screws onto the tripod head #5. Carefully position telescope mount onto the tripod by aligning the three holes on the bottom of the mount base (#7) to the three level adjustment screws (#6) on the top of the tripod (#5), hold the mount with your hand.</p> <p>Adjust level adjustment screws (#6) to level the mount using the bubble level on the base. Rotate the mount to make sure the bubble is staying in center, or stay in the same place. (An external torpedo level may help.)</p>
	<p>Step 4. Secure the mount to the tripod by using the long tripod bolt (#4). Thread the bolt into the bottom of the mount by turning the tripod knob (#3).</p> <p>Next, slide tripod support spread (#2) onto bottom of bolt (#4). Position the three edges to fit against the three tripod legs. Then hand tighten tripod lock knob (#1) to secure the tripod support spread in place.</p>
	<p>Step 5. Fine adjusting the three level adjustment screws (#6) to further leveling the mount. Tighten the azimuth clutch lock (#8). Tighten the tripod knob (#3). Tighten the tripod lock (#1). Make sure the mount is always leveled.</p>
	<p>Step 6. Attach telescope to Primary Dovetail Saddle (#10) using Primary Dovetail Lock (#9).</p>

	<p>Step 7. Set telescope to PARK POSITION. (1) Position the mount so that the “S” is facing south. (2) The telescope tube should be pointed directly up at the zenith. If it is not perfectly straight then loosen the altitude lock (#12) to adjust telescope. Once it is straight re-tighten the altitude lock to make sure OTA is secure and will not spin.</p>
	<p>Step 8. This step allows you to attach the counterweight or a second scope. (<i>note: if you have a light scope less than 10 lbs. on the primary side, then attaching a counterweight is optional</i>).</p> <p>First, make sure altitude lock (#12) is tightened. Loosen the counterweight shaft lock #13. Tap the center of the primary dovetail and pull the counterweight shaft (#17) out to a desired length. Tighten the counterweight shaft lock #13 to secure it.</p>
	<p><i>If you are attaching a second scope do not add the counterweight. Instead, skip to Step 11 to add a second scope.</i></p> <p>Step 9. Slide the counterweight onto the counterbalance shaft (#17). Insert the brass pin into the hole on the counterweight. Note: when tightened this brass rod should fit into the groove on the shaft.</p>
	<p>Step 10. Secure the counterweight by tightening the lock knob. Again, the counterweight should fit over the groove of the arm so that the brass rod fits into the groove when tightened.</p> <p>Next: Skip to step 12.</p>
	<p><i>This step is for attaching a second scope.</i></p> <p>Step 11. Attach Secondary Dovetail Holder (#14) by tightening the holder lock (#16) onto the counterweight arm (#17).</p> <p>After sliding your scope into the dovetail holder—secure the scope by tightening the secondary lock (#15)</p>
	<p>Step 12. Plug in power plug and hand controller.</p> <p><i>Note: You can also install 8 AA batteries in the side panel. Be sure to use fresh batteries as low batteries can cause error messages to occur.</i></p>

	<p>Step 13. Turn on the mount and wait for controller lights to come on. (For GPS signal, wait for controller to say “GPS OK”—not “GPS ON”).</p> <p>GPS provides Latitude, Longitude, and current GMT time only. If you are not receiving a signal (due to clouds or buildings) you can manually enter the lat. and long. in step 16.</p>
	<p>Step 14. Go to: Set up controller. Press ENTER.</p>
	<p>Step 15. Go to: Set up Local Time. Press ENTER.</p> <p>Enter date and day-light savings (Y=yes. N=no). Then press ENTER (Note: use numbered keypad to change numbers)</p>
	<p>Step 16. Go to: Set Up Site. Press ENTER. Enter time zone: (add or subtract 60 minutes per time zone) Enter minutes “behind” UT or “ahead” of UT</p> <ul style="list-style-type: none"> • New York City is 300 minutes “behind” UT • Los Angeles is 480 minutes “behind” UT • Rome is 60 minutes “ahead” of UT • Sydney is 600 minutes “ahead” of UT
	<p>Step 17. Select and Slew to an object The mount is now ready to GOTO and track objects.</p> <p>Go to: Menu>Select and Slew Press ENTER.</p>
	<p>Step 18. Select a category (ex. “planets, sun, moon”). Then select an object (ex. “moon”). Then press ENTER.</p> <p>The telescope will automatically slew to the object and lock on. It will automatically begin to track once it locks on to the object.</p>
	<p>Step 19. Sync to Target (Use this to center and synchronize the object from Step 18 into the memory). Go to: MENU>Sync. To Target. Press ENTER. Next use the arrow keys to slew to the object until it is centered in your eyepiece. Then press ENTER again on the hand controller. To slew to other objects repeat steps 17 and 18. You do not need to repeat step 18 except for adjustments. (Refer to the online manual for 1-star and 2-star alignments. Sync to Target is the same as 1-star Alignment except that you choose the object to align to.)</p>

Additional Features/Tips

Anti Cord Wrapping

Select "A/A mount Azi mode" for anti-cord wrapping function.

Mount Mode/Type

Make sure you hand controller is working at A/A mode. If not, change the mount type to AltAz (under "Set up controller" go to "mount type")

Error message?: DEC/RA Overcurrent

Check your OTA balance and/or power supply first.

Mount does not move while press an arrow button

Press number 9 to change the slew speed to MAX.

Stop/0

The Stop button is used to stop the tracking. It does not stop slewing. To stop the slewing press the "back" button.

MiniTower II Components

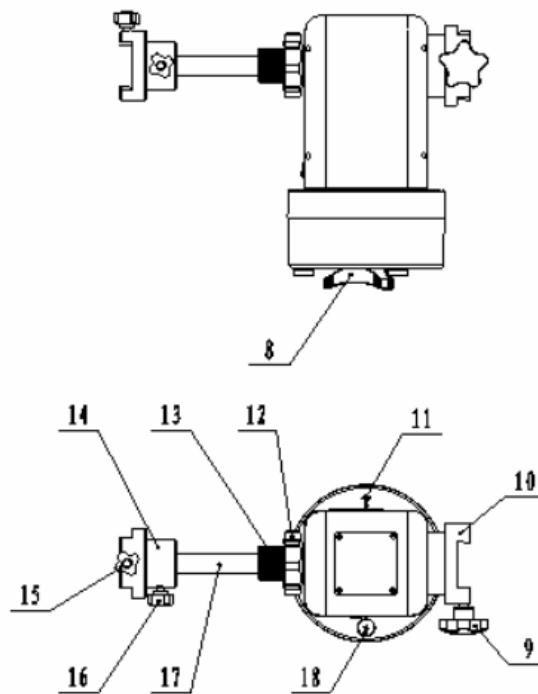
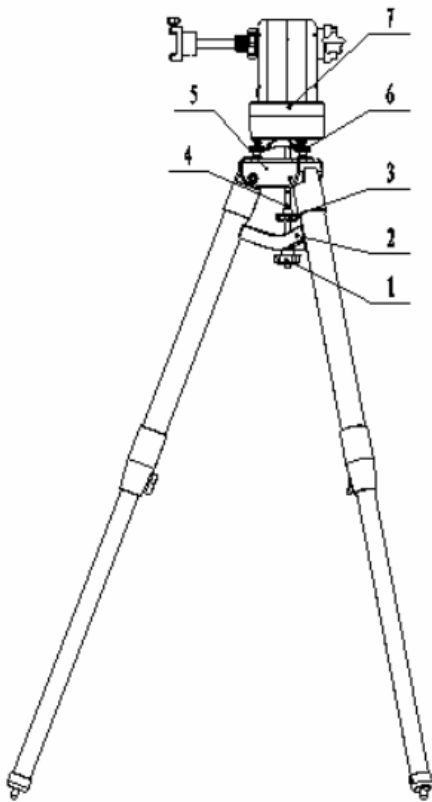

- | | |
|---------------------------|------------------------------------|
| 1. Tripod Lock | 10. Primary Dovetail Saddle |
| 2. Tripod Support Spread | 11. South Mark |
| 3. Tripod Knob | 12. Altitude Lock |
| 4. Tripod Bolt | 13. Counterweight Shaft Lock |
| 5. Tripod Head | 14. Secondary Dovetail Saddle |
| 6. Level Adjustment Screw | 15. Secondary Dovetail Saddle Lock |
| 7. Mount Base | 16. Secondary Dovetail Lock |
| 8. Azimuth Lock | 17. Counterweight Shaft |
| 9. Primary Dovetail Lock | 18. Bubble Indicator |

IOPTRON TWO YEAR TELESCOPE, MOUNT, AND CONTROLLER WARRANTY

A. iOptron warrants your telescope, mount, or controller to be free from defects in materials and workmanship for two years. iOptron will repair or replace such product or part which, upon inspection by iOptron, is found to be defective in materials or workmanship. As a condition to the obligation of iOptron to repair or replace such product, the product must be returned to iOptron together with proof-of-purchase satisfactory to iOptron.

B. The Proper Return Authorization Number must be obtained from iOptron in advance of return. Call iOptron at 1.866.399.4587 to receive the number to be displayed on the outside of your shipping container. All returns must be accompanied by a written statement stating the name, address, and daytime telephone number of the owner, together with a brief description of any claimed defects. Parts or product for which replacement is made shall become the property of iOptron.

The customer shall be responsible for all costs of transportation and insurance, both to and from the factory of iOptron, and shall be required to prepay such costs.

iOptron shall use reasonable efforts to repair or replace any telescope, mount, or controller covered by this warranty within thirty days of receipt. In the event repair or replacement shall require more than thirty days, iOptron shall notify the customer accordingly. iOptron reserves the right to replace any product which has been discontinued from its product line with a new product of comparable value and function.

This warranty shall be void and of no force of effect in the event a covered product has been modified in design or function, or subjected to abuse, misuse, mishandling or unauthorized repair. Further, product malfunction or deterioration due to normal wear is not covered by this warranty.

IOPTRON DISCLAIMS ANY WARRANTIES, EXPRESS OR IMPLIED, WHETHER OF MERCHANTABILITY OF FITNESS FOR A PARTICULAR USE, EXCEPT AS EXPRESSLY SET FORTH HERE. THE SOLE OBLIGATION OF IOPTRON UNDER THIS LIMITED WARRANTY SHALL BE TO REPAIR OR REPLACE THE COVERED PRODUCT, IN ACCORDANCE WITH THE TERMS SET FORTH HERE. IOPTRON EXPRESSLY DISCLAIMS ANY LOST PROFITS, GENERAL, SPECIAL, INDIRECT OR CONSEQUENTIAL DAMAGES WHICH MAY RESULT FROM BREACH OF ANY WARRANTY, OR ARISING OUT OF THE USE OR INABILITY TO USE ANY IOPTRON PRODUCT. ANY WARRANTIES WHICH ARE IMPLIED AND WHICH CANNOT BE DISCLAIMED SHALL BE LIMITED IN DURATION TO A TERM OF TWO YEARS FROM THE DATE OF ORIGINAL RETAIL PURCHASE.

Some states do not allow the exclusion or limitation of incidental or consequential damages or limitation on how long an implied warranty lasts, so the above limitations and exclusions may not apply to you.

This warranty gives you specific legal rights, and you may also have other rights which vary from state to state.

iOptron reserves the right to modify or discontinue, without prior notice to you, any model or style telescope.

If warranty problems arise, or if you need assistance in using your telescope, mount, or controller contact:

iOptron Corporation
Customer Service Department
6E Gill Street
Woburn, MA 01801
www.ioptron.com
e-mail: support@ioptron.com
Tel. (781)569-0200
Fax. (781)935-2860
Monday-Friday 9AM-5PM EST

NOTE: This warranty is valid to original U.S.A. and Canadian customers who have purchased this product from an authorized iOptron dealer in the U.S.A. or Canada or directly from iOptron. Warranty outside the U.S.A. and Canada is valid only to customers who purchased from an iOptron Distributor or Authorized iOptron Dealer in the specific country. Please contact them for any warranty.

Free Manuals Download Website

<http://myh66.com>

<http://usermanuals.us>

<http://www.somanuals.com>

<http://www.4manuals.cc>

<http://www.manual-lib.com>

<http://www.404manual.com>

<http://www.luxmanual.com>

<http://aubethermostatmanual.com>

Golf course search by state

<http://golfingnear.com>

Email search by domain

<http://emailbydomain.com>

Auto manuals search

<http://auto.somanuals.com>

TV manuals search

<http://tv.somanuals.com>