

# OWNER'S MANUAL



## **MX650-CCX / MX770-CCX**

### Cockpit Coaxial Speaker Systems

*Thank you for purchasing a JL Audio Marine Coaxial Speaker System.*

*With proper installation, your new speakers will deliver  
years of listening pleasure.*

*We strongly recommend that you have your new marine speakers  
installed by your authorized JL Audio dealer.*

*The installation professionals employed by your dealer have  
the necessary tools and experience to properly install your new speakers.*

*If you prefer to perform your own installation,  
please read this instruction manual completely before  
beginning the process.*



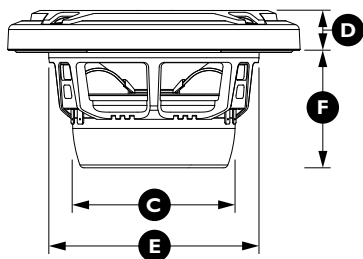
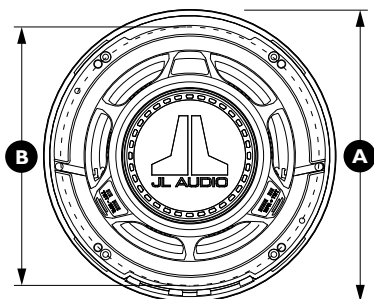

Physical Specifications	MX650-CCX	MX770-CCX
<b>Nominal Diameter</b>	6.5 in. / 165 mm	7.7 in. / 196 mm
<b>Grille Outer Diameter (A)</b>	6.90 in. / 175 mm	7.7 in. / 196 mm
<b>Bolt Hole Circle (B)</b>	6.125 in. / 156 mm	6.92 in. / 176 mm
<b>Motor Overmold Outer Diameter (C)</b>	3.85 in. / 98 mm	4.27 in. / 108 mm
<b>Frontal Grille Protrusion* (D)</b>	0.97 in. / 25 mm	1.00 in. / 25 mm
<b>Mounting Hole Diameter (E)</b>	5.00 - 5.25 in. / 127-133 mm	6.25 in. / 159 mm
<b>Mounting Depth (F)</b>	2.74 in. / 70 mm	3.15 in. / 80 mm

Notes: \*Frontal grille protrusion measured from mounting surface

Specifications	MX650-CCX	MX770-CCX
<b>Mounting Application</b>	Cockpit (Infinite Baffle)	Cockpit (Infinite Baffle)
<b>Continuous Power Handling (RMS Method)</b>	60 Watts / channel	70 Watts / channel
<b>Frequency Response</b>	55 Hz - 25 KHz (± 3 dB)	45 Hz - 25 KHz (± 3 dB)
<b>Efficiency @ 1W/1m</b>	89.0 dB	90.5 dB
<b>Nominal Impedance</b>	4 ohms	4 ohms

## MARINE SPEAKER SPECIFICATIONS

**Woofers:** Injection-molded, mica-filled polypropylene cone bodies with UV inhibitors, 1.00-inch (25 mm) voice coils on MX650-CCX and 1.27-inch (32 mm) voice coils on MX770-CCX, low-profile/ progressive-roll spiders and synthetic rubber surrounds. DMA-optimized, long excursion design for enhanced output and bass response. UV-resistant polymer baskets and grilles

**Tweeters:** 0.75-inch (19 mm) treated silk dome tweeter, neodymium magnet, ferrofluid cooled and damped.

**Crossover Networks:** Natural woofer roll-off with 2nd order high-pass circuits. Polyswitch solid-state tweeter protection

### Included Components and Parts:

- Two Coaxial Speaker Systems
- Two Polymer Woofer Grilles (attached to speaker)
- Two 0.75-inch (19 mm) Tweeters (mounted to grilles)
- Two 2nd order high-pass filters (mounted to grilles)
- Eight #8 x 1 3/8-inch (35 mm) phillips-head stainless-steel screws for speaker mounting
- Eight #8 stainless-steel washers for speaker mounting
- Mounting Template

Due to ongoing product development, all specifications are subject to change without notice.

**CCX AND TCX MODELS...  
WHAT IS THE DIFFERENCE?**

CCX models have woofers specifically designed for infinite-baffle applications. In plain english, this means that they are designed to operate without an enclosure behind them. The bass response of the speaker will suffer significantly if placed in a small enclosure.

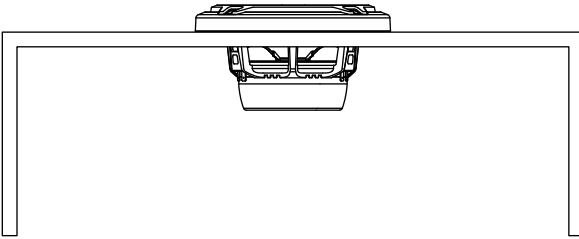

TCX models are specifically engineered for enclosed operation. This makes them ideal for wakeboard tower systems or other small enclosure applications.

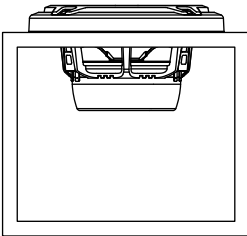

**⚠ WARNING**

Do not attempt to remove the tweeter from the grille or the grille from the speaker! The tweeter is permanently fixed to the grille and its wiring is permanently attached to the speaker frame. Attempting to remove the grille or the tweeter will damage the speaker and this damage will not be covered under warranty.

## BEFORE YOU BEGIN INSTALLING

- Turn off the audio system. It is also advisable to disconnect your battery system whenever performing installation work.
- Before cutting, drilling or inserting any screw, check clearances on both sides of the planned mounting surface. Also check for any potential obstacles, such as wiring harnesses, fuel lines, hydraulic lines, etc. Check both sides of the vessel before cutting any holes.
- Wear protective eyewear at all times and a dust mask and gloves when drilling or cutting.

## !!! WARNING

It is absolutely vital that your coaxial speaker system is connected as shown in this manual. Failure to connect the system as shown will result in damage to your speakers which is NOT covered under warranty. Do not substitute different crossover networks!

## !!! CAUTION

While these speakers are designed to be water and spray resistant, they are not designed to be submerged or to withstand high-pressure water spray. Please exercise care when washing your boat to avoid damaging your speakers. Do not install on submersibles, personal watercraft or any other vessel likely to be under water at any time.

Prolonged exposure to sound pressure levels in excess of 100dB can cause permanent hearing loss. This high-performance speaker can exceed this level. Please exercise restraint in its operation in order to preserve your ability to enjoy its fidelity.

When installing speakers in your vessel, it is extremely important to secure them firmly. This applies not only to the speakers themselves, but also any structure they are mounted to. If not firmly attached, the speakers can become dangerous projectiles in a collision. Please review the mounting information carefully and use the supplied marine-grade hardware to mount this product.

## TWEETER PROTECTION

The crossover networks are equipped with an advanced electronic tweeter protection circuit designed to minimize the possibility of tweeter failure. This electronic device monitors current going to the tweeter and will disconnect the tweeter from the signal when it senses overload. Should this occur while listening to the audio system, simply reduce the volume for a few seconds and the protection circuit will reset itself automatically.

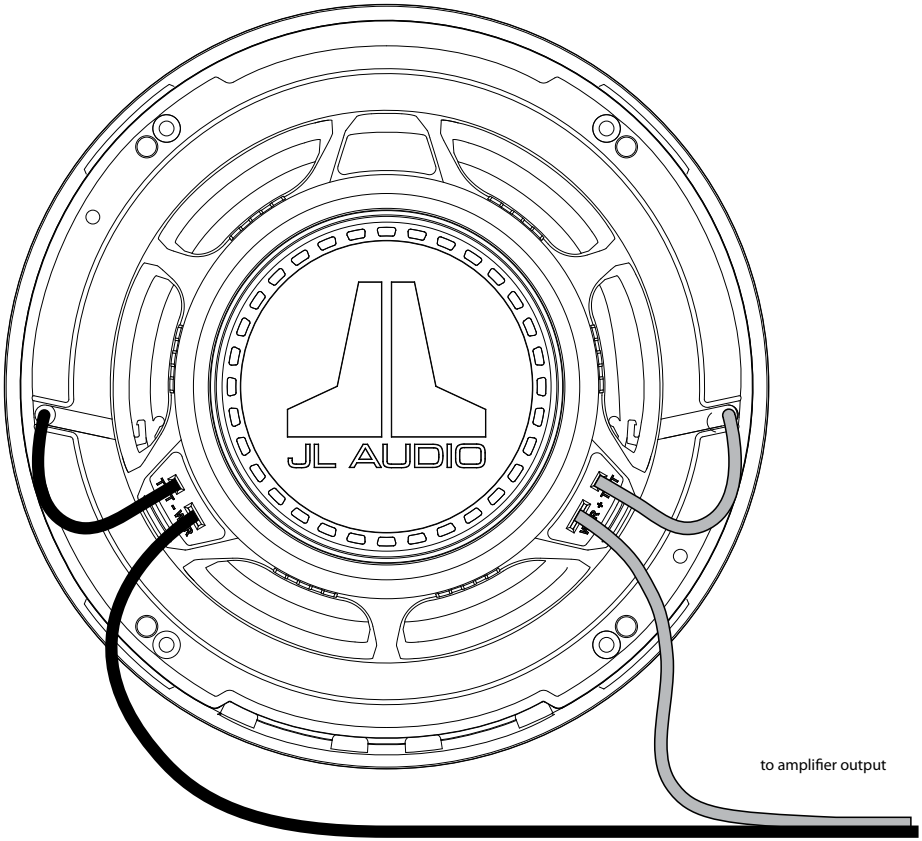

**WIRING DIAGRAM:**

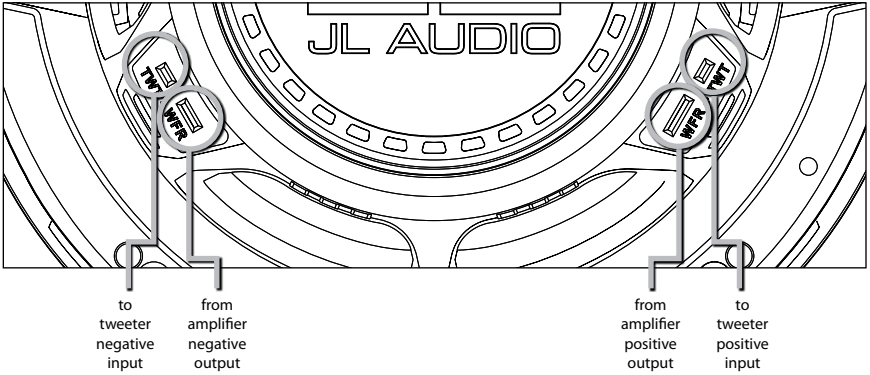

## INSTALLING THE SPEAKERS

Once the mounting locations have been established, run speaker cables from the amplifier outputs to the mounting locations. If you are running cables through bulkheads, drill holes for the cable and use a urethane or plastic grommet to protect the wire from chafing in the hole. Make sure that the cables will clear any mechanical devices in the boat and secure them with wire ties.

If you have any questions about the installation or setup of your coaxial speaker system not covered in this manual, please contact your dealer or technical support.

### **JL Audio Technical Support:**

(954) 443-1100

9:00 AM – 5:30 PM (Eastern Time Zone)

Monday - Friday

## COAXIAL INSTALLATION PROCEDURE

Diagram A (page 7) shows the typical installation procedure into a fiberglass panel, using the supplied hardware. Always follow proper safety procedures. Use eye-protection at all times and a dust mask and gloves when cutting.

- 1) Choose a flat mounting surface that has sufficient depth and air space behind it to accept the speaker.
- 2) Using a hole saw or jigsaw, cut a mounting hole for your respective speaker model (see “Mounting Hole Diameter (E)” specifications, page 2). If using a jigsaw, tracing the supplied mounting template will provide you with an accurate line on which to cut.
- 3) Run the speaker cable from the amplifier output to the mounting location.
- 4) Place the speaker in the hole (or use the mounting template) and mark the screw hole locations using a sharp, pointed tool.
- 5) Remove the speaker and drill a pilot hole (see Pilot Hole Recommendation chart, page 7) in each of the screw locations. It is also advisable to use a hand-driven countersink tool on each hole to further inhibit gel-coat cracking of fiberglass panels.
- 6) Connect the speaker wires from the amplifier to the woofer connections. See Wiring Diagram on page 5.
- 7) Place the speaker into the opening.
- 8) While holding the speaker firmly in its mounting location, place the #8 x 1 3/8-inch Phillips pan-head mounting screws (with washers) and snug in a criss-cross pattern, then tighten with a hand screwdriver in a criss-cross pattern.

Non-standard installations may require different hardware. Always use marine-grade, stainless-steel fasteners to ensure a secure, reliable installation.

## DIAGRAM A

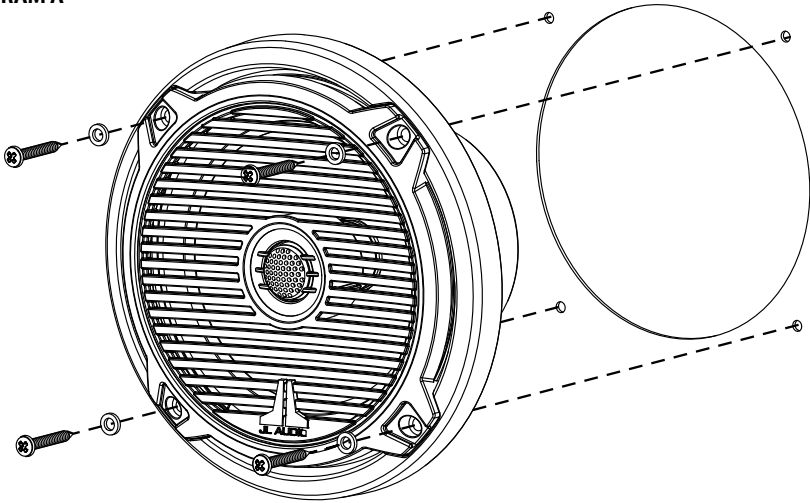

### #8 SCREW: PILOT HOLE RECOMMENDATIONS

Fiberglass Thickness	Recommended Pilot Hole Drill Size
0.125 in. (3.18 mm) or less	7/64 in. (2.78 mm) pilot hole
foam core / fiberglass sandwich	7/64 in. (2.78 mm) pilot hole
larger than 0.125 in. (3.18 mm)	1/8 in. (3.18 mm) pilot hole

### **!! WARNING**

Do not attempt to remove the tweeter from the grille or the grille from the speaker!

The tweeter is permanently fixed to the grille and its wiring is permanently attached to the speaker frame. Attempting to remove the grille or the tweeter will damage the speaker and this damage will not be covered under warranty.

## LIMITED WARRANTY - MARINE SPEAKER SYSTEMS (USA)

JL AUDIO warrants this product to be free of defects in materials and workmanship for a period of two (2) years from the original date of purchase.

This warranty is not transferable and applies only to the original purchaser from an authorized JL AUDIO dealer. Should service be necessary under this warranty for any reason due to manufacturing defect or malfunction, JL AUDIO will (at its discretion), repair or replace the defective product with new or remanufactured product at no charge.

Damage caused by the following is not covered under warranty: accident, misuse, abuse, product modification or neglect, failure to follow installation instructions, unauthorized repair attempts, misrepresentations by the seller. This warranty does not cover incidental or consequential damages and does not cover the cost of removing or reinstalling the unit(s). Cosmetic damage due to accident or normal wear and tear is not covered under warranty.

### **Warranty is void if the product's serial number has been removed or defaced.**

Any applicable implied warranties are limited in duration to the period of the express warranty as provided herein beginning with the date of the original purchase at retail, and no warranties, whether express or implied, shall apply to this product thereafter. Some states do not allow limitations on implied warranties, therefore these exclusions may not apply to you. This warranty gives you specific legal rights, and you may also have other rights which vary from state to state.

### **If you need service on your JL AUDIO product:**

All warranty returns should be sent to JL AUDIO freight prepaid through an authorized JL AUDIO dealer and must be accompanied by proof of purchase (a copy of the original sales receipt.) Direct returns from consumers or non-authorized dealers will be refused unless specifically authorized by JL AUDIO with a valid return authorization number. Warranty expiration on products returned without proof of purchase will be determined from the manufacturing date code. Coverage may be invalidated as this date is previous to purchase date. Return only defective components. If one speaker fails in a system, return only that speaker component, not the entire system. Non-defective items received will be returned freight-collect. Customer is responsible for shipping charges and insurance in sending the product to JL AUDIO. Freight damage on returns is not covered under warranty.

### **For Service Information in the U.S.A. please call**

**JL Audio Customer Service:** (954) 443-1100

9:00 AM – 5:30 PM (Eastern Time Zone)

**JL Audio, Inc**

10369 North Commerce Pkwy.

Miramar, FL 33025

### **International Warranties:**

Products purchased outside the United States of America are covered only by that country's distributor and not by JL Audio, Inc.



## Free Manuals Download Website

<http://myh66.com>

<http://usermanuals.us>

<http://www.somanuals.com>

<http://www.4manuals.cc>

<http://www.manual-lib.com>

<http://www.404manual.com>

<http://www.luxmanual.com>

<http://aubethermostatmanual.com>

Golf course search by state

<http://golfingnear.com>

Email search by domain

<http://emailbydomain.com>

Auto manuals search

<http://auto.somanuals.com>

TV manuals search

<http://tv.somanuals.com>