

# JVC

English

中文

## MICRO COMPONENT MD SYSTEM

MD 微型组合音响

# UX-A10DVD

—Consists of CA-UXA10DVD and SP-UXA10DVD

—由 CA-UXA10DVD 及 SP-UXA10DVD 组成

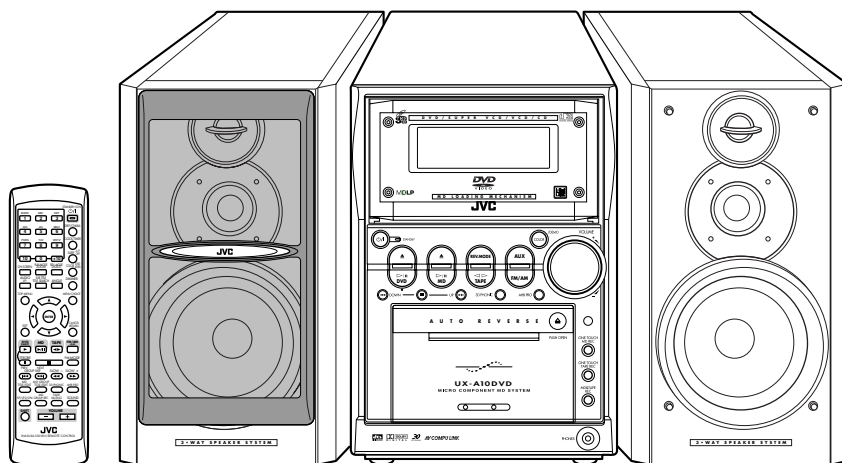

## INSTRUCTIONS 使用说明书

### For Customer Use:

Enter below the Model No. and Serial No. which are located either on the rear, bottom or side of the cabinet. Retain this information for future reference.

Model No. \_\_\_\_\_

Serial No. \_\_\_\_\_

LVT0954-002A  
[UB]

# Warnings, Cautions and Others

## 警告，注意及其他须知事项

### Caution— button!

Disconnect the mains plug to shut the power off completely. The  button in any position does not disconnect the mains line. The power can be remote controlled.

### 注意— 开关！

无论  开关在任何位置，电源线的电源还是没有被切断，若要将电源完全关闭，应把电源插头拔离插座。电源可用遥控器控制。

#### CAUTION

To reduce the risk of electrical shocks, fire, etc.:

1. Do not remove screws, covers or cabinet.
2. Do not expose this appliance to rain or moisture.

#### 注意

为了减少触电，火灾等危险：

1. 请勿擅自卸下螺丝钉，盖子或机壳。
2. 请勿让本机受雨淋或置潮湿环境中。

#### CAUTION

- Do not block the ventilation openings or holes. (If the ventilation openings or holes are blocked by a newspaper or cloth, etc., the heat may not be able to get out.)
- Do not place any naked flame sources, such as lighted candles, on the apparatus.
- When discarding batteries, environmental problems must be considered and local rules or laws governing the disposal of these batteries must be followed strictly.
- Do not expose this apparatus to rain, moisture, dripping or splashing and that no objects filled with liquids, such as vases, shall be placed on the apparatus.

#### 注意

- 请勿堵塞通风口或通风孔。  
(如果通风口或通风孔被报纸或布等堵塞，热量将无法散出。)
- 请勿在本设备上放置任何裸露的火源，如点燃的蜡烛。
- 处理废弃电池时，必须考虑环境问题，并严格遵守当地关于处理废弃电池的有关法律或规定。
- 切勿将本装置暴露于雨水所及、潮湿、滴水或易于溅起水花的地方，亦不要将任何装满液体的物件（如花瓶）放置在本装置上。

### Caution: Proper Ventilation

To avoid risk of electric shock and fire, and to prevent damage, locate the apparatus as follows:

- 1 Front: No obstructions and open spacing.
- 2 Sides/ Top/ Back: No obstructions should be placed in the areas shown by the dimensions below.
- 3 Bottom: Place on the level surface. Maintain an adequate air path for ventilation by placing on a stand with a height of 10 cm or more.

#### 注意：正确通风

为免发生触电和火警的危险，及防止本机受损，请将本机如下放置：

1. 前面： 没有障碍物及地方开阔。
2. 侧面/顶面/背面： 在图中所示范围中，不应放置任何障碍物。
3. 底部： 放置在水平面上。放置在一个高 10 厘米或以上的台上，以保持足够的通风道。

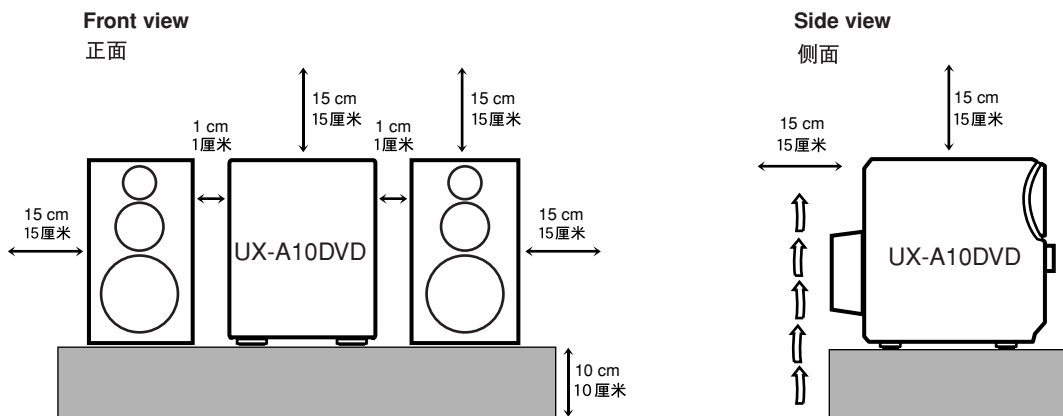

## IMPORTANT FOR LASER PRODUCTS / 镭射产品的重要说明

---

### REPRODUCTION OF LABELS / 说明文抄录

#### ① CLASSIFICATION LABEL ON EXTERIOR SURFACE

##### ① 位于机表的分类说明文

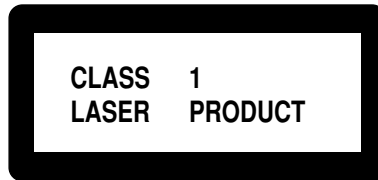

#### ② WARNING LABEL INSIDE THE UNIT

##### ② 位于机内的警告说明文

**CAUTION** : Visible and invisible laser radiation when open and interlock failed or defeated. AVOID DIRECT EXPOSURE TO BEAM. (e)

**ADVARSEL** : Synlig og usynlig laserstråling når maskinen er åben eller interlocken fejler. Undgå direkte eksponering til stråling. (d)

**VARNING** : Synlig och osynlig laserstråling när den öppnas och spärren är urkopplad. Betrakta ej strålen. (s)

**VARO** : Avattaessa ja suojalukitus ohitettuna tai viallisena olet alttiina näkyvälle ja näkymättömälle lasersäteilylle. Vältä säteen kohdistumista suoraan itseesi. (f)

1. CLASS 1 LASER PRODUCT
2. **CAUTION**: Visible and invisible laser radiation when open and interlock failed or defeated. Avoid direct exposure to beam.
3. **CAUTION**: Do not open the top cover. There are no user serviceable parts inside the unit; leave all servicing to qualified service personnel.

1. 一级雷射产品
2. **注意**：当内部锁定装置失效或者损坏后，打开盖板可能会产生可见或不可见的雷射辐射。应避免受到雷射光线的直接照射。
3. **注意**：请勿打开顶盖板。本机内部没有用户可自行维修的部件；所有维修工作应由有资格的人员完成。



# Introduction

We would like to thank you for purchasing one of our JVC products. Before operating this unit, read this manual carefully and thoroughly to obtain the best possible performance from your unit, and retain this manual for future reference.

## About This Manual

This manual is organized as follows:

- This manual mainly explains playback and editing operations using the remote control, and other operations such as recording using the buttons on the main unit. You can use the buttons both on the remote control and on the main unit for the same operations if they have the same or similar names (or marks), unless mentioned otherwise.
- Basic and common information that is the same for many functions is grouped in one place, and is not repeated for each procedure. For instance, we do not repeat the information about turning on/off the unit, setting the volume, changing the sound effects, and others, which are explained in the section “Basic and Common Operations” on pages 18 to 23.
- The following symbols are used in this manual:

	<p>Gives you warning and caution to prevent damage or risk of fire/electric shock. Furthermore, gives you information which is not good for obtaining the best possible performance from the unit.</p>
	<p>Gives you information and hints you had better know.</p>

## Precautions

### Installation

- Install in a place which is level, dry and neither too hot nor too cold—between 5°C and 35°C.
- The unit is equipped with the cooling fan which makes possible the high-powered operations with the limited space. When the temperature inside the unit increases due to operating the unit at high volume or consecutively, the cooling fan activates to lower the temperature. Install the unit in a location with adequate ventilation to prevent internal heat buildup in the unit.
- Leave sufficient distance between the unit and the TV.

- Although the speakers are magnetically shielded, the TV may be mottled. In this case, keep the distance from the speakers to the TV until the speakers does not affect the TV.



DO NOT install the unit in a location near heat sources, or in a place subject to direct sunlight, excessive dust or vibration.

### Power sources

- When unplugging the unit from the wall outlet, always pull on the plug, not the AC power cord.



DO NOT handle the AC power cord with wet hands.

### Moisture condensation

Moisture may condense on the lenses inside the unit in the following cases:

- After starting to heat the room
  - In a damp room
  - If the unit is brought directly from a cold to a warm place
- Should this occur, the unit may malfunction. In this case, leave the unit turned on for a few hours until the moisture evaporates, unplug the AC power cord, then plug it in again.

### Others

- The electronic swing panel may malfunction when you use this unit under intense light such as sunlight.



DO NOT expose this unit to intense light.

- Should any metallic object or liquid fall into the unit, unplug the AC power cord and consult your dealer before operating any further.
- If you are not going to operate the unit for an extended period of time, unplug the AC power cord from the wall outlet.



DO NOT disassemble the unit since there are no user serviceable parts inside.

If anything goes wrong, unplug the AC power cord and consult your dealer.

# Contents

<b>Location of the Buttons and Controls .....</b>	<b>3</b>	Selecting the Multi-Angle Views .....	52
<b>About Discs .....</b>	<b>6</b>	Selecting the Audio Language or Sound .....	53
Playable Disc Types .....	6	Selecting the Subtitle Language .....	53
Disc structure .....	7	Playing a Still Picture/Frame-by-Frame .....	54
<b>Getting Started .....</b>	<b>8</b>	Showing Continuous Still Pictures—Strobe .....	54
Unpacking .....	8	Playing Back in Slow-Motion—Slow .....	54
Putting the Batteries into the Remote Control .....	8	Zooming in the Picture—Zoom .....	55
Connecting Antennas .....	8	Enjoying Virtual Surround Sound—3D PHONIC .....	55
Connecting Speakers .....	9	<b>Recording .....</b>	<b>56</b>
Connecting a TV .....	10	Before You Start Recording on an MD .....	57
Connecting Other Equipment .....	11	Setting MD Recording Modes .....	59
Setting the DVD Player .....	13	Recording a Disc onto an MD	
Setting the Clock .....	17	—Disc Synchronized Recording .....	59
<b>Basic and Common Operations .....</b>	<b>18</b>	Recording Other Sources onto an MD .....	61
Turning On the Power .....	19	Before You Start Recording on a Tape .....	62
Selecting the Sources and Starting Play .....	20	Recording onto a Tape .....	63
Adjusting the Volume .....	20	Recording a Disc onto an MD and a Tape	
Reinforcing the Bass Sound .....	21	—Disc Synchronized Recording .....	64
Selecting the Sound Modes .....	21	<b>Editing MDs .....</b>	<b>65</b>
Changing the Display Illumination .....	22	Guidance—MD Group Functions .....	66
Adjusting the Audio Input Level .....	23	Introducing Group Editing Functions .....	67
Prohibiting Disc Ejection .....	23	Forming a Group—FORM GR .....	68
<b>Listening to FM and AM Broadcasts .....</b>	<b>24</b>	Adding a Track to a Group—ENTRY GR .....	69
Setting the AM Tuner Interval Spacing .....	25	Dividing a Group—DIVIDE GR .....	70
Tuning in to a Station .....	25	Joining Two Groups—JOIN GR .....	71
Presetting Stations .....	26	Moving a Group—MOVE GR .....	72
Tuning in to a Preset Station .....	26	Ungrouping Tracks—UNGROUP .....	73
<b>Playing Back Discs .....</b>	<b>27</b>	Dissolving All Groups—UNGR ALL .....	73
Loading a Disc .....	28	Erasing Tracks in a Group—ERASE GR .....	74
DVD Basic Operations .....	29	Introducing Track Editing Functions .....	75
SVCD/VCD/Audio CD Basic Operations .....	30	Dividing a Track—DIVIDE .....	76
MP3 Basic Operations .....	32	Joining Two Tracks—JOIN .....	77
Searching for a Particular Point .....	33	Moving a Track—MOVE .....	78
Playing Back by Using the Disc Menu .....	34	Erasing Tracks—ERASE .....	79
Repeating Playback .....	35	Erasing All Tracks—ALL ERASE .....	79
Programming the Playing Order—Program Play .....	37	Assigning Titles to an MD .....	80
Playing at Random—Random Play .....	39	<b>Changing the DVD Initial Settings .....</b>	<b>83</b>
<b>Playing Back MDs .....</b>	<b>40</b>	Basic Procedure .....	84
Playing Back the Entire MD .....	41	Changing the Initial Language Settings .....	85
MD Basic Operations .....	41	Changing the Various Audio Settings .....	85
Repeating Tracks—Repeat Play .....	42	Changing the Display Settings .....	86
Programing the Playing Order of the Tracks		Changing the System Settings .....	86
—Program Play .....	43	Limiting Playback of DVD—Parental Lock .....	87
Playing at Random—Random Play .....	44	<b>Using the Timers .....</b>	<b>88</b>
Playing Tracks in a Group—Group Play .....	45	Using the Recording Timer .....	89
Searching for Tracks to Play—MD Title Search .....	46	Using the Daily Timer .....	90
<b>Playing Back Tapes .....</b>	<b>47</b>	Using the Sleep Timer .....	92
Playing Back a Tape .....	48	<b>Using AV COMPU LINK Control System...</b>	<b>93</b>
<b>Special Disc Playback .....</b>	<b>49</b>	<b>Maintenance .....</b>	<b>94</b>
Locating a Scene by Selecting the Chapter Number		<b>Disc/MD Messages .....</b>	<b>95</b>
—Chapter Search .....	50	<b>Troubleshooting .....</b>	<b>97</b>
Locating a Position by Selecting the Playing Time		<b>Table of Language Codes .....</b>	<b>99</b>
—Time Search .....	50	<b>Table of Country/Area Codes .....</b>	<b>100</b>
Viewing the Desired Chapters/Tracks—Digest .....	51	<b>Specifications .....</b>	<b>102</b>

# Location of the Buttons and Controls

Become familiar with the buttons and controls on your unit.

## Main Unit

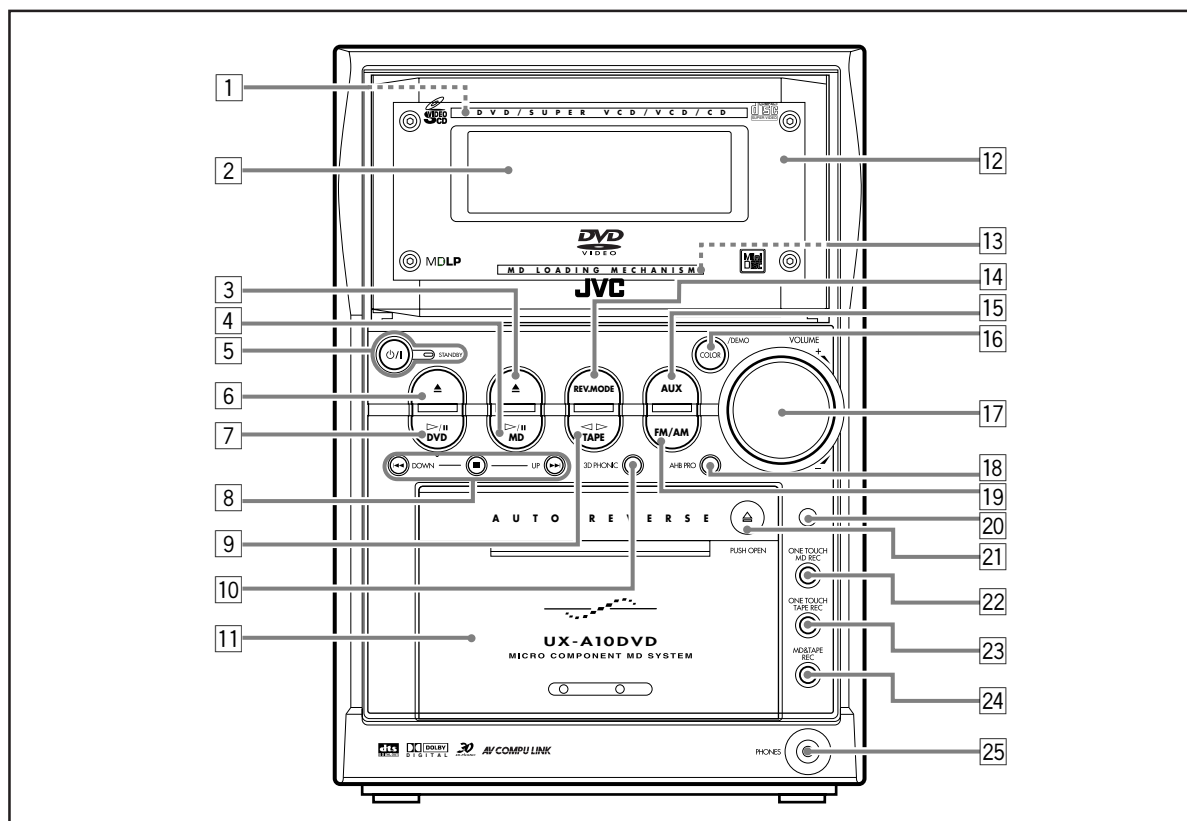

### Main unit

See pages in parentheses for details.

- |  |  |
|--|--|
| 1 Disc tray (inside the electronic swing panel) (28)   | 11 Cassette holder (48)  |
| 2 Display window (4)   | 12 Electronic swing panel  |
| 3 MD ▲ (eject) button (19, 41, 81, 82)<br>• Pressing this button also turns on the unit.   | 13 MD loading slot (inside the electronic swing panel) (41)                      |
| 4 MD ▷/■ (play/pause) button (19, 20, 41)<br>• Pressing this button also turns on the unit.  | 14 REV. MODE button (23, 48, 89)   |
| 5 ○/I (Standby/On) button and STANDBY lamp (19, 25, 90, 91)  | 15 AUX button (19, 20, 23)<br>• Pressing this button also turns on the unit.     |
| 6 DVD ▲ (eject) button (19, 28 – 30, 86, 87)<br>• Pressing this button also turns on the unit.   | 16 COLOR/DEMO button (13, 22)  |
| 7 DVD ▷/■ (play/pause) button (19, 20, 28 – 33, 86)<br>• Pressing this button also turns on the unit.  | 17 VOLUME + / – control (20)   |
| 8 Multi operation buttons<br>• DOWN and UP buttons<br>• ◀◀ (reverse search/fast-wind to the left), ■ (stop) and ▶▶ (forward search/fast-wind to the right) buttons | 18 AHB PRO (Active Hyper Bass Pro) button (21)                                   |
| 9 TAPE ◀▶ (play) button (19, 20, 48)<br>• Pressing this button also turns on the unit.   | 19 FM/AM button (19, 20, 25)<br>• Pressing this button also turns on the unit.   |
| 10 3D PHONIC button (55)   | 20 Remote sensor   |
|  | 21 ▲ (PUSH OPEN) (48)<br>• Push this mark to open and close the cassette holder. |
|  | 22 ONE TOUCH MD REC button (59, 61)  |
|  | 23 ONE TOUCH TAPE REC button (63)  |
|  | 24 MD&TAPE REC button (64)   |
|  | 25 PHONES jack (20)  |

## Display window on the electronic swing panel

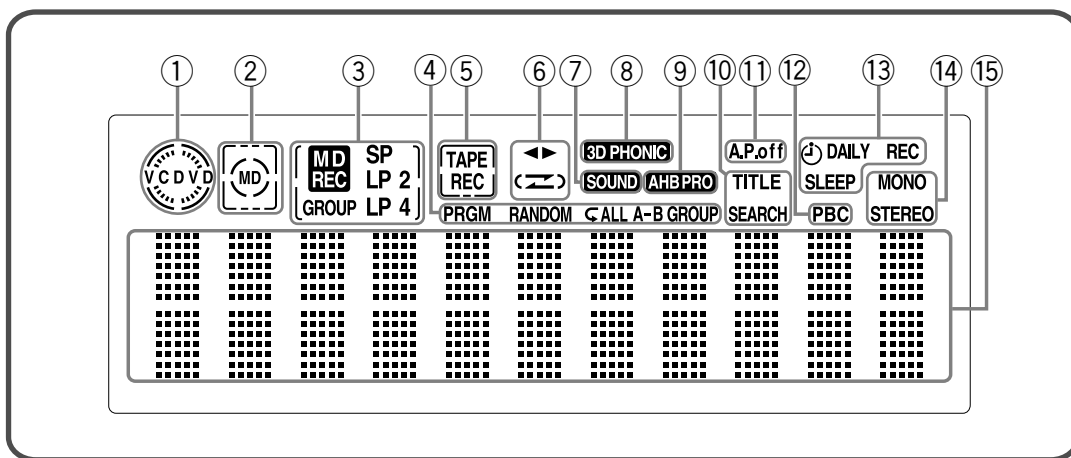

## Display window

See pages in parentheses for details.

- ① Disc indicator (28)
- ② MD indicator (41, 61)
- ③ MD recording indicators
  - MD REC indicator (59 – 61, 64, 68 – 74, 76 – 79, 81, 82)
  - Recording length mode indicators (59)
    - SP, LP2 and LP4
  - GROUP indicator (59)
- ④ Disc/MD play mode indicators (35 – 39, 42 – 45)
  - PRGM (program), RANDOM, Repeat mode (◀, ▶, CALL, CA-B), and GROUP
- ⑤ TAPE indicator (48, 64)
  - REC indicator (63, 64)
- ⑥ Tape operation indicators (48, 63)
  - ◀▶ (tape direction) and ⏮ (reverse mode)
- ⑦ SOUND indicator (21)
- ⑧ 3D PHONIC indicator (55)
- ⑨ AHBPRO (Active Hyper Bass Pro) indicator (21)
- ⑩ TITLE indicator (46)
  - SEARCH indicator (46, 50)
- ⑪ A.P.off (Auto Power off) indicator (19)
- ⑫ PBC indicator (30, 34)
- ⑬ Timer mode indicators
  - ⏰ (timer) (89 – 92)
  - DAILY (Daily Timer) (90, 91)
  - REC (Recording Timer) (89, 90)
  - SLEEP (Sleep Timer) (92)
- ⑭ FM mode indicators (25)
  - STEREO and MONO
- ⑮ Main display
  - Shows the source name and other information.

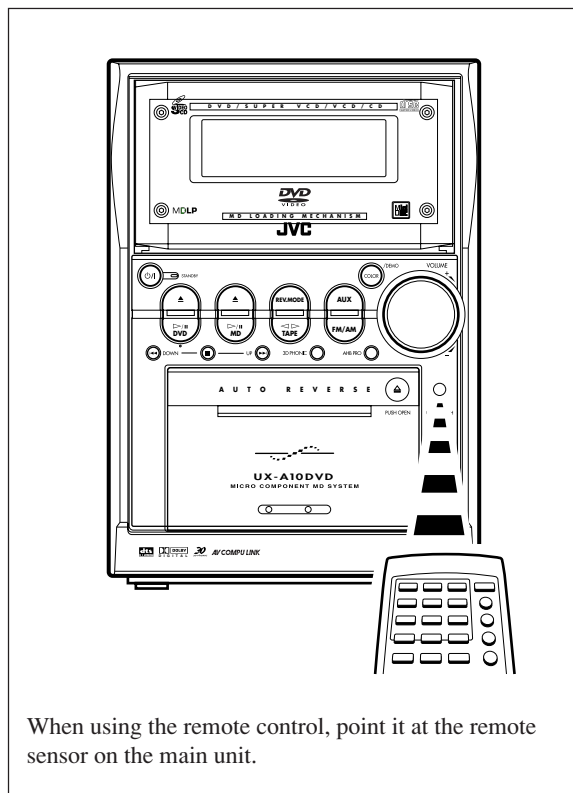

When using the remote control, point it at the remote sensor on the main unit.

## Remote Control

See pages in parentheses for details.

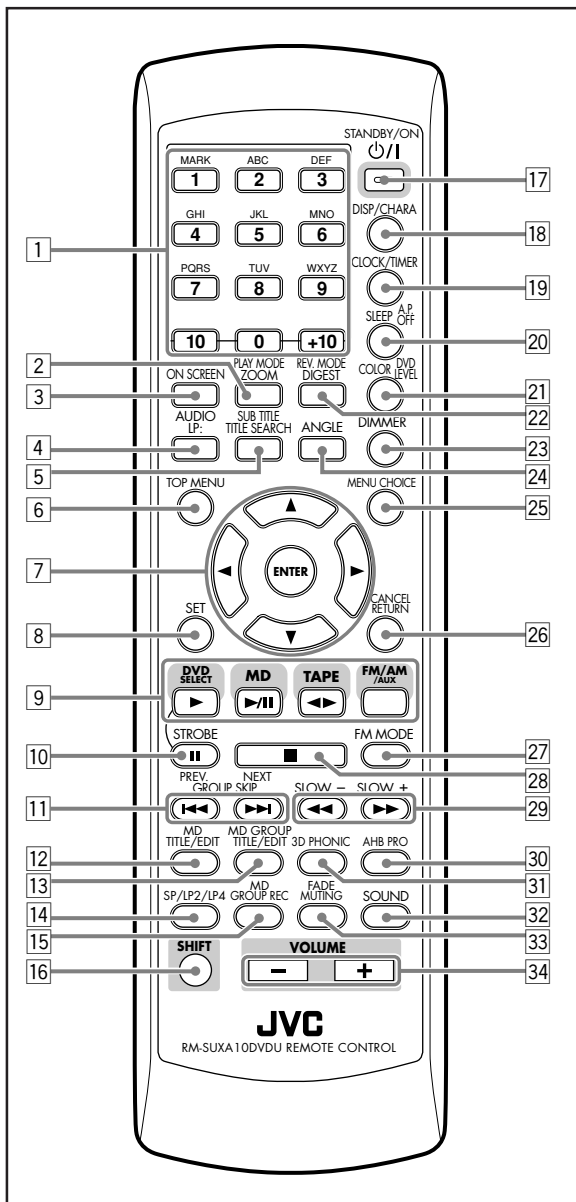

- 1 Number buttons
  - 1 – 10, 0 and +10 buttons
  - Character entry buttons (MARK, A – Z, 0 – 9) (46, 81)
- 2 PLAY MODE button (35 – 39, 42 – 45, 50)  
ZOOM button\* (55)
- 3 ON SCREEN button (29, 31, 33)
- 4 AUDIO button (53)  
LP: button\* (59)
- 5 SUB TITLE button (53)  
TITLE SEARCH button\* (46)
- 6 TOP MENU button (34)
- 7 Cursor ◀/▶/▲/▼ and ENTER buttons
- 8 SET button
- 9 Source selecting buttons
  - DVD SELECT ▶ (play) button (14, 19, 20, 28 – 33, 35, 37, 39, 86)
  - MD ▶/|| (play/pause) button (19, 20, 41, 43 – 46)
  - TAPE ◀▶ (play) button (19, 20, 48)
  - FM/AM/AUX button (19, 20, 23, 25, 26)

*Pressing one of these buttons also turns on the unit.*
- 10 || (pause) button (29, 31, 32, 54)  
STROBE button (54)
- 11 ▶▶ and ◀◀ buttons  
GROUP SKIP ▶▶/|◀◀ buttons\* (33, 45, 69 – 74)  
PREV. and NEXT buttons (34, 51)
- 12 MD TITLE/EDIT button (76 – 80)
- 13 MD GROUP TITLE/EDIT button (68 – 74, 80)
- 14 SP/LP2/LP4 button (59)
- 15 MD GROUP REC button (59, 90)
- 16 SHIFT button
- 17 STANDBY/ON ⏻/⏻ button (19, 90, 91)
- 18 DISP/CHARA (display/character) button (17, 42, 46, 60, 61, 81)
- 19 CLOCK/TIMER button (17, 89 – 91)
- 20 SLEEP button (92)  
A.P.OFF button\* (19)
- 21 COLOR button (13, 22)  
DVD LEVEL button\* (30)
- 22 REV. MODE button (48, 63, 89)  
DIGEST button\* (51)
- 23 DIMMER button (22)
- 24 ANGLE button (52)
- 25 MENU button (34)  
CHOICE button\* (14 – 16, 84)
- 26 CANCEL button  
RETURN button\* (34)
- 27 FM MODE button (25)
- 28 ■ (stop) button
- 29 ▶▶ and ◀◀ buttons  
SLOW + / – buttons (54)
- 30 AHB PRO (Active Hyper Bass Pro) button (21)
- 31 3D PHONIC button (55)
- 32 SOUND button (21)
- 33 FADE MUTING buttons (20)
- 34 VOLUME + / – buttons (20)







\* These buttons function while pressed with SHIFT.



## Playable Disc Types

This unit has been designed to play back the following discs:

- This unit can also play back MP3 files recorded on CD-Rs and CD-RWs. For in-depth information about MP3, see “MP3 Basic Operations” on page 32.
- We refer to DVD Video as DVD in this manual.

Disc Type	Mark (Logo)	Video Format*2	Region Code*1 Number
DVD VIDEO			3 or ALL
Video CD (VCD)		NTSC or PAL	—
Super Video CD (SVCD)			—
Audio CD		—	—
CD-R		—	—
CD-RW		—	—

In addition to the above discs, this unit can play back audio data recorded on CD Text, CD-G (CD Graphics), and CD-Extra.

- The following discs cannot be played back: DVD Audio, DVD-ROM, DVD-RAM, DVD-RW, DVD-R, CD-ROM, CD-I (CD-I Ready), Photo CD, etc. Playing back these discs will generate noise and damage the speakers.
- On some DVD, SVCD, or VCD, the actual operations may be different from what is explained in this manual, due to the programming and disc structure; such difference are not a malfunction of this unit.

- Continued use of irregular shape discs (heart-shape, octagonal, etc.) can damage the unit.



- The Macrovision's copy protection system is applied to this unit. If you make a copy from a disc recorded this copy protection signal on your VCR, the copy cannot be played back normally.

### \*1 Note on Region Code

DVD players and DVDs have their own Region Code numbers. This unit can play back only DVDs recorded with the NTSC or PAL color system whose Region Code numbers include “3.”



If a DVD with the improper Region Code numbers is loaded, “REGION CODE ERROR” appears on the display and playback cannot start.

### \*2 Note on Video Format

- DVDs recorded with the PAL color system cannot be converted into the NTSC color system.
- DVDs recorded with the NTSC color system can be converted into the PAL color system.
- When playing back a SVCD or VCD, the unit can convert both from PAL to NTSC and NTSC to PAL.

### Notes on CD-R and CD-RW

- User-edited CD-Rs (Recordable) and CD-RWs (Rewritable) can be played back only if they have been “finalized.”
- The unit can play back CD-Rs or CD-RWs if they have been recorded in the audio CD format. The unit can also play back CD-Rs or CD-RWs if MP3 files are recorded on them. However, these discs may not play back because of their disc characteristics, recording conditions, damage to the disc.
- Before playing back CD-Rs or CD-RWs, read their instructions or cautions carefully.
- CD-RWs may require a longer readout time, as the reflectance of CD-RWs is lower than for regular CDs.

This product incorporates copyright protection technology that is protected by method claims of certain U.S. patents and other intellectual property rights owned by Macrovision Corporation and other rights owners. Use of this copyright protection technology must be authorized by Macrovision Corporation, and is intended for home and other limited viewing uses only unless otherwise authorized by Macrovision Corporation. Reverse engineering or disassembly is prohibited.

## About audio formats

Some audio formats used on discs are described below:

- **Linear PCM**

Uncompressed digital audio, the same format used on CDs and most studio masters.

DVD supports 2-channels at sampling rates of 48/96 kHz and quantization of 16/20/24 bits.

Audio CD/Video CD is limited to 2-channels at 44.1 kHz at 16 bits.

- **Dolby Digital**

A surround audio format configured with up to six channels. Because the “LFE (Low-Frequency Effect for sub-woofer, etc.)” channel is an auxiliary channel, so this format is called “5.1-channel system.”

Not all Dolby Digital discs contain six (5.1) channel information.

- **DTS (Digital Theater Systems)**

A surround audio format configured with up to six (5.1) channel which is the same as Dolby Digital. Because the compression ratio is lower than for Dolby Digital, it provides wider dynamic range and better separation.

Not all DTS discs contain six (5.1) channel information.

- **MPEG Multichannel**

A surround audio format which can handle the augmentative 7.1-channel format (rare for home use), as well as 5.1-channel.

### IMPORTANT:

- This unit does not provide the DTS decoding function.

The sound signals of DTS are only output through the DVD OPTICAL DIGITAL OUT terminal and are not output through the speakers of this unit.

To listen to the sound of DTS, connect a DTS decoder or an amplifier compatible with DTS.

- To reproduce the multichannel sounds such as Dolby Digital 5.1 ch, DTS Digital Surround and MPEG Multichannel, connect an amplifier or a decoder compatible with these multichannel sources to this unit. (See page 11.)
- Playing back an Audio CD whose sound is encoded with DTS may generate noise and damage the speakers.  
When playing such a disc, turn the volume level on this unit to minimum.

## Disc structure

A DVD consists of “titles,” and each title may be divided into “chapters.” (See Example 1.)

For example, if a DVD disc contains some movies, each movie may have its own title number, and it may be further divided into chapters.

Example 1: DVD

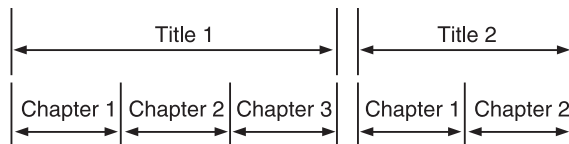

On the other hand, a SVCD, VCD, and Audio CD consist of “tracks.” (See Example 2.)

In general, each track has its own track number. (On some discs, each track may also be divided by Indexes.)

Example 2: SVCD/VCD/Audio CD

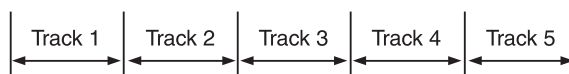

## Unpacking

After unpacking, check to be sure that you have all the following items.

The number in parentheses indicates the quantity of each piece supplied.

- FM antenna (1)
- AM loop antenna (1)
- Remote control (1)
- Batteries (2)
- Video cord (1)
- Speaker cords (2)

If any item is missing, consult your dealer immediately.

## Putting the Batteries into the Remote Control

Insert the batteries—R6P(SUM-3)/AA(15F)—into the remote control by matching the polarity (+ and -) on the batteries with the + and - marking on the battery compartment.

When the remote control can no longer operate the unit, replace both batteries at the same time.

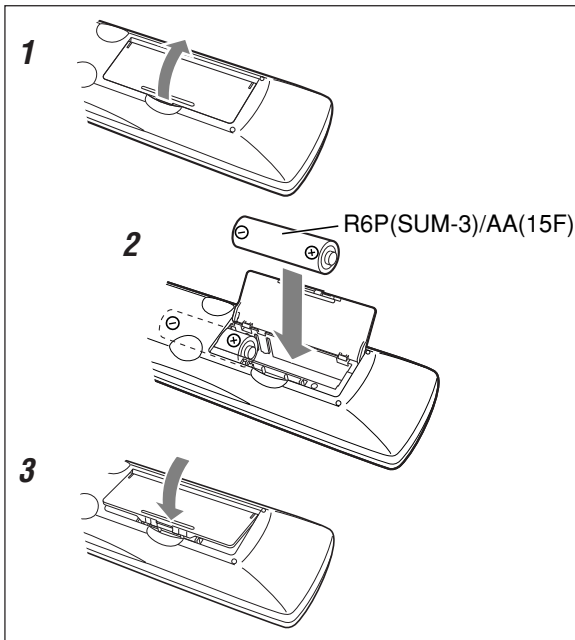

- DO NOT use an old battery together with a new one.
- DO NOT use different types of batteries together.
- DO NOT expose batteries to heat or flame.
- DO NOT leave the batteries in the battery compartment when you are not going to use the remote control for an extended period of time. Otherwise, the remote control will be damaged from battery leakage.

## Connecting Antennas

### FM antenna

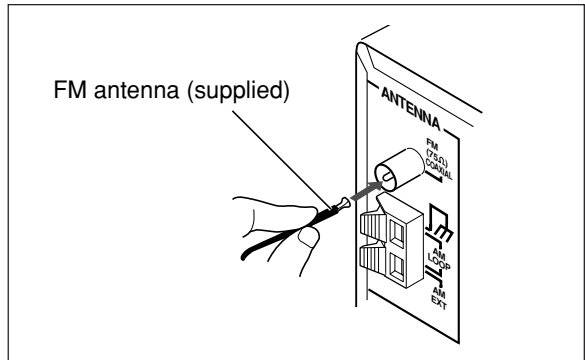

- 1 Attach the FM antenna to the FM (75 Ω) COAXIAL terminal.
- 2 Extend the FM antenna.
- 3 Fasten it up in the position which gives you the best reception.



#### About the supplied FM antenna

The FM antenna supplied with this unit can be used as temporary measure. If reception is poor, you can connect an outdoor FM antenna.

#### To connect an outdoor FM antenna

Before connecting it, disconnect the supplied FM antenna.

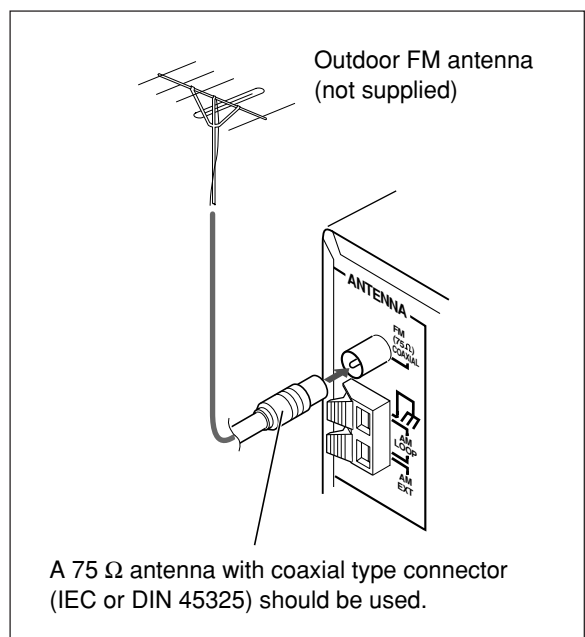

## AM antenna

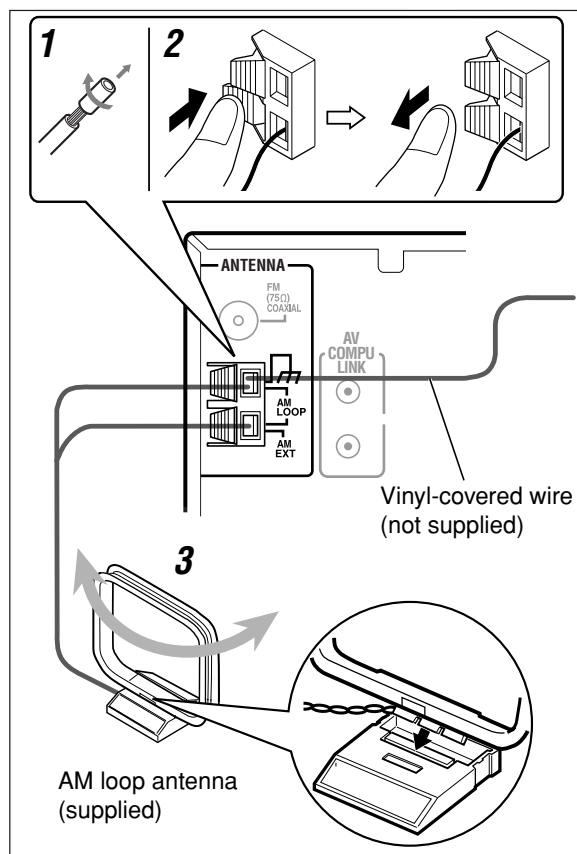

- 1 If the cords are covered with insulation, remove the short section of insulation at the end of each cord by twisting and pulling it off.
- 2 Connect the AM loop antenna to the AM LOOP terminals as illustrated.
- 3 Turn the AM loop antenna until you have the best reception.

### To connect an outdoor AM antenna

When reception is poor, connect a single vinyl-covered wire to the AM EXT terminal and extend it horizontally. The AM loop antenna must remain connected.



**For better reception of both FM and AM**

- Make sure the antenna conductors do not touch any other terminals or connecting cords.
- Keep the antennas away from metallic parts of the unit, connecting cords, and the AC power cord.

## Connecting Speakers

### To connect speakers

You can connect the speakers using the speaker cords.

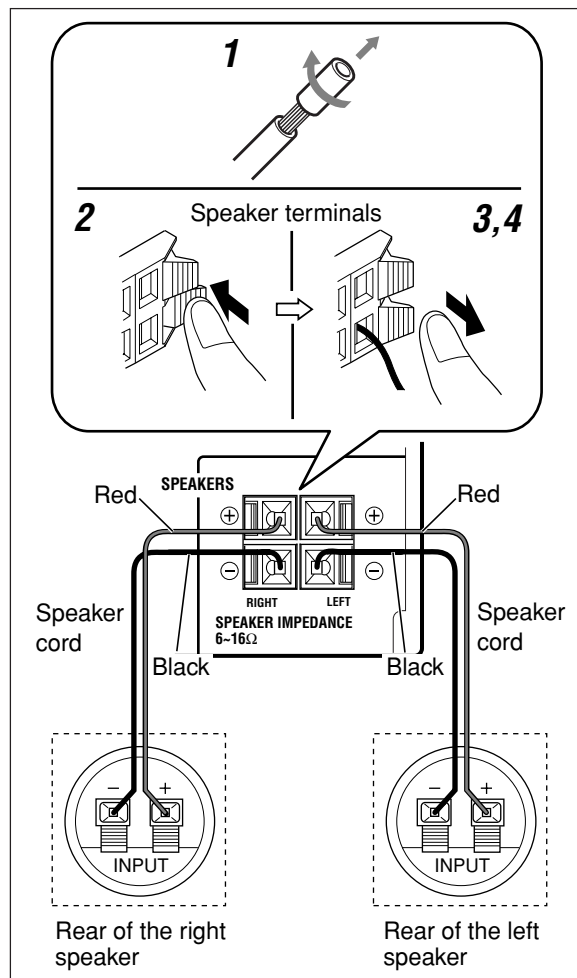

- 1 If the cords are covered with insulation, remove the short section of insulation at the end of each cord by twisting and pulling it off.
- 2 Hold the clamp of the speaker terminal.
- 3 Insert the end of the speaker cord into the terminal. Match the polarity of the speaker terminals: (+) to (+) and (-) to (-).
- 4 Release your finger from the clamp.

### IMPORTANT

- Use only speakers with the same speaker impedance as indicated by the speaker terminals on the rear of the unit.
- DO NOT connect more than one speaker to one speaker terminal.

## To remove the speaker grilles

The speaker grilles are removable as illustrated below:

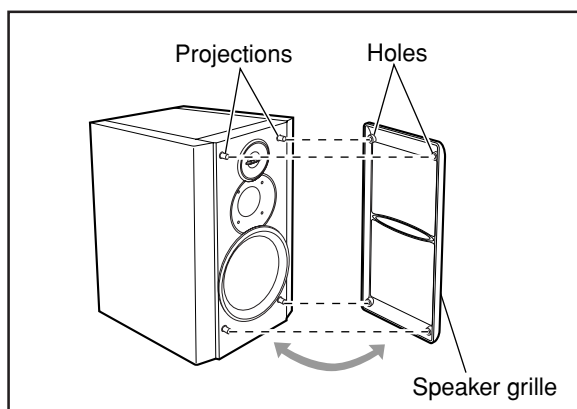

**To remove the speaker grille**, insert your fingers at the top of the speaker grille, then pull towards you. Also pull the bottom towards you.

**To attach the speaker grille**, put the projections of the speaker grille into the holes of the speaker.

### Caution on installation

This unit is compact but high powered, so it has a built-in cooling fan which operates when the internal heat rises due to continuous use and/or high volume level. If you want to place speakers or any equipment on the sides of the unit, leave a space of at least 1 cm between the main unit and each other unit to obtain sufficient cooling effect.

## Connecting a TV

Connect your TV and this unit using the composite video cord (supplied) or an S-video cord (not supplied).

- DVDs are protected by the copyguard system. Connecting to a TV through a VCR (or to a TV with a built-in VCR) may cause distortion of picture.
- You can also use JVC's AV COMPU LINK control system. (See page 93.)

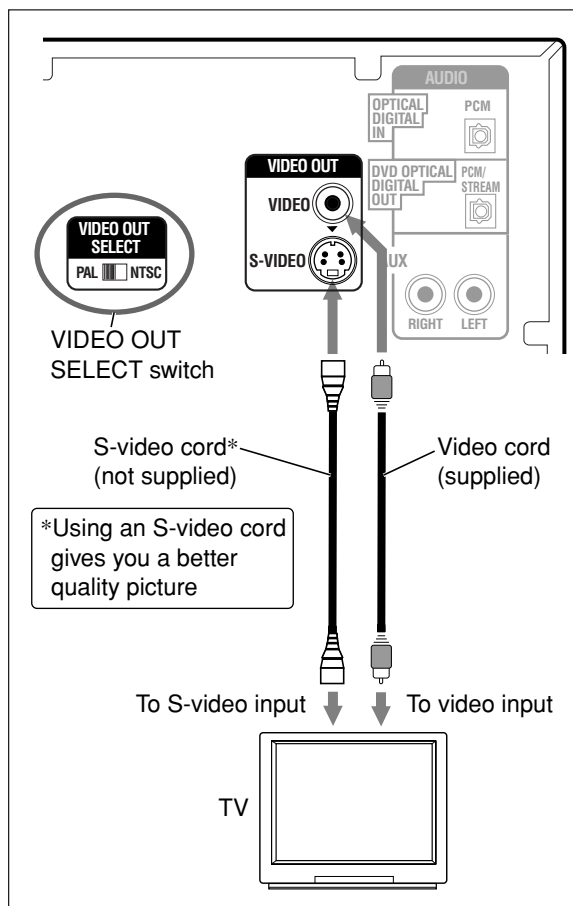

### To select the color system

This unit is compatible with the PAL and NTSC systems. Set the VIDEO OUT SELECT switch on the rear panel while in standby mode to match the color system of your TV. Make sure that the color system marked on the package of a DVD, SVCD, or VCD matches that of your TV.



**Before playing back a disc**, select the correct "MONITOR TYPE" in the DISPLAY menu according to the aspect ratio of your TV. See "To select the monitor type" on page 15.

## Connecting Other Equipment

You can connect other equipment such as a digital decoder to reproduce multichannel sounds or audio equipment which can be used as a playback device.

When you connect and use such equipment, refer also to its manual.



- DO NOT connect other equipment while the power is on.
- DO NOT plug in any equipment until all connections are complete.

### To connect audio equipment with an optical digital input terminal—such as a digital decoder

By using an optical digital cord (not supplied), you can connect audio equipment with an optical digital input terminal.

To reproduce multichannel sounds such as Dolby Digital 5.1 ch, DTS Digital Surround or MPEG Multichannel, connect a digital decoder or an amplifier with a built-in decoder .

- See “About sounds output through the DVD OPTICAL DIGITAL OUT terminal” on the right column.

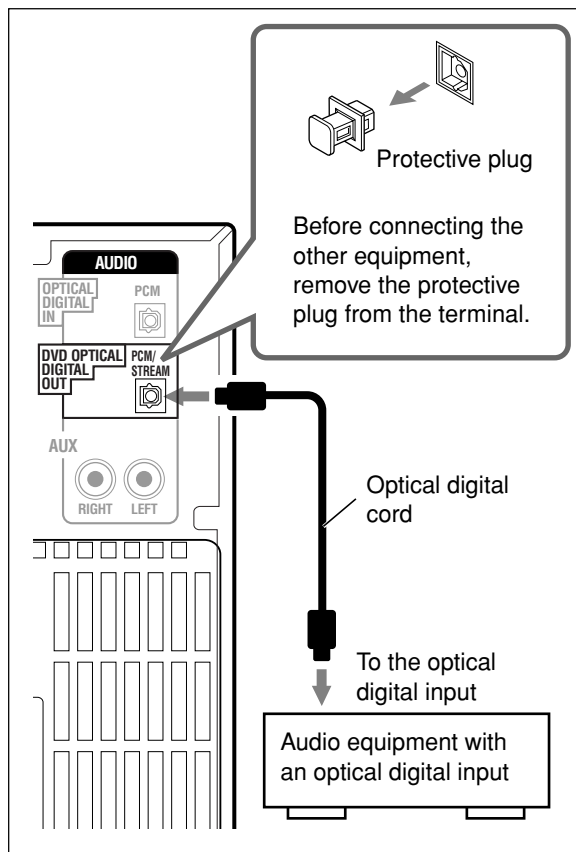

Before playing back a disc, select “DIGITAL AUDIO OUTPUT” in the AUDIO menu according to audio equipment connected to the DVD OPTICAL DIGITAL OUT terminal. See “To select the output signal type” on page 16.

### About sounds output through the DVD OPTICAL DIGITAL OUT terminal

Digital signals (Linear PCM, Dolby Digital\*, DTS\*\*, MPEG Multichannel) are output from the disc played back on the built-in DVD player.

To reproduce multichannel sounds such as Dolby Digital 5.1 ch, DTS Digital Surround and MPEG Multichannel, connect an amplifier or a decoder compatible with these multichannel sources to this terminal.

- Digital signals from an MD played back on the built-in MD player are not output through this terminal.

\* Manufactured under license from Dolby Laboratories. “Dolby” and the double-D symbol are trademarks of Dolby Laboratories. Confidential unpublished works. © 1992–1997 Dolby Laboratories. All rights reserved.

\*\* Manufactured under license from Digital Theater Systems, Inc. US Pat. No. 5,451,942 and other world-wide patents issued and pending. “DTS,” and “DTS Digital Surround” are trademarks of Digital Theater Systems, Inc. Copyright 1996, 2000 Digital Theater Systems, Inc. All Rights Reserved.

## To connect audio equipment with an optical digital output terminal

By using an optical digital cord (not supplied), you can connect audio equipment with an optical digital output terminal.

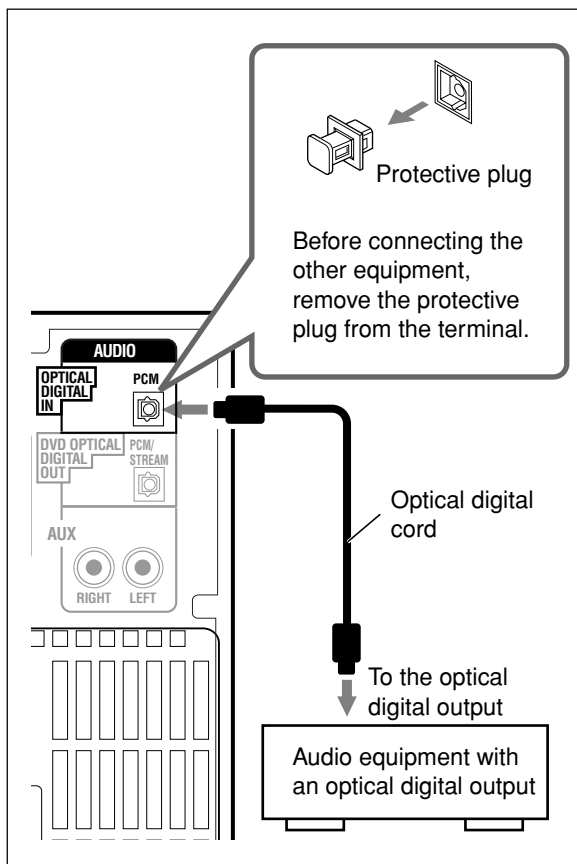

To listen to or to record the sound from audio equipment connected to the OPTICAL DIGITAL IN terminal, select "AUX-DIGITAL" as the source to play. (See page 20.)

- You can only play the sources recorded with Linear PCM through the OPTICAL DIGITAL IN terminal.



### When connecting audio equipment to the OPTICAL DIGITAL IN terminal

The above connection allows you to perform digital-to-digital recording on an MD. (See page 61.)



DO NOT play the sources recorded with other than Linear PCM, such as Dolby Digital or DTS, through the OPTICAL DIGITAL IN terminal. Playing such sources may cause noises from the speakers and may damage them.

## To connect analog audio equipment

By using an RCA pin plug cord (not supplied), you can connect analog audio equipment.

- Be sure that the plugs of the audio cords and the jacks on the rear of the unit are color-coded: White plugs and jacks are for left audio signals, and red ones for right audio signals.

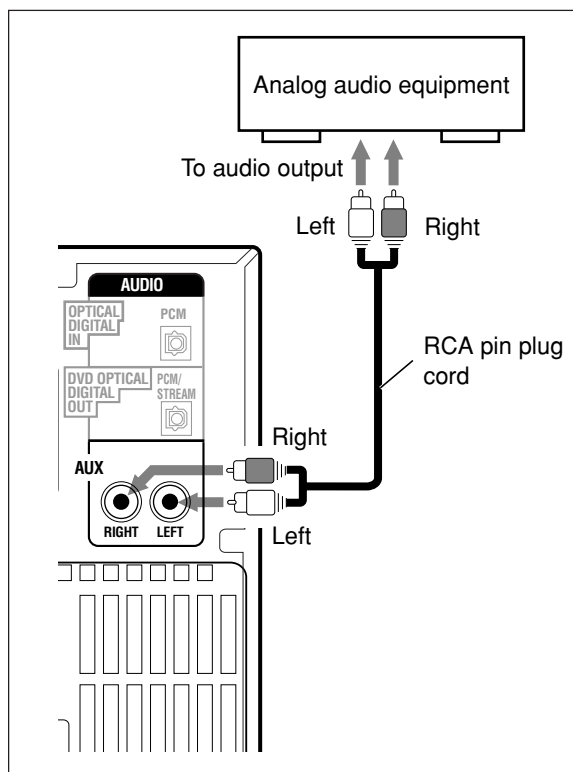

To listen to or to record the sound from analog audio equipment connected to the AUX jacks, select "AUX" as the source to play. (See page 20.)

NOW you are ready to plug in the unit and any other connected equipment.

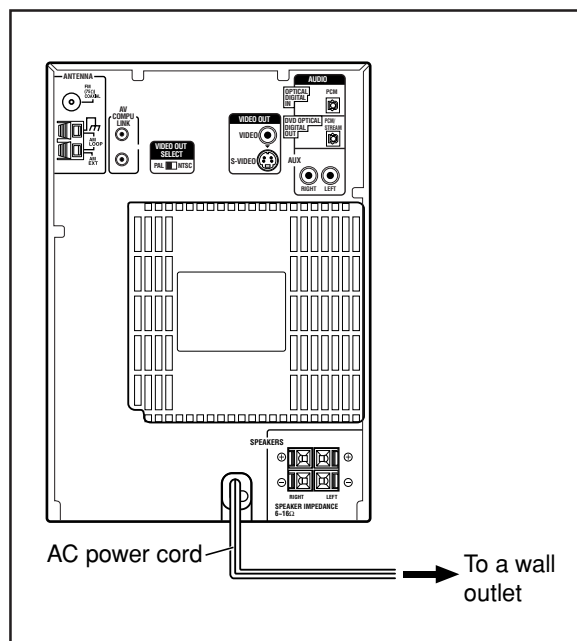

When you connect the AC power cord into a wall outlet, the unit automatically starts the display demonstration (Automatic display demonstration).

- Each time you press and hold COLOR/DEMO (or COLOR on the remote control) for more than 2 seconds, the Automatic display demonstration turns on (“DEMO ON” appears in the main display) and off (“DEMO OFF” appears in the main display).

**To stop and cancel the display demonstration manually,** press COLOR/DEMO (or COLOR on the remote control) during display demonstration while the unit is in standby mode.

- Pressing DIMMER (see page 22) or DISP/CHARA (see page 17) also cancels the display demonstration.
- “0:00” flashes in the main display until you set the built-in clock. After setting the clock, the clock time will appear in the main display while the unit is turned off. To set the built-in clock, see “Setting the Clock” on page 17.

**To start the display demonstration manually,** press COLOR/DEMO (or COLOR on the remote control) while the unit is in standby mode.

- Each time you press the button, the display demonstration alternates between on and off.

## Setting the DVD Player

You need to set the following, using the setting menu shown on the TV, before starting playback.

- You can select the language used in the setting menu.
- If an Audio CD or MP3 disc is loaded, you cannot show the setting menu. Before starting the setting, remove the disc.
- For further information about the setting menu, see pages 83 to 87.

**Step 1: Selecting the On-screen language for the setting menu**

**Step 2: Selecting the monitor type according to your TV**

If audio equipment is connected to the DVD OPTICAL DIGITAL OUT terminal:

**Step 3: Selecting the output signal type**

If audio equipment is NOT connected to the DVD OPTICAL DIGITAL OUT terminal:  
**Setting is finished.**

**Go to the next page to start the setting. ➡**



**If no operation is done for about five minutes while the setting menu appears on the TV**

The screen saver screen (see page 28) automatically appears on the TV instead of the setting menu to prevent the TV screen from being damaged.

To show the setting menu again, press CHOICE while holding down SHIFT.

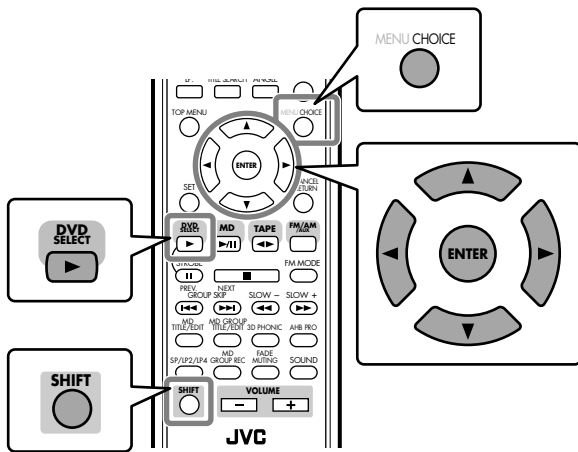

**On the remote control ONLY:****To select the On-screen language for the setting menu—Step 1:**

**1** Turn on the TV and select the correct input mode on the TV.

**2** Press DVD SELECT ►, then ■.

The unit turns on and the DVD player is selected as the source to play.

The opening screen appears on the TV.

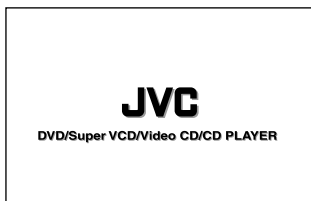

**3** Press CHOICE while holding down SHIFT.

The 语言 (LANGUAGE) menu appears on the TV.

- When you purchased this unit, the On-screen language used for the setting menu is set to Chinese (中国语).
- A selected item shows in green.

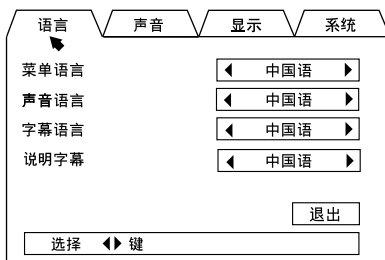

**4** Press Cursor ▼ repeatedly to move ◀ to “说明字幕” (ON SCREEN LANGUAGE).

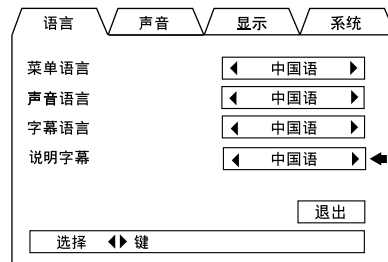

**5** Press Cursor ▶/◀ to select the language you want.

You can select the language from among ENGLISH, Chinese (中国语), and Spanish (ESPAÑOL).

The language for the setting menu changes to the one you select.

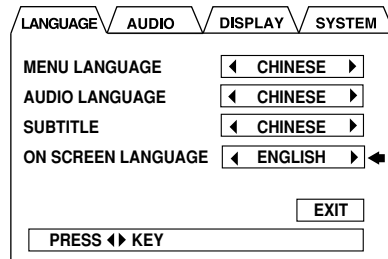

Ex.: “ENGLISH” is selected.

- The language in other indications shown on the TV while you operate the unit also changes to the one you select.

Go to “To select the monitor type” on the next page. ➡

## To select the monitor type—Step 2:

You need to select the monitor type to match your TV to play back DVDs recorded with a height/width ratio of 16:9.

- 1** Press Cursor **▲** repeatedly to move **▶** to “LANGUAGE.”

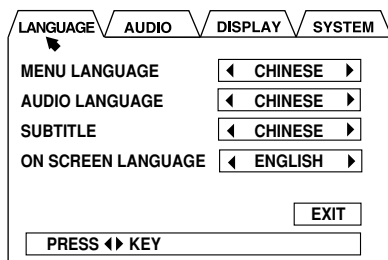

- 2** Press Cursor **▶/◀** repeatedly to move **▶** to “DISPLAY.”

DISPLAY menu appears on the TV.

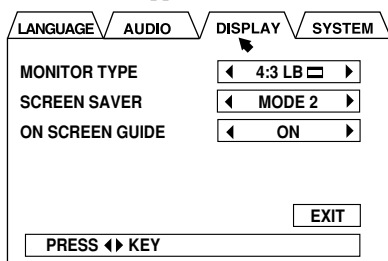

- 3** Press Cursor **▼** to move **◀** to “MONITOR TYPE.”

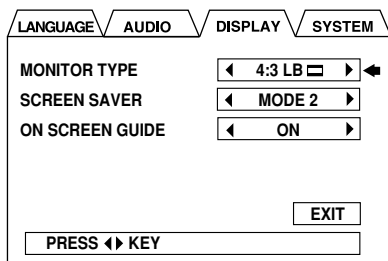

- 4** Press Cursor **▶/◀** to select the monitor type.

Select the monitor type according to the guidelines on the right column.

- If audio equipment is connected to the DVD OPTICAL DIGITAL OUT terminal:  
**Go to “To select the output signal type” on the next page. ▶▶**
- If audio equipment is NOT connected to the DVD OPTICAL DIGITAL OUT terminal:  
**The setting is done.**  
**Press CHOICE while holding down SHIFT.**  
The setting menu goes off.

## ■ Guidelines to select the monitor type

Selectable types: 4:3 LB , 16:9 WIDE, 4:3 PS

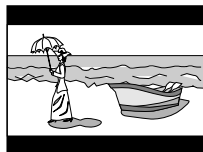

- 4:3 LB (Letter Box)** :  
Select when viewing on a TV whose aspect ratio is 4:3.  
While viewing a wide screen picture, the black bars appear on the top and the bottom of the screen.

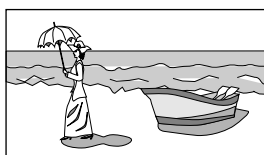

- 16:9 WIDE:**  
Select when viewing on a TV whose aspect ratio is 16:9.

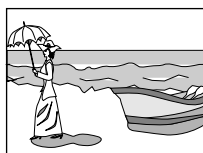

- 4:3 PS (Pan Scan)** :  
Select when viewing on a TV whose aspect ratio is 4:3.  
While viewing a wide screen picture, the black bars do not appear; however, a portion of the left and right edges of the picture will not show on the screen.

- Even if “4:3 PS ” is selected, the screen size may become “4:3 LB ” while playing some DVDs. This depends on how the DVD is programmed and recorded.
- If a disc (or some portions of the disc) is recorded with video signals of 4:3 aspect ratio, this setting does not take effect. The pictures are displayed with full 4:3 aspect ratio or with 4:3 Letter Box.

### To select the output signal type—Step 3:

If you connect audio equipment to the DVD OPTICAL DIGITAL OUT terminal, you need to select the type of digital signals output through the terminal according to the particular kind of audio equipment.

**1** Press Cursor **▲** to move **▶** to “DISPLAY.”

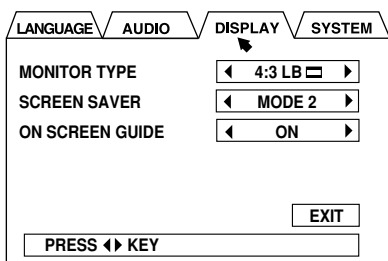

**2** Press Cursor **◀** to move **▶** to “AUDIO.”  
AUDIO menu appears on the TV.

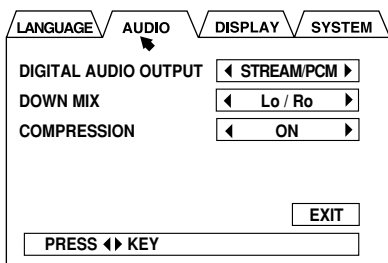

**3** Press Cursor **▼** to move **◀** to “DIGITAL AUDIO OUTPUT.”

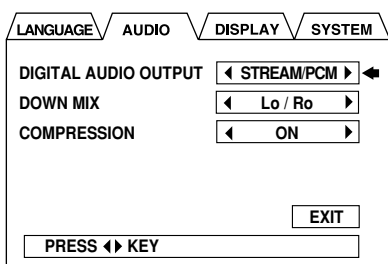

**4** Press Cursor **▶/◀** to select the output signal type.

Select the output signal type according to the guidelines on the right column.

**To exit from the setting menu**, press CHOICE while holding down SHIFT.

The setting menu goes off.

- You can also exit from the setting menu by pressing Cursor **▲/▼** to select EXIT in the menu, then press ENTER.

### ■ Guidelines to select the output signal type

Selectable types: STREAM/PCM, PCM ONLY, DOLBY DIGITAL/PCM

#### • STREAM/PCM:

Select when connecting an amplifier or a decoder compatible with DTS, Dolby Digital and MPEG Multichannel.

#### • PCM ONLY:

Select when connecting an amplifier compatible only with Linear PCM or a digital recording device such as an MD recorder, DAT deck, etc.

#### • DOLBY DIGITAL/PCM:

Select when connecting an amplifier or a decoder compatible only with Dolby Digital.

### Output Signals Through the DVD OPTICAL DIGITAL OUT Terminal

Playback disc	Output signals		
	STREAM/PCM	PCM ONLY	DOLBY DIGITAL/PCM
DVD with 48 kHz, 16 bit Linear PCM	48 kHz, 16 bit Linear PCM	◀	◀
DVD with 48 kHz, 20/24 bit Linear PCM	48 kHz, 20/24 bit Linear PCM	◀	◀
DVD with 96 kHz, Linear PCM	No output	◀	◀
DVD with Dolby Digital	Dolby Digital bitstream	48 kHz, 16 bit Linear PCM	Dolby Digital bitstream
DVD with DTS	DTS bitstream	No output	◀
DVD with MPEG Multichannel	MPEG bitstream	48 kHz, 16 bit Linear PCM	◀
SVCD/VCD/Audio CD	44.1 kHz, 16 bit Linear PCM	◀	◀
Audio CD with DTS Digital Surround	DTS bitstream	◀	◀
MP3 disc	No output	◀	◀



**When “PCM ONLY” or “DOLBY DIGITAL/PCM” is selected as the output signal type**

The sound signals of DTS are not output from the DVD OPTICAL DIGITAL OUT terminal.

To listen to the sound of DTS on audio equipment connected to the terminal, select “STREAM/PCM” as the output signal type.



**When “PCM ONLY” is selected as the output signal type**

Also set “DOWN MIX” in the AUDIO menu. (See page 85.)

## Setting the Clock

You can set the clock when the unit is either turned on or in standby mode.

### On the remote control ONLY:

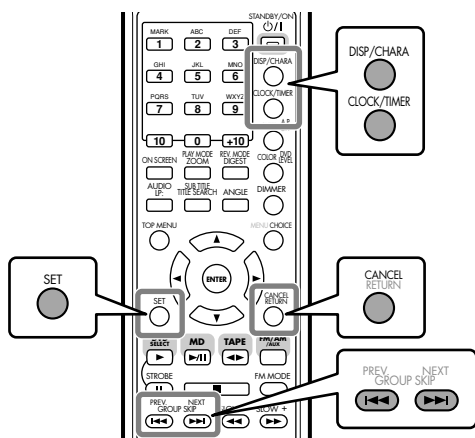

### 1 Press CLOCK/TIMER.

“0:00” appears in the main display with the hour digit flashing.



### 2 Press ►► or ◄◄ repeatedly to adjust the hour.

- When you press and hold the button, the hour digit changes continuously.
- You can also use the number buttons.
  - To adjust the hour to 5, press 5.
  - To adjust the hour to 12, press +10, then 2.
  - To adjust the hour to 20, press +10, then 10 (or press +10 twice, then 0).

### 3 Press SET to set the hour.

The minute digit starts flashing.

- If you want to change the hour again, press CANCEL.
- The hour digit starts flashing again.

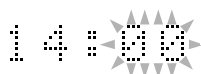

### 4 Press ►► or ◄◄ repeatedly to adjust the minute.

- When you press and hold the button, the minute digit changes continuously.
- You can also use the number buttons.
  - To adjust the minute to 5, press 5.
  - To adjust the minute to 25, press +10, +10, then 5.
  - To adjust the minute to 30, press +10, +10, then 10 (or press +10 three times, then 0).

### 5 Press SET to finish setting the clock.

The built-in clock starts.



#### To adjust the clock again

Once you have adjusted the clock, you need to press CLOCK/TIMER repeatedly until the clock setting screen appears in the main display (the hour digit starts flashing).



#### When you unplug the AC power cord or if a power failure occurs

The clock loses its setting and resets to “0:00.” If this happens, set the clock again.

### To turn off the clock indication (power save mode)

#### On the remote control ONLY:

Press DISP/CHARA while the unit is in standby mode. “DISPLAY OFF” appears in the main display and the clock indication goes off.

To turn on the clock indication, press DISP/CHARA again while the unit is in standby mode.

“DISPLAY ON” appears in the main display.

### To show the clock when the unit is turned on

#### On the remote control ONLY:

Press DISP/CHARA repeatedly until the clock indication appears in the main display.

- If an MD is inserted, the MD remaining recording time (“REC REMAIN”) is shown before the clock indication.

# Basic and Common Operations

The buttons emphasized in the illustration below are used and explained in the following section (pages 19 to 23).

## Remote control

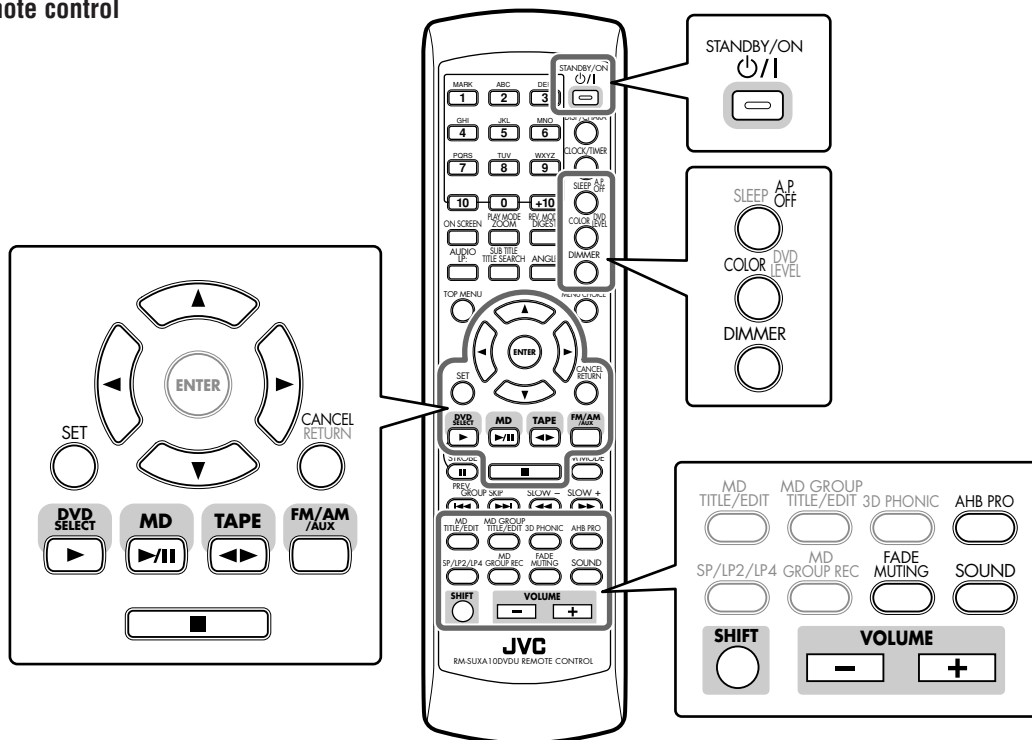

## Main unit

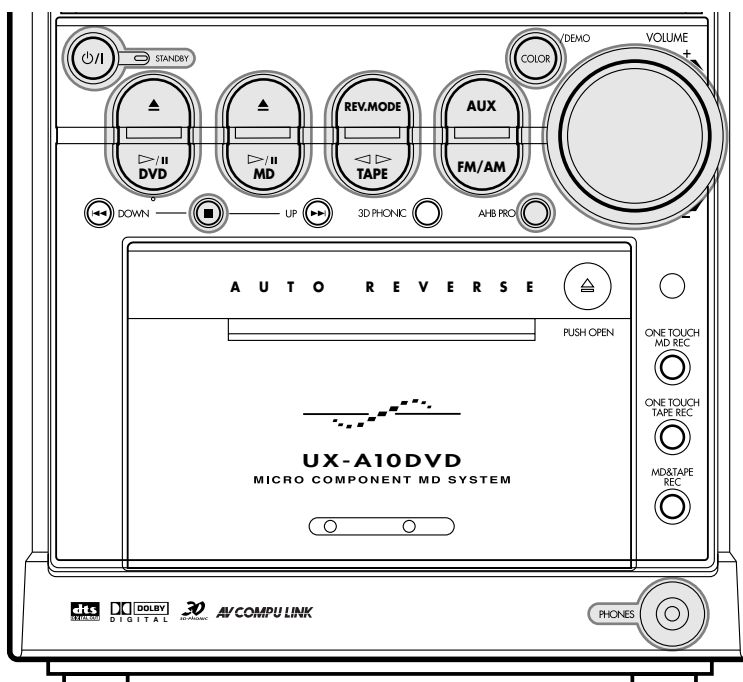

## Turning On the Power

When you press one of the source selecting buttons, the unit automatically turns on (and starts playback if the source is ready).

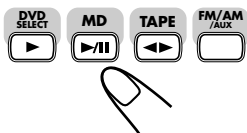

### On the remote control:







### On the main unit



\* Pressing DVD ▲ or MD ▲ also turns on the unit.

**To turn on the unit without playing,** press STANDBY/ON  (or  on the main unit). The STANDBY lamp on the main unit goes off. "HELLO" appears in the main display.

**To turn off the unit (on standby),** press STANDBY/ON  (or  on the main unit) again. The STANDBY lamp on the main unit lights up. "SEE YOU" appears in the main display.

- When you use the Resume function (see page 86), turning off the power while playing a disc stops playback and stores the stop point. By pressing DVD SELECT  (or DVD  on the main unit), you can turn on the unit and start playback again from the position where you have stopped—Resume play. ("RESUME" appears in the main display.)
- A little power is always consumed even while the unit is in standby mode.

**To switch off the power supply completely,** unplug the AC power cord from the AC outlet.



**When you unplug the AC power cord or if a power failure occurs**

The settings you have done will be erased.

### To turn off the unit automatically (Auto Power Off)

Using the Auto Power Off function, the unit automatically turns itself off if no sound comes in for more than 3 minutes except when FM or AM is selected as the source. If an operation is done during this 3-minute period, Auto Power Off is canceled temporarily even though no sound comes in.

- You can also turn off the unit automatically by using the sleep timer. (See page 92.)

### On the remote control ONLY:

**To activate Auto Power Off,** press A.P.OFF while holding down SHIFT.

The A.P.off (Auto Power off) indicator lights up on the display.

- When no sound comes in, the A.P.off indicator starts flashing on the display. About 20 seconds before the unit turns itself off, "AUTO POWER OFF" starts flashing in the main display.

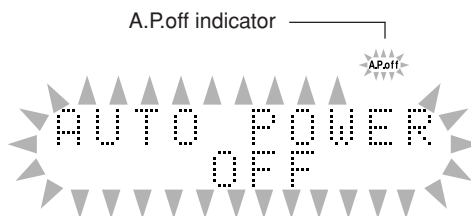

**To deactivate Auto Power Off,** press A.P.OFF while holding down SHIFT.

The A.P.off indicator goes off.

## Selecting the Sources and Starting Play

To select the tuner or external equipment as the source

### On the remote control:

Press FM/AM/AUX.

The unit automatically turns on (when the unit is in standby), and the last selected source appears in the main display.

- Each time you press the button, the source changes as follows:



### On the main unit:

- Press FM/AM to select the tuner.  
Each time you press the button, the band alternates between FM and AM.
- Press AUX to select external equipment.  
Each time you press the button, the source alternates between “AUX” and “AUX-DIGITAL.”  
–Select “AUX” to listen to the sound from external equipment connected to the AUX jacks.  
–Select “AUX-DIGITAL” to listen to the sound from external equipment connected to the OPTICAL DIGITAL IN terminal.

- For more detailed tuner operations, see pages 24 to 26.
- For operating external equipment, see its manual also.

To select the DVD player as the source, press DVD SELECT ► (or DVD ▷/■ on the main unit).

The unit automatically turns on (when the unit is in standby), and “READING” appears in the main display for a while.

- Play will start if a disc is in the disc tray.
- “NO DISC” will appear in the main display if a disc is not loaded.

To stop playback, press ■.

- For more detailed operations, see pages 27 to 39, 49 to 55.

To select the MD player as the source, press MD ►/■.

The unit automatically turns on (when the unit is in standby), and “MD READING” appears in the main display for a while.

- Play will start if an MD is in the MD loading slot.
- “MD NO DISC” will appear in the main display if an MD is not loaded.

To stop playback, press ■.

- For more detailed operations, see pages 40 to 46.

To select the tape as the source, press TAPE ◀▶.

The unit automatically turns on (when the unit is in standby), and “TAPE” appears in the main display.

- Play will start if a tape is in the cassette holder.
- To stop playback, press ■.

- For more detailed operations, see pages 47 and 48.



When changing from another source to “AUX” or “AUX-DIGITAL”

If the sound from the component connected to the AUX jacks or the OPTICAL DIGITAL IN terminal is too loud or is not loud enough (without changing the volume level), you can change the audio input level through the AUX jacks or the OPTICAL DIGITAL IN terminal. (See page 23.)

## Adjusting the Volume

You can adjust the volume level only while the unit is turned on.

- The volume level has no effect on recording.

### On the remote control:

To increase the volume, press VOLUME +.

To decrease the volume, press VOLUME –.

- When you press and hold each button, you can change the volume level continuously.

### On the main unit:

To increase the volume, turn VOLUME + / – control clockwise.

To decrease the volume, turn VOLUME + / – control counterclockwise.

VOLUME 21

- You can adjust the volume level within the range of 0 (silent) to 40 (maximum).



### For private listening

Connect a pair of headphones to the PHONES jack. No sound comes out of the speakers. Be sure to turn down the volume before connecting or putting on the headphones.



DO NOT turn off (on standby) the unit with the volume set to an extremely high level; Otherwise, the sudden blast of sound can damage your hearing, speakers and/or headphones when you turn on the unit or start playing any source. REMEMBER you cannot adjust the volume level while the unit is in standby mode.

## To turn down the volume level temporarily

### On the remote control ONLY:

Press FADE MUTING.

The volume level gradually decreases to “VOLUME 0.”

To restore the sound, press FADE MUTING again.

- Turning VOLUME + / – control clockwise (to +) on the unit or pressing VOLUME + on the remote control also restores the sound.

## Reinforcing the Bass Sound

The richness and fullness of the bass sound is clearly maintained regardless of how low you set the volume —Active Hyper Bass Pro.

- This function also affects the sound from headphones.
- This function affect neither recording nor the signals output through the DVD OPTICAL DIGITAL OUT terminal.

**To get the effect**, press AHB PRO repeatedly so that “AHB PRO 1” or “AHB PRO 2” appears in the main display. The AHBPRO indicator also lights up on the display.

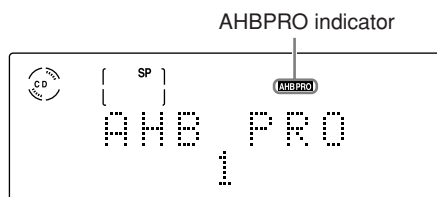

Ex.: When you select “AHB PRO 1.”

- Each time you press the button, the Active Hyper Bass Pro mode changes as follows:

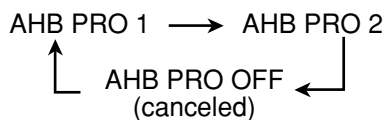

- “AHB PRO 2” is more effective than “AHB PRO 1.”

**To cancel the effect**, press AHB PRO repeatedly until “AHB PRO OFF” appears in the main display. The AHBPRO indicator goes off.

## Selecting the Sound Modes

You can select one of four preset sound modes.

- This function also affects the sound from headphones.
- This function affect neither recording nor the signals output through the DVD OPTICAL DIGITAL OUT terminal.

### On the remote control ONLY:

**To select the sound modes**, press SOUND repeatedly until the sound mode you want appears in the main display. The SOUND indicator also lights up on the display.

- Each time you press the button, the sound mode changes as follows:

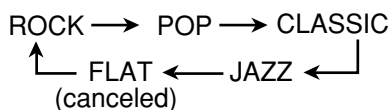

- ROCK:** Boosts low and high frequency. Good for acoustic music.
- POP:** Good for vocal music or voice.
- CLASSIC:** Good for classical music.
- JAZZ:** Good for jazz music.
- FLAT:** Cancels the sound mode.

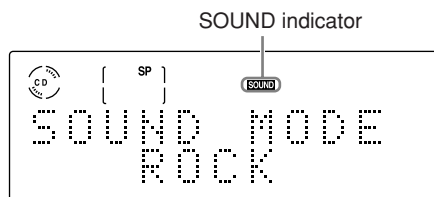

Ex.: When you select “ROCK.”

**To check the sound mode currently selected**, press SOUND.

The currently selected sound mode will appear in the main display.

**To cancel the sound modes**, press SOUND repeatedly until “FLAT” appears in the main display.

The SOUND indicator goes off.



## Changing the Display Illumination

You can change the illumination color and brightness of the electronic swing panel and the display window.

### To select the illumination color

You can set the illumination color to your preference.

Press **COLOR** (or **COLOR/DEMO** on the main unit) repeatedly while the unit is turned on until the color you want appears in the main display.

- Each time you press the button, the illumination color changes as follows:

<b>RAINBOW:</b>	The rainbow colors illuminate the electronic swing panel and the display.
↓	
<b>GRADATION:</b>	The illumination color changes gradually.
↓	
<b>WATER:</b>	A blue-based illumination pattern.
↓	
<b>FANTASY:</b>	Pastel colors illuminate the electronic swing panel and the display.
↓	
<b>CANDLE:</b>	A red-based illumination pattern.
↓	
<b>FOREST:</b>	A green-based illumination pattern.
↓	
<b>SNOW:</b>	A white-based illumination pattern.
↓	
<b>SKY:</b>	A sky-color based illumination pattern. The color changes according to the time if the built-in clock is set. If not, "ADJUST! CLOCK" flashes in the main display when you select this illumination color.
↓	
<b>MANUAL1:</b>	You can set the illumination color as you like (see the right column).
↓	
<b>MANUAL2:</b>	
↓	
(back to the beginning)	



### More on the illumination color

- The illumination colors cannot always be reproduced precisely. Due to the circumstances (room temperature, etc.) where the unit is used or the setting of DIMMER, colors may vary slightly.
- When you change the illumination color, the display may seem to move back and forth; this is a characteristic of this unit and is not a malfunction.
- When a strong light strikes the unit, it may become dark, but this is not a malfunction.
- While using the unit, the electronic swing panel becomes warm, but this is not a malfunction.

### To create your favorite colors

You can create two favorite colors and store them in memory as "MANUAL1" and "MANUAL2."

- There is a time limit in doing the following steps. If the unit exits from the color adjusting mode before you finish, start from step 1 again.

#### On the remote control ONLY:

- Press **COLOR** repeatedly until "MANUAL1" or "MANUAL2" appears in the main display.  
The brightness level to be adjusted starts flashing.

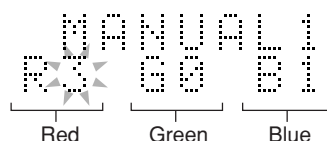

- To adjust the brightness of each color
  - Press **Cursor** ▶/◀ to select one of the fundamental colors (Red, Green, Blue) you want to adjust.
  - Press **Cursor** ▲/▼ repeatedly to adjust the level of the brightness (within the range of 0 to 3).
    - As you increase the number, the color becomes brighter.
    - To restore the initial color for "MANUAL1" or "MANUAL2," press **CANCEL**.
  - Repeat steps 1) and 2) to create your favorite color.
  - Press **SET**.  
Your favorite color is stored.



If you do not make any adjustment for about 8 seconds

The normal display resumes and the color you have created up to that time is stored.

### To change the display brightness

#### On the remote control ONLY:

Press **DIMMER** while the unit is turned on.

- Each time you press the button, the display brightness changes as follows:

<b>DIMMER1:</b>	The display illumination dims.
↓	
<b>DIMMER2:</b>	The illumination color disappears.
↓	
<b>DIMMER OFF:</b>	The display illumination resumes.
• Pressing <b>COLOR</b> (or <b>COLOR/DEMO</b> on the main unit) also resumes the display brightness.	
↓	
(back to the beginning)	

## Adjusting the Audio Input Level

If the sound from the component connected to this unit is too loud or is not loud enough when changing from another source to “AUX” or “AUX-DIGITAL” (without changing the volume level), you can change the audio input level through the AUX jacks or the OPTICAL DIGITAL IN terminal.

### ■ Adjusting the audio input level through the AUX jacks

**1** Press FM/AM/AUX (or AUX on the main unit) repeatedly so that “AUX” appears in the main display.

#### On the remote control:

- Each time you press the button, the source changes as follows:



#### On the main unit:

- Each time you press the button, the source alternates between “AUX” and “AUX-DIGITAL.”

**2** Press and hold SET on the remote control for more than 2 seconds.

- Each time you press and hold the button, the audio input level alternates between “LEVEL 1” and “LEVEL 2.”

**LEVEL 1:** Select when the sound is too loud (initial setting).

**LEVEL 2:** Select when the sound is not loud enough.

AUX  
LEVEL 1



**notes** If you change the audio input level through the AUX jacks

The recording level through the AUX jacks also changes. Selecting “LEVEL 2” rather than “LEVEL 1” makes the sound recorded louder.

### ■ Adjusting the audio input level through the OPTICAL DIGITAL IN terminal

**1** Press FM/AM/AUX (or AUX on the main unit) repeatedly so that “AUX-DIGITAL” appears in the main display.

#### On the remote control:

- Each time you press the button, the source changes as follows:



#### On the main unit:

- Each time you press the button, the source alternates between “AUX” and “AUX-DIGITAL.”

**2** Press and hold SET on the remote control for more than 2 seconds.

REC LEVEL  
0 dB

**3** Press Cursor ▲/▼ to adjust the audio input level.

You can adjust the audio input level through the OPTICAL DIGITAL IN terminal within the range from “-12 dB” to “12 dB” by 2 dB step. (“0 dB” is the initial setting.)

- To increase the audio input level, press Cursor ▲.
- To decrease the audio input level, press Cursor ▼.



**notes** If you change the audio input level through the OPTICAL DIGITAL IN terminal

The recording level through the OPTICAL DIGITAL IN terminal also changes according to the change of the audio input level.

## Prohibiting Disc Ejection

You can prohibit disc and MD ejection from the unit and can lock discs—Disc Lock.

#### On the main unit ONLY:

**To prohibit disc ejection**, press and hold ■, then press REV. MODE when the unit is in standby mode. “LOCKED” appears in the main display for a while, and the loaded disc and MD are locked.

LOCKED

If you try to eject the locked discs “LOCKED” appears to inform you that the Disc Lock is in use.

**To cancel the prohibition and unlock the discs**, repeat the above procedure.

“UNLOCKED” appears in the main display for a while, and the loaded disc and MD are unlocked.

# Listening to FM and AM Broadcasts

The buttons emphasized in the illustration below are used and explained in the following section (pages 25 and 26).

## Remote control

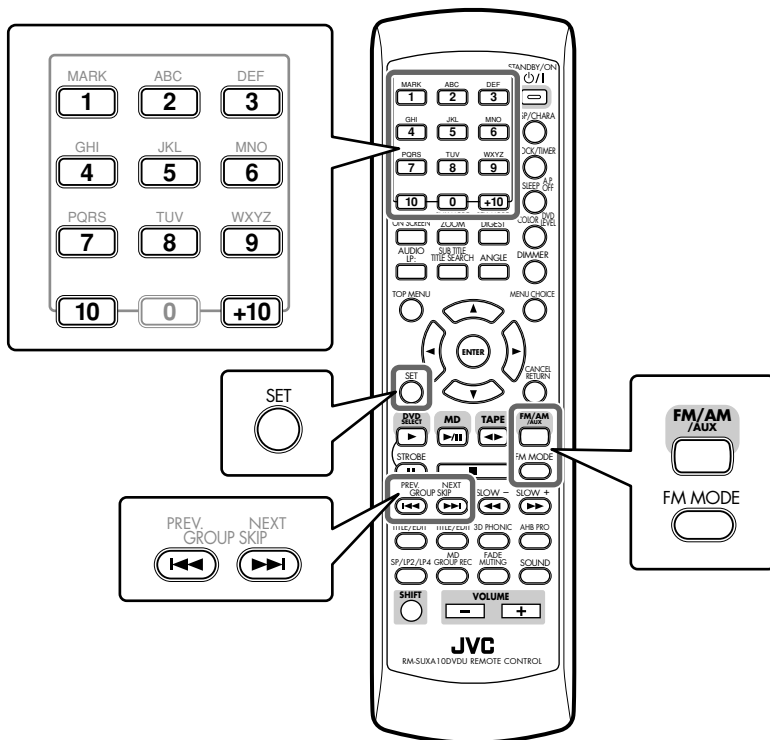

## Main unit

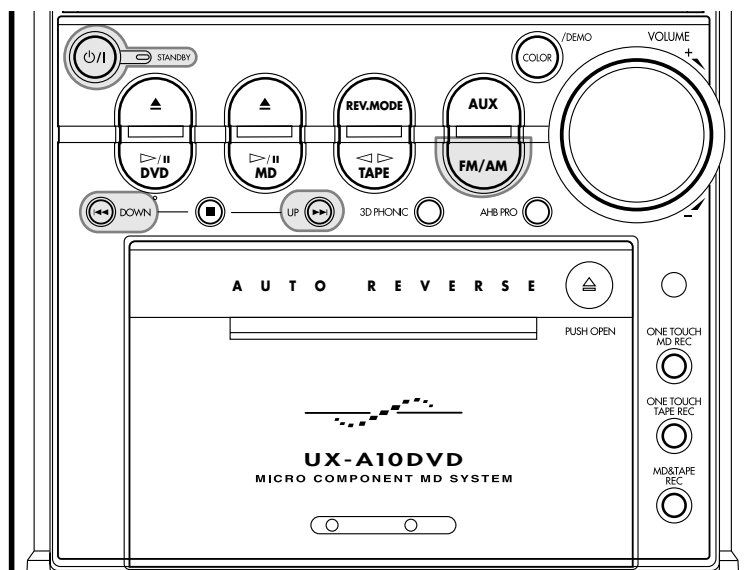

## Setting the AM Tuner Interval Spacing

Some countries space AM stations 9 kHz apart, and some countries use 10 kHz spacing.

When shipped, the built-in AM tuner is set to 9 kHz spacing. You can change it to 9 kHz or 10 kHz spacing.

### **On the main unit ONLY:**

**To set the AM tuner to the 10 kHz spacing**, be sure that the unit is turned off, but is plugged into a wall outlet.

While holding ►►, press ⏻/|. The unit turns on and tunes in to 530 kHz.

**To set it back to the 9 kHz spacing**, be sure that the unit is turned off, but is plugged into a wall outlet.

While holding ◀◀, press ⏻/|. The unit turns on and tunes in to 531 kHz.



**When you change the AM tuner interval spacing**

The preset stations you have set (both FM and AM) will be erased. In this case, preset stations again. See “Presetting Stations” on the next page.

## Tuning in to a Station

### **1 Press FM/AM/AUX (or FM/AM on the main unit) to select either “FM” or “AM.”**

When you press the button for the first time, the unit automatically turns on with the last selected source.

#### **On the remote control:**

- Each time you press the button, the source changes as follows:



#### **On the main unit:**

- Each time you press the button, the band alternates between FM and AM.

### **2 Press and hold ►► or ◀◀ (or UP or DOWN on the main unit) until the station frequencies start changing continuously in the main display.**

- ►► (UP): Increases the frequencies.
- ◀◀ (DOWN): Decreases the frequencies.

The unit starts searching for stations and stops when a station of sufficient signal strength is tuned in.

- If an FM program is broadcast in stereo, the STEREO indicator lights up on the display.

To stop during searching, press ►► or ◀◀ (or UP or DOWN on the main unit).



**When you repeatedly press ►► or ◀◀ (or UP or DOWN on the main unit)**

The frequency changes step by step.

### **To change the FM reception mode**

When an FM stereo broadcast is noisy or hard to receive, you can change the FM reception mode to improve the reception.

#### **On the remote control ONLY:**

##### **Press FM MODE.**

- Each time you press the button, FM reception mode alternates between STEREO and MONO.

**STEREO:** Normally select this.

You can hear stereo sound when a program is broadcast in stereo. The STEREO indicator lights while receiving the FM stereo broadcast (only when the reception is good).

**MONO:** Select this when an FM stereo broadcast is noisy or hard to receive. Reception improves though stereo effect is lost. The MONO indicator lights up on the display.

## Presetting Stations

You can preset 30 FM and 15 AM stations manually.

In some cases, test frequencies have been already stored for the tuner since the factory examined the tuner preset function before shipment. This is not a malfunction. You can preset the stations you want into memory by following the presetting method.

- There is a time limit in doing the following steps. If the setting is canceled before you finish, start from step **2** again.

### On the remote control ONLY:

**1** Tune in to the station (either FM or AM) you want to preset.

- See “Tuning in to a Station” on the previous page.

**2** Press SET.

The preset number starts flashing as follows:

FM 87.50 MHz

Ex.: When you select an FM station in step **1**.

- The unit always starts from the preset number 1.

**3** Press the number buttons to select a preset number.

Ex.: For preset number 5, press 5.

For preset number 15, press +10, then 5.

For preset number 20, press +10, then 10.

For preset number 30, press +10, +10, then 10.

- You can also select the preset number by pressing **▶▶** or **◀◀**.

**4** Press SET again.

“STORED” appears in the main display for a while.

STORED

The tuned station in step **1** is stored in the preset number selected in step **3**.

- Storing a new station on an already assigned number erases the previously stored one.



**When you unplug the AC power cord or if a power failure occurs**

The FM and AM preset stations will be erased in a day. If this happens, preset the stations again.

## Tuning in to a Preset Station

### On the remote control ONLY:

**1** Press FM/AM/AUX to select either “FM” or “AM.”  
When you press the button for the first time, the unit automatically turns on with the last selected source.

- Each time you press the button, the source changes as follows:

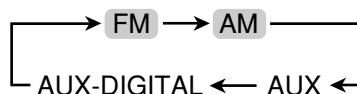

**2** Press the number buttons to select a preset number.

Ex.: For preset number 5, press 5.





For preset number 15, press +10, then 5.

For preset number 20, press +10, then 10.

For preset number 30, press +10, +10, then 10.

# Playing Back Discs

The buttons emphasized in the illustration below are used and explained in the following section (pages 28 to 39).

     shows the types of discs the operation is available for.

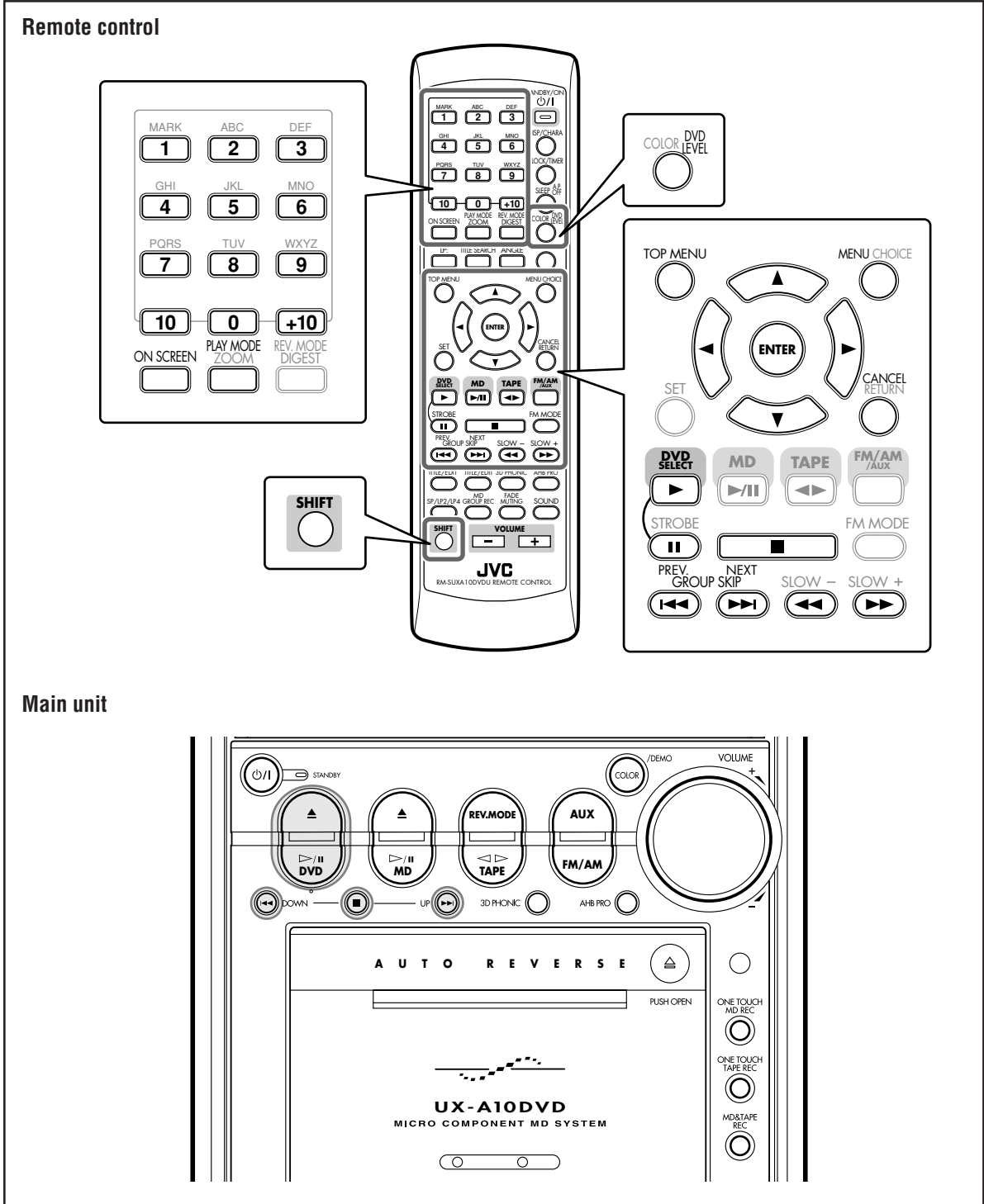

**IMPORTANT:**

Before performing any operations for DVD, SVCD and VCD, make sure of the following.





- Check the connection with the TV.
- Turn on the TV and select the correct input on the TV to view the pictures or on-screen menus/indications on the TV screen.
- Select the correct color system.

**To prevent screen burn-out with the screen saver**

A TV screen may be burned out if a static picture is displayed for a long time. To prevent this, the unit automatically dims the screen if a static picture is displayed for over 5 minutes (the screen saver function).

- Pressing any button will cancel the screen saver function.
- You can select the screen saver mode. (See page 86.)
- The screen saver does not work for Audio CDs and MP3 discs.

**On-screen guide icons**

- During DVD playback, the following guide icons may appear for a while on the TV screen:
  - “”: appears at the beginning of a scene containing multi-angle views.
  - “”: appears at the beginning of a scene containing multi-audio languages.
  - “”: appears at the beginning of a scene containing multi-subtitle languages.
- “▶” (Play), “||” (Pause), “▶▶”/“◀◀” (Fast forward/backward), “|▶”/“◀|” (Slow-motion forward/backward): appears when you perform each operation.
- If “” appears on the TV screen when pressing a button, the disc cannot accept an operation you have tried to do, or information required for that operation is not recorded on the disc.

**More about the on-screen guide icons**

- In some cases, without showing “,” operations will not be accepted.
- If you do not want the on-screen guide icons to appear, see page 86.

**Loading a Disc**

Available for:  DVD  SVCD  VCD  Audio CD  MP3

**1 Press DVD  on the main unit.**

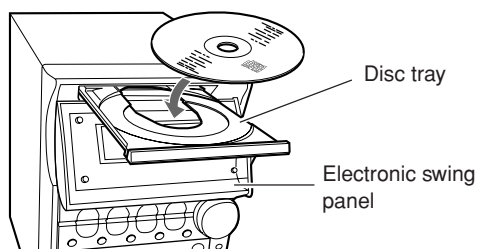
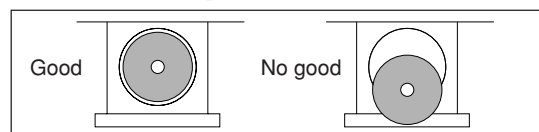

The unit automatically turns on, the electronic swing panel slides downward, then the disc tray comes out.

**2 Place a disc correctly on the circle of the disc tray with its label side up.**



- When using an 8 cm disc, place it on the inner circle of the disc tray.

**3 Press DVD  on the main unit.**

The disc tray closes, then the electronic swing panel slides upward automatically.

- If you press DVD  on the main unit (or DVD SELECT  on the remote control) instead of DVD , the disc tray and electronic swing panel closes, then playback starts.

**To remove the disc, press DVD .**

- After removing the disc, press DVD  again to close the disc tray.
- When you use the Resume function (see page 86), pressing DVD  erases the memory of the position where you have stopped playback.

**About the disc indicators**

When a DVD is loaded.



When a VCD or SVCD is loaded.



When an Audio CD or MP3 disc is loaded.

- The disc indicator rotates while a disc is being played.
- The disc indicator goes off when there is no disc in the disc tray.

## DVD Basic Operations

Available for:  DVD

- To play back a SVCD, VCD, or Audio CD, see page 30.
- To play back an MP3 disc, see page 32.
- Playback will stop when a disc menu appears on the TV screen. **If a menu appears while playing, see “Playing Back by Using the Disc Menu” on page 34.**

### 1 Load a disc.

- With some DVDs, playback starts automatically after you close the disc tray by pressing DVD .

### 2 Press DVD /|| on the main unit (or DVD SELECT on the remote control).

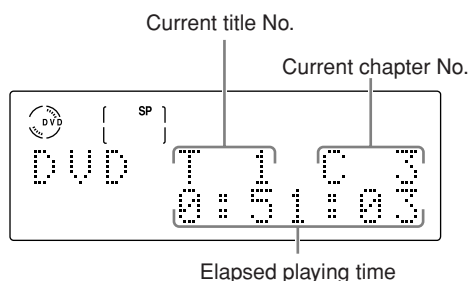

After reading the disc contents, playback starts from the first chapter of the first title.

- The disc playing information appears on the display.





**To stop play for a moment, press DVD /|| (or || on the remote control).**

While pausing, the elapsed playing time and the disc indicator flash on the display.

- To start playback again, press DVD /|| again (or press DVD SELECT  on the remote control).

**To stop playing, press .**

- This unit can store the stop point, and when you start playback again by pressing DVD /|| (or DVD SELECT  on the remote control), playback starts from the position where you have stopped—Resume play. (“RESUME” appears on the display.)



To use Resume play, you need to turn on the Resume function. (See page 86.)

- To stop completely when you use the Resume function, press  twice.

Playback will start from the beginning of the disc.

### To go to another chapter

Press  or  during playback.

- : Goes back to the beginning of the current or previous chapters.
- : Skips to the beginning of the next or succeeding chapters.



Some DVDs may not accept this operation.

### To go to a particular title or chapter directly using the number buttons

#### On the remote control ONLY:

- Pressing the number buttons before playback allows you to start playing with the title number you want.
- Pressing the number buttons during playback allows you to start playing with the chapter number of the currently playing title you want.

Ex.: To select number 5, press 5.

To select number 10, press 10.

To select number 20, press +10, +10 then 0.

To select number 23, press +10, +10 then 3.



**If a menu is shown on the TV while playing a DVD** Number buttons may be used for selecting an item in the menu. (See page 34.)

### To show the on-screen indication

You can show the following information on the TV while playing back a DVD.

#### On the remote control ONLY:

**To show the on-screen indication, press ON SCREEN** while playing a DVD.

- Each time you press the button, the indication on the TV change as follows:

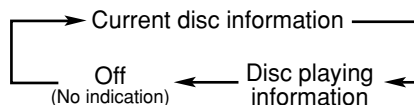



### • Current disc information

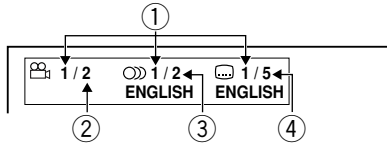

- ① : Current disc information
- ② : Total number of multi-angle views
- ③ : Total number of audio languages
- ④ : Total number of subtitles

### • Disc playing information

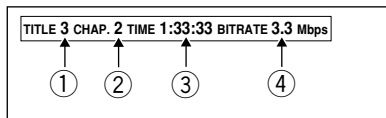

- ① : Current title number
- ② : Current chapter number
- ③ : Elapsed playing time of the current title
- ④ : Transmission rate

### To increase the DVD's sound level

The DVD's audio sound is recorded at a lower level than for other discs such as VCDs or Audio CDs.

If you feel the sound is not strong enough to listen to when playing back a DVD, you can increase the sound level of DVD playback in advance.

- Once you adjust this setting, it is effective every time you play back a DVD.
- This setting does not effect any discs other than DVDs.
- The audio output level through the DVD OPTICAL DIGITAL OUT terminal does not change if you change the DVD sound level.

#### On the remote control ONLY:

To increase the sound level of DVD playback, press DVD LEVEL while holding down SHIFT.

- Each time you press the buttons, the sound level changes as follows:



The selected level appears on the display.

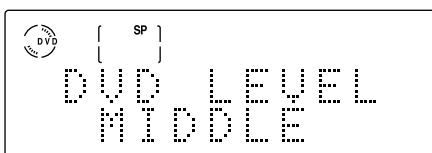

Ex.: When "MIDDLE" is selected.

- When you purchased this unit, the DVD sound level is set to "MIDDLE."

## SVCD/VCD/Audio CD Basic Operations

Available for: SVCD VCD Audio CD

- To play back a DVD, see page 29.
- To play back an MP3 disc, see page 32.
- While playing a SVCD or VCD with the PBC function, the playback will stop when a disc menu appears. **If a menu appears while playing a SVCD or VCD with PBC function, see "Playing Back by Using the Disc Menu" on page 34.**

- 1 Load a disc.
- 2 Press DVD ▷/II on the main unit (or DVD SELECT ► on the remote control).

After reading the disc contents, playback starts from the first track.

- The disc playing information appears on the display.

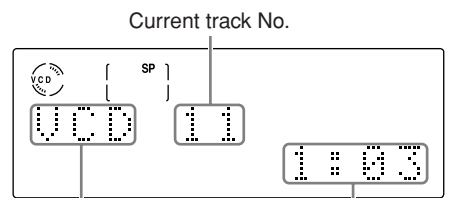

Ex.: When a VCD is played without the PBC function.

- \* About the indication of current disc type
  - "VCD": shows a SVCD or VCD is loaded.
  - "CD": shows an Audio CD is loaded.

- While playing a SVCD or VCD with the PBC function, "PBC" rather than the current track number appears in the main display and the PBC indicator lights up. (About the PBC function, see pages 34 and 35.)

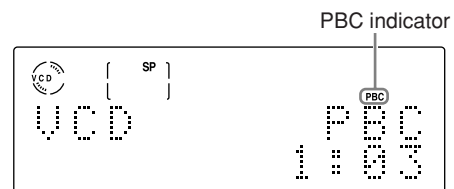

Ex.: When a VCD is played with the PBC function.

**To stop play for a moment**, press DVD ▷/⏸ (or ⏸ on the remote control).

While pausing, the elapsed playing time and the disc indicator flash on the display.

- To start playback again, press DVD ▷/⏸ again (or press DVD SELECT ► on the remote control).

**To stop playing**, press ■.

- This unit can store the stop point, and when you start playback again by pressing DVD ▷/⏸ (or DVD SELECT ► on the remote control), playback starts from the position where you have stopped—Resume play.

(“RESUME” appears on the display.)

To use the Resume play, you need to turn on the Resume function. (See page 86.)

–The Resume function does not work for Audio CDs.

–When using Resume play on SVCD or VCD with the PBC function, playback starts a little before the position where you have stopped.

- To stop completely when you use the Resume function, press ■ twice.

## To go to another track

Press ⏮ or ⏭ during playback.

- ⏮: Goes back to the beginning of the current or previous tracks.
- ⏭: Skips to the beginning of the next or succeeding tracks.



**While playing a SVCD or VCD with the PBC function**

The ⏭ and ⏮ buttons may be used for the operations for a disc menu. (See page 34.)

## To go to a particular track directly using the number buttons

**On the remote control ONLY:**

Pressing the number buttons before or during playback allows you to start playing with the track number you want.

Ex.: To select number 5, press 5.

To select number 10, press 10.

To select number 20, press +10, +10 then 0.

To select number 23, press +10, +10 then 3.



**While playing a SVCD or VCD with the PBC function**

If a menu is shown on the TV, number buttons may be used for selecting an item in the menu. (See page 34.)

## To show the on-screen indication

You can show the following information on the TV while playing back a disc.

**On the remote control ONLY:**

**To show the on-screen indication**, press ON SCREEN while playing a disc.

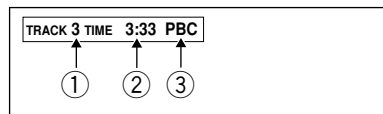

Ex.: When SVCD or VCD with the PBC function is a playing source.

① : Current track number

② : Elapsed playing time of the current track

- ③ : • “PBC” is shown when a SVCD or VCD with the PBC function is played.  
• “EACH” is shown when a SVCD or VCD without the PBC function or an Audio CD is played.

**To erase the on-screen indication**, press ON SCREEN again.

## MP3 Basic Operations

Available for:  MP3

- To play back a DVD, see page 29.
- To play back a SVCD, VCD, or Audio CD, see page 30.

### About MP3 disc

#### What is MP3?

MP3 is an abbreviation of Motion Picture Experts Group 1 (or MPEG-1) Audio Layer 3. MP3 is simply a file format with a data compression. By using MP3 format, one CD-R or CD-RW can contain 10 times as much data volume as a regular CD can.

#### Disc structure

On an MP3 disc, each item (song) is recorded as a track (file), which usually belongs to a group (folder).



This unit can recognize up to 99 groups and up to 254 tracks per group; however, the number of tracks to be played back on a disc is limited to 1023.

If a disc includes more than 1023 tracks, the unit ignores any tracks which have been assigned track numbers exceeding 1023. The unit also ignores any non-MP3 files on the disc.

#### NOTES for MP3 discs

- MP3 discs (either CD-R or CD-RW) require a longer readout time, due to the complexity of the folder/file configuration.
- When making an MP3 disc, select ISO 9660 Level 1 or Level 2 as the disc format.
- Some MP3 discs may not be played back because of their disc characteristics or recording conditions.
- The unit does not support "packet writing" of discs.
- If there are any tracks (files) which are stored on a disc directly and do not belong to any group (folder), the unit recognizes them as belonging to a particular group.
- The unit does not output a digital audio signal from the DVD OPTICAL DIGITAL OUT terminal when playing back an MP3 disc.
- The unit plays back groups/tracks on an MP3 disc in alphabetical order.

Ex.: When there are three title groups [one], [two] and [three] on a disc:

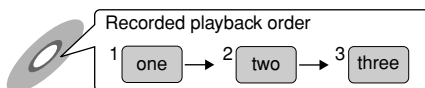

The playback order on this unit is [one], [three] then [two].

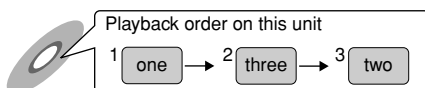

Tracks in a group are played back in the same way.

An MP3 disc on the market may be played back in a different order from the order printed on its sleeve.

### Unavailable functions for MP3 disc

- There are some restriction for playback of MP3 discs. Following functions are not available for MP3 discs.
  - Screen saver function (See page 28.)
  - Forward/Reverse search (See page 33.)
  - A-B repeat (See page 36.)
  - Time search (See page 50.)
  - 3D PHONIC (See page 55.)
  - Resume playback (See page 86.)
- This unit cannot show the names of tracks (files) and groups (folders) on an MP3 disc.

#### 1 Load a disc.

#### 2 Press DVD ▷/|| on the main unit (or DVD SELECT ► on the remote control).

After reading the disc contents, playback starts.

- The disc playing information appears on the display.

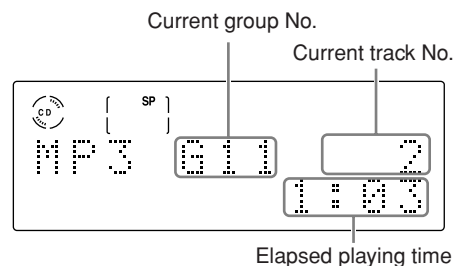

**To stop play for a moment**, press DVD ▷/|| (or || on the remote control).

While paused, the elapsed playing time and the disc indicator flash on the display.

- To start playback again, press DVD ▷/|| again (or press DVD SELECT ► on the remote control).

**To stop playing**, press ■.

#### To go to another track

Press |◀◀ or ▶▶| during playback.

- |◀◀: Goes back to the beginning of the current or previous tracks.
- ▶▶|: Skips to the beginning of the next or succeeding tracks.



#### While playback is stopped

You cannot select a track. The |◀◀ and ▶▶| buttons works to select groups.

## To go to another group

### On the remote control ONLY:

Press GROUP SKIP ◀◀ or GROUP SKIP ▶▶ while holding down SHIFT during playback.

- GROUP SKIP ◀◀: Goes back to the previous groups.
- GROUP SKIP ▶▶: Skips to the beginning of the next or succeeding groups.



#### While playback is stopped

You can select a group by pressing ◀◀ or ▶▶.

## To go to a particular group or track directly using the number buttons

### On the remote control ONLY:

#### To select the group you want to play

Press the number buttons to select a group number (up to 99) while playback is stopped.

Ex.: To select number 5, press 5.

To select number 10, press 10.

To select number 20, press +10 then 10.

To select number 23, press +10, +10 then 3.

#### To select the track you want to play

Press the number buttons to select a track number (up to 254) during playback.

Ex.: To select number 5, press 5.

To select number 10, press 10.

To select number 20, press +10, +10 then 0.

To select number 23, press +10, +10 then 3.

To select number 150, press +10 fifteen times, then 0.

## To show the on-screen indication

You can show the following information on the TV while playing back a disc.

### On the remote control ONLY:

To show the on-screen indication, press ON SCREEN while playing a MP3 disc.

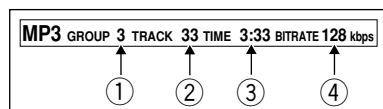

- ① : Current group number
- ② : Current track number
- ③ : Elapsed playing time of the current track
- ④ : Transmission rate\*

\* The transmission rate will change according to the recording conditions. This is not a malfunction.

To erase the on-screen indication, press ON SCREEN again.

## Searching for a Particular Point

Available for: DVD SVCD VCD Audio CD

You can search for a particular portion while playing a disc —Forward/Reverse search.

- When playing a DVD, SVCD, or VCD disc, no sound comes out during Forward/Reverse Search.

### On the remote control:

#### Forward search

To fast-forward the chapter or track, press ▶▶ while playing a disc.

- Each time you press the button, the search speed increases.

#### Reverse search

To fast-reverse the chapter or track, press ◀◀ while playing a disc.

- Each time you press the button, the search speed increases.

To go back to normal play, press DVD SELECT ▶ (or DVD ▷/|| on the main unit).



When playing a DVD, SVCD, or VCD disc The current search speed (x2 to x60) appears on the TV.

**On the main unit:****Forward search**

To fast-forward the chapter or track, press and hold ►► while playing a disc.

- If you keep holding down the button for a certain period of time, the search speed increases.

**Reverse search**

To fast-reverse the chapter or track, press and hold ◀◀ while playing a disc.

- If you keep holding down the button for a certain period of time, the search speed increases.

To go back to normal play, release the button.



When playing a DVD, SVCD, or VCD disc

The current search speed (x2 and x20) appears on the TV.

## Playing Back by Using the Disc Menu

Available for:  DVD  SVCD  VCD

Some DVDs are recorded with their own menus which show their contents. SVCDs or VCDs with the Playback Control (PBC) function also have their own menus, such as lists of songs. You can play back the discs by using these menus.

**■ When playing a DVD**

DVD discs generally have their own menus which show the disc contents. These menus contain various items such as titles of movies, names of songs, or artist information, and display them on the TV screen. You can play back by using these menus.

**On the remote control ONLY:****1 Press TOP MENU or MENU.**

The menu appears on the TV.

Ex.:

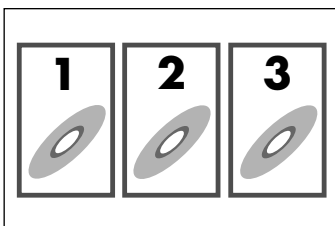

Normally, a DVD containing more than one title will list the titles in a title menu. Press TOP MENU to show the title menu.

Some DVD discs may also have a different menu which is shown by pressing MENU.

- See the instructions of each DVD disc for its particular menu.

**2 Use Cursor ◀/▶/▲/▼ to select a desired item, then press ENTER.**

Playback of the selected item starts.

- With some discs, you can also select items by entering the corresponding number using the number buttons.

**■ When playing a SVCD or VCD**

When a SVCD or VCD with the Playback Control function (PBC) is detected, the PBC indicator lights up on the display. The PBC function allows you to operate the SVCD or VCD by using menus.

When you start playback, a menu automatically appears on the TV screen.

- A menu may be a list of items, divided screens, or some moving pictures. (See “PBC operation concept” on the next page.)
- See also the instructions of each disc for its particular menu.

Ex.:

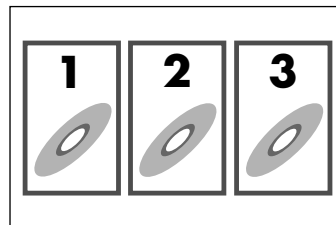
**On the remote control ONLY:**

To select the number of the desired item, press the number buttons.

Ex.: To select number 5, press 5.

To select number 10, press 10.

To select number 20, press +10, +10 then 0.

To select number 23, press +10, +10 then 3.

The system starts playback from the selected item.

To return to the previous menu, press RETURN while holding down SHIFT.

**When “NEXT” or “PREVIOUS” is shown on the menu:**

You can go to other pages of the menu.

- To go to the next page, press NEXT (►►).
- To return to the previous page, press PREV. (◀◀).

## PBC operation concept

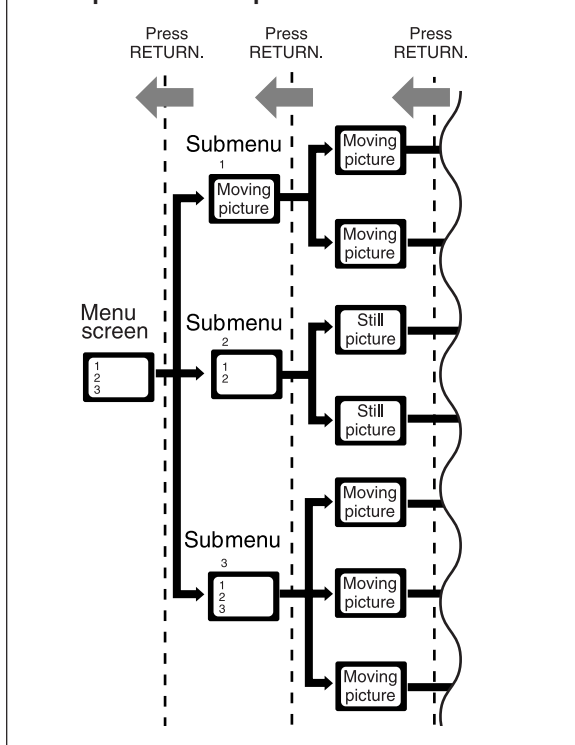

### To cancel the PBC function:

- 1 Press **■** during playback.  
Playback stops.
- 2 Press the number buttons to select the track number you want to play.  
Playback starts from the selected track without the PBC function.

To activate the PBC function again, press **■** once or twice to stop playback completely, then press DVD SELECT **▶**.

- When you use the Resume function, press **■** twice to stop playback completely.

You can also activate the PBC function during playback without the PBC function as follows:

- 1 Press PLAY MODE.  
The play mode screen appears on the TV.  

  - 2 Use Cursor **◀▶** to move **▶** to "PBC CALL," then press ENTER.
- You cannot cancel the PBC function from the play mode screen.

## Repeating Playback

### Repeat play

Available for: DVD SVCD VCD Audio CD MP3

You can repeat playback of disc's contents as follows:

- **For DVD:** You can repeat the current title or chapter.
  - The repeat play cannot be used on some DVD discs.
  - For DVD, you can select "REPEAT" only during playback.
- **For SVCD, VCD, or Audio CD:** You can repeat a track or all tracks.
  - You can only use the repeat play on SVCD or VCD without the PBC function.
- **For MP3 disc:** You can repeat a groups or all groups.

### On the remote control ONLY:

- 1 Press PLAY MODE before or during play.  
The play mode screen appears on the TV.

**REPEAT PROGRAM RANDOM**

Ex.: While playback is stopped.

**REPEAT A-B REPEAT TIME SEARCH CHAP. SEARCH**

Ex.: During DVD playback.

- 2 Press Cursor **◀▶** to move **▶** to "REPEAT."

- 3 Press ENTER repeatedly to select the repeat play mode you want.

The selected repeat mode is shown on the TV and in the main display of this unit.

- Each time you press the button, the repeat play mode changes as follows:

### For DVD:

Ex.: During playback.

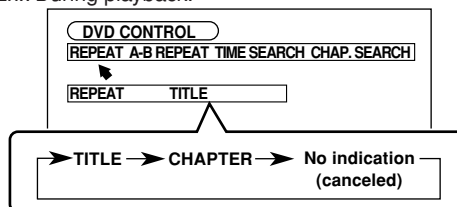

- **TITLE:** Current title will be repeated.
- **CHAPTER:** Current chapter will be repeated.

**For SVCD, VCD, or Audio CD:**

Ex.: During VCD playback.

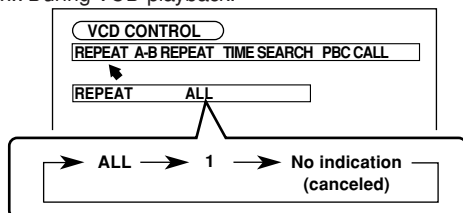

- **ALL:** All tracks on the disc or all tracks in the program will be repeated.
- **1:** Current track will be repeated.

**For MP3 disc:**

Ex.: During playback.

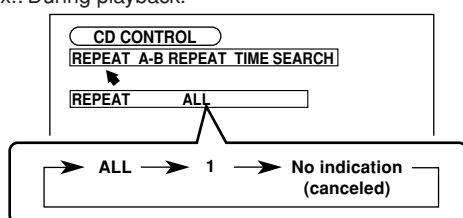

- **ALL:** All groups on the disc or all groups in the program will be repeated.
- **1:** Current group will be repeated.

The corresponding repeat mode indicators light up on the display.

- When "TITLE" or "ALL" is selected:  
The **ALL** indicator lights up on the display.
- When "CHAPTER" or "1" is selected:  
The **1** indicator lights up on the display.

**■ A-B repeat play**

Available for: DVD SVCD VCD Audio CD

While playing, you can select a portion you want to repeat.

- During the program play (see page 37), random play (see page 39), or repeat play, you cannot perform the A-B repeat play.
- You cannot perform the A-B repeat play between different chapters or different titles on a DVD.

**On the remote control ONLY:**

- 1** Press **PLAY MODE** during play.  
The play mode screen appears on the TV.
- 2** Press **Cursor** to move to "A-B REPEAT."

**REPEAT A-B REPEAT TIME SEARCH CHAP. SEARCH**

Ex.: While a DVD is played back.

- 3** Press **ENTER** at the starting point from which you want to repeat (point A).  
The A-B repeat indication appears on the TV.

**A 1:12:34 → B \_:\_\_:\_\_**

- The following indication also appears on the display.

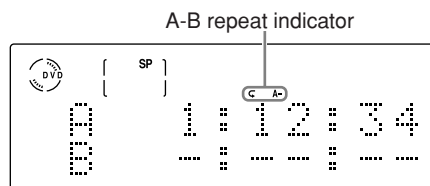

- 4** Press **ENTER** again at the end point to which you want to repeat (point B).

The A-B repeat play begins.

The unit automatically locates point A and starts repeating the portion between points A and B.

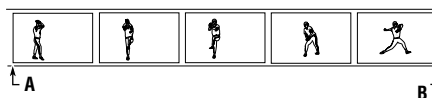

**To erase the play mode screen, press PLAY MODE.**

**To cancel the A-B repeat play, press ENTER.**

The A-B repeat play is canceled and normal playback continues from that point.

## Programming the Playing Order —Program Play

Available for: DVD SVCD VCD Audio CD MP3

You can arrange the order of playback before you start playing.

- **For DVD:** You can arrange the order in which the titles play.
  - The program play cannot be used on some DVD discs.
- **For SVCD, VCD, Audio CD:** You can arrange the order in which the tracks play.
- **For MP3 disc:** You can arrange the order in which the groups play.
  - You can program up to 18 steps.
  - You cannot perform the program play while the random play is activated. (See page 39.)

### On the remote control ONLY:

- 1** Load a disc.
- 2** Press DVD SELECT ►, then ■. The source is changed to the DVD player and playback is stopped.
- 3** Press PLAY MODE. The play mode screen appears on the TV.
 

REPEAT	PROGRAM	RANDOM
1	2	3
4	5	6
7	8	9
10	11	12
13	14	15
16	17	18
- 4** Press Cursor ►/◀ to move to “PROGRAM,” then press ENTER. The program screen appears on the TV.

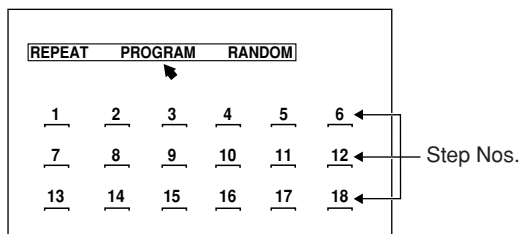

The PRGM (program) indicator lights up on the display.

- 5** Press the number buttons to enter a title, track, or group number you want to program.

The selected number is shown on the program screen.  
Ex.: To select number 5, press 5.

To select number 10, press 10.

To select number 20, press +10 +10 then 0.

To select number 23, press +10, +10 then 3.

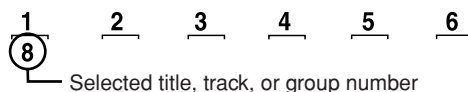

- 6** To program other titles, tracks, or groups, repeat step 5.

REPEAT	PROGRAM	RANDOM
1	2	3
4	5	6
7	8	9
10	11	12
13	14	15
16	17	18

- You can also check the program settings on the display.

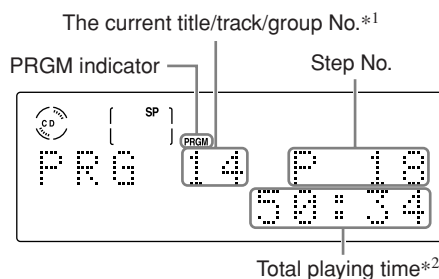

Ex.: When an Audio CD is loaded and 18 tracks have been programmed.

\*1 • When a DVD is loaded, “T” (title) appears before the number.

• When an MP3 disc is loaded, “G” (group) appears before the number.

\*2 When a DVD or an MP3 disc is loaded, the total playing time does not appear.

- 7** Press DVD SELECT ►.

The program screen goes off and your program starts playing.

- If you press one of the recording buttons—ONE TOUCH MD REC, ONE TOUCH TAPE REC, or MD&TAPE REC, you can start recording. (See “Recording” on pages 56 to 64.)



**To stop playing, press ■.**

Playback stops, but the program play is still activated.

- To exit from the program play, see “To exit from the program play” on the right column.

**To go to the next steps, press ►►.**

- You cannot go back to the previous steps by pressing ◀◀.

**If your entry is ignored**

You have tried to program a title/track/group number that does not exist on the disc (for example, selecting track 14 on a disc that only has 12 tracks). Such entries are ignored.

**If the total playing time exceeds 100 minutes**

The total playing time in the main display will not be shown. (“--:--” will appear.)

**To check the programmed contents****On the TV:**

Press PLAY MODE. The programmed contents appear on the TV.

To erase the play mode screen, press PLAY MODE.

**On the display:**

Press ►► or ◀◀ while the program play is stopped.

- ►►: Shows the programmed tracks in the programmed order.
- ◀◀: Shows them in the reverse order.

**To modify the program**

You can modify the program before or after playing.

**To show the program screen:**

**1** Press PLAY MODE while the program play is stopped.

The program screen appears on the TV.

- If you press the button during playback, the program screen appears on the TV, but you cannot modify your program.

**2** Press Cursor ►/◀ to move  to “PROGRAM.”

Now you can modify your program.

**To erase the last step, press CANCEL.**

- Each time you press the button, the last programmed step is erased from the program.

**To add steps in the program before play**, simply select the numbers you want to add by pressing the number buttons.

**To erase the entire program**, press and hold CANCEL for about 3 seconds.

- Ejecting the disc or turning off the unit also erase the program.

**To exit from the program play**

When the program play is stopped, perform steps **3** and **4** on page 37 so that the program screen disappears from the TV.

“PROGRAM OFF” appears in the main display and the PRGM (program) indicator goes off.

To erase the play mode screen, press PLAY MODE.

- Each time you press ENTER in step **4**, the program play turns on and off.
- Ejecting the disc or turning off the unit will also cancel the program play and erase the program.

## Playing at Random—Random Play

Available for:  DVD  SVCD  VCD  Audio CD  MP3

You can play disc's contents in random order.

- **For DVD:** You can play the titles in random order.
  - The random play cannot be used on some DVD discs.
- **For SVCD, VCD, Audio CD:**

You can play the tracks in random order.
- **For MP3 disc:**

You can play the groups in random order.
- You cannot perform the random play while the program play is activated. (See page 37.)

### On the remote control ONLY:

**1** Load a disc.

**2** Press DVD SELECT ►, then ■.

The source is changed to the DVD player and playback is stopped.

**3** Press PLAY MODE.

The play mode screen appears on the TV.

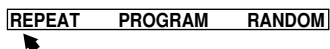

**4** Press Cursor ►/◀ to move ► to “RANDOM,” then press ENTER.

“RANDOM” appears under the play mode screen.

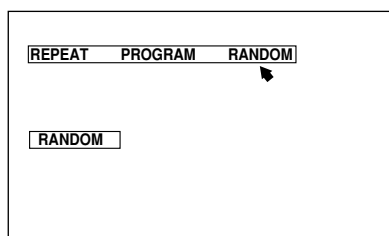

“RANDOM ON” appears in the main display and the RANDOM indicator lights up.

**5** Press DVD SELECT ►.

Playback starts in random order.

The random play ends when all titles, tracks, or groups are played once.

- If you press one of the recording buttons—ONE TOUCH MD REC, ONE TOUCH TAPE REC, or MD&TAPE REC, you can start recording. (See “Recording” on pages 56 to 64.)

**To skip the playing title, track, or group,** press ►►.

- You cannot go back to the previous title, track, or group by pressing ◀◀.

**To stop playing,** press ■.

Playback stops, but the random play is still activated.

- To exit from the random play, see “To exit from the random play” below.

### To exit from the random play

When the random play is stopped, perform steps **3** and **4** so that “RANDOM” disappears from the TV.

“RANDOM OFF” appears in the main display and the RANDOM indicator goes off.

To erase the play mode screen, press PLAY MODE.

- Each time you press ENTER in step **4**, the random play mode turns on and off.
- Ejecting the disc or turning off the unit will also cancel the random play.

# Playing Back MDs

The buttons emphasized in the illustration below are used and explained in following section (pages 41 to 46).

## Remote control

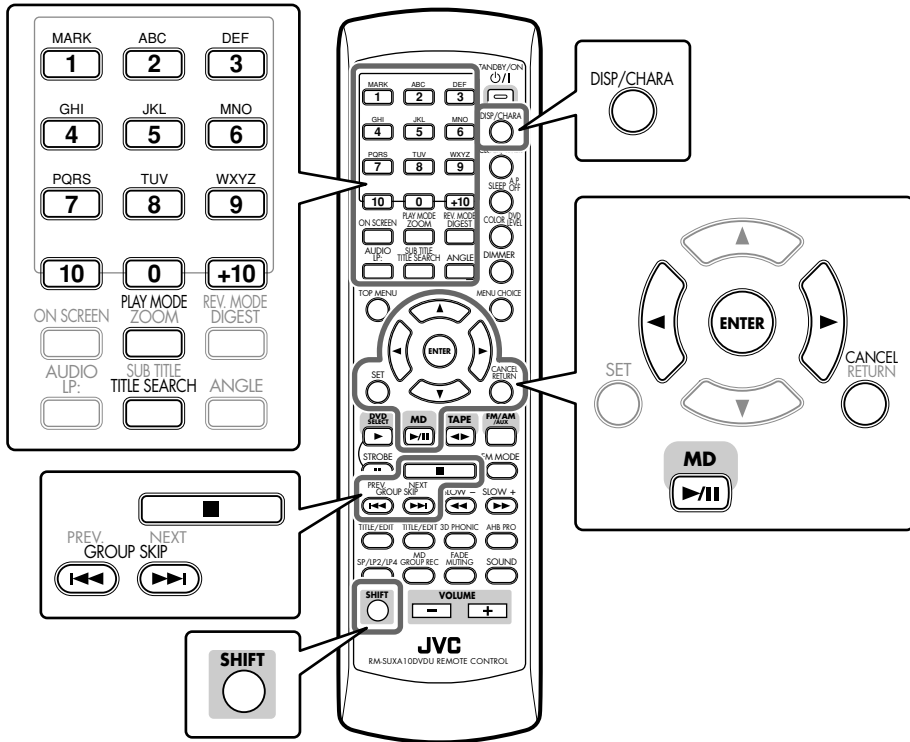

## Main unit

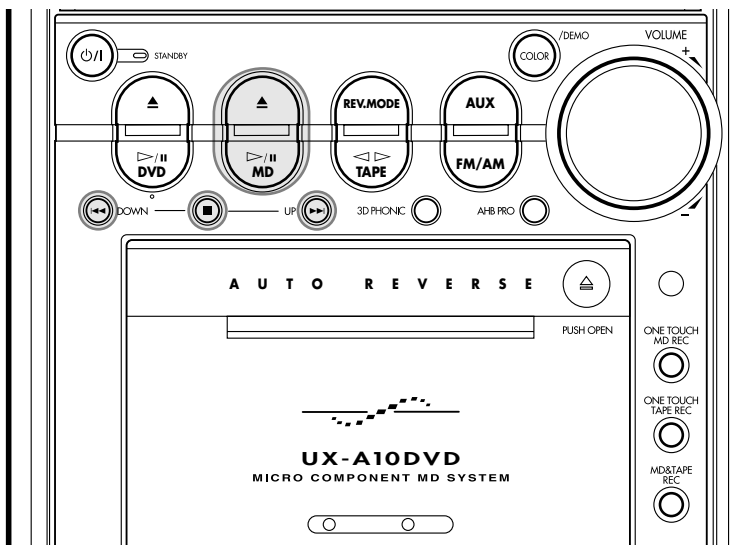

## Playing Back the Entire MD

### 1 Press MD ▲ on the main unit.

The unit automatically turns on, the electronic swing panel slides upward, then the MD loading slot appears.

- If an MD is already in the MD loading slot, it will be ejected.

### 2 Insert an MD into the MD loading slot.

The MD is pulled in, then the electronic swing panel slides downward automatically.

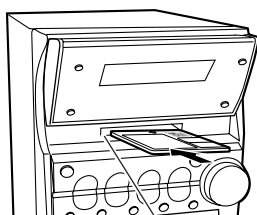

Insert an MD in the same way as indicated on the MD.

MD loading slot

- When the current source is MD, the information on the loaded MD appears in the main display as follows:

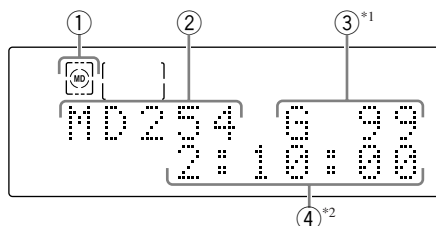

- ① MD indicator
- ② Total track No.
- ③ Total group No. (when the MD has groups)\*<sup>1</sup>
- ④ Total playing time\*<sup>2</sup>

\*<sup>1</sup> When the loaded MD has no group, the total group number will be indicated as “—.”

\*<sup>2</sup> When the loaded MD has a title, it will appear in the main display before the total playing time appears.

### 3 Press MD ►/II.

The MD indicator starts flashing on the display and MD playback starts from the first track.

- The recording length mode (SP/LP2/LP4) appears in the main display. (About the recording length mode, see the right column.)

MD playback stops automatically after playing all the tracks on the MD.

To stop playing, press ■.

To remove the MD, press MD ▲.

- After removing the MD, press MD ▲ again to close the electronic swing panel.



While the unit is pulling in the MD:

- DO NOT press MD ▲.
- DO NOT close the electronic swing panel by force.

#### About the MD indicator



An MD is loaded.



During playback.



During pause.



#### If the MD or track has a title

The title will appear in the main display for a while. (If a title is long and cannot be shown at a time, the unit scrolls the title to show the entire title.)



#### About recording length mode

MDs are played back in the same recording length mode as they were recorded. When an MD starts playing, the playback mode of the currently playing track appears in the main display.

**SP:** Indicates the tracks recorded in standard stereo recording mode on this unit or those recorded on an MD recorder incompatible with MDLP (see below).

**LP2:** Indicates the tracks recorded in 2 times long-hour stereo recording mode.

**LP4:** Indicates the tracks recorded in 4 times long-hour stereo recording mode.

For more details, see page 58.

MDLP features a new sound compression method (ATRAC3) and a 2 times (or 4 times) long-hour stereo recording and playing function.

The MDLP logo is marked on the MD recorders and players compatible with MDLP. It is also marked on MDs pre-recorded in ATRAC3 (excluding recordable MDs).

## MD Basic Operations

While playing an MD, you can do the following operations.

### To stop playback for a moment

Press MD ►/II.

The MD indicator and the elapsed playing time start flashing on the display.

To resume playback, press MD ►/II again.

### To locate a particular point in a track during play

#### On the remote control:

Press ►► or ◀◀.

- ►►: Fast-forwards the track.
- ◀◀: Fast-reverses the track.

To go back to normal play, press MD ►/II.

**On the main unit:**

Press and hold ►► or ◀◀.

- ►►: Fast-forwards the track.
- ◀◀: Fast-reverses the track.

To go back to normal play, release the button.

**To go to another track**

Press ►► or ◀◀ repeatedly.

- ►►: Skips to the beginning of the next or succeeding tracks.
- ◀◀: Goes back to the beginning of the current or previous tracks.

**To go to another track directly using the number buttons****On the remote control ONLY:**

Pressing the number button(s) allows you to start playing the track number you want.

Ex.: For track number 5, press 5.

For track number 15, press +10, then 5.

For track number 20, press +10, then 10.

For track number 32, press +10, +10, +10, then 2.

**To change the information shown in the main display****On the remote control ONLY:**

Each time you press DISP/CHARA, the information in the main display changes as follows:

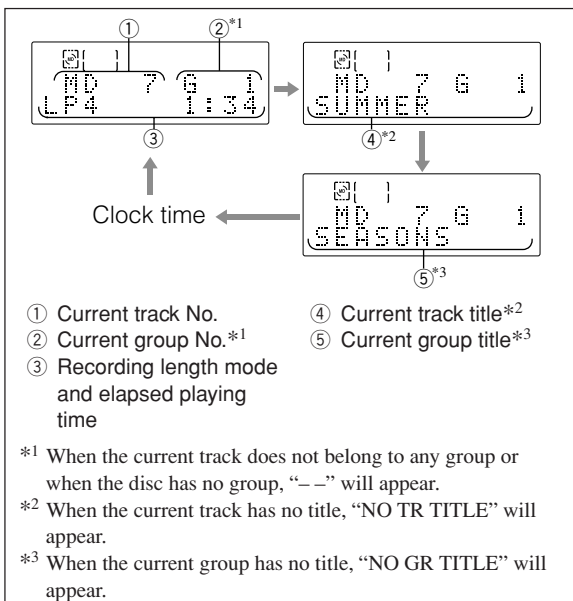
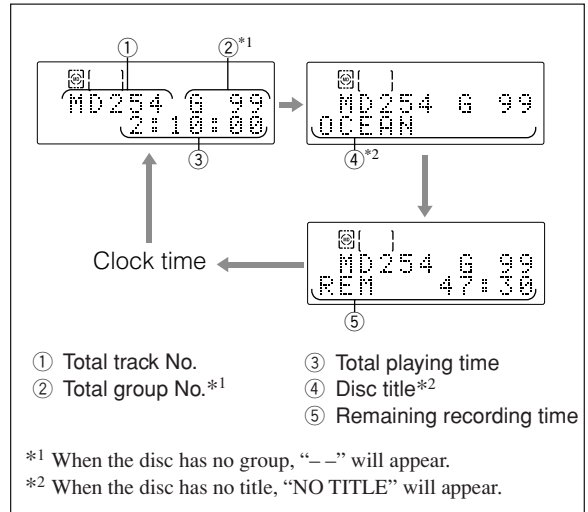
**While playing or pausing:****While stopped:****Repeating Tracks—Repeat Play**

You can repeat all the tracks, the program, a group or the individual track currently playing as many times as you like.

- You cannot perform the A-B repeat play for MDs.

**On the remote control ONLY:**

- 1 Press **PLAY MODE** during or before play. “REPEAT” appears in the main display.

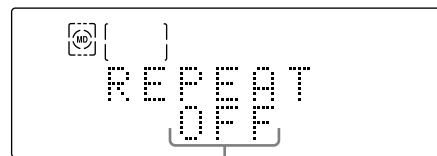

Current setting also appears.

- 2 Press **ENTER** repeatedly to select the repeat play mode you want.

- Each time you press the button, the repeat play mode changes as follows:

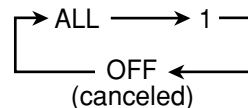

Continued next page ➔

- **ALL:**
    - For normal play or the random play:  
Repeats all the tracks on the MD.
    - For the program play mode:  
Repeats the program.
    - For the group play mode:  
Repeats all the tracks in a group.
- The **ALL** indicator lights up on the display.
- **1:**  
Repeats one track.  
The **1** indicator lights up on the display.

To return to the normal display, press PLAY MODE.

To stop playing, press ■.

To cancel the repeat play, perform steps 1 and 2 on page 42, so that “REPEAT OFF” appears in the main display and the repeat mode indicator goes off.

To return to the normal display, press PLAY MODE.

- Ejecting the MD or turning off the unit will also cancel the repeat play.

## Programming the Playing Order of the Tracks —Program Play

You can arrange the order in which the tracks play before you start playing. You can program up to 32 tracks.

- You cannot perform the program play while the random play (see page 44) or the group play (see page 45) is activated.

### On the remote control ONLY:

- 1** Load an MD.
- 2** Press MD ►/||, then ■.  
The source is changed to “MD” and playback is stopped.
- 3** Press PLAY MODE.  
“REPEAT” (with its current setting) appears in the main display.
- 4** Press Cursor ►/◀ so that “PROGRAM” appears in the main display.

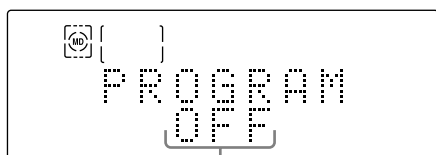

Appears only when the program play is deactivated.

- When the program play is activated, the program entry display appears in the main display after a few seconds. (See step 5.)
- Each time you press the button, play mode changes as follows:

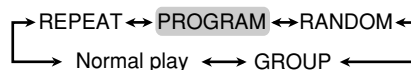

- 5** Press ENTER to enter the program play.  
The program entry display appears in the main display.

PRGM (program) indicator lights up.

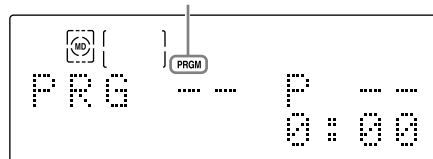

- Each time you press the button, the program play turns on and off.

- 6** Press the number buttons to select the tracks you want to program.

Ex.: For track number 5, press 5.

For track number 15, press +10, then 5.

For track number 20, press +10, then 10.

For track number 32, press +10, +10, +10, then 2.

The last programmed track No.      Step No.

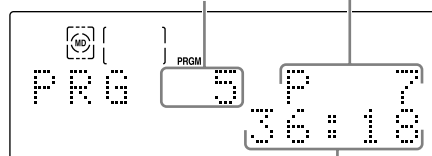

Total playing time

Ex.: Seven tracks have been programmed.

- 7** Press MD ►/||.  
The tracks are played in the order you have programmed.  
The program play ends when all the programmed tracks are played back.

To stop playing, press ■.

Playback stops, but the program play is still activated.

- To exit from the program play, see “To exit from the program play” on the next page.



#### If your entry is ignored

You have tried to program a track that does not exist on the MD (for example, selecting track 14 on an MD that only has 12 tracks). Such entries are ignored.



#### If you try to program a 33rd step

“MEMORY FULL” will appear in the main display.



#### If the total playing time exceeds 150 minutes

The total playing time will not be shown. (“- : -” will appear.)

### To check the program contents

Press ►►| or |◄◄ while the program play is stopped.

- ►►|: Shows the programmed tracks in the programmed order.
- |◄◄: Shows them in the reverse order.

### To modify the program

You can modify the program before or after playing.

**1** Press PLAY MODE while the program play is stopped. “REPEAT” appears in the main display.

**2** Press Cursor ►/◄ so that “PROGRAM” appears in the main display. “PROGRAM” turns into the program entry display after a few seconds.

Now you can modify your program.

**To erase the last step**, press CANCEL.

- Each time you press the button, the last programmed step is erased from the program.

**To add steps in the program before play**, simply select the track numbers you want to add by pressing the number buttons.

**To erase the entire program**, press and hold CANCEL for about 3 seconds.

- Ejecting the MD or turning off the unit also erase the program.

### To exit from the program play

When the program play is stopped, perform steps **3** to **5** on page 43 so that “PROGRAM OFF” appears in the main display and the PRGM (program) indicator goes off.

To return to the normal display, press PLAY MODE.

- Each time you press ENTER in step **5**, the program play turns on and off.
- Ejecting the MD or turning off the unit will also cancel the program play and erase the program.

## Playing at Random—Random Play

You can play MD’s contents in random order.

- You cannot perform the random play while the program play (see page 43) or the group play (see page 45) is activated.

### On the remote control ONLY:

**1** Load an MD.

**2** Press MD ►/II, then ■.

The source is changed to “MD” and playback is stopped.

**3** Press PLAY MODE.

“REPEAT” (with its current setting) appears in the main display.

**4** Press Cursor ►/◄ repeatedly so that “RANDOM” (with its current setting) appears in the main display.

- Each time you press the button, play mode changes as follows:

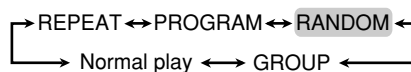

**5** Press ENTER to enter the random play.

RANDOM indicator lights up.

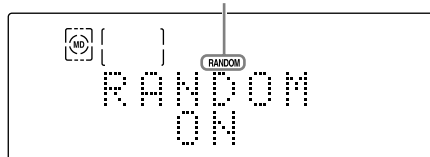

- Each time you press the button, the random play turns “ON” and “OFF.”

**6** Press MD ►/II.

Playback starts in random order.

The random play ends when all the tracks are played once.

**To skip the playing track**, press ►►|.

- You cannot go back to the previous tracks by pressing |◄◄.

**To stop playing**, press ■.

“MD RANDOM” appears in the main display.

### To exit from the random play

When the random play is stopped, perform steps **3** to **5** so that “RANDOM OFF” appears in the main display and the RANDOM indicator goes off.

To return to the normal display, press PLAY MODE.

- Ejecting the MD or turning off the unit will also cancel the random play.

## Playing Tracks in a Group—Group Play

You can play back only tracks in a group.

- To make or edit groups, see pages 66 to 74.
- You cannot perform the group play while the program play (see page 43) or the random play (see page 44) is activated.

### On the remote control ONLY:

**1** Load an MD including (a) groups.

**2** Press MD ►/II, then ■.

The source is changed to “MD” and playback is stopped.

**3** Press PLAY MODE.

“REPEAT” (with its current setting) appears in the main display.

**4** Press Cursor ►/◀ repeatedly so that “GROUP” (with its current setting) appears in the main display.

- Each time you press the button, play mode changes as follows:

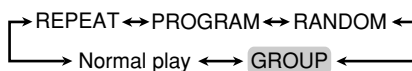

**5** Press ENTER to enter the group play.

GROUP indicator lights up.

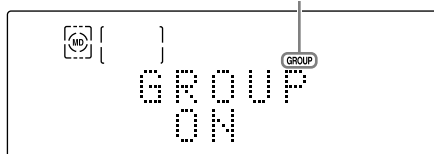

- Each time you press the button, the group play turns “ON” and “OFF.”

**6** Press MD ►/II.

The tracks in the selected group are played.

- When the loaded MD has no groups, all the tracks on the MD are played back in the same way as in normal play.

The group play ends when all the tracks in the selected group are played back.

To go to another group, press GROUP SKIP ►►| or GROUP SKIP |◀◀ while holding down SHIFT.

- GROUP SKIP ►►|: Skips to the first track in the next or succeeding groups.
- GROUP SKIP |◀◀: Goes back to the first track in the current or previous groups.

To go to another track in the same group, press ►►| or |◀◀ repeatedly.

- ►►|: Skips to the beginning of the next or succeeding tracks.
- |◀◀: Goes back to the beginning of the current or previous tracks.

To stop playing, press ■.

### To exit from the group play

When the group play is stopped, perform steps **3** to **5** so that “GROUP OFF” appears in the main display and the GROUP indicator goes off.

To return to the normal display, press PLAY MODE.

- Pressing one of number buttons also cancels the group play and starts normal play from the track selected by the button.
- Ejecting the MD or turning off the unit will also cancel the random play.



## Searching for Tracks to Play —MD Title Search

You can search for the tracks by their titles and play them back.

For details on assigning a title, see pages 80 to 82.

### On the remote control ONLY:

**1** Load an MD.

**2** Press MD ►/II, then ■.

The source is changed to “MD” and playback is stopped.

**3** Press TITLE SEARCH while holding down SHIFT.

“TITLE” and the character entry position appear in the main display and the TITLE SEARCH indicator lights up on the display.

The play mode changes to normal play.

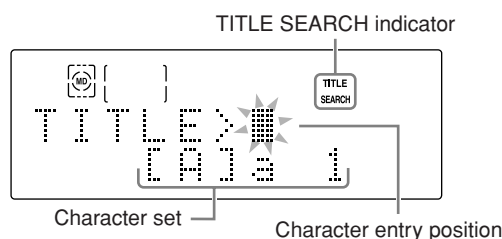

**4** Enter the character(s) to search for the track title.

You can enter up to 5 characters. The unit will search for the tracks which have the entered characters at the head of their titles.

- You can also search for the tracks which do not have a title. In this case, go to step **5** without entering any character.

**1) Press DISP/CHARA to select the character set you want.**

- Each time you press the button, the character set changes as follows:

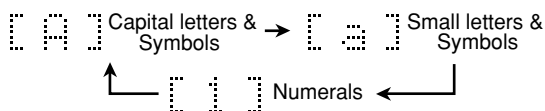

**2) Press the character entry button for a character you want to enter.**

Ex.:

- To enter an “A” or “a,” press ABC once.
- To enter a “B” or “b,” press ABC twice.
- To enter a “C” or “c,” press ABC three times.
- To enter a symbol, press MARK repeatedly until the mark you want appears.

Available symbols:

(Blank)	!	"	#	\$	%	&	'	( )
*	+	,	-	.	/	:	;	< =
>	?	@	_	\				

- To enter a numeral, press 0 – 9.
- To enter a space while entering a title, press Cursor ► twice.
- To move the character entry position while entering a title, press Cursor ► or ◀.
- If you have entered an incorrect character, press Cursor ► or ◀ to select the character you want to correct, then press CANCEL to delete it.

**3) Repeat steps 4 – 1) and 4 – 2) to enter other characters.**

- If the character you want to enter next is assigned to the same button you have just pressed in step 4 – 2), press Cursor ► once to move the character entry position to the right.

**5** Press ENTER.

“SEARCH .....” scrolls and the TITLE and SEARCH indicators start flashing on the display. The unit starts searching for the track.

- When the track with the desired title is found, the unit plays back the track. (After the track is played, the unit starts searching for the next matching track.)
- If no track with the desired title is found, “SEARCH END” appears in the main display and Normal play mode resumes (the TITLE and SEARCH indicators go off).

**To skip the current playing track and search for the next track, press ►►.**

**To cancel the title searching, press TITLE SEARCH while holding down SHIFT.**

When you press the buttons during playback or search, normal play resumes.

# Playing Back Tapes

The buttons emphasized in the illustration below are used and explained in the following section (page 48).

## Remote control

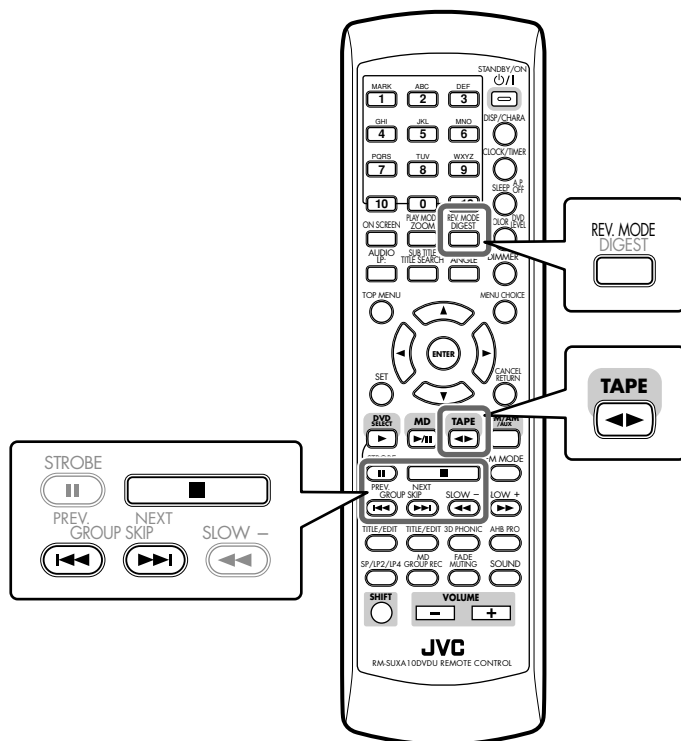

## Main unit

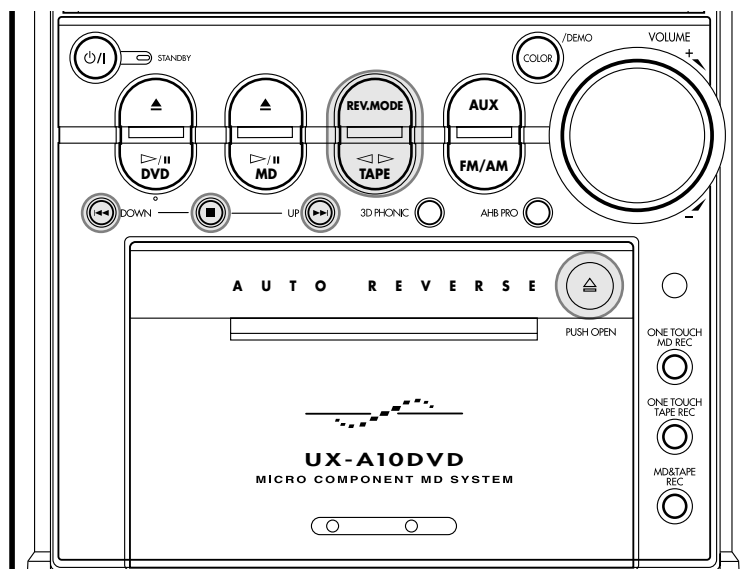

## Playing Back a Tape

You can play back type I tapes.

- 1** Push  $\triangle$  (PUSH OPEN).  
The cassette holder opens.

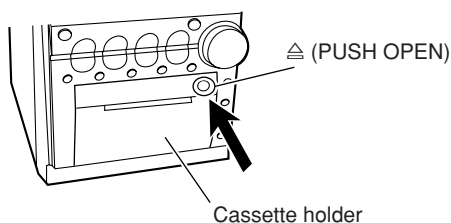

- 2** Put a cassette in with the exposed part of the tape down.

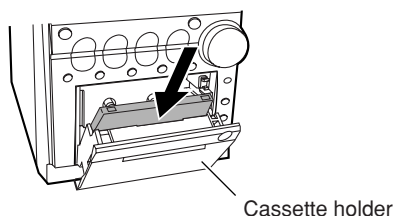

- 3** Push  $\triangle$  (PUSH OPEN) gently to close the cassette holder.

- 4** Press TAPE  $\blacktriangleleft\blacktriangleright$ .

Playback starts (if the unit is in standby, the unit automatically turns on).

To change the tape direction, press TAPE  $\blacktriangleleft\blacktriangleright$ .

- Each time you press the button, the tape direction changes as follows:

- $\text{|||||}$ : Plays the front side (left to right).
- $\text{|||||}$ : Plays the reverse side (right to left).

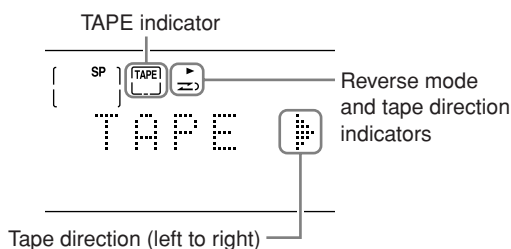

When the tape plays to the end, the deck automatically stops if the reverse mode is set to  $\text{|||}$  or  $\text{|||}$ . (See "To play both sides—Reverse mode" in the right column.)

To stop during play, press  $\blacksquare$ .

To fast-wind to the left, press  $\blacktriangleleft\blacktriangleleft$ .

To fast-wind to the right, press  $\blacktriangleright\blacktriangleright$ .

To remove the cassette, push  $\triangle$  (PUSH OPEN).



DO NOT push  $\triangle$  (PUSH OPEN) during tape play.

### To play both sides—Reverse mode

You can set the deck to play just one side or both sides of a tape once, or both sides continuously.

Press REV. MODE.

- Each time you press the button, the reverse mode changes as follows:



- $\text{|||}$ : Plays back only one side (front or reverse).
- $\text{|||}$ : Plays back the front and reverse sides once.
- $\text{(|||)}$ : Plays back both front and reverse sides continuously.



- The use of the C-120 or thinner tape is not recommended, since characteristic deterioration may occur and this tape easily jams in the pinch rollers and the capstans.
- You can also play back type II and type IV tapes; however, the sound quality (tone) may not be reproduced properly.

# Special Disc Playback

The buttons emphasized in the illustration below are used and explained in the following section (pages 50 to 55).

    shows the types of discs the operation is available for.

- The functions in this section do not work for MP3 discs.

## Remote control

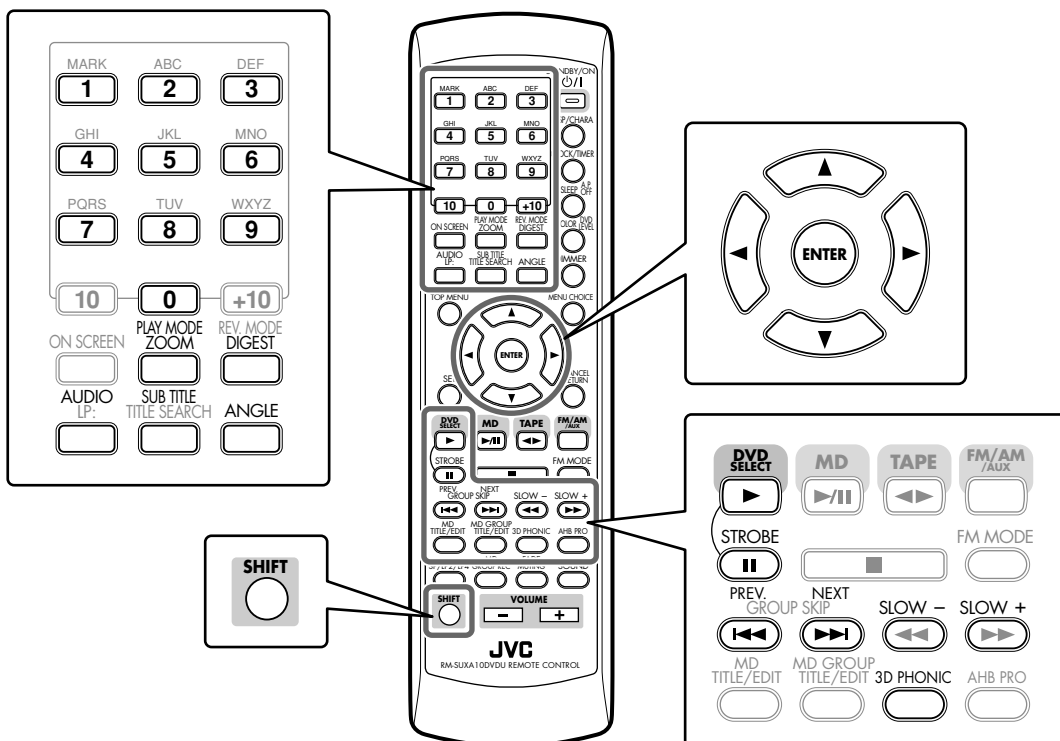

## Main unit

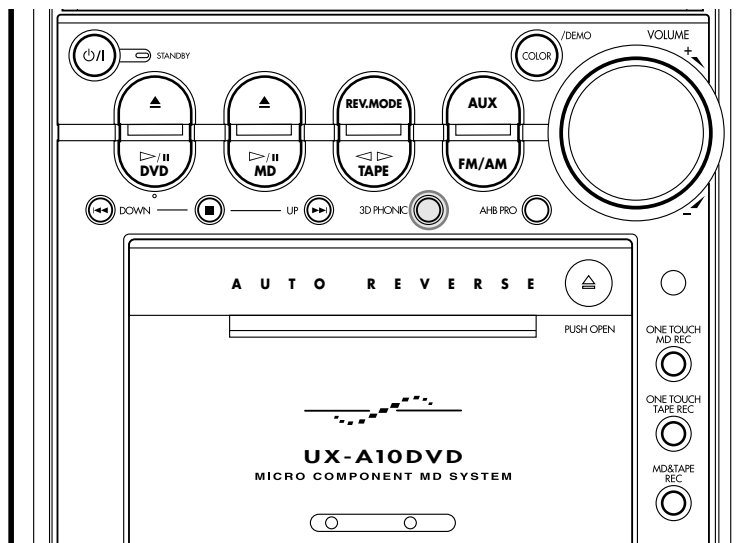

**IMPORTANT:**

Before performing any operations for DVD, SVCD and VCD, make sure of the following.

- Check the connection with the TV.
- Turn on the TV and select the correct input on the TV to view the pictures or on-screen menus/indications on the TV screen.
- Select the correct color system.

## Locating a Scene by Selecting the Chapter Number—Chapter Search

Available for:  DVD

If the current title is divided into chapters, you can skip to the chapter you want by selecting the chapter number.

- You cannot perform this function while the program or the random play is activated.

### On the remote control ONLY:

#### 1 Press PLAY MODE during play.

The play mode screen appears on the TV.

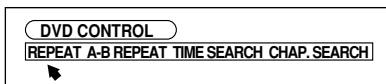

#### 2 Press Cursor ▶/◀ to move to “CHAP. SEARCH,” then press ENTER.

“GO TO CHAPTER =” appears on the TV.

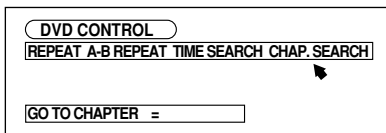

- The chapter search indication appears and the SEARCH indicator also lights up on the display.

#### 3 Enter a chapter number by pressing the number buttons (0 to 9).

- The 10 button works to enter “0.”

Ex.: To enter chapter number 3, press 3.

To enter chapter number 23, press 2 and 3.

To cancel misentry, repeat step 3 until the correct number appears after “=”.

#### 4 Press ENTER.

Playback starts from the beginning of the selected chapter.

To erase the on-screen indication, press PLAY MODE again.

## Locating a Position by Selecting the Playing Time—Time Search

Available for:  DVD  SVCD  VCD  Audio CD

You can play a disc from the position you want by specifying the elapsed time from the beginning of the current title or track.

- You cannot use this function while a SVCD or VCD is played back with the PBC function.
- You cannot use this function for some DVDs without time information.
- You cannot perform this function while the program or the random play is activated.

### On the remote control ONLY:

#### 1 Press PLAY MODE during play.

The play mode screen appears on the TV.

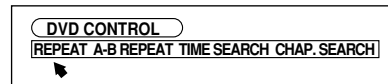

#### 2 Press Cursor ▶/◀ to move to “TIME SEARCH,” then press ENTER.

“GO TO” appears on the TV.

- You can specify the time as follows:
  - For DVD: Hours, minutes, and seconds
  - For SVCD, VCD, or Audio CD: Minutes and seconds

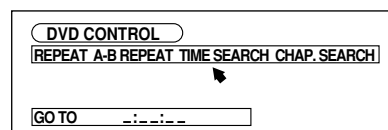

Ex.: While an DVD is played back.

- The time search indication appears and the SEARCH indicator also lights up on the display.

Continued next page ➔

### 3 Enter the playing time by pressing the number buttons (0 to 9).

- The 10 button works to enter “0.”

Ex.: To play back from the position of “0:23:45.”

	_ : _ _ : _ _
Press 0	
↓	0 : _ _ : _ _
Press 2	
↓	0 : 2 _ : _ _
Press 3	
↓	0 : 2 3 : _ _
Press 4	
↓	0 : 2 3 : 4 _
Press 5	
	0 : 2 3 : 4 5

(Always enter all digits.)

**To cancel misentry**, press Cursor ◀.

- Each time you press the button, the last number you entered is erased.

### 4 Press ENTER.

Playback starts from the selected position of the current title or track.

**To erase the on-screen indication**, press PLAY MODE again.

## Viewing the Desired Chapters/Tracks—Digest

Available for:   

You can view nine opening scenes of chapters or tracks at a time and select the desired scene from those displayed on the TV directly.

- You cannot use this function while a SVCD or VCD is played back with the PBC function.
- You cannot perform this function while the program or the random play is activated.

**On the remote control ONLY:**

### 1 Press DIGEST while holding down SHIFT.

The digest screen appear in sequence (up to nine pictures at a time) on the TV.

This scene is selected.



**For DVD:**

- While stopped:  
The opening scenes of each title appear.
- During playback:  
The opening scenes of each chapter in the current title appear.

**For SVCD or VCD:**

The opening scenes of each track appear.

### 2 Press Cursor ◀/▶/▲/▼ to move to a scene you want to start playback.

- If there are more than nine scenes, you can move to the next digest screen (page).

**To show other pages of the digest screen,**

- To show the next page, press NEXT (▶▶).
- To show the previous page, press PREV. (◀◀).

- You can also show other pages as follows:

To show the previous page, press Cursor  $\leftarrow/\blacktriangleright/\blacktriangle/\blacktriangledown$  to select the left top scene, then press Cursor  $\leftarrow$ .



To show the next page, press Cursor  $\blacktriangle/\blacktriangleright/\blacktriangle/\blacktriangledown$  to select the right bottom scene, then press Cursor  $\blacktriangleright$ .

### 3 Press ENTER.

Playback starts with the selected scene.



With some discs

Depending on the contents, it may take some time before all the scenes appear on the TV.

## Selecting Multi-Angle Views

Available for:  DVD

While playing a disc containing multi-angle views, you can view the same scene at different angles.

### To change angle views

On the remote control ONLY:

#### 1 Press ANGLE.

The on-screen indication appears on the TV.



Ex.: When the disc has 3 angle views.

#### 2 Press Cursor $\blacktriangle/\blacktriangleright/\blacktriangle/\blacktriangledown$ to select a view angle you want.

- Each time you press the button, the view angle changes as follows:

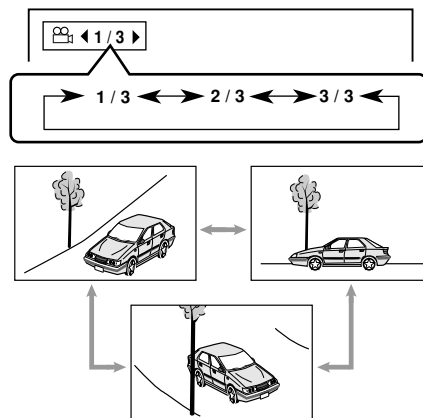

Ex.: When the disc has 3 views.

- You can also select a view angle by pressing ANGLE repeatedly.

To erase the on-screen indication, press ENTER.

### To show all angle views

On the remote control ONLY:

#### 1 Press and hold ANGLE for more than 1 second.

Up to nine pictures of the different camera angles recorded on the disc appear on the TV.

This picture is selected.

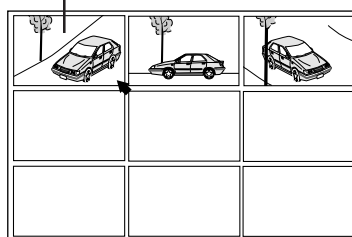

Ex.: When 3 angles are recorded.

#### 2 Press Cursor $\blacktriangle/\blacktriangleright/\blacktriangle/\blacktriangledown$ to move to the desired view.

#### 3 Press ENTER.

The angle list goes off, and playback starts at the selected view angle.



While the angle list is shown on the TV You cannot listen to the sound.

## Selecting the Audio Language or Sound

Available for:  DVD  SVCD  VCD

While playing a disc containing audio languages (sound tracks), you can select the language (sound) to listen to.

### On the remote control ONLY:

#### 1 Press AUDIO.

The on-screen indication appears on the TV.

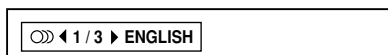

Ex.: While a DVD which has 3 selections is played back.

#### 2 Press Cursor ▶/◀ to select an audio language (sound) you want.

- Each time you press the button, the audio language (sound) changes as follows:

##### For DVD:

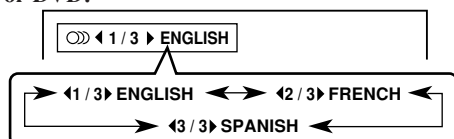

Ex.: When the disc has 3 selections—English, French, and Spanish.

##### For SVCD:

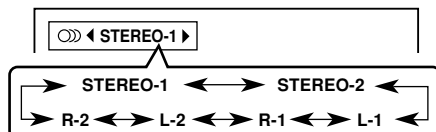

- STEREO-1/STEREO-2:**  
To listen to normal stereo playback of STEREO-1 or 2 channel.
- L-1/L-2:**  
To listen to the L (left) 1 or 2 audio channel.
- R-1/R-2:**  
To listen to the R (right) 1 or 2 audio channel.

##### For VCD:

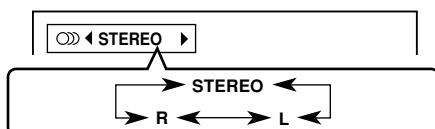

- STEREO:** To listen to normal stereo playback.
- L:** To listen to the L (left) audio channel.
- R:** To listen to the R (right) audio channel.
- You can also select a audio language (sound) by pressing AUDIO repeatedly.

To erase the on-screen indication, press ENTER.



When selecting a language for some DVDs Its abbreviation will be shown. (See page 99.)

## Selecting the Subtitle Language

Available for:  DVD  SVCD

While playing a disc containing subtitles in different languages, you can select the subtitle to be displayed on the TV.

### On the remote control ONLY:

#### 1 Press SUB TITLE.

The on-screen indication appears on the TV.

- Each time you press the button, the subtitle turns on and off.

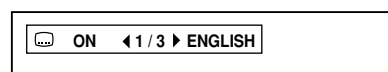

Ex.: While a DVD which has 3 selections is played back.

#### 2 Press Cursor ▶/◀ to select a subtitle language you want.

- Each time you press the button, the subtitle language changes as follows:

##### For DVD:

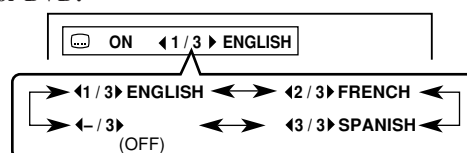

Ex.: When the disc has 3 selections—English, French, Spanish and no subtitle (OFF).

##### For SVCD:

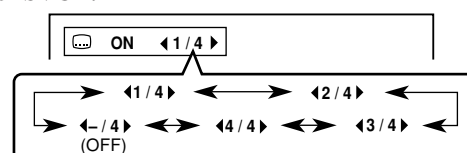

Four subtitle channels shows whether or not any subtitles are actually available.

To show no subtitle, select “-.”

To erase the on-screen indication, press ENTER.



When selecting a language for some DVDs Its abbreviation will be shown. (See page 99.)



## Playing a Still Picture/Frame-by-Frame

Available for:  DVD  SVCD  VCD

You can freeze a picture and advance the still picture frame by frame.

### On the remote control ONLY:

**1** Press **II** once during play.  
A still picture appears on the TV.

**2** Press **II** repeatedly.  
• Each time you press the button, the still picture advances frame by frame.

To go back to normal play, press DVD SELECT ►.

## Showing Continuous Still Pictures—Strobe

Available for:  DVD  SVCD  VCD

You can view the nine continuous still pictures.

### On the remote control ONLY:

**1** Press **STROBE** during play at the point where you want to view continuous still pictures.  
A still picture appears on the TV.

**2** Press and hold **STROBE** for more than 1 second.  
Nine continuous still pictures appear on the TV.  
• Each time you press the button, next nine still pictures appear.

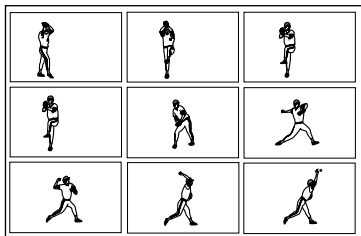

To cancel the strobe play, press and hold **STROBE** so that a still picture resumes, then press DVD SELECT ► to go back to normal play.



Nine screens of the same pictures appear and is played frame-by-frame at normal speed in following cases

- If you press and hold **STROBE** for more than 1 second during normal playback.
- If you press DVD SELECT ► after pressing and holding **STROBE** in step 2.

## Playing Back in Slow-Motion—Slow

Available for:  DVD  SVCD  VCD

You can enjoy the slow-motion playback.

- Reverse slow-motion playback cannot be used on some SVCDs or VCDs.

### On the remote control ONLY:

**1** Press **II** once during play.  
A still picture appears on the TV.

**2** Press **SLOW +** or **SLOW -**.  
• Each time you press **SLOW +**, forward slow-motion speed changes as follows:

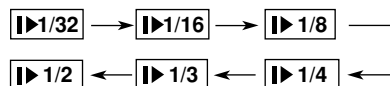

- Each time you press **SLOW -**, reverse slow-motion speed changes as follows:

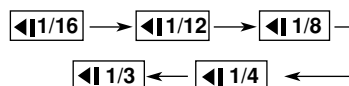

No sound is heard during the slow-motion playback.

To go back to normal play, press DVD SELECT ►.

## Zooming in the Picture—Zoom

Available for:  DVD  SVCD  VCD

You can zoom a picture by 2 times.

### On the remote control ONLY:

#### 1 Press ZOOM while holding down SHIFT.

“ZOOM” appears on the TV.

- Each time you press the buttons, the picture is zoomed in and out alternately.

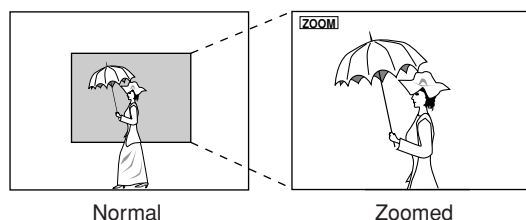

#### 2 Press Cursor /▶/▲/▼ to select the position you want to zoom in.

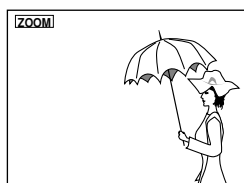

To go back to normal play, press ZOOM while holding down SHIFT.



While zoomed in, the picture may look coarse.

## Enjoying Virtual Surround Sound —3D PHONIC

Available for:  DVD  SVCD  VCD  Audio CD

Using the 3D PHONIC function, you can get a simulated surround effect.

- For SVCD or VCD, you can use the 3D PHONIC function only when the AUDIO setting is set to STEREO. (See page 53.)

### Press 3D PHONIC repeatedly to select the 3D PHONIC mode you want.

- Each time you press the button, the 3D PHONIC mode changes as follows:

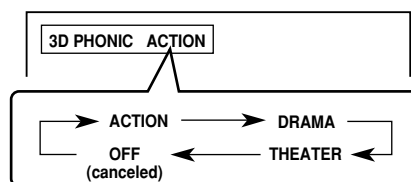

- ACTION\***: Suitable for action movies and sports programs in which sounds dynamically move.
- DRAMA**: Natural and warm sound. You can enjoy movies in a relaxed mood.
- THEATER**: You can enjoy sound effects like in a major theater in Hollywood.

\* When a DVD recorded in Dolby Digital containing more than 3 channels, “ACTION” does not appear.

When the 3D PHONIC function is activated, the 3D PHONIC indicator lights up on the display.

### To erase the on-screen indication, press ENTER.

- If no operation is done for about 5 seconds, the on-screen display goes off.







#### More about the 3D PHONIC function

- The 3D PHONIC function works correctly when playing back discs recorded in the Dolby Surround or Dolby Digital 5.1 ch format. It also works when playing back any discs other than the above, but does not provide the correct effect.
- The 3D PHONIC function does not affect the DTS or Dolby Digital signal from the DVD OPTICAL DIGITAL OUT terminal.
- If a DVD whose sound is recorded in Linear PCM, you cannot use the 3D PHONIC function.
- While you use the 3D PHONIC function, the “DOWN MIX” and “COMPRESSION” settings in the AUDIO menu are deactivated temporarily. (See pages 85 and 86.)
- For SVCD or VCD, when the 3D PHONIC function is active, changing the AUDIO setting cancels the 3D PHONIC function. (See page 53.)

# Recording

The buttons emphasized in the illustration below are used and explained in the following section (pages 57 to 64). For recording operations, you primarily use the buttons on the main unit.

     shows the types of discs the operation is available for.

## Main unit

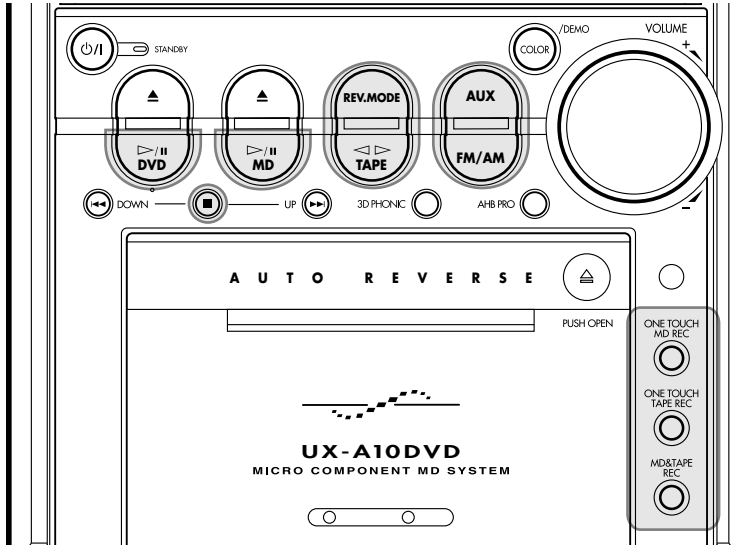

## Remote control

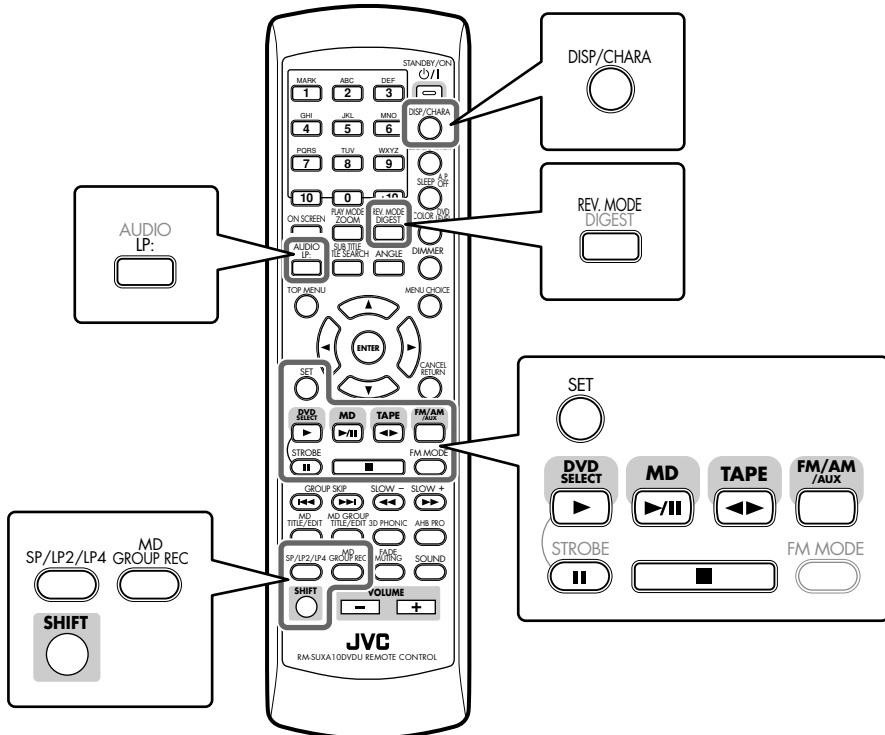

## Before You Start Recording on an MD

- It may be unlawful to record or play back copyrighted material without the consent of the copyright owner.
- When you record onto a partially recorded MD, its contents are not erased or overwritten. The recording starts from the point following the last recorded track of the MD.  
If you want to record on such an MD from the beginning, you have to erase its contents first (see “Erasing All Tracks—ALL ERASE” on page 79).
- When an MD is fully recorded, recording will stop automatically.
- The recording level is automatically set correctly, so it is not affected by the volume level. Thus, during recording you can adjust the sound you are actually listening to without affecting the recording level.
- While recording, you can hear sound mode effect and/or the AHB PRO (Active Hyper Bass Pro) effect through the speakers or headphones. However, the sound is recorded without these effects (see pages 21).
- While recording, the 3D PHONIC function (see page 55) or the COMPRESSION function (see page 86) is activated, the sound is recorded with these effects.
- This unit automatically selects either digital or analog recording according to the playback source.
  - For SVCD, VCD, and Audio CD: Digital recording is used.
  - For DVD and MP3 disc: Analog recording is used.
  - For “AUX-DIGITAL”: Digital recording is used.
  - For other analog sources—“FM,” “AM,” “TAPE,” “AUX”: Analog recording is used.
- You cannot record more than 254 tracks onto an MD, even if there is still enough recording time remaining on it.

### About the track marks

When playing an MD, you can move among the tracks. You can do this because there is a mark recorded at the beginning of each track enabling you to locate the track. This mark is called a “**track mark**” and the portion between two adjacent track marks is called a “**track**.”

- **When using the disc synchronized recording**, a track mark is recorded at the beginning of each chapter and track. You cannot put a track mark on manually.
- **When recording from an analog source**—“FM,” “AM,” “TAPE,” “AUX,” no track mark is recorded on the MD. This means that, when playing this MD, the MD recorder will regard the entire recording as one track (track 1). You will not be able to select directly a song or navigate through songs.

However, if there is a blank of 3 seconds or more, the MD recorder will consider it as a blank separating 2 tracks and consequently put a track mark (except when recording from an FM or AM broadcast).

**To set a track mark manually while recording an analog source**, press SET on the remote control at the place where you want to put a track mark.

**To add a track mark after recording is over**, you can use the DIVIDE function. (See page 76.)

### To avoid erasing important recordings

The recordable MD has an erasure prevention tab so that important recordings are not accidentally erased. When you finish recording or editing, slide to open the erasure prevention tab on the cartridge side. New recording or editing is now no longer possible. (If you try to do, “DISC PROTECTED” appears in the main display.)

To do re-recording or editing, return the tab to the closed position.

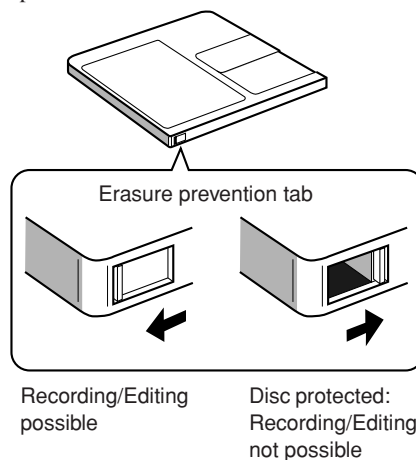

**If “PLAYBACK DISC” appears in the main display when you try to record on an MD**  
The MD is only for playback use, not for recording. (See page 96.)

### Stereo Long-Hour Recording (MDLP)

On conventional MD recorders, 2 times long-hour recording on MDs has been possible only in monaural sound, but this unit allows for 2 times or 4 times long-hour recording without losing stereo sound by the latest ATRAC3\* techniques.

\* See “ATRAC (Adaptive TRansform Acoustic Coding)/ATRAC3 (MDLP)” below.

With this feature, you can record on a single MD using different recording length modes—SP: Standard Play, LP2: 2 Times Long Play, LP4: 4 Times Long Play.

**SP:** Signifies standard-hour stereo recording. The amount of time usable for recording is the same as shown on the package of the MD.

**LP2:** Signifies 2 times long-hour stereo recording. The amount of time usable for recording is twice as long as shown on the package of the MD.

**LP4:** Signifies 4 times long-hour stereo recording. The amount of time usable for recording is 4 times as long as shown on the package of the MD.

#### REMEMBER to check the remaining recording time of MDs before starting recording

The remaining recording time of MDs will be calculated and shown, based on the recording length mode (SP/LP2/LP4) currently selected.

Before starting recording or using the Recording Timer, check the recording time remaining on the MD for each recording length mode (SP/LP2/LP4) and select the optimum recording length mode.

#### To check the remaining recording time

- 1 Load an MD to record on.
  - 2 Select the source to record (except “MD”).
  - 3 Press DISP/CHARA repeatedly until “REC REMAIN” and the remaining time based on the current recording mode\* appear in the main display.
- \* When the source is “MD,” the remaining time will be shown based on SP mode.

#### Precautions for performing long-hour stereo recording

After having made long-hour stereo recordings on this unit, pay attention to the following:

- Songs (tracks) recorded in 2 times or 4 times long-hour recording mode can only be played back on equipment provided with MDLP, compatible with a long-hour stereo recording function; otherwise, “LP:” is displayed before a title and playback proceeds without sound.
- When editing songs (tracks) on an MD, you cannot join (JOIN) songs (tracks) recorded in different recording length modes (SP/LP2/LP4).



#### More about MDLP

- You cannot make a long-hour monaural recording using this unit.
- Sound quality will decrease as the recording length mode changes to LP2 (little) and LP4 (much). To obtain the best sound quality, it is recommended to use the SP mode when recording.

### SCMS (Serial Copy Management System)

The MD recorder integrated to this unit uses the Serial Copy Management System which allows only first-generation digital copies to be made of premastered software (like CDs or prerecorded MDs).

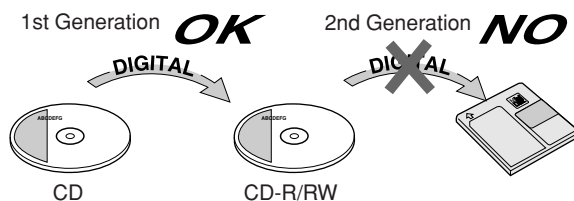

### ATRAC (Adaptive TRansform Acoustic Coding)/ATRAC3 (MDLP)

The MD provides 80 minute recording and playback time, much more than an audio CD, but in a diameter of only 64 mm. This ability to store such a large amount of data is the result of ATRAC, an audio compression technique developed for MD. This technology cuts out faint sounds that would not be heard by the human beings. This technology, based on human sensitivity to sounds, reduces recorded data volume up to about one-fifth of the original data volume.

Furthermore, this unit takes advantage of the latest ATRAC3 techniques, which can reduce the amount of data to record to one-tenth or one-twentieth of the original data volume. This allows for 2 times or 4 times long-hour stereo recording on this unit.

## Setting MD Recording Modes

Before recording on MDs, set the recording length mode (SP/LP2/LP4), “LP:”-prefix addition mode, and the group recording mode.

### On the remote control ONLY:

#### To set the MD recording length mode

The MD recording length mode can be set and stored for each source.

##### 1) Select the source to record.

##### 2) Press SP/LP2/LP4.

- Each time you press the button, the recording length mode changes to “SP,” “LP2,” “LP4.”
  - SP:** Records using standard-hour stereo recording. The SP indicator lights up on the display.
  - LP2:** Records using 2 times long-hour stereo recording. The LP2 indicator lights up on the display.
  - LP4:** Records using 4 times long-hour stereo recording. The LP4 indicator lights up on the display.

#### To set “LP:”-prefix addition mode

You can select whether or not to add “LP:” to the head of the title for the tracks recorded using the stereo long-hour recording mode (LP2 or LP4).

##### Press LP: while holding down SHIFT.

- Each time you press the buttons, the “LP:”-prefix addition mode turns on and off.
  - “(LP:) ON”:** Adds “LP:” to the head of the track title. The total number of characters you can enter for an MD is reduced (for details, see page 80).
  - “(LP:) OFF”:** Does not add “LP:” to the head of the track title.

#### To set the group recording mode

You can form a new group easily while recording using the group recording function.

##### Press MD GROUP REC.

- Each time you press the button, the group recording function turns on and off.
  - “MD GROUP ON”:** All the tracks recorded at a time will form a new group. The GROUP indicator lights up on the display.
  - “MD GROUP OFF”:** Cancels the group recording function. All tracks are recorded as independent tracks. The GROUP indicator goes off from the display.

## Recording a Disc onto an MD—Disc Synchronized Recording

Using the disc synchronized recording method, you can start and stop disc play and MD recording at the same time.

- During the disc synchronized recording, some operations which would affect the recording (both audio and video) are prohibited.

### ■ From an SVCD, VCD, Audio CD, or MP3 disc

Available for:  SVCD  VCD  Audio CD  MP3

- Digital recording method is used for SVCD/VCD/Audio CD-to-MD recording, while analog recording method is used for MP3 disc-to-MD recording.

#### 1 Prepare a disc.

After placing a disc, press DVD ▷/|| (or DVD SELECT ► on the remote control), then ■ before going to the next step.

- You can create a program (see page 37) or select the random play mode (see page 39) as you wish.

#### 2 Insert a recordable MD into the MD loading slot.

#### 3 Set the MD recording length mode, “LP:”-prefix addition mode, and the group recording mode.

See the left column.

#### 4 Press ONE TOUCH MD REC on the main unit.

Recording starts and the MD REC indicator starts flashing on the display.

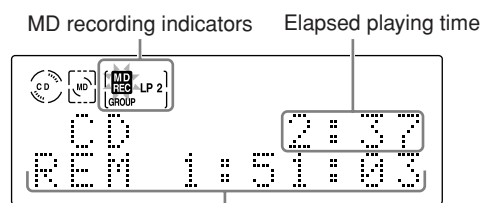

Remaining recording time

Ex.: An audio CD is now recorded on an MD using LP2 and the group recording.

After recording, both the DVD player and the MD recorder stop automatically.

To stop recording, press ■.

“WRITING” flashes in the main display for a while.



#### When recording from a CD-R or CD-RW

You cannot make a digital recording from a digital-copied CD-R or CD-RW on an MD. “SCMS CANNOT COPY” appears in the main display and an analog recording starts. (See page 58.)

## ■ From a DVD

Available for: DVD

- Analog recording method is used for DVD-to-MD recording.

### 1 Prepare a disc.

After placing a disc, press DVD ▷/|| (or DVD SELECT ► on the remote control), then ■ before going to the next step.

- You can create a program (see page 37) or select the random play mode (see page 39) as you wish.

### 2 Insert a recordable MD into the MD loading slot.

### 3 Set the MD recording length mode, “LP:”-prefix addition mode, and the group recording mode. See “Setting MD Recording Modes” on page 59.

### 4 Press ONE TOUCH MD REC on the main unit.

Recording starts and the MD REC indicator starts flashing on the display.

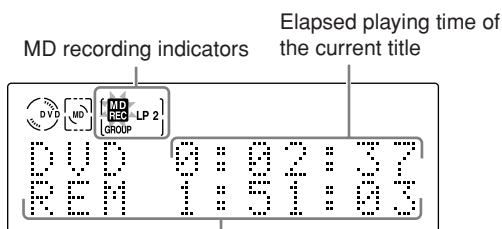

Remaining recording time

Ex.: A DVD is now recorded on an MD using LP2 and the group recording.

After recording, both the DVD player and the MD recorder stop automatically.

To stop recording, press ■.

“WRITING” flashes in the main display for a while.



**When recording from some DVDs which have its menu**

Playback may not go further from the point where the menu is shown. (You cannot select any item on the menu during recording.) In such a case, stop the recording and select the point where you want to start recording as follows:

- 1 Start disc playback.
- 2 Select the item on the disc menu which you want to record. The selected item starts playback.
- 3 Press || where you want to start recording.
- 4 Press ONE TOUCH MD REC to start recording.

## To record a single track during play or pause

Available for: SVCD VCD Audio CD

- You can do this operation for SVCD or VCD only without the PBC function.

### On the main unit ONLY:

**While playing back or pausing a track you want to record, press ONE TOUCH MD REC.**

The playback of the track is stopped, and the same track starts playing from the beginning again. This time, the MD recorder starts recording the track.

- After the track is recorded, both the DVD player and the MD recorder stop automatically.



**If you do the above operation for a DVD or an MP3 disc**

Recording starts from the point where you press the button and does not stop after the current chapter or track is recorded. (Playback also continues.)

## To change the information shown in the main display

### On the remote control ONLY:

Press DISP/CHARA.

- Each time you press the button, the information in the main display changes as follows:

For SVCD, VCD, or Audio CD:

Ex.: When recording an Audio CD.

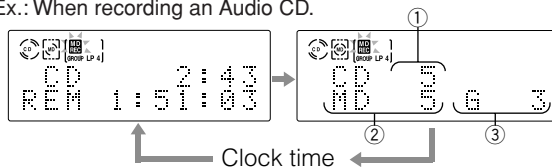

For MP3 disc:

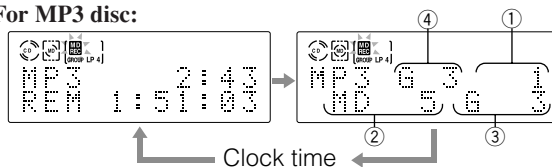

For DVD:

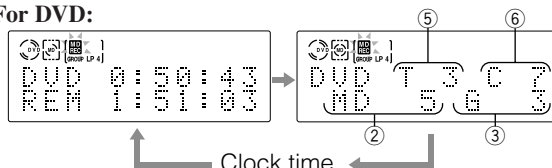

- |                     |                       |
|---------------------|-----------------------|
| ① Current track No. | ④ Current group No.   |
| ② MD track No.      | ⑤ Current title No.   |
| ③ MD group No.*     | ⑥ Current chapter No. |

\*When recording on the MD which has no group and when the group recording is not activated, “- -” will appear.

## Recording Other Sources onto an MD

- Digital recording method is used for AUX-DIGITAL-to-MD recording, while analog recording method is used for FM/AM/AUX-to-MD recording.

### Sound synchronized recording

When recording from external equipment, recording starts automatically when the source sound comes into the unit, and stops automatically if no sound comes into the unit for more than 30 seconds.

## 1 Prepare the source to record.

### To record from FM/AM broadcasts:

Press FM/AM (or FM/AM/AUX on the remote control) to select either “FM” or “AM,” then tune in to the station you want.

- For more detailed tuner operations, see pages 25 and 26.

### To record from a tape:

- 1) After putting a cassette, press TAPE ◀▶, then ■ to select “TAPE” as the source.
- 2) Press REV. MODE to select the reverse mode (see page 48).

### To record from external equipment:

Press AUX (or FM/AM/AUX on the remote control) repeatedly to select “AUX” or “AUX-DIGITAL” and prepare the external equipment.

- Adjust audio input level through the AUX jacks or the OPTICAL DIGITAL IN terminal if necessary (see page 23).
- For operation of the external equipment, see its manual also.

## 2 Insert a recordable MD into the MD loading slot.

## 3 Set the MD recording length mode, “LP:”-prefix addition mode, and the group recording mode. See “Setting MD Recording Modes” on page 59.

## 4 Press ONE TOUCH MD REC on the main unit.

- When recording from an FM/AM broadcast or a tape, recording starts and the MD REC indicator starts flashing on the display.
- When recording from external equipment, the following indication appears in the main display.
  - When “AUX” is selected: “AUX → MD”
  - When “AUX-DIGITAL” is selected: “AUX-D → MD”

MD and MD REC indicator are flashing.

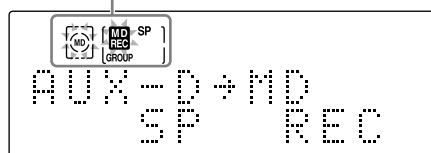

Ex.: When recording from “AUX-DIGITAL” using the group recording.

## When recording from external equipment, go to step 5.

## 5 Starts playback on external equipment.

When the sound from external equipment comes into the unit, recording starts.

To set a track mark manually while recording, press SET on the remote control at the place where you want.



When “AUX-DIGITAL” is the source to record  
You cannot set a track mark manually while recording.

To stop recording, press ■.

“WRITING” flashes in the main display for a while.

## To change the information shown in the main display

### On the remote control ONLY:

Press DISP/CHARA.

- Each time you press the button, the information in the main display changes as follows:

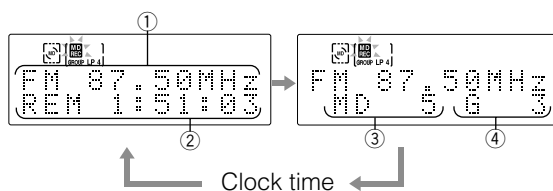

Ex.: When you record an FM broadcast.

- ① Source indication
- ② Remaining recording time
- ③ MD track No.
- ④ MD group No. (When the group recording is not activated, “-” will appear.)



## Before You Start Recording on a Tape

- It may be unlawful to record or play back copyrighted material without the consent of the copyright owner.
- The recording level is automatically set correctly, so it is not affected by the volume level. Thus, during recording you can adjust the sound you are actually listening to without affecting the recording level.
- While recording, you can hear sound mode effect and/or the AHB PRO (Active Hyper Bass Pro) effect through the speakers or headphones. However, the sound is recorded without these effects (see pages 21).
- While recording, the 3D PHONIC function (see page 55) or the COMPRESSION function (see page 86) is activated, the sound is recorded with these effects.
- If recordings you have made have excessive noise or static, the unit may be too close to a TV. Place the unit away from the TV.
- You can use only type I tapes for recording.

### To protect your recordings

Cassettes have two small tabs on the back to protect against unexpected erasure or recording.

To protect your recording, remove these tabs.

To re-record on a protected tape, cover the holes with adhesive tape.

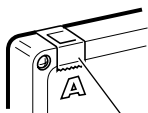

Adhesive tape



Do not use type II and type IV tapes since the unit is not compatible with such tapes.



The use of the C-120 or thinner tape is not recommended, since characteristic deterioration may occur and this tape easily jams in the pinch rollers and the capstans.

### To keep the best recording and playback sound quality

If the heads, capstans, and pinch rollers of the cassette deck become dirty, the following will occur:

- Loss of sound quality
- Discontinuous sound
- Fading
- Incomplete erasure
- Difficulty in recording

### To clean the heads, capstans, and pinch rollers

Use a cotton swab moistened with alcohol.

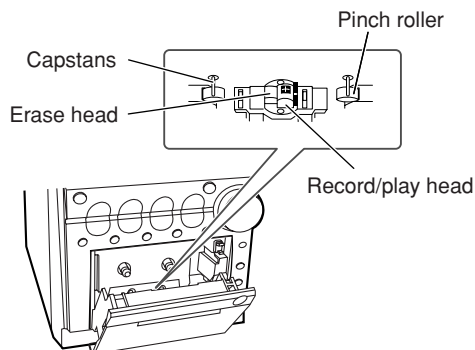

### To demagnetize the head

Turn off the unit, and use a head demagnetizer (available at electronics and audio shops).



### At the start and end of cassette tapes

There is leader tape which cannot be recorded onto. Thus, when recording discs, MDs, or radio broadcasts, wind the leader tape first to ensure that the recording will be made without any music part lost.

## Recording onto a Tape

You can use only type I tapes for recording.

### 1 Prepare the source to record.

#### To record from a disc:

- 1) Load a disc.
  - 2) Press DVD ▷/|| (or DVD SELECT ► on the remote control), then ■ before going to the next step.
- You can create a program (see page 37) or select the random play mode (see page 39) as you wish.

#### To record from an MD:

- 1) Load an MD.
  - 2) Press MD ▷/||, then ■ to change the source to "MD."
- You can create a program (see page 43) or select the random play mode (see page 44) or the group play mode (see page 45) as you wish.

#### To record from FM/AM broadcasts:

Press FM/AM (or FM/AM/AUX on the remote control) to select either "FM" or "AM," then tune in to the station you want.

- For more detailed tuner operations, see pages 25 and 26.

#### To record from external equipment:

Press AUX (or FM/AM/AUX on the remote control) repeatedly to select "AUX" or "AUX-DIGITAL" and prepare the external equipment.

- Adjust audio input level through the AUX jacks or the OPTICAL DIGITAL IN terminal if necessary. (See page 23.)
- For operation of external equipment, see its manual also.

### 2 Put a recordable cassette into the cassette holder.

### 3 Press REV. MODE to select the reverse mode.

- Each time you press the button, the reverse mode changes as follows:

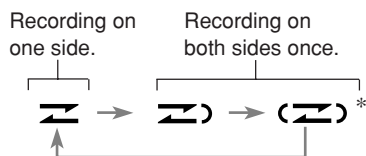

- \* will be shown during recording when you select \*.

### 4 Press ONE TOUCH TAPE REC on the main unit.

Recording starts and the REC indicator starts flashing on the display.

- When recording from external equipment, start playback after the following indication appears in the main display.

–When "AUX" is selected: "AUX → TAPE"

–When "AUX-DIGITAL" is selected:  
"AUX-D → TAPE"

To stop recording, press ■.



**notes** When recording a disc (except DVD and MP3 disc), or an MD

- A 4-second blank is automatically made on the tape before each track. To record without the blank, press DVD ▷/|| or MD ▷/|| twice in step 1, then press ONE TOUCH TAPE REC.
- When the front side of the tape ends in the middle of a track, the recording on the reverse side starts from the beginning of that track (if the reverse mode is set to ). However, if the front side ends within 12 seconds from the beginning of a track, recording on the reverse side starts from the previous track.



**notes** When recording from some DVDs which have its menu

Playback may not go further from the point where the menu is shown. (You cannot select any item on the menu during recording.) In such a case, stop the recording and select the point where you want to start recording. (See page 60.)

### To record a single track during play

- This operation is available for SVCD and VCD without the PBC function, Audio CD, and MD.

#### On the main unit ONLY:

**While playing back a track you want to record, press ONE TOUCH TAPE REC.**

The playback of the track is stopped, and the same track starts playing from the beginning again. This time, the cassette deck starts recording the track.

- After the track is recorded, both playback and recording stop automatically.



**notes** When you press ONE TOUCH TAPE REC while pausing a track

Recording starts from that point.



**notes** If you do the above operation for a DVD or an MP3 disc

Recording starts from the point where you press the button and does not stop after the current chapter or track is recorded. (Playback also continues.)

## Recording a Disc onto an MD and a Tape —Disc Synchronized Recording

Available for:  DVD  SVCD  VCD  Audio CD  MP3

Using the disc synchronized recording method, you can start and stop disc play, MD and tape recordings at the same time.

### 1 Prepare a disc.

After placing a disc, press DVD ▷/|| (or DVD SELECT ► on the remote control), then ■ before going to the next step.

- You can create a program (see page 37) or select the random play mode (see page 39) as you wish.

### 2 Insert a recordable MD into the MD loading slot and put a recordable cassette into the cassette holder.

#### For the MD:

Set the MD recording length mode, “LP:”-prefix addition mode, and the group recording mode. (See “Setting MD Recording Modes” on page 59.)

#### For the tape:

Press REV. MODE to select the reverse mode (◀▶). (See page 63.)

### 3 Press MD&TAPE REC on the main unit.

Recording start and the MD REC and REC indicators start flashing on the display.

MD and tape recording indicators

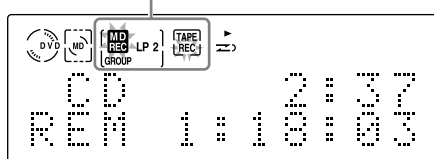

After recording, the DVD player, the MD recorder and the cassette deck stop automatically.

To stop recording, press ■.

“WRITING” flashes in the main display for a while.



**When recording on an MD and a tape at the same time**

A 4-second blank before each track is not made on the tape.



**When recording from some DVDs which have its menu**

Playback may not go further from the point where the menu is shown. (You cannot select any item on the menu during recording.) In such a case, stop the recording and select the point where you want to start recording. (See page 60.)

### To record a single track during play or pause

Available for:  SVCD  VCD  Audio CD

- You can do this operation for SVCD or VCD only without the PBC function.

#### On the main unit ONLY:

**While playing back or pausing a track you want to record, press MD&TAPE REC.**

The playback of the track is stopped, and the same track starts playing from the beginning again. This time, the MD recorder and cassette deck start recording the track.

- After the track is recorded, both playback and recording stop automatically.



**If you do the above operation for a DVD or an MP3 disc**

Recording starts from the point where you press the button and does not stop after the current chapter or track is recorded. (Playback also continues.)

# Editing MDs

The buttons emphasized in the illustration below are used and explained in the following section (pages 66 to 82).

## Remote control

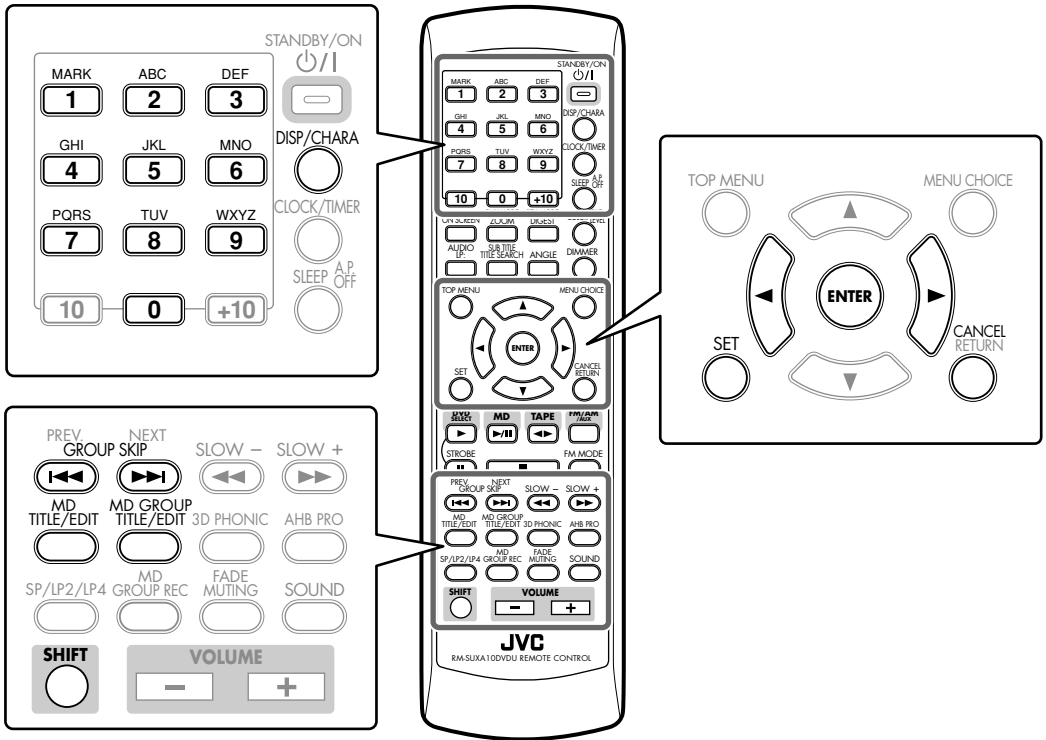

## Main unit

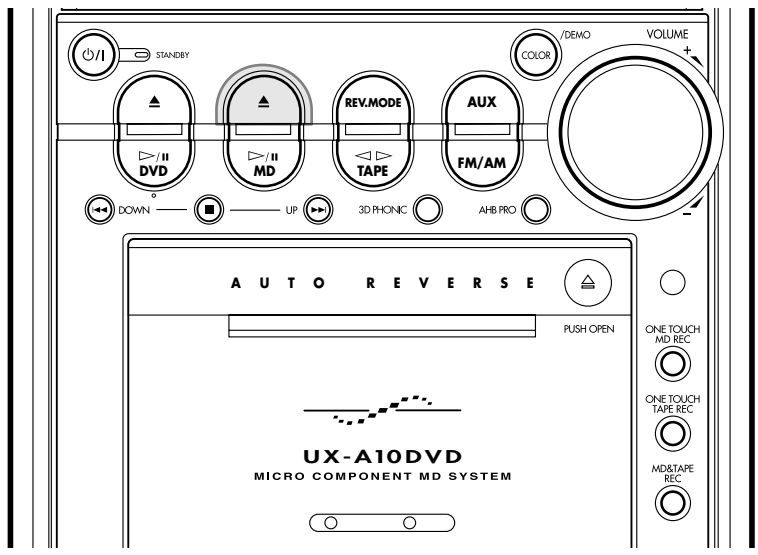

## Guidance—MD Group Functions

To add to the conventional MD editing functions (called the track editing functions in this manual), MD group functions help you to classify the tracks by making groups on your MD.

### Classifying the tracks on an MD

MDLP enables you to record more tracks on a single MD than the conventional recording method. So, there are many tracks which have been recorded from the various sources—discs, FM, and so on—on your MD.

In that case, if you can classify the tracks by source, by album, or by artist, the playback of your favorite songs becomes much easier.

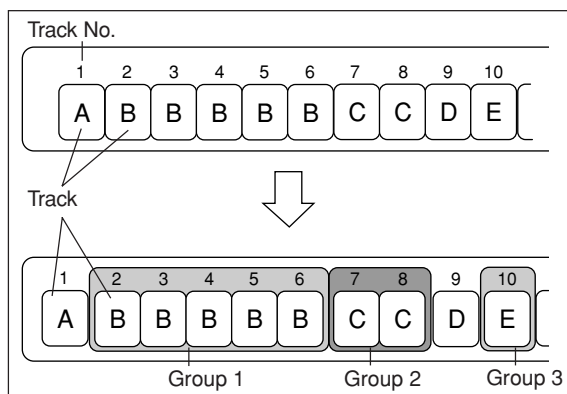

In the figure above, as an example, there are 5 different genres (from A to E) of tracks on the MD. Using MD group functions, you can form a group by genre B tracks as Group 1.

By forming groups on the MD, you can classify the tracks by each genre—the album title, the artist, etc. You can also assign a name to each group. (See pages 80 to 82.)

### Using MD group functions

MD group functions consist of group play, group recording and group editing.

- **Group play (see page 45):**

You can play back and repeat the desired group without making a program: For example, you can play back genre B tracks continuously by selecting group 1 in the left figure.

- **Group recording (see page 59):**

You can form a group while tracks are being recorded.

- **Group editing:**

You can edit the groups using the following functions:

- Forming a group (FORM GR)
- Adding a track to a group (ENTRY GR)
- Dividing a group (DIVIDE GR)
- Joining two groups (JOIN GR)
- Moving a group (MOVE GR)
- Ungrouping tracks (UNGROUP)
- Dissolving all groups (UNGR ALL)
- Erasing tracks in a group (ERASE GR)

### How to make up groups

You can make up groups using two methods: the forming-a-group function and the group recording function.

- **Forming-a-group function—FORM GR:**

Select this function when you want to make groups after recording. (See page 68.)

- **Group recording function:**

Select this function when you want to record and group tracks at the same time. (See page 59.)



#### About information concerning MD group functions

Once you edit an MD using MD group functions, the MD is assigned some characters as the information concerning MD group functions. These characters appear only when you play back the MD using the equipment incompatible with MD group functions. If you edit the characters using such equipment, the groups on the MD will be dissolved.

## Introducing Group Editing Functions

The groups and tracks can be edited in many ways (the group editing functions and the track editing functions). From this page to page 74, the group editing functions are explained. For details of the track editing functions, see pages 75 to 79.

### Forming a group (FORM GR): Page 68

This function forms a series of tracks or a single track into a new group.

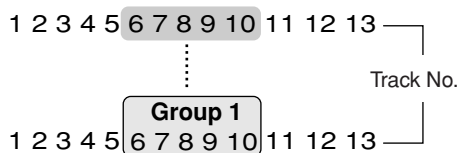

### Adding a track to a group (ENTRY GR): Page 69

This function enters the selected track into a group.

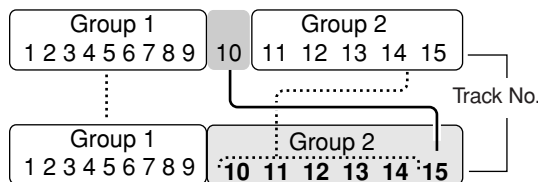

### Dividing a group (DIVIDE GR): Page 70

This function divides a group containing more than one track.

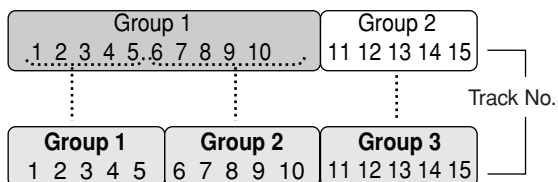

### Joining two groups (JOIN GR): Page 71

This function joins two adjacent groups into a single group.

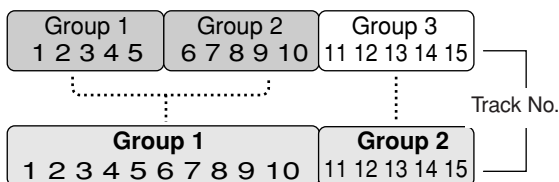

### Moving a group (MOVE GR): Page 72

This function moves the selected group by reordering the group and track numbers.

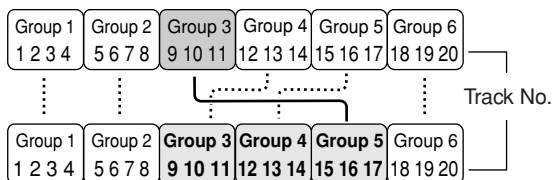

### Ungrouping tracks (UNGROUP): Page 73

This function dissolves a group.

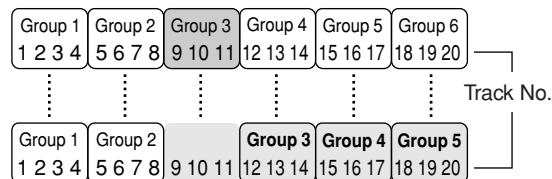

### Dissolving all groups (UNGR ALL): Page 73

This function dissolves all the groups.

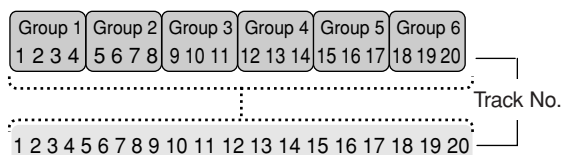

### Erasing tracks in a group (ERASE GR): Page 74

This function erases the tracks in the selected group.

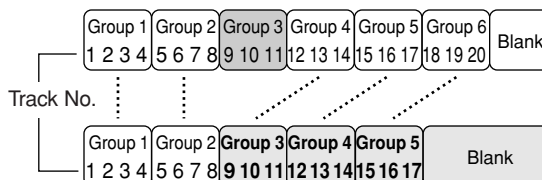

If "PLAYBACK DISC" or "DISC PROTECTED" appears when you try to edit an MD  
You cannot edit such MDs. (See pages 95 and 96.)



During the program or random play mode  
You can edit the MD as long as playback is stopped. However, editing groups and/or tracks will restore normal play mode (the program in memory will be cleared).

## Forming a Group—FORM GR

This function allows you to form a group from a series of tracks which do not belong to other groups. You can form a group with a single track.

Once a new group is formed, the other groups are renumbered.

- You can form up to 99 groups on a single MD.
- To stop any time during the editing process before step 8, press MD GROUP TITLE/EDIT.

### On the remote control ONLY:

In the following example, the process is explained from the very beginning—that is, inserting a disc. You can also edit an MD during playback (in normal play mode).

**1** Insert an MD you want to edit into the MD loading slot.

**2** Press MD GROUP TITLE/EDIT repeatedly until “FORM GR ?” appears in the main display.

FORM GR ?  
YES? → SET

- If you want to stop this editing process, press CANCEL.

**3** Press SET.

Track Nos. to form a new group

FORM GR ?  
YES? → SET

- **During playback:**  
The currently playing track number starts flashing.

**4** Press ►► or ◀◀ to select the first track of a new group you will make.

- You can select the track using the number buttons. In this case, the selected track starts playback repeatedly.

FORM GR ?  
YES? → SET

Ex.: When track 3 is selected.

**5** Press SET.

- If the track selected belongs to another group, “GROUP TRACK” appears in the main display. Select a track which do not belong to another group in step 4 again.
- If you want to form a group with the selected track only, go to step 7.
- To cancel the setting, press CANCEL, then repeat from step 4.

**6** Press ►► or ◀◀ to select the last track of the new group.

- You can select the track using the number buttons. In this case, the selected track starts playback repeatedly.

FORM GR ?  
YES? → SET

Ex.: When track 5 is selected.

**7** Press SET.

<FORM GR>  
YES? → ENTER

- If the track selected belongs to another group, “GROUP TRACK” appears in the main display. Select a track which do not belong to another group in step 6 again.
- To cancel the setting, press CANCEL, then repeat from step 4.

**8** Press ENTER.

- “EDITING” appears in the main display for a while, then “WRITING” and the MD REC indicator flashes while the changes you have made are recorded on the MD.

To dissolve the group again, see the UNGROUP function on page 73.



### When “CANNOT FORM!” appears in step 7

You are trying to form a new group which includes another group between the first and the last track. In this case, dissolve the previous group and form a new one again.

## Adding a Track to a Group—ENTRY GR

This function allows you to enter a track into a group. The track will be added as the last track in the selected group. The track numbers will be renumbered.

- To stop any time during the editing process before step **8**, press MD GROUP TITLE/EDIT.

### On the remote control ONLY:

In the following example, the process is explained from the very beginning—that is, inserting a disc. You can also edit an MD during playback (in normal play mode).

**1** Insert an MD you want to edit into the MD loading slot.

**2** Press MD GROUP TITLE/EDIT repeatedly until “ENTRY GR ?” appears in the main display.

ENTRY GR  
YES? → SET

- If you want to stop this editing process, press CANCEL.

**3** Press SET.

Track No.  
TR 1  
OK? → SET

- **During playback:**  
The currently playing track number starts flashing.

**4** Press ►► or ◀◀ to select the track.

- You can select the track using the number buttons. In this case, the selected track starts playback repeatedly.

TR 13  
OK? → SET

Ex.: When track 13 is selected.

**5** Press SET.

GROUP 1  
OK? → SET

- If the loaded MD has no groups, you cannot go on to the following steps.
- When the selected track belongs to a group, its group number appears in the main display.
- To cancel the setting, press CANCEL, then repeat from step **4**.

**6** Press GROUP SKIP ►► or GROUP SKIP ◀◀ while holding down SHIFT to select the group.

GROUP 18  
OK? → SET

Ex.: When group 18 is selected.

**7** Press SET.

<ENTRY GR>  
YES? → ENTER

- To cancel the setting, press CANCEL, then repeat from step **4**.

**8** Press ENTER.

“EDITING” appears in the main display for a while, then “WRITING” and the MD REC indicator flashes while the changes you have made are recorded on the MD.



**When “CANNOT ENTRY!” appears in step 7**  
You are trying to enter the selected track into the same group again. Repeat procedure from step **6**.



## Dividing a Group—DIVIDE GR

This function allows you to divide one group into two separate groups.

You cannot divide a group containing only a single track. When the original group has a title, both new groups are reassigned the same title as the original group. Once a new group is divided, the other groups are renumbered.

- To stop any time during the editing process before step 7, press MD GROUP TITLE/EDIT.

### On the remote control ONLY:

In the following example, the process is explained from the very beginning—that is, inserting a disc. You can also edit an MD during playback (in normal play mode).

**1** Insert an MD you want to edit into the MD loading slot.

**2** Press MD GROUP TITLE/EDIT repeatedly until “DIVIDE GR?” appears in the main display.

DIVIDE GR?  
YES? → SET

- If you want to stop this editing process, press CANCEL.

**3** Press SET.

Group No.                      Track No.  
G 1 2 T 1  
OK? → SET

- If the loaded MD has no groups, you cannot go on to the following steps.
- During playback:**  
The currently playing track number and its group number will appear. If the track does not belong to any group, the group number will be indicated by “--”

**4** Press GROUP SKIP ►► or GROUP SKIP ◄◄ while holding down SHIFT to select the group you want to divide.

G 2 T 5  
OK? → SET

The first track of the selected group

Ex.: When group 2 is selected.

**5** Press ►► or ◄◄ to select the track as the dividing point.

The track selected in this step will be the first track in the divided group.

- You can select the track using the number buttons. In this case, the selected track starts playback repeatedly.

G 2 T 5  
OK? → SET

Ex.: When track 8 is selected.

- You cannot select the first track in a group or an ungrouped track as the dividing point.

**6** Press SET.

< DIVIDE GR >  
YES? → ENTER

- To cancel the setting, press CANCEL, then repeat from step 4.

**7** Press ENTER.

“EDITING” appears in the main display for a while, then “WRITING” and the MD REC indicator flashes while the changes you have made are recorded on the MD.

To join the divided groups again, see the JOIN GR function on page 71.

## Joining Two Groups—JOIN GR

This function allows you to join two adjacent groups into a single group.

When the groups have their own titles, the title of the preceding group is reassigned to the joined group. Once two groups are joined, the other groups are renumbered.

- To stop any time during the editing process before step 6, press MD GROUP TITLE/EDIT.

### On the remote control ONLY:

In the following example, the process is explained from the very beginning—that is, inserting a disc. You can also edit an MD during playback (in normal play mode).

**1** Insert an MD you want to edit into the MD loading slot.

**2** Press MD GROUP TITLE/EDIT repeatedly until “JOIN GR ?” appears in the main display.

JOIN GR ?  
YES? → SET

- If you want to stop this editing process, press CANCEL.

**3** Press SET.

Group Nos. to be joined

G → — + G → 1 ?  
OK? → SET

- If the loaded MD has only one or no groups, you cannot go on to the following steps.
- During playback:** The group number of the currently playing track will appear on the right. If the track does not belong to any group, the group number will be indicated by “—.”

**4** Press GROUP SKIP ►► or GROUP SKIP ◀◀ while holding down SHIFT to select the two adjacent groups you want to join.

G → 7 + G → 8 ?  
OK? → SET

Ex.: When groups 7 and 8 are selected.

**5** Press SET.

< JOIN GR >  
YES? → ENTER

- To cancel the setting, press CANCEL, then repeat from step 4.

**6** Press ENTER.

“EDITING” appears in the main display for a while, then “WRITING” and the MD REC indicator flashes while the changes you have made are recorded on the MD.

To divide the group again, see the DIVIDE GR function on page 70.



When “CANNOT JOIN” appears in step 5

You are trying to join two groups which are separated by one or more tracks. In such a case, move the tracks or one of the groups so that the groups are adjacent. (See pages 72 and 78.)

## Moving a Group—MOVE GR

This function allows you to move a group.

Once a group is moved, the tracks and the other groups are renumbered.

- To stop any time during the editing process before step **8**, press MD GROUP TITLE/EDIT.

### On the remote control ONLY:

In the following example, the process is explained from the very beginning—that is, inserting a disc. You can also edit an MD during playback (in normal play mode).

- 1 Insert an MD you want to edit into the MD loading slot.

- 2 Press MD GROUP TITLE/EDIT repeatedly until “MOVE GR ?” appears in the main display.

MOVE GR  
YES? SET

- If you want to stop this editing process, press CANCEL.

- 3 Press SET.

Group No. to be moved to      Group No. to be moved from

G      +G      10?      3?

OK? SET

- If the loaded MD has only one or no groups, you cannot go on to the following steps.
- During playback:**  
The group number of the currently playing track will appear on the right. If the track does not belong to any group, the group number will be indicated by “--.”

- 4 Press GROUP SKIP ►► or GROUP SKIP ◀◀ while holding down SHIFT to select the group you want to move.

G      +G      3?

OK? SET

Ex.: When group 3 is selected.

- 5 Press SET.

G      +G      3?

OK? SET

- To cancel the setting, press CANCEL, then repeat from step **4**.

- 6 Press GROUP SKIP ►► or GROUP SKIP ◀◀ while holding down SHIFT to select the position where you want to move the group.

G      +G      3?

OK? SET

Ex.: When group 3 is moved to group 10.

- 7 Press SET.

<MOVE GR>  
YES? ENTER

- To cancel the setting, press CANCEL, then repeat from step **4**.

- 8 Press ENTER.

“EDITING” appears in the main display for a while, then “WRITING” and the MD REC indicator flashes while the changes you have made are recorded on the MD.

## Ungrouping Tracks—UNGROUP

This function allows you to dissolve a group. You cannot erase the tracks using this function. Once tracks are ungrouped, the other groups are renumbered.

- To stop any time during the editing process before step 6, press MD GROUP TITLE/EDIT.

### On the remote control ONLY:

In the following example, the process is explained from the very beginning—that is, inserting a disc. You can also edit an MD during playback (in normal play mode).

- 1 Insert an MD you want to edit into the MD loading slot.

- 2 Press MD GROUP TITLE/EDIT repeatedly until “UNGROUP ?” appears in the main display.

```

UNGROUP  ?
YES? → SET
  
```

- If you want to stop this editing process, press CANCEL.

- 3 Press SET.

```

Group No.
  |
GROUP 1?
YES? → SET
  
```

- If the loaded MD has no groups, you cannot go on to the following steps.
- During playback:** The group number of the currently playing track will appear. If the track does not belong to any group, the group number will be indicated by “—.”

- 4 Press GROUP SKIP ►► or GROUP SKIP ◄◄ while holding down SHIFT to select the group you want to dissolve.

```

GROUP 3?
YES? → SET
  
```

Ex.: When group 3 is selected.

- 5 Press SET.

```

<UNGROUP>
YES? → ENTER
  
```

- To cancel the setting, press CANCEL, then repeat from step 4.

- 6 Press ENTER.

“EDITING” appears in the main display for a while, then “WRITING” and the MD REC indicator flashes while the changes you have made are recorded on the MD.

## Dissolving All Groups—UNGR ALL

This function allows you to dissolve all the groups. You cannot erase the tracks using this function.

- To stop any time during the editing process before step 4, press MD GROUP TITLE/EDIT.

### On the remote control ONLY:

In the following example, the process is explained from the very beginning—that is, inserting a disc. You can also edit an MD during playback (in normal play mode).

- 1 Insert an MD you want to edit into the MD loading slot.

- 2 Press MD GROUP TITLE/EDIT repeatedly until “UNGR ALL ?” appears in the main display.

```

UNGR ALL  ?
YES? → SET
  
```

- If you want to stop this editing process, press CANCEL.

- 3 Press SET.

```

<UNGR ALL>
YES? → ENTER
  
```

- To cancel the setting, press CANCEL.

- 4 Press ENTER.

“EDITING” appears in the main display for a while, then “WRITING” and the MD REC indicator flashes while the changes you have made are recorded on the MD.

## Erasing Tracks in a Group—ERASE GR

This function allows you to erase a group together with tracks in the group.

You cannot recover the tracks in the erased group.

Once a group is erased, the other tracks and groups are renumbered.

- To stop any time during the editing process before step **6**, press MD GROUP TITLE/EDIT.

### On the remote control ONLY:

In the following example, the process is explained from the very beginning—that is, inserting a disc. You can also edit an MD during playback (in normal play mode).

- 1** Insert an MD you want to edit into the MD loading slot.

- 2** Press MD GROUP TITLE/EDIT repeatedly until “ERASE GR ?” appears in the main display.



ERASE GR ?  
ERASE ? -> SET

- If you want to stop this editing process, press CANCEL.

- 3** Press SET.

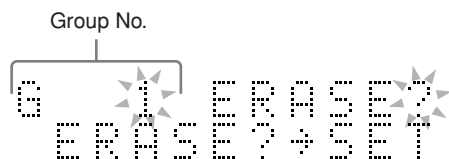

Group No.  
G 1 ERASE ?  
ERASE ? -> SET

- If the loaded MD has no groups, you cannot go on to the following steps.
- **During playback:**  
The group number of the currently playing track will appear. If the track does not belong to any group, the group number will be indicated by “—.”

- 4** Press GROUP SKIP ►► or GROUP SKIP ◀◀ while holding down SHIFT to select the group you want to erase.



G 6 ERASE ?  
ERASE ? -> SET

Ex.: When group 6 is selected.

- 5** Press SET.



<ERASE GR>  
YES ? -> ENTER

- To cancel the setting, press CANCEL, then repeat from step **4**.

- 6** Press ENTER.

“EDITING” appears in the main display for a while, then “WRITING” and the MD REC indicator flashes while the changes you have made are recorded on the MD.

## Introducing Track Editing Functions

The groups and tracks can be edited in many ways (the group editing functions and the track editing functions). From this page to page 79, the track editing functions are explained. For details of the group editing functions, see pages 67 to 74.

### Dividing a track (DIVIDE): Page 76

This function divides a track by adding a track mark at the desired point in the middle or where you want to search for later.

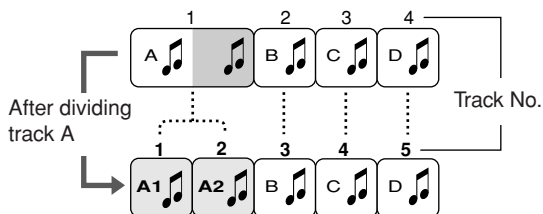

### Joining two tracks (JOIN): Page 77

This function joins two adjacent tracks into a single track by deleting a track mark.

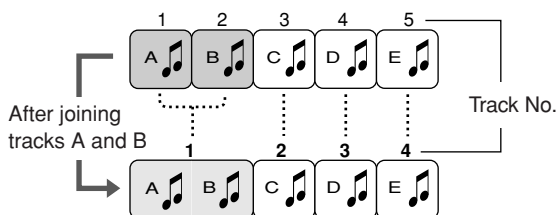

### Moving a track (MOVE): Page 78

This function moves a track by reordering the track numbers.

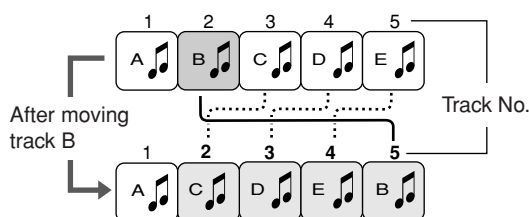

### Erasing tracks (ERASE): Page 79

This function erases selected tracks. After the erasure, the subsequent tracks are justified and their track numbers are renumbered automatically. You can erase up to 15 tracks at a time.

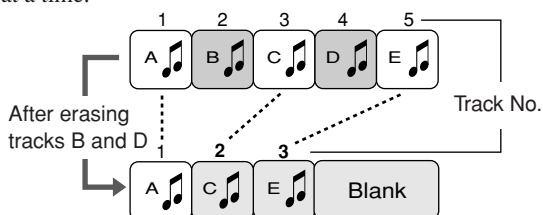

### Erasing all tracks (ALL ERASE): Page 79

This function erases data on a disc entirely.

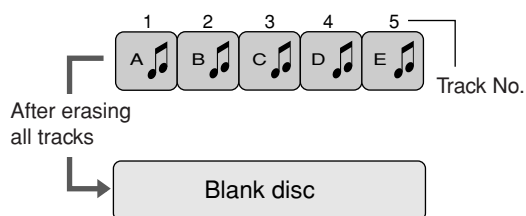

### Erasing a portion of a track

By combining "DIVIDE," "ERASE" and "JOIN," for example, it is possible to erase only a part of an existing track.

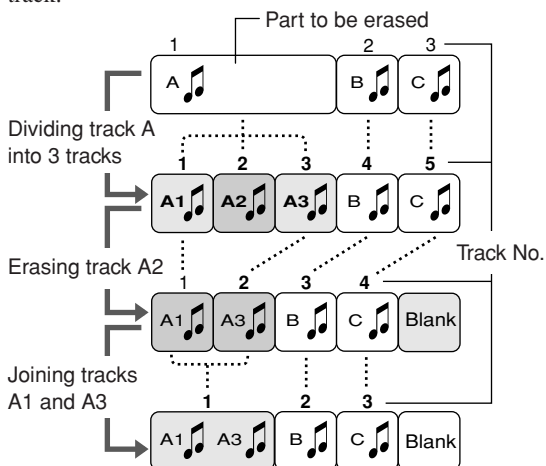

If "PLAYBACK DISC" or "DISC PROTECTED" appears when you try to edit an MD

You cannot edit such MDs. (See pages 95 and 96.)



During the program or random play mode

You can edit the MD as long as playback is stopped. However, editing groups and/or tracks will restore normal play mode (the program in memory will be cleared).

## Dividing a Track—DIVIDE

This function allows you to divide one track into two separate tracks. It is useful, for example, when you want to add track marks at a certain point within a track or if you want to separate a recording.

When the original track has a title, both new tracks are reassigned the same title as the original track.

Once a track is divided, the other tracks are renumbered.

- To stop any time during the editing process before step 8, press MD TITLE/EDIT.

### On the remote control ONLY:

In the following example, the process is explained from the very beginning—that is, inserting a disc. You can also edit an MD during playback (in normal play mode).

**1** Insert an MD you want to edit into the MD loading slot.

**2** Press MD TITLE/EDIT repeatedly until “DIVIDE ?” appears in the main display.

```

  DIVIDE
  YES? → SET
  
```



- If the loaded MD has no tracks, “DIVIDE ?” will not appear.
- If you want to stop this editing process, press CANCEL.

**3** Press SET.

The first track on the MD starts playback repeatedly.

**4** Press ►► or ◀◀ to select the track you want to divide.

- You can select the track using the number buttons.

```

  Track No.      Elapsed playing time
  ┌───┬───┐     ┌───┬───┐
  │ 12 │     │ 2:50 │
  └───┴───┘     └───┴───┘
  YES? → SET
  
```

Ex.: When track 12 is selected.

- If you press and hold ►► (or ◀◀), you can fast-forward (or fast-reverse) the selected track.

**5** Press SET when you find the point where you want to divide the track.

“POSIT. (position) 0” appears in the main display, and the unit repeats the selected point—a 3-second period following the dividing point.

```

  POSIT. 0
  OK? → SET
  
```

- If the loaded MD has 254 tracks, “DISC FULL” will appear (see “MD limitations” on page 96) and you cannot go on to the following steps.
- If the dividing point is satisfactory, go to step 7. If not, go to the next step.
- To cancel the setting, press CANCEL, then repeat from step 4.

**6** Press Cursor ◀▶ to precisely adjust the dividing point.

When you stop pressing the buttons, the unit repeats the newly selected dividing point.

- You can shift the dividing point up to  $\pm 128$ . This range ( $\pm 128$ ) corresponds to approximately  $\pm 8^*$  seconds from the original point (Position 0).

```

  POSIT. -103
  OK? → SET
  
```

Ex.: When adjusting the point by -103.

\* When the recording length mode of the selected track is “SP.” For “LP2,” it is approximately  $\pm 16$  seconds, and for “LP4” approximately  $\pm 32$  seconds.

- When you find the right position, go to the next step.
- To cancel the setting, press CANCEL, then repeat from step 4.

**7** Press SET.

```

  <DIVIDE>
  YES? → ENTER
  
```

**8** Press ENTER.

“EDITING” appears in the main display for a while, then “WRITING” and the MD REC indicator flashes while the changes you have made are recorded on the MD.

To join the divided tracks again, see the JOIN function on page 77.

## Joining Two Tracks—JOIN

This function allows you to join two adjacent tracks into one track.

When the tracks have their own titles, the title of the preceding track is reassigned to the newly joined track. Once two tracks are joined, the other tracks and/or the groups are renumbered.

- To stop any time during the editing process before step 6, press MD TITLE/EDIT.

### On the remote control ONLY:

In the following example, the process is explained from the very beginning—that is, inserting a disc. You can also edit an MD during playback (in normal play mode).

**1** Insert an MD you want to edit into the MD loading slot.

**2** Press MD TITLE/EDIT repeatedly until “JOIN ?” appears in the main display.

JOIN  
YES? → SET



- If the loaded MD has no tracks, “JOIN ?” will not appear.
- If you want to stop this editing process, press CANCEL.

**3** Press SET.

Track Nos. to be joined

1 2 3 4 5 6 7 8 9 10

← →

OK? → SET



- If the loaded MD has only one track, you cannot go on to the following steps.

**4** Press ►► or ◀◀ to select the two adjacent tracks you want to join.

- You can select the tracks using the number buttons, by selecting the succeeding track of two you want to join. In this case, the selected track starts playback repeatedly.

2 3

OK? → SET



Ex.: When tracks 2 and 3 are selected.

**5** Press SET.

<JOIN>  
YES? → ENTER

- To cancel the setting, press CANCEL, then repeat from step 4.

**6** Press ENTER.

“EDITING” appears in the main display for a while, then “WRITING” and the MD REC indicator flashes while the changes you have made are recorded on the MD.

To divide the track again, see the DIVIDE function on page 76.



### If “CANNOT JOIN” appears in step 5

You cannot join the following tracks.

- Tracks recorded using different MD recording length modes (SP, LP2, LP4). (See page 58.)
- Digital-recording tracks and analog-recording tracks.
- Tracks recorded using the monaural long recording method (not available on this unit) and stereo-recording tracks.



### When the track belongs to a group

If the preceding track of two tracks you want to join belongs to a group, the newly joined track will belong to that group. On the other hand, if the preceding track does not belong to any group, the newly joined track will not belong to any group even if the succeeding track belongs to a group.



## Moving a Track—MOVE

This function allows you to move a track to the position you prefer. It is useful to change the order of the tracks as you like.

Once a track is moved, the tracks and/or the groups are renumbered.

- To stop any time during the editing process before step **8**, press MD TITLE/EDIT.

### On the remote control ONLY:

In the following example, the process is explained from the very beginning—that is, inserting a disc. You can also edit an MD during playback (in normal play mode).

- 1** Insert an MD you want to edit into the MD loading slot.

- 2** Press MD TITLE/EDIT repeatedly until “MOVE ?” appears in the main display.

MOVE  
YES? → SET



- If the loaded MD has no tracks, “MOVE ?” will not appear.
- If you want to stop this editing process, press CANCEL.

- 3** Press SET.

Track No. to be moved from

1

OK? → SET



- If the loaded MD has only one track, you cannot go on to the following steps.

- 4** Press ►► or ◀◀ to select the track you want to move.

- You can select the track using the number buttons. In this case, the selected track starts playback repeatedly.

3

OK? → SET



Ex.: When track 3 is selected.

- 5** Press SET.

Track No. to be moved to

8

OK? → SET



- To cancel the setting, press CANCEL, then repeat from step **4**.

- 6** Press ►► or ◀◀ to select the position where you want to move the track.

- You can select the track using the number buttons. In this case, the selected track starts playing repeatedly.

8

OK? → SET



Ex.: When track 3 is moved to track 8.

- If the track selected in this step belongs to a group, the track selected in step **4** will be entered into the same group after moving.

- 7** Press SET.

<MOVE>  
YES? → ENTER

- To cancel the setting, press CANCEL, then repeat from step **4**.

- 8** Press ENTER.

“EDITING” appears in the main display for a while, then “WRITING” and the MD REC indicator flashes while the changes you have made are recorded on the MD.

## Erasing Tracks—ERASE

This function allows you to erase unwanted tracks.  
You cannot recover the erased tracks.  
Once tracks are erased, the other tracks and/or groups are renumbered.

You can erase up to 15 tracks at a time.

- To stop any time during the editing process before step 8, press MD TITLE/EDIT.

### On the remote control ONLY:

In the following example, the process is explained from the very beginning—that is, inserting a disc. You can also edit an MD during playback (in normal play mode).

- 1 Insert an MD you want to edit into the MD loading slot.

- 2 Press MD TITLE/EDIT repeatedly until “ERASE?” appears in the main display.

```

ERASE?
YES? → SET
  
```

- If the loaded MD has no tracks, “ERASE?” will not appear.
- If you want to stop this editing process, press CANCEL.

- 3 Press SET.

```

Track No.
 1 ERASE?
ERASE? → SET
  
```

- 4 Press ►► or ◀◀ to select the track you want to erase.
  - You can select the track using the number buttons. In this case, the selected track starts playback repeatedly.

- 5 Press SET.
 

“✓” appears in the main display.  
The track marked with “✓” will be erased.

```

✓ 5 ERASE?
NO? → CANCEL
  
```

Ex.: When track 5 is selected.

- If you do not want to erase the track, press CANCEL to remove “✓”.

- 6 Repeat steps 4 and 5 to select all the tracks you want to erase.

- You can select up to 15 tracks. If you select a 16th track to erase, “MEMORY FULL” will appear in the main display.

- 7 Press ENTER.

```

<ERASE>
YES? → ENTER
  
```

- 8 Press ENTER.

“EDITING” appears in the main display for a while, then “WRITING” and the MD REC indicator flashes while the changes you have made are recorded on the MD.

## Erasing All Tracks—ALL ERASE

This function allows you to erase all the data on an MD.  
You cannot recover the erased data.

### On the remote control ONLY:

In the following example, the process is explained from the very beginning—that is, inserting a disc. You can also edit an MD during playback (in normal play mode).

- 1 Insert an MD you want to edit into the MD loading slot.

- 2 Press MD TITLE/EDIT repeatedly until “ALL ERASE?” appears in the main display.

```

ALL ERASE?
YES? → SET
  
```

- If you want to stop this editing process, press CANCEL.

- 3 Press SET.

```

<ALL ERASE>
YES? → ENTER
  
```

- To cancel the setting, press CANCEL.

- 4 Press ENTER.

“EDITING” appears in the main display for a while, then “WRITING” and the MD REC indicator flashes while the changes you have made are recorded on the MD.

“BLANK DISC” appears in the main display.

## Assigning Titles to an MD

You can assign a name to each MD, to each group and to each track using alphabetic characters (uppercase and lowercase), symbols and numerals. Once a title is assigned, it is displayed for your confirmation.

- You cannot edit titles composed of more than 61 characters.

### About the number of characters entered for an MD

The total number of characters that you can enter for an MD is 1792. The maximum number that you can enter for each title is 61. (However, the actual number you can enter may be slightly less than these maximum numbers due to MD limitations—see page 96.)

- A space can be counted as one character.
- When the stereo long-hour recording (LP2 or LP4, see page 58) method is used for recording, the maximum number you can enter for a track title is automatically reduced since "LP:" and a space are automatically added to the beginning of the track title. Consequently this reduces the total number of characters you can enter for an MD.

Ex.: You can enter up to 10 characters for each track if an MD is composed of 120 tracks recorded using the stereo long-hour recording method.

In the following example, the process is explained from the very beginning—that is, inserting a disc. If you have already started recording or playing, start from step 2.

- You can also edit titles during playback (in normal play mode).
- To exit from the title entry screen any time during the process, press MD TITLE/EDIT or MD GROUP TITLE/EDIT repeatedly.

**1** Insert an MD you want to edit into the MD loading slot.

**2** Put the unit into the title entry mode.

### For the disc and track title:

Press MD TITLE/EDIT.

The Disc title entry screen appears in the main display.

```
DISC TITLE?
YES?+SET
```

### For the group title:

Press MD GROUP TITLE/EDIT.

The Group title entry screen appears in the main display.

```
GR--TITLE?
YES?+SET
```

**3** Press Cursor  $\blacktriangleright/\blacktriangleleft$  to change the title entry mode.

- Each time you press the button, the title entry mode changes as follows:

### For the disc and track title:

```
DISC TITLE? ↔ 1 TITLE? ↔ 2 TITLE? ←
The last track title ↔ ... ↔ 3 TITLE? ←
```

### For the group title:

```
GR--TITLE? → GR1 TITLE? ←
The last group title ↔ ... ↔ GR2 TITLE? ←
```

**4** Press SET to enter the selected title entry mode.

```
DISC>#
[ a ]
Character entry position
Character set
```

Ex.: When the disc has no title.

Continued next page 

## 5 Enter characters.

### 1) Press DISP/CHARA to select the character set you want.

- Each time you press the button, the character set changes as follows:

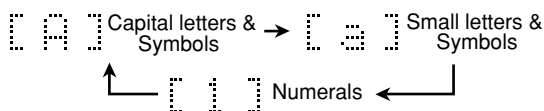

### 2) Press the character entry button for a character you want to input.

Ex.:

- To enter an "A" or "a," press ABC once.  
To enter a "B" or "b," press ABC twice.  
To enter a "C" or "c," press ABC three times.
- To enter a symbol, press MARK repeatedly until the mark you want appears.

Available symbols:

(Blank)	!	"	#	\$	%	&	'	( )
*	+	,	-	.	/	:	;	< =
>	?	@	_	\				

- To enter a numeral, press 0 – 9.
- To enter a space while entering a title, press Cursor ► twice.
- To move the character entry position while entering a title, press Cursor ► or ◀\*.
- If you have entered an incorrect character, press Cursor ► or ◀ to select the character you want to correct, then press CANCEL to delete it.

\* If you press Cursor ◀ repeatedly during recording, the entered characters may be displayed incorrectly. In this case, press MD TITLE/EDIT or MD GROUP TITLE/EDIT, then repeat from step 2 again.

### 3) Repeat steps 5 – 1) and 5 – 2) to enter other characters.

- If the character you want to enter next is assigned to the same button you have just pressed in step 5 – 2), press Cursor ► once to move the character entry position to the right.
- There is a limitation of character numbers that the main display can show at a time. Each time you enter a character exceeding the limitation, the left-most character disappears from the main display.

## 6 Press ENTER to finish the current title entry.

The next title entry screen appears.

### For the disc title:

The track title entry screen for the track 1 appears.

### For the track title:

The next track title entry screen appears (or the unit exits from the title entry screen if the current track is the last one on the MD).

### For the group title:

The next group title entry screen appears (or the same screen still remains if the current group is the last one on the MD).

If you want to go on assigning a name, repeat steps 3 to 6.

## 7 Press CANCEL to exit from the title entry mode.

- During recording, do not go to the next step until the recording ends.

## 8 Press MD ▲ on the main unit to eject the MD.

"WRITING" and the MD REC indicator flash while the editing you have made is being recorded on the MD.



**When you unplug the AC power cord or if a power failure occurs before step 8**

The titles you have made are not record.

Be sure to eject an MD to record the titles before unplugging the power cord.



You can assign titles during play or recording

- **During playback:**
  - Entering a track title**  
The MD recorder repeats playback of the current track until you press ENTER in step 6 on page 81. When you press ENTER, the next track will be played.
  - Entering a disc title**  
The MD recorder repeats playback of all tracks of the MD until you press ENTER in step 6 on page 81. When you press ENTER, the MD recorder enters the track title entry mode.
  - Entering a group title**  
The MD recorder repeats playback of the tracks in the group until you press ENTER in step 6 on page 81. When you press ENTER, the MD recorder enters the next group title entry mode.
- **During recording:**
  - Entering a track title**  
The MD recorder continues recording even after you press ENTER in step 6 on page 81. When you press ENTER, a track title is assigned to the track where you have started the title entry. If you do not press ENTER before recording ends, the track title assigned will be canceled.
- **During Disc Synchronized Recording (see page 59):**  
You can assign the disc title, and 16 track titles one after another as recording goes on. The track titles you have entered are automatically assigned to the tracks recorded on the MD in sequential order. If you enter 17th track title or more, they are ignored.

## Changing the Title

You can make a correction or change the title.

- 1** Follow steps 1 to 4 on page 80.
- 2** Select the character you want to correct, by pressing Cursor ►/◀.
  - Make sure that the character you want to change is flashing.
- 3** Press CANCEL to delete the character you have selected in the above step.
  - To erase all the characters, press CANCEL repeatedly until all the characters are erased, then go to step 6 of the current procedure.
- 4** Input the correct character, referring to step 5 on page 81.
- 5** Repeat steps 2 to 4 of the current procedure to correct more characters.
- 6** Press ENTER to finish correcting the title.
  - If you want to correct another title, select another title entry mode by pressing Cursor ►/◀, press SET, then repeat from step 2 of the current procedure.
  - If you want to finalize the correction, go to the next step.
- 7** Press MD ▲ on the main unit to eject the MD. “WRITING” and the MD REC indicator flash while the changes you have made are recorded on the MD.



Using the setting menu, you can store the initial selection for audio languages (sound) and subtitle languages for DVD playback as well as other settings.

## Setting menu

### • LANGUAGE menu (see page 85)

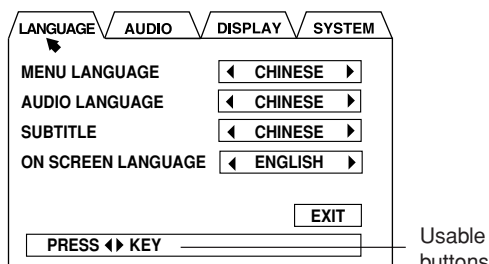

### • AUDIO menu (see page 85)

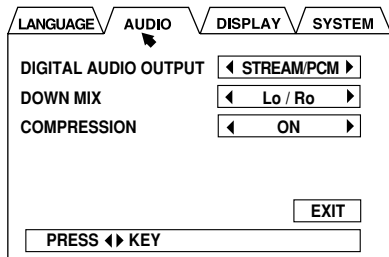

### • DISPLAY menu (see page 86)

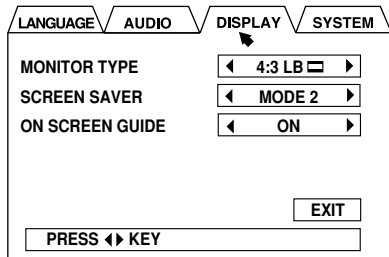

### • SYSTEM menu (see page 86)

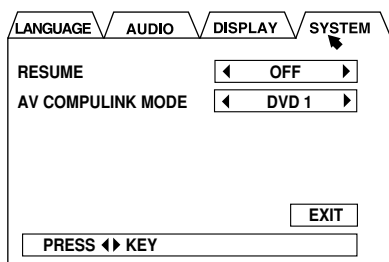

## Basic Procedure

The setting menu appears only when the selected source is the DVD player and the disc is not played back.

- When an Audio CD or MP3 disc is loaded, you cannot show the setting menu.

### On the remote control ONLY:

- 1 Press **CHOICE** while holding down **SHIFT**.  
The LANGUAGE menu appears on the TV.
- 2 Press **Cursor** **>/<** to move **▶** to the menu you want—**LANGUAGE, AUDIO, DISPLAY, or SYSTEM**.

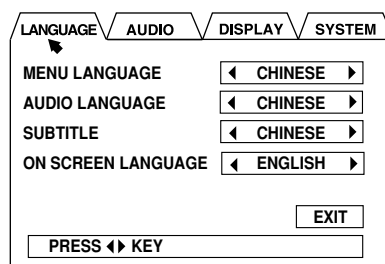

Ex.: When selecting LANGUAGE menu.

- 3 Press **Cursor** **▼/▲** to move **◀** to an item you want to set.

A selected item shows in green.

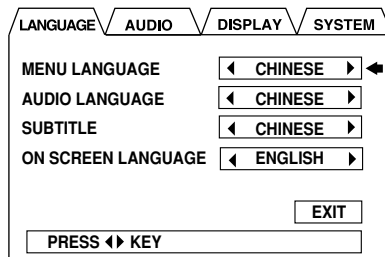

Ex.: When selecting "MENU LANGUAGE."

- 4 Press **Cursor** **>/<** to select a proper setting you want.
- 5 To set other items on the same menu, repeat steps 3 and 4.  
To set other items on the different menus, repeat steps 2 to 4.
- 6 When finished, press **Cursor** **▼** to move **◀** to "EXIT," then press **ENTER**.  
The setting menu disappears.

To exit from the setting menu any time during the above procedure, press **CHOICE** while holding down **SHIFT**. The setting menu disappears.  
The settings you have done up to that time will be stored.

## Changing the Initial Language Settings

On the LANGUAGE menu, you can select the following initial languages.

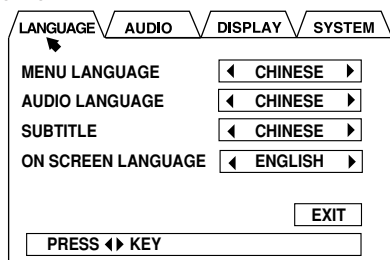

### • MENU LANGUAGE:

Select the initial language for the DVD disc menu. Selectable languages—ENGLISH, SPANISH, FRENCH, CHINESE, GERMAN, ITALIAN, JAPANESE, AA – ZU (Language code: See page 99.)

### • AUDIO LANGUAGE:

Select the initial language for audio sound language. Selectable languages—ENGLISH, SPANISH, FRENCH, CHINESE, GERMAN, ITALIAN, JAPANESE, AA – ZU (Language code: See page 99.)

### • SUBTITLE:

Select the initial language for subtitles. Selectable languages—ENGLISH, SPANISH, FRENCH, CHINESE, GERMAN, ITALIAN, JAPANESE, AA – ZU (Language code: See page 99.)

### • ON SCREEN LANGUAGE:

Select the language for the on-screen menus and indications. Selectable languages—ENGLISH, 中国语 (Chinese), ESPAÑOL (Spanish)



The original language will be selected as the initial language regardless of your setting in the following case:

- If the language you have selected is not recorded on the disc.
- If the disc is programmed to be played back in the original language.

## Changing the Various Audio Settings

On the AUDIO menu, you can change the following sound settings.

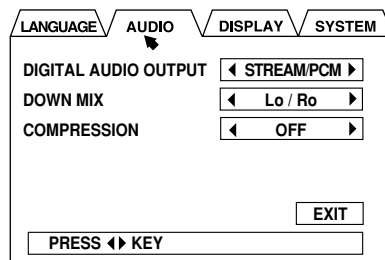

### • DIGITAL AUDIO OUTPUT:

Set the output signal type through the DVD OPTICAL DIGITAL OUTPUT terminal. (See also page 16.)

- Select “STREAM/PCM” when connecting an amplifier or a decoder compatible with Dolby Digital, DTS\*, and MPEG Multichannel.
- Select “PCM ONLY” when connecting an amplifier compatible only with Linear PCM, or a digital recording device such as an MD recorder, DAT deck, etc.
- Select “DOLBY DIGITAL/PCM” when connecting an amplifier or a decoder compatible only with Dolby Digital.

\* This unit does not have the DTS decoding function. To listen to DTS encoded sound, connect a DTS decoder or a DTS compatible amplifier.

### • DOWN MIX:

When playing a DVD whose audio sound is recorded with the multichannel surround, this unit properly converts the sound signals into 2-channels. Set this item according to your audio system.

- Select “Lt/Rt” when connecting an amplifier with the surround decoder.
- Select “Lo/Ro” when listening to the playback sound through the speaker connected to this unit or when recording on this unit. Also select “Lo/Ro” when connecting an amplifier without the surround decoder or a digital recording device.



### More about DOWN MIX

- The DOWN MIX function does not work when the 3D PHONIC function is activated. (See page 55.)
- The DOWN MIX setting does not affect DTS signals.



### • COMPRESSION:

When listening to the sound with only Dolby Digital, you can produce a powerful sound even at a low volume level by compressing the dynamic range (difference between the maximum and minimum sound levels).

- Select “**ON**” when you want to apply the compression effect (useful late at night).
- Select “**OFF**” when you want surround sound with its full dynamic range (no effect applied).



#### More about COMPRESSION

- The COMPRESSION function does not work when the 3D PHONIC function is activated. (See page 55.)
- The COMPRESSION function does not affect digital signals output through the DVD OPTICAL DIGITAL OUT terminal.

## Changing the Display Settings

On the DISPLAY menu, you can change the following display settings.

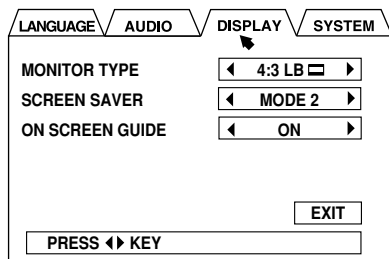

### • MONITOR TYPE:

Set the monitor type to use while playing back a DVD recorded with 16:9 wide screen video signal. (See also page 15.)

- Select “**4:3 LB (Letter Box)** ” when viewing on a TV whose aspect ratio is 4:3. While viewing a wide screen picture, the black bars appear on the top and the bottom of the screen.
- Select “**16:9 WIDE**” when viewing on a TV whose aspect ratio is 16:9.
- Select “**4:3 PS (Pan Scan)** ” when viewing on a TV whose aspect ratio is 4:3. While viewing a wide screen picture, the black bars do not appear; however, a portion of the left and right edges of the picture will not show on the screen.

### • SCREEN SAVER:

Select the screen saver to prevent the TV monitor from burning out. (See page 28.)

- Select “**MODE 1**” to activate the screen saver by making the TV screen dark.
- Select “**MODE 2**” to activate the screen saver by showing the original screen-saver.
- Select “**OFF**” to deactivate this function.

### • ON SCREEN GUIDE:

By watching the on-screen guide icons shown on the TV screen, you can see what you are doing while operating the DVD player. (See page 28.)

- Select “**ON**” to show the on-screen guide icons.
- Select “**OFF**” to deactivate this function.

## Changing the System Settings

On the SYSTEM menu, you can change the following settings.

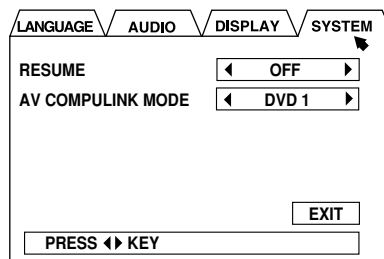

### • RESUME:

This unit can store the stop-point where DVD, SVCD or VCD playback stops. When you press DVD SELECT ► (or DVD ▷/|| on the main unit) to start playback again, it starts from where it has been stopped—Resume play.

- Pressing DVD ▲ to eject the disc erases the stored position.
- Select “**ON**” to activate Resume play.
- Select “**OFF**” to deactivate Resume play. Playback always starts from the beginning of a disc.

### • AV COMPULINK MODE :

When connecting this unit to a JVC TV with the AV COMPU LINK remote control system, select the proper setting. See page 93 for more details. Selectable modes—“DVD 1,” “DVD 2,” and “DVD 3.”

## Limiting Playback of DVD—Parental Lock

Using this function, you can restrict playback of DVD containing violent scenes (and those not suitable for your family members).

- This function is only possible for the DVDs containing such rating level information—Level 1 (most restrictive) to Level 8 (least restrictive).

### Setting the parental lock

You can set the parental lock only when a DVD is loaded and playback is stopped.

#### On the remote control ONLY:

- 1 Press ENTER while holding down ■. The PARENTAL LOCK screen appears on the TV.
  - When you set the parental lock for the first time, ◀ points to “Country Code.” (Go to step 3.)
  - When you change the parental lock settings, ◀ points to “PASSWORD.” (Go to step 2.)

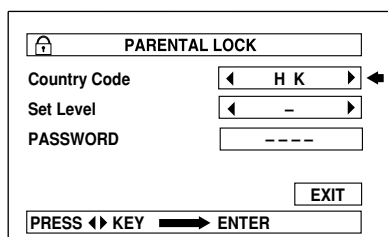

- 2 Press the number buttons (0 to 9) to enter the current password (4 digits), then press ENTER. ◀ moves to “Country Code.”
  - If you enter the wrong password, “WRONG! RETRY...” appears. Enter the correct password.

- 3 Press Cursor ▶/◀ repeatedly to select a proper country code, then press ENTER. ◀ moves to “Set Level.”
  - For country code list, see pages 100 and 101.

- 4 Press Cursor ▶/◀ repeatedly to select a parental lock level, then press ENTER. ◀ moves to “PASSWORD.”
  - Each time you press the button, the parental lock level changes as follows.  
You can play back only the DVD whose rating level is less than the level you set.

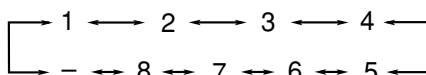

- If you do not want to make any restriction, select “-.”

- 5 Press the number buttons (0 – 9) to enter a new password (4 digits), then press ENTER.

◀ moves to “EXIT.”

- 6 Press ENTER. The parental lock level is set and the PARENTAL LOCK screen disappears.

To exit from the PARENTAL LOCK screen any time during the above procedure, press ENTER while holding down ■.



#### When you set the parental lock

- If you exit from the PARENTAL LOCK screen before finishing step 5, the setting you have made or changed is not stored. Repeat from step 1 again.
- If you enter the wrong password 3 times in step 2, ◀ moves to “EXIT” and Cursor ▲ and ▼ do not work. Press ENTER to exit from the PARENTAL LOCK screen, then repeat from step 1 again.
- If you forget your password, enter “8888.”

### Unlocking the Parental Lock Temporarily

Some discs cannot be played back at all when the parental lock is set. If you insert such a disc and try to play it, the following PARENTAL LOCK screen appears on the TV. You can unlock the parental lock setting temporarily on this screen.

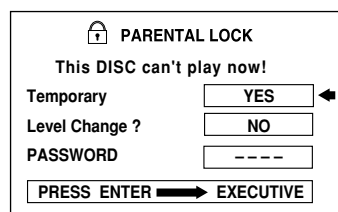

#### On the remote control ONLY:

- 1 Press Cursor ▲/▼ to select “YES,” then press ENTER. ◀ moves to “PASSWORD.”
  - When selecting “NO,” press DVD ▲ to remove the disc.

- 2 Press the number buttons (0 – 9) to enter the current password (4 digits). The parental lock is temporarily unlocked and playback starts.
  - If you enter the wrong password, “WRONG! RETRY...” appears. Enter the correct password.



#### If you enter the wrong password 3 times

- ◀ moves to “NO” and Cursor ▲ and ▼ do not work. Press DVD ▲ to remove the disc.
- If you forget your password, enter “8888.”

# Using the Timers

The buttons emphasized in the illustration below are used and explained in the following section (pages 89 to 92).

## Remote control

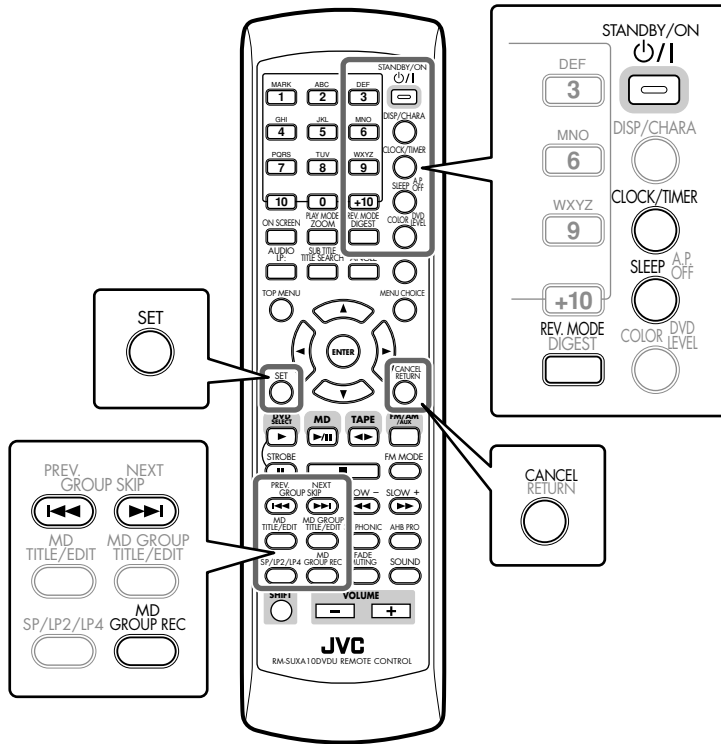

## Main unit

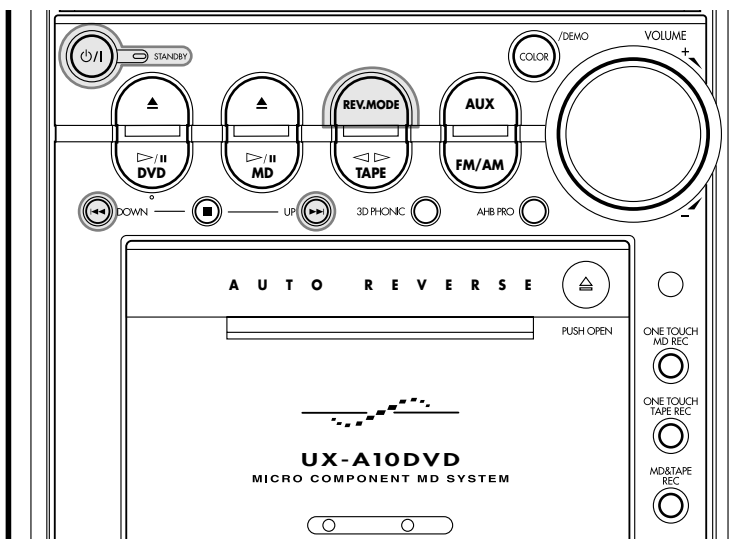

Three timers are available—Recording Timer, Daily Timer and Sleep Timer.

- Before using these timers, make sure the built-in clock is set correctly (see page 17).
- When using the tuner as the source, preset stations in advance (see page 26).

## Using the Recording Timer

With the Recording Timer, you can make an unattended recording.

- You can set the Recording Timer whether the unit is turned on or in standby mode.
- To correct a misentry any time during the setting process, press CANCEL.
- To exit from the timer setting mode during the setting process, press CLOCK/TIMER repeatedly until the source indication appears.

### How the Recording Timer actually works

The unit automatically turns on, muting the volume, and starts recording on the MD or the tape when the timer-on time comes. Then, when the timer-off time comes, the unit automatically turns off (stands by).

The Recording Timer works only once, but the timer settings remain stored in memory until you reset them or unplug the AC power cord.

#### 1 Press CLOCK/TIMER repeatedly until “REC TIMER” appears in the main display.

The timer (⌚) indicator lights up and the REC indicator starts flashing on the display.

```

REC TIMER
ON? → SET
    ↓
OFF? → CANCEL
  
```

- Each time you press the button, the timer mode change as follows:

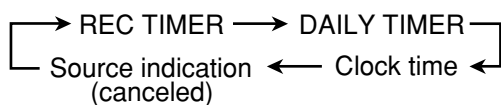

#### 2 Press SET.

The source name flashes in the main display.

#### 3 Select the source to record.

- 1) Press ►► or ◀◀ repeatedly to select the source.
  - Each time you press the button, the source changes as follows:

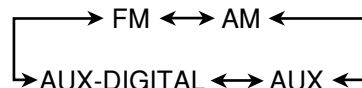

- When you select “FM” or “AM,” press SET, then select a preset number by pressing ►► or ◀◀.
- When you select “AUX” or “AUX-DIGITAL,” set the timer function of the external component as well.

- 2) Press SET.

The device to be recorded onto flashes in the main display.

#### 4 Select the device to be recorded onto.

- 1) Press ►► or ◀◀ repeatedly to select the device.

```
MD REC ↔ TAPE REC
```

- 2) Press SET.

- When you select “MD REC,” select the MD recording length mode (see page 59) by pressing ►► or ◀◀, then press SET again.
- When you select “TAPE REC,” select the reverse mode (see page 48) by pressing REV. MODE.

The hour digit of the timer-on time starts flashing.

#### 5 Set the timer-on time.

- 1) Press ►► or ◀◀ repeatedly to adjust the hour. You can adjust the hour using the number buttons.
- 2) Press SET. The minute digit starts flashing.
- 3) Press ►► or ◀◀ repeatedly to adjust the minute. You can adjust the minute using the number buttons.

```

REC TIMER
ON 11:30
    ↑
  
```

Ex.: When you set timer-on time to 11:30.

- 4) Press SET.

The hour digit of the timer-off time starts flashing.

## 6 Set the timer-off time.

- 1) Press **▶▶|** or **|◀◀** repeatedly to adjust the hour.  
You can adjust the hour using the number buttons.
- 2) Press **SET**.  
The minute digit starts flashing.
- 3) Press **▶▶|** or **|◀◀** repeatedly to adjust the minute.  
You can adjust the minute using the number buttons.

REC TIMER  
OFF 13:00

Ex.: When you set timer-off time to 13:00.

- 4) Press **SET**.  
The REC indicator stops flashing and remains lit.  
The contents of this setting appear in the main display for your confirmation.

## 7 Press **STANDBY/ON** (or **ON** on the main unit) to turn off the unit if necessary.



If the unit is already turned on when the timer-on time comes

The Recording Timer has no affect at all.

About 20 seconds before the timer-on time, the REC indicator and “REC TIMER STANDBY” start flashing on the display.

REC TIMER  
STANDBY

To record onto an MD using the Group recording, press MD GROUP REC to turn on the Group recording after setting the Recording Timer (before turning off the unit).



When you press **■** while the Recording Timer works

The recording stops but the timer function is not canceled. The unit automatically turns off (stands by) when the timer-off time comes.

To turn off the Recording Timer after its setting is done

- 1 Press **CLOCK/TIMER** repeatedly until “REC TIMER” appears in the main display.
- 2 Press **CANCEL**.  
The timer (  ) and REC indicators go off from the display.

To turn on the Recording Timer again

- 1 Press **CLOCK/TIMER** repeatedly until “REC TIMER” appears in the main display.
- 2 Press **SET** repeatedly until the settings are shown in the main display for your confirmation.  
The timer (  ) and REC indicators light up on the display.

## Using the Daily Timer

With the Daily Timer, you can wake up to your favorite music or radio program.

- You can set the Daily Timer whether the unit is turned on or in standby mode.
- To correct a mesentery any time during the setting process, press **CANCEL**.
- To exit from the timer setting mode during the setting process, press **CLOCK/TIMER** repeatedly until the source indication appears.

### How the Daily Timer actually works

The unit automatically turns on, and starts playing the specified source when the timer-on time comes. Then, when the timer-off time comes, the unit automatically turns off (stands by).

The Daily Timer repeats every day, and the timer settings remain stored in memory until you reset them or unplug the AC power cord.

## 1 Press **CLOCK/TIMER** repeatedly until “DAILY TIMER” appears in the main display.

The timer (  ) indicator lights up and the DAILY indicator starts flashing on the display.

DAILY TIMER  
ON? → SET  
OFF? → CANCEL

- Each time you press the button, the timer mode changes as follows:

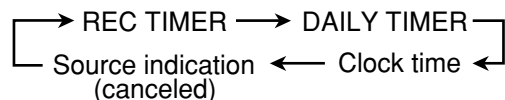

## 2 Press **SET**.

The source name flashes in the main display.

Continued next page 

### 3 Select the source to play back.

- 1) Press ►► or ◀◀ repeatedly to select the source.
  - Each time you press the button, the source changes as follows:

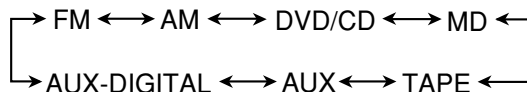

- You can also use the source selecting buttons.
  - When you select “DVD/CD,” “MD” or “TAPE,” prepare it for playing back.
  - When you select “FM” or “AM,” press SET, then select a preset number by pressing ►► or ◀◀.
  - When you select “AUX” or “AUX-DIGITAL,” set the timer function of the external component as well.
- 2) Press SET.  
The hour digit of the timer-on time starts flashing.

### 4 Set the timer-on time.

- 1) Press ►► or ◀◀ repeatedly to adjust the hour.  
You can adjust the hour using the number buttons.
- 2) Press SET.  
The minute digit starts flashing.
- 3) Press ►► or ◀◀ repeatedly to adjust the minute.  
You can adjust the minute using the number buttons.

DAILY TIMER  
ON 7:00

Ex.: When you set timer-on time to 7:00.

- 4) Press SET.  
The hour digit of the timer-off time starts flashing.

### 5 Set the timer-off time.

- 1) Press ►► or ◀◀ repeatedly to adjust the hour.  
You can adjust the hour using the number buttons.
- 2) Press SET.  
The minute digit starts flashing.
- 3) Press ►► or ◀◀ repeatedly to adjust the minute.  
You can adjust the minute using the number buttons.

DAILY TIMER  
OFF 8:00

Ex.: When you set timer-off time to 8:00.

- 4) Press SET.  
The volume setting appears in the main display.

### 6 Adjust the volume level.

- 1) Press ►► or ◀◀ repeatedly to adjust the volume level.
  - You can adjust the volume level to “—” or within the range of 0 (silent) to 40 (maximum).
  - When you select “VOLUME —,” the volume is set to the current volume level.

DAILY TIMER  
VOLUME

- 2) Press SET.  
The DAILY indicator stops flashing and remains lit.  
The contents of this setting appear in the main display for your confirmation.

### 7 Press STANDBY/ON ⏻/⏻ (or ⏻/⏻ on the main unit) to turn off the unit if necessary.



If the unit is already turned on when the timer-on time comes

The Daily Timer has no affect at all.

About 20 seconds before the timer-on time, the DAILY indicator and “DAILY TIMER STANDBY” start flashing on the display.

DAILY TIMER  
STANDBY

#### To turn off the Daily Timer after its setting is done

- 1 Press CLOCK/TIMER repeatedly until “DAILY TIMER” appears in the main display.
- 2 Press CANCEL.  
The timer (⌚) and DAILY indicators go off from the display.

#### To turn on the Daily Timer again

- 1 Press CLOCK/TIMER repeatedly until “DAILY TIMER” appears in the main display.
- 2 Press SET repeatedly until the settings are shown in the main display for your confirmation.  
The timer (⌚) and DAILY indicators light up on the display.



The Daily Timer will be canceled and the unit will not turn off automatically in the following cases:

- When you change the source.
- When you enter the MD editing or title entry mode.
- When you turn off the Daily Timer.

## Using the Sleep Timer

With the Sleep Timer, you can fall asleep to your favorite music or radio program.

- You can set the Sleep Timer when the unit is turned on.

### How the Sleep Timer actually works

The unit automatically turns off after the specified length of time passes.

#### On the remote control ONLY:

#### 1 Press SLEEP.

The timer (⌚) and SLEEP indicators start flashing on the display.

“SLEEP 10” appears in the main display for a while.

SLEEP 10

- Each time you press the button, the length of time changes as follows:

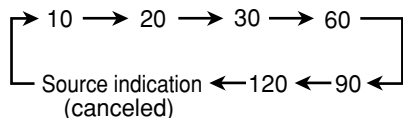

#### 2 Press SET or wait for about 5 seconds.

The illumination of the electronic swing panel and display window dim.

The timer (⌚) and SLEEP indicators stop flashing and remain lit.

**To check the remaining time until shut-off time,** press SLEEP once. The remaining time until shut-off time appears for about 5 seconds.

**To change the shut-off time,** press SLEEP repeatedly until the length of time you want appears.

**To cancel the setting,** press SLEEP repeatedly until the current source indication appears in the main display. The timer (⌚) and SLEEP indicators go off.



The Sleep Timer will be also canceled in the following cases:

- When you turn off the unit.
- When you operate other timer settings.
- When you adjust the clock.



The Sleep Timer and the Auto Power Off (see page 19) can be used at the same time.

## To sleep with the Sleep Timer and wake up with the Daily Timer

The unit turns off when the shut-off time comes (set by the Sleep Timer), and turns on when the timer-on time (set by the Daily Timer) comes.

- Set the Daily Timer as explained on pages 90 and 91.
- Start playing back any source you want to listen to before sleep.
- Set the Sleep Timer.

### Timer Priority

Since each timer can be set separately, you may wonder what happens if the setting for these timers overlaps. Here are the priorities for each timer.

- If the Recording Timer is set to come on earlier than the Daily Timer:

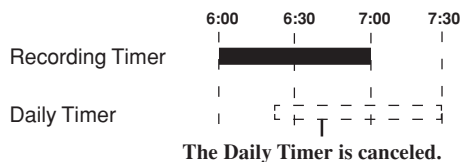

- If the Daily Timer is set to come on earlier than the Recording Timer:

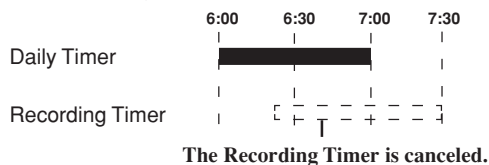

- If the Recording and Daily Timer is set to come on at the same time:

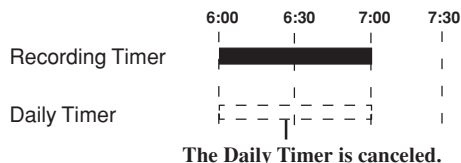

- If the Recording or Daily Timer is set to come on earlier than the shut-off time of the Sleep Timer:

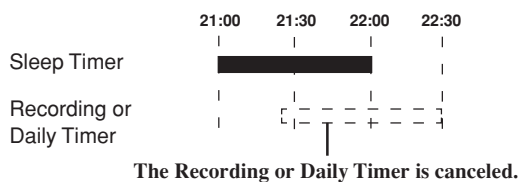

# Using AV COMPU LINK Control System

The AV COMPU LINK control system allows you to use JVC's TV with simple operations.

To use AV COMPU LINK control system, you need to connect this unit and a TV through the AV COMPU LINK terminals.

## AV COMPU LINK Connection

Connect JVC video components with AV COMPU LINK jack by using a cord with monaural mini-plugs (not supplied).

- You need to set "AV COMPULINK MODE" in the SYSTEM menu correctly to use AV COMPU LINK control system. (See page 86.)
- Refer also to the manual supplied with your TV.

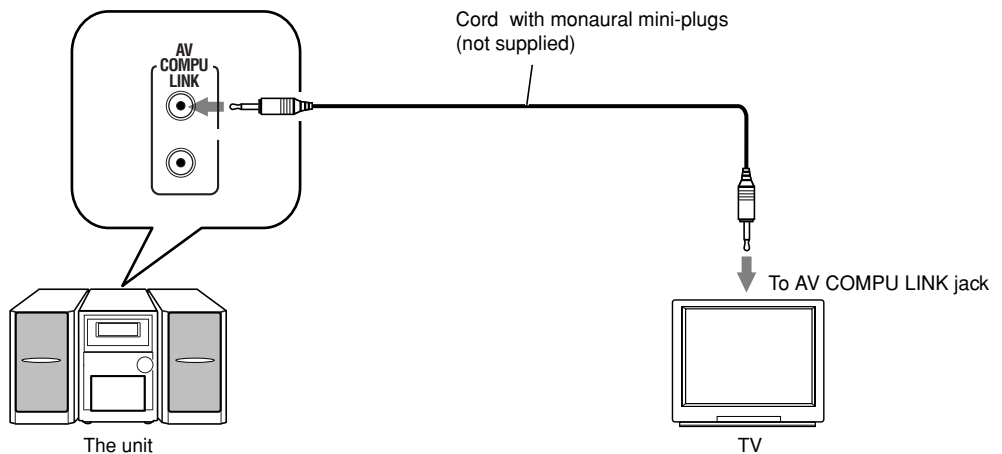

Set "AV COMPU LINK" in the SYSTEM menu as follows.

- Select "DVD 1" (initial setting) when connecting to the VIDEO-3 (DVD) input jack of the TV.
- Select "DVD 2" when connecting to the VIDEO-1 input jack of the TV.
- Select "DVD 3" when connecting to the VIDEO-2 input jack of the TV.



You can connect a JVC video component that has AV COMPU LINK II, AV COMPU LINK III, or AV COMPU LINK EX jack can be connected to this unit.

## One-touch DVD play

Simply by starting playback on the unit, the TV automatically turns on and changes the input mode to the appropriate position so that you can view the playback picture.

- The TV does not automatically turn off even if you turn off the unit.



When the main power of the TV is off or the power cord of the TV is unplugged, you cannot use the one-touch play.



# Maintenance

To get the best performance of the unit, keep your discs, tapes and mechanism clean.

## General Notes

In general, you will have the best performance by keeping your discs, MDs and the mechanism clean.

- Store discs and MDs in their cases, and keep them in cabinets or on shelves.
- Keep the electronic swing panel closed when not in use.

## Cleaning the unit

### • Stains on the unit

Should be wiped off with a soft cloth. If the unit is heavily stained, wipe it with a cloth soaked in water-diluted neutral detergent and wrung well, then wipe clean with a dry cloth.

### • Since the unit may deteriorate in quality, become damaged or get its paint peeled off, be careful about the following:

- DO NOT wipe it with a hard cloth.
- DO NOT wipe it strong.
- DO NOT wipe it with thinner or benzene.
- DO NOT apply any volatile substance such as insecticides to it.
- DO NOT allow any rubber or plastic to remain in contact with it for a long time.

## Handling discs



- Remove the disc from its case by holding it at the edge while pressing the center hole lightly.
- Do not touch the shiny surface of the disc, or bend the disc.
- Put the disc back in its case after use to prevent warping.

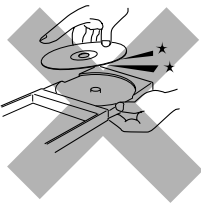

- Be careful not to scratch the surface of the disc when placing it back in its case.
- Avoid exposure to direct sunlight, temperature extremes, and moisture.



### To clean the disc

Wipe the disc with a soft cloth in a straight line from center to edge.



DO NOT use any solvent—such as conventional record cleaner, spray, thinner, or benzene—to clean the disc.

## Handling MDs

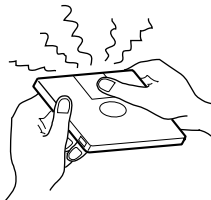

- Do not open the shutter.
  - The shutter is locked so that it will not open. Trying to force it open will break the MD. If the shutter opens accidentally, close it again quickly without touching the MD inside.

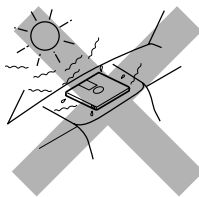

- Do not place MDs in the following places:
  - High temperature areas such as in direct sunlight or inside a car.
  - High humidity areas, e.g. in a bathroom.
  - On a beach or sandy area.

### • Clean MDs regularly.

- If dust or dirt gets on cartridge, wipe it off with a soft dry cloth.

## Handling cassette tapes

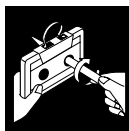

- If the tape is loose in its cassette, take up the slack by inserting a pencil in one of the reels and rotating.
- If the tape is loose, it may get stretched, cut, or caught in the cassette.



- Be careful not to touch the tape surface.



- Avoid the following places to store the tape:
  - In dusty places
  - In direct sunlight or heat
  - In moist areas
  - On a TV or speaker
  - Near a magnet

# Disc/MD Messages

## For discs:

Message	Signification	Solution
NO DISC	No disc is on the disc tray.	Place a disc on the disc tray.
ERROR	You are trying to play back a CD-R/RW which has not been "finalized."	This is not a malfunction. You can play back "finalized" CD-R/RWs.
REGION CODE ERROR	The unit and disc Region Code number are incompatible.	Change the disc. (See page 28.)

## For MD:

Message	Signification	Solution
BLANK DISC	The disc is blank.	Change the MD if you want to enjoy playback.
CANNOT ENTRY!	The track has already been in the selected group.	This is not a malfunction. (See "Adding a Track to a Group—ENTRY GR" on page 69.)
CANNOT FORM!	You are trying to form a new group including other groups.	This is not a malfunction. (See "Forming a Group—FORM GR" on page 68.)
CANNOT GROUP!	There is no more space for storing information concerning MD group. (The information concerning MD group is recorded in the area where the titles are recorded.)	You cannot form a group any more on the MD. (Erase the disc or track titles you do not need.)
CANNOT JOIN	You are trying to join tracks (shorter than 8 seconds) or groups which cannot be joined.	This is not a malfunction. (See pages 71, 77 and 96.)
CANNOT TITLE	You are trying to enter the title on the MD which already has over 1 792 characters in total.	This is not a malfunction. (See "Assigning Titles to an MD" on page 80.)
DISC FULL	There is no more space on the MD or there are over 254 tracks.	Use another recordable MD or erase some tracks.
DISC PROTECTED	MD is write-protected.	Unprotect the MD or use another. (See page 57.)
EMERGENCY STOP	A malfunction has occurred during recording.	Stop playback, eject the MD and re-insert it.
GROUP FULL	You are trying to form over 99 groups.	This is not a malfunction. There can only be up to 99 groups on an MD.
GROUP TRACK	You are trying to make a group by including a track which belongs to another group.	This is not a malfunction. (See "Forming a Group—FORM GR" on page 68.)
LOAD ERROR	MD is not loaded correctly.	Eject the MD and re-insert it.
MD NO DISC	There is no MD.	Put an MD.
NON AUDIO CAN NOT COPY	You are trying to copy a non-audio disc like a CD-ROM.	Stop recording.
PLAYBACK DISC	You are trying to edit or record on a playback-only MD.	Use a recordable MD.

Message	Signification	Solution
READ ERROR	The UTOC fails to be read. (See below.)	Turn off the unit, then turn on it again.
SCMS CANNOT COPY	Digital copy of the 2nd generation is prohibited.	You cannot make a digital recording from a duplicated CD-R/RW onto an MD. If you try to do so, the unit will automatically convert the digital signals to analog signals.
TRACK PROTECTED	You are trying to edit the track recorded on the personal computer.	Follow the instructions shown in the main display. (Ex.: When "YES?→ENTER" and "NO?→CANCEL" appears in the main display alternately, press ENTER to make your edition; otherwise, press CANCEL.)

### UTOC (User Table Of Contents)

Found only on recordable MDs, this area contains sub-data (track number, recording data, etc.) which can be rewritten by the user.

UTOC enables us to search for tracks quickly and edit tracks on the MD.

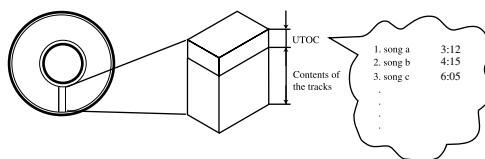

### MD limitations

The MD records data in an original format that differs from that of conventional cassette tapes or DATs. Since there are some limitations with this recording format, the following types of symptoms may occur. These symptoms are not malfunctions.

Symptoms	Cause
"DISC FULL" appears, even though there is still enough remaining time on an MD.	There is a maximum number of tracks which can be recorded, regardless of recording time. More than 254 tracks cannot be recorded on an MD.
"DISC FULL" appears, even though the number of tracks and recording time do not reach the limit.	<ul style="list-style-type: none"> <li>Repeating erasure and recording on the same MD creates many blank portions sparsely on the MD. When recording on such an MD, a track is recorded on these blank portions sparsely. If a track is divided and recorded into so many portions, "DISC FULL" appears.</li> <li>If a divided portion of less than 8 seconds is made while a track is recorded on the MD, that track cannot be joined to another track using the JOIN function. Furthermore, if that track is erased, the remaining time of the MD may not increase exactly by the erased amount.</li> <li>If a track has been divided into many portions while being recorded on the MD, sounds will drop out while fast forwarding or reversing such an MD.</li> </ul>
The JOIN function sometimes does not work.	
The remaining time on the MD does not increase even when tracks are erased.	
The sound drops out during fast forward or fast reverse.	
The amount of recorded time on the MD added to the amount of remaining time is shorter than the MD's total allowable recording time.	You cannot record on a blank portion of less than 12 seconds (SP mode) on the MD. For this reason, the actual recording time of discs may become shorter.

# Troubleshooting

If you are having a problem with your unit, check this list for a possible solution before calling for service.

If you cannot solve the problem from the hints given here, or the unit has been physically damaged, call a qualified person, such as your dealer, for service.

	Symptom	Possible Cause	Action
General	Power does not come on.	The power cord is not connected to an AC outlet.	Insert the plug into the socket.
	No sound is heard from the speakers.	<ul style="list-style-type: none"> <li>• Connections are incorrect or loose.</li> <li>• A pair of headphones is connected.</li> </ul>	<ul style="list-style-type: none"> <li>• Check all connections and make corrections. (See pages 8 to 13.)</li> <li>• Unplug the headphones from the PHONES jack.</li> </ul>
	Unable to operate the remote control.	<ul style="list-style-type: none"> <li>• The path between the remote control and the remote sensor on the unit is blocked.</li> <li>• The batteries have lost their charge.</li> <li>• You are using the remote control too far from the main unit.</li> </ul>	<ul style="list-style-type: none"> <li>• Remove the obstruction.</li> <li>• Replace the batteries. (See page 8.)</li> <li>• Signals cannot reach the remote sensor. Move close to the main unit.</li> </ul>
	Operations are disabled.	The built-in microprocessor has malfunctioned due to external electrical interference.	Unplug the AC power cord then plug it back in.
	The unit is shut off right after turning it on or starting playback.	The speaker cords are short-circuited or an internal malfunction with the unit occurred.	Unplug the AC power cord, check the connection of the speaker cords, then plug the AC power cord again. If the symptom still persists, consult your dealer.
Tuner	Poor radio reception.	<ul style="list-style-type: none"> <li>• The antenna is not connected correctly.</li> <li>• The AM loop antenna is too close to the unit.</li> <li>• The FM antenna is not properly extended and positioned.</li> </ul>	<ul style="list-style-type: none"> <li>• Reconnect the antenna securely.</li> <li>• Change the position and direction of the AM loop antenna.</li> <li>• Extend FM antenna and orient to the best reception position.</li> </ul>
Disc	Loaded disc cannot be ejected.	<ul style="list-style-type: none"> <li>• The main AC power cord is not plugged in.</li> <li>• The Disc Lock function is in use.</li> </ul>	<ul style="list-style-type: none"> <li>• Plug in the AC power cord.</li> <li>• Cancel the Disc Lock function. (See page 23.)</li> </ul>
	The disc does not play.	<ul style="list-style-type: none"> <li>• The CD is upside down.</li> <li>• The unit and disc Region Code numbers are incompatible.</li> <li>• Parental lock is in use.</li> </ul>	<ul style="list-style-type: none"> <li>• Put the CD in with the label side up.</li> <li>• Replace the disc. (See page 28.)</li> <li>• Unlock the parental lock. (See page 87.)</li> </ul>
	Video and audio are distorted.	<ul style="list-style-type: none"> <li>• The disc is dirty or scratched.</li> <li>• A VCR is connected between the unit and the TV.</li> </ul>	<ul style="list-style-type: none"> <li>• Clean or replace the disc. (See pages 28 and 94.)</li> <li>• Connect the unit and TV directly. (See page 10.)</li> </ul>

Symptom	Possible Cause	Action	
No picture appears on the screen.	<ul style="list-style-type: none"> <li>The video cord is not connected correctly.</li> <li>Incorrect color system is selected.</li> <li>An incorrect input has been selected on the TV or monitor.</li> </ul>	<ul style="list-style-type: none"> <li>Connect the video cord correctly.</li> <li>Select correct color system. (See page 10.)</li> <li>Select the correct input on the TV or monitor.</li> </ul>	Disc
Picture does not fit the television screen.	<ul style="list-style-type: none"> <li>“MONITOR TYPE” is not set correctly.</li> <li>The TV is not set correctly.</li> </ul>	<ul style="list-style-type: none"> <li>Select the monitor type correctly. (See pages 15 and 86.)</li> <li>Set the TV correctly.</li> </ul>	
No sound is heard.	<ul style="list-style-type: none"> <li>You are playing a disc encoded with DTS.</li> <li>MP3 disc is recorded with “packet writing.”</li> </ul>	<ul style="list-style-type: none"> <li>This unit cannot output DTS sound without connecting a decoder compatible with DTS (with “DIGITAL AUDIO OUTPUT” to “STREAM/PCM”—See page 85).</li> <li>It cannot be played. Replace the disc.</li> </ul>	
No subtitle appears on the display though you have selected the initial subtitle language.	Some DVDs are programmed always to display no subtitle initially.	Press SUB TITLE on the remote control after starting play. (See page 53.)	
Audio language is different from the one you have selected as the initial audio language.	Some DVDs are programmed always to use the original language initially.	Press AUDIO on the remote control after starting play. (See page 53.)	
While a DVD is played back, the sound is small as compared with other discs.	The audio sound of DVD is recorded at a lower level than the sounds of other discs such as VCDs or Audio CDs.	Increase the sound level of DVD playback. (See page 30.)	
Specific files (tracks) on an MP3 disc are not played.	Files other than MP3 are included in the disc.	They cannot be played.	
A particular function does not work during playback of an MP3 disc.	For MP3 discs, some functions do not work.	About unavailable functions for MP3 discs, see page 32.	
Unable to record on an MD.	<ul style="list-style-type: none"> <li>You are using a prerecorded MD.</li> <li>The MD is write-protected.</li> </ul>	<ul style="list-style-type: none"> <li>Change it for a recordable MD.</li> <li>Unprotect the MD. (See page 57.)</li> </ul>	MD
Loaded MD cannot be ejected.	<ul style="list-style-type: none"> <li>The main AC power cord is not plugged in.</li> <li>The Disc Lock function is in use.</li> </ul>	<ul style="list-style-type: none"> <li>Plug in the AC power plug.</li> <li>Cancel the Disc Lock function. (See page 23.)</li> </ul>	
Tape sound is at a very low level and the sound quality is degraded.	The tape head is dirty and magnetized.	Clean and demagnetize the head. (See page 62.)	Tape
The cassette holder does not open or close.	Power supply from the AC power cord has been cut off while the tape was running.	Turn on the unit.	
Impossible to record on a tape.	Small tabs on the back of the cassette are removed.	Cover the holes with adhesive tape. (See page 62.)	

# Table of Language Codes

This table is used when you select an audio language or a subtitle language (see page 53) and when you select a language in the LANGUAGE menu (see page 85).

Code	Language	Code	Language	Code	Language
AA	Afar	IK	Inupiak	RN	Kirundi
AB	Abkhazian	IN	Indonesian	RO	Rumanian
AF	Afrikaans	IS	Icelandic	RU	Russian
AM	Ameharic	IW	Hebrew	RW	Kinyarwanda
AR	Arabic	JI	Yiddish	SA	Sanskrit
AS	Assamese	JW	Javanese	SD	Sindhi
AY	Aymara	KA	Georgian	SG	Sangho
AZ	Azerbaijani	KK	Kazakh	SH	Serbo-Croatian
BA	Bashkir	KL	Greenlandic	SI	Singhalese
BE	Byelorussian	KM	Cambodian	SK	Slovak
BG	Bulgarian	KN	Kannada	SL	Slovenian
BH	Bihari	KO	Korean (KOR)	SM	Samoan
BI	Bislama	KS	Kashmiri	SN	Shona
BN	Bengali, Bangla	KU	Kurdish	SO	Somali
BO	Tibetan	KY	Kirghiz	SQ	Albanian
BR	Breton	LA	Latin	SR	Serbian
CA	Catalan	LN	Lingala	SS	Siswati
CO	Corsican	LO	Laothian	ST	Sesotho
CS	Czech	LT	Lithuanian	SU	Sundanese
CY	Welsh	LV	Latvian, Lettish	SV	Swedish
DA	Danish	MG	Malagasy	SW	Swahili
DZ	Bhutani	MI	Maori	TA	Tamil
EL	Greek	MK	Macedonian	TE	Telugu
EO	Esperanto	ML	Malayalam	TG	Tajik
ET	Estonian	MN	Mongolian	TH	Thai
EU	Basque	MO	Moldavian	TI	Tigrinya
FA	Persian	MR	Marathi	TK	Turkmen
FI	Finnish	MS	Malay (MAY)	TL	Tagalog
FJ	Fiji	MT	Maltese	TN	Setswana
FO	Faroese	MY	Burmese	TO	Tonga
FY	Frisian	NA	Nauru	TR	Turkish
GA	Irish	NE	Nepali	TS	Tsonga
GD	Scots Gaelic	NL	Dutch	TT	Tatar
GL	Galician	NO	Norwegian	TW	Twi
GN	Guarani	OC	Occitan	UK	Ukrainian
GU	Gujarati	OM	(Afan) Oromo	UR	Urdu
HA	Hausa	OR	Oriya	UZ	Uzbek
HI	Hindi	PA	Panjabi	VI	Vietnamese
HR	Croatian	PL	Polish	VO	Volapuk
HU	Hungarian	PS	Pashto, Pushto	WO	Wolof
HY	Armenian	PT	Portuguese	XH	Xhosa
IA	Interlingua	QU	Quechua	YO	Yoruba
IE	Interlingue	RM	Rhaeto-Romance	ZU	Zulu

# Table of Country/Area Codes

Continued 

This table is used when you set a country code for Parental Lock. (See page 87.)

Code	Country	Code	Country	Code	Country
AD	Andorra	CM	Cameroon	GR	Greece
AE	United Arab Emirates	CN	China	GS	South Georgia and the South Sandwich Islands
AF	Afghanistan	CO	Colombia	GT	Guatemala
AG	Antigua and Barbuda	CR	Costa Rica	GU	Guam
AI	Anguilla	CU	Cuba	GW	Guinea-Bissau
AL	Albania	CV	Cape Verde	GY	Guyana
AM	Armenia	CX	Christmas Island	HK	Hong Kong
AN	Netherlands Antilles	CY	Cyprus	HM	Heard Island and McDonald Islands
AO	Angola	CZ	Czech Republic	HN	Honduras
AQ	Antarctica	DE	Germany	HR	Croatia
AR	Argentina	DJ	Djibouti	HT	Haiti
AS	American Samoa	DK	Denmark	HU	Hungary
AT	Austria	DM	Dominica	ID	Indonesia
AU	Australia	DO	Dominican Republic	IE	Ireland
AW	Aruba	DZ	Algeria	IL	Israel
AZ	Azerbaijan	EC	Ecuador	IN	India
BA	Bosnia and Herzegovina	EE	Estonia	IO	British Indian Ocean Territory
BB	Barbados	EG	Egypt	IQ	Iraq
BD	Bangladesh	EH	Western Sahara	IR	Iran (Islamic Republic of)
BE	Belgium	ER	Eritrea	IS	Iceland
BF	Burkina Faso	ES	Spain	IT	Italy
BG	Bulgaria	ET	Ethiopia	JM	Jamaica
BH	Bahrain	FI	Finland	JO	Jordan
BI	Burundi	FJ	Fiji	JP	Japan
BJ	Benin	FK	Falkland Islands (Malvinas)	KE	Kenya
BM	Bermuda	FM	Micronesia (Federated States of)	KG	Kyrgyzstan
BN	Brunei Darussalam	FO	Faroe Islands	KH	Cambodia
BO	Bolivia	FR	France	KI	Kiribati
BR	Brazil	FX	France, Metropolitan	KM	Comoros
BS	Bahamas	GA	Gabon	KN	Saint Kitts and Nevis
BT	Bhutan	GB	United Kingdom	KP	Korea, Democratic People's Republic of
BV	Bouvet Island	GD	Grenada	KR	Korea, Republic of
BW	Botswana	GE	Georgia	KW	Kuwait
BY	Belarus	GF	French Guiana	KY	Cayman Islands
BZ	Belize	GH	Ghana	KZ	Kazakhstan
CA	Canada	GI	Gibraltar	LA	Lao People's Democratic Republic
CC	Cocos (Keeling) Islands	GL	Greenland	LB	Lebanon
CF	Central African Republic	GM	Gambia	LC	Saint Lucia
CG	Congo	GN	Guinea		
CH	Switzerland	GP	Guadeloupe		
CI	Côte d'Ivoire	GQ	Equatorial Guinea		
CK	Cook Islands				
CL	Chile				

Code	Country	Code	Country	Code	Country
LI	Liechtenstein	PE	Peru	TH	Thailand
LK	Sri Lanka	PF	French Polynesia	TJ	Tajikistan
LR	Liberia	PG	Papua New Guinea	TK	Tokelau
LS	Lesotho	PH	Philippines	TM	Turkmenistan
LT	Lithuania	PK	Pakistan	TN	Tunisia
LU	Luxembourg	PL	Poland	TO	Tonga
LV	Latvia	PM	Saint Pierre and Miquelon	TP	East Timor
LY	Libyan Arab Jamahiriya			TR	Turkey
MA	Morocco	PN	Pitcairn	TT	Trinidad and Tobago
MC	Monaco	PR	Puerto Rico	TV	Tuvalu
MD	Moldova, Republic of	PT	Portugal	TW	Taiwan
MG	Madagascar	PW	Palau	TZ	Tanzania, United Republic of
MH	Marshall Islands	PY	Paraguay		
ML	Mali	QA	Qatar	UA	Ukraine
MM	Myanmar	RE	Réunion	UG	Uganda
MN	Mongolia	RO	Romania	UM	United States Minor Outlying Islands
MO	Macau	RU	Russian Federation		
MP	Northern Mariana Islands	RW	Rwanda	US	United States
		SA	Saudi Arabia	UY	Uruguay
MQ	Martinique	SB	Solomon Islands	UZ	Uzbekistan
MR	Mauritania	SC	Seychelles	VA	Vatican City State (Holy See)
MS	Montserrat	SD	Sudan		
MT	Malta	SE	Sweden	VC	Saint Vincent and the Grenadines
MU	Mauritius	SG	Singapore		
MV	Maldives	SH	Saint Helena	VE	Venezuela
MW	Malawi	SI	Slovenia	VG	Virgin Islands (British)
MX	Mexico	SJ	Svalbard and Jan Mayen	VI	Virgin Islands (U.S.)
MY	Malaysia			VN	Viet Nam
MZ	Mozambique	SK	Slovakia	VU	Vanuatu
NA	Namibia	SL	Sierra Leone	WF	Wallis and Futuna Islands
NC	New Caledonia	SM	San Marino		
NE	Niger	SN	Senegal	WS	Samoa
NF	Norfolk Island	SO	Somalia	YE	Yemen
NG	Nigeria	SR	Suriname	YT	Mayotte
NI	Nicaragua	ST	Sao Tome and Principe	YU	Yugoslavia
NL	Netherlands	SV	El Salvador	ZA	South Africa
NO	Norway	SY	Syrian Arab Republic	ZM	Zambia
NP	Nepal	SZ	Swaziland	ZR	Zaire
NR	Nauru	TC	Turks and Caicos Islands	ZW	Zimbabwe
NU	Niue	TD	Chad		
NZ	New Zealand	TF	French Southern Territories		
OM	Oman				
PA	Panama	TG	Togo		



# Specifications

Design and specifications are subject to change without notice.

## Amplifier Section—CA-UXA10DVD

Output Power (IEC 268-3):	74 W (37 W + 37 W) at 6 $\Omega$ (10% THD)
Analog input	
AUX:	Sensitivity/Impedance (at 1 kHz) 500 mV/47 k $\Omega$ (at “LEVEL 1”) 200 mV/47 k $\Omega$ (at “LEVEL 2”)
Digital input*	
OPTICAL DIGITAL IN:	-21 dBm to -15 dBm (660 nm $\pm$ 30 nm)
* Corresponding to Linear PCM (with 32 kHz/44.1 kHz/48 kHz sampling frequency)	
Digital output	
DVD OPTICAL DIGITAL OUT:	-21 dBm to -15 dBm (660 nm $\pm$ 30 nm)
VIDEO OUT:	
Color system:	NTSC/PAL selectable
Composite:	1 V(p-p)/75 $\Omega$
S-video:	
Y (luminance)	1 V(p-p)/75 $\Omega$
C (chrominance, burst)	0.286 V(p-p)/75 $\Omega$
Speaker Terminals:	6 $\Omega$ - 16 $\Omega$

## Tuner

FM tuning range:	87.50 MHz—108.00 MHz
AM tuning range:	531 kHz—1 710 kHz (at 9 kHz channel spacing) 530 kHz—1 710 kHz (at 10 kHz channel spacing)

## DVD player

Readable discs:	DVD VIDEO, Super Video CD, Video CD, Audio CD
Dynamic range:	98 dB
Horizontal resolution:	500 lines
Wow and flutter:	Immeasurable

## MD recorder

Audio playing system:	MiniDisc digital audio system
Recording system:	Magneto-optical overwrite system
Reading system:	Non-contact, semiconductor laser pickup
Recording/Playback time (when using a 80-minute MD)	
SP:	80 minutes
LP2:	160 minutes
LP4:	320 minutes
Sampling frequency:	44.1 kHz
Audio compression system:	ATRAC (Adaptive TRansform Acoustic Coding)/ATRAC3 (MDLP)

## Cassette deck

Frequency response:	
Normal (type I):	60 Hz—14 000 Hz
Wow and flutter:	0.15 % (WRMS)

## General

Power requirement:	AC 220 V $\sim$ , 50 Hz
Power consumption:	
At operation:	105 W
On standby:	15 W
1.2 W (in power save mode)	
Dimensions (W/H/D) (approx.):	185 mm x 265 mm x 316 mm
Mass (approx.):	6.9 kg

## Supplied accessories

See “Unpacking” on page 8.

## Speaker Section—SP-UXA10DVD

Type:	3-way bass-reflex magnetically shielded type
Speakers:	Woofer 10 cm cone x1 Midrange 4 cm cone x1 Tweeter 2 cm dome x1
Impedance:	6 $\Omega$
Frequency range:	55 Hz to 20 kHz
Sound pressure level:	85.5 dB/W•m
Dimensions (W/H/D) (approx.):	153 mm x 266 mm x 211.5 mm
Mass (approx.):	3.0 kg each

US and foreign patents licensed from Dolby Laboratories.

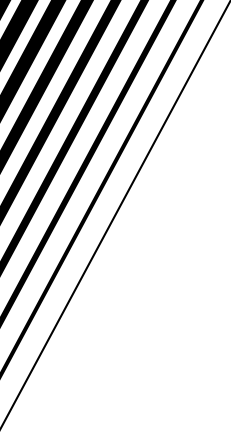

## Free Manuals Download Website

<http://myh66.com>

<http://usermanuals.us>

<http://www.somanuals.com>

<http://www.4manuals.cc>

<http://www.manual-lib.com>

<http://www.404manual.com>

<http://www.luxmanual.com>

<http://aubethermostatmanual.com>

Golf course search by state

<http://golfingnear.com>

Email search by domain

<http://emailbydomain.com>

Auto manuals search

<http://auto.somanuals.com>

TV manuals search

<http://tv.somanuals.com>