

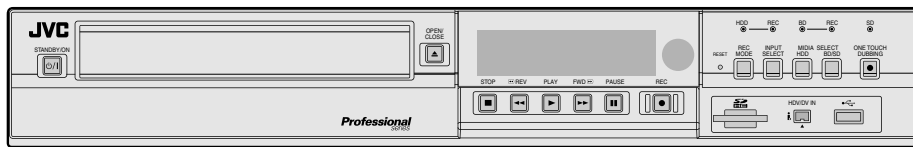

BLU-RAY DISC & HDD RECORDER

SR-HD1500US SR-HD1250US

INSTRUCTIONS (A)



For Customer Use:

Enter below the Model No. and Serial No. which are located on the rear of cabinet. Retain this information for future reference.

Model No. _____

Serial No. _____

Safety Precaution

Dear Customer,

Thank you for purchasing the JVC BLU-RAY DISC & HDD recorder. Before use, please read the safety information and precautions to ensure safe use of your new unit.

Cautions

CAUTION RISK OF ELECTRIC SHOCK DO NOT OPEN	AVIS RISQUE DE CHOC ELECTRIQUE - NE PAS OUVRIR.
This Class B digital apparatus complies with Canadian ICES-003. Cet appareil numérique de la classe B est conforme à la norme NMB-003 du Canada.	
 	



The lightning flash with arrowhead symbol, within an equilateral triangle, is intended to alert the user to the presence of uninsulated "dangerous voltage" within the product's enclosure that may be of sufficient magnitude to constitute a risk of electric shock to persons.



The exclamation point within an equilateral triangle is intended to alert the user to the presence of important operating and maintenance (servicing) instructions in the literature accompanying the appliance.

CAUTION:

A UNIT IS A CLASS 1 LASER PRODUCT. HOWEVER THIS UNIT USES A VISIBLE LASER BEAM WHICH COULD CAUSE HAZARDOUS RADIATION EXPOSURE IF DIRECTED. BE SURE TO OPERATE THE UNIT CORRECTLY AS INSTRUCTED.

WHEN THIS UNIT IS PLUGGED INTO THE WALL OUTLET, DO NOT PLACE YOUR EYES CLOSE TO THE OPENING OF THE DISC TRAY AND OTHER OPENINGS TO LOOK INTO THE INSIDE OF THIS UNIT.

USE OF CONTROLS OR ADJUSTMENTS OR PERFORMANCE OF PROCEDURES OTHER THAN THOSE SPECIFIED HEREIN MAY RESULT IN HAZARDOUS RADIATION EXPOSURE.

DO NOT OPEN COVERS AND DO NOT REPAIR YOURSELF. REFER SERVICING TO QUALIFIED PERSONNEL.

CLASS 1 LASER PRODUCT

REPRODUCTION OF LABELS

WARNING LABEL INSIDE OF THE UNIT

CAUTION	CLASS 3B VISIBLE AND INVISIBLE LASER RADIATION WHEN OPEN, AVOID EXPOSURE TO THE BEAM.
ATTENTION	RADIATIONS LASER VISIBLES ET INVISIBLES DE CLASSE 3B QUAND OUVERT. ÉVITEZ TOUT EXPOSITION AU FAISCEAU.
ADVARSEL	KLASSE 3B SYNLIG OG USYNLIG LASERSTRÅLING VED ÅBNING. UNDGÅ UDSÆTTELSE FOR STRÅLING.
WARNING	KLASS 3B SYNLIG OCH OSYNLIG LASERSTRÅLNING NÄR DENNA DEL ÄR ÖPPNAD. UNDVIK ATT UTSÄTTA DIG FÖR STRÅLEN.
VORSICHT	BE GEÖFFNETER ABDECKUNG IST SICHTBARE UND UNSICHTBARE LASERSTRÄHLUNG DER KLASSE 3B IM GERÄTENNEREN VORHANDEN. NICHT DEM LASERSTRÄHL AUSSETZEN!
PRECAUCIÓN	CUANDO SE ABRE HAY RADIACIÓN LÁSER DE CLASE 3B VISIBLE E INVISIBLE. EVITE LA EXPOSICIÓN A LOS RAYOS LÁSER.
VARO!	AVATTAESSA OLET ALTIINA NÄKYVÄLLE JA NÄKYMÄTTÖMÄLLE LUOKAN 3B LASERSÄTELYLLE. ÄLÄ KATSO SÄTEESEEN.
注意	ここを開くと CLASS 3B の可視レーザー光及び不可視レーザー光が出ます。ビームを直接見たり、触れたりしないこと。
DRW2382 - A	

This unit apply to the standard "IEC60825-1:2001" for laser products.

WARNING:

TO PREVENT FIRE OR SHOCK HAZARD, DO NOT EXPOSE THIS UNIT TO RAIN OR MOISTURE.

CAUTION:

This unit should be used with AC 120V, 60Hz only. To prevent electric shocks and fire hazards, DO NOT use any other power source.

CAUTION:

TO PREVENT ELECTRIC SHOCK, MATCH WIDE BLADE OF PLUG TO WIDE SLOT, FULLY INSERT.

ATTENTION:

POUR ÉVITER LES CHOCS ÉLECTRIQUES, INTRODUIRE LA LAME LA PLUS LARGE DE LA FICHE DANS LA BORNE CORRESPONDANTE DE LA PRISE ET POUSSER JUSQU'AU FOND.

Note to CATV system installer:

This reminder is provided to call the CATV system installer's attention to Article 820-40 of the NEC that provides guidelines for proper grounding and, in particular, specifies that the cable ground shall be connected to the grounding system of the building, as close to the point of cable entry as practical.

"WARNING" and the following or equivalent. "To reduce the risk of fire or electric shock, do not expose this apparatus to rain or moisture."

A warning that an apparatus with CLASS I construction shall be connected to a MAINS socket outlet with protective earthing connection.

WARNING

Batteries shall not be exposed to excessive heat such as sunshine, fire or the like.

Main Plug

The Main Plug is used as the disconnect device, the disconnect device shall remain readily operable

IMPORTANT SAFETY INSTRUCTIONS

- 1) Read these instructions.
- 2) Keep these instructions.
- 3) Heed all warnings.
- 4) Follow all instructions.
- 5) Do not use this apparatus near water.
- 6) Clean only with dry cloth.
- 7) Do not block any ventilation openings. Install in accordance with the manufacturer's instructions.
- 8) Do not install near any heat sources such as radiators, heat registers, stoves, or other apparatus (including amplifiers) that produce heat.
- 9) Do not defeat the safety purpose of the polarized or grounding-type plug. A polarized plug has two blades with one wider than the other. A grounding type plug has two blades and a third grounding prong. The wide blade or the third prong are provided for your safety. If the provided plug does not fit into your outlet, consult an electrician for replacement of the obsolete outlet.
- 10) Protect the power cord from being walked on or pinched particularly at plugs, convenience receptacles, and the point where they exit from the apparatus.
- 11) Only use attachments/accessories specified by the manufacturer.
- 12) Use only with the cart, stand, tripod, bracket, or table specified by the manufacturer, or sold with the apparatus. When a cart is used, use caution when moving the cart/apparatus combination to avoid injury from tip-over.
- 13) Unplug this apparatus during lightning storms or when unused for long periods of time.
- 14) Refer all servicing to qualified service personnel. Servicing is required when the apparatus has been damaged in any way, such as power-supply cord or plug is damaged, liquid has been spilled or objects have fallen into the apparatus, the apparatus has been exposed to rain or moisture, does not operate normally, or has been dropped.



Failure to heed the following precautions may result in damage to the unit, remote control or disc/cassette.

1. **DO NOT place the unit** —
 - in an environment prone to extreme temperatures or humidity.
 - in direct sunlight.
 - in a dusty environment.
 - in an environment where strong magnetic fields are generated.
 - on a surface that is unstable or subject to vibration.
2. **DO NOT block the unit's ventilation openings or holes.** (If the ventilation openings or holes are blocked by a newspaper or cloth, etc., the heat may not be able to get out.)
3. **DO NOT place heavy objects on the unit or remote control.**
4. **DO NOT place anything which might spill on top of the unit or remote control.** (If water or liquid is allowed to enter this equipment, fire or electric shock may be caused.)
5. **DO NOT expose the apparatus to dripping or splashing.**
6. **DO NOT use this equipment in a bathroom or places with water.** Also **DO NOT** place any containers filled with water or liquids (such as cosmetics or medicines, flower vases, potted plants, cups, etc.) on top of this unit.
7. **DO NOT place any naked flame sources, such as lighted candles, on the apparatus.**
8. **AVOID violent shocks to the unit during transport.**

CAUTION:

Changes or modifications not approved by JVC could void user's authority to operate the equipment.

Declaration of Conformity

Model Number: SR-HD1500US
 Trade Name: JVC
 Responsible Party: JVC Americas Corp.
 Address: 1700 Valley Road Wayne, N.J. 07470
 Telephone Number: 973-317-5000
 This device complies with Part 15 of FCC Rules.
 Operation is subject to the following two conditions:

(1) This device may not cause harmful interference, and (2) this device must accept any interference received, including interference that may cause undesired operation.

This equipment has been tested and found to comply with the limits for a Class B digital device, pursuant to Part 15 of the FCC Rules. These limits are designed to provide reasonable protection against harmful interference in a residential installation. This equipment generates, uses, and can radiate radio frequency energy and, if not installed and used in accordance with the instructions, may cause harmful interference to radio communications. However, there is no guarantee that interference will not occur in a particular installation. If this equipment does cause harmful interference to radio or television reception, which can be determined by turning the equipment off and on, the user is encouraged to try to correct the interference by one or more of the following measures:

Reorient or relocate the receiving antenna.

Increase the separation between the equipment and receiver.

Connect the equipment into an outlet on a circuit different from that to which the receiver is connected.

Consult the dealer or an experienced radio/TV technician for help.

When the equipment is installed in a cabinet or a shelf, make sure that it has sufficient space on all sides to allow for ventilation (10 cm or more on both sides, on top and at the rear).

When discarding batteries, environmental problems must be considered and the local rules or laws governing the disposal of these batteries must be followed strictly.

Use the supplied power cord.

(If not, fire or electric shock may be caused.)

DON'T continue to operate the equipment if you are in any doubt about it working normally, or if it is damaged in any way -- switch off, withdraw the mains plug and consult your dealer.

DO be careful with glass panels or doors on equipment.

DO consult you dealer if you are ever in doubt about the installation, operation or safety of your equipment.

NEVER let anyone especially children push anything into holes, slots or any other opening in the case -- this could result in a fatal electrical shock.

MOISTURE CONDENSATION

Moisture in the air will condense on the unit when you move it from a cold place to a warm place, or under extremely humid conditions—just as water droplets form on the surface of a glass filled with cold liquid. In conditions where condensation may occur, disconnect the unit's power plug from the wall and keep it disconnected for a few hours to let the moisture dry, then turn on the unit.

Safety Precaution



- Manufactured under license from Dolby Laboratories. Dolby and the double-D symbol are trademarks of Dolby Laboratories.
- Manufactured under license under U.S. Patent #'s: 5,451,942; 5,956,674; 5,974,380; 5,978,762; 6,226,616; 6,487,535; 7,392,195; 7,272,567; 7,333,929; 7,212,872 & other U.S. and worldwide patents issued & pending. DTS is a registered trademark and the DTS logos, Symbol, DTS-HD and DTS-HD Master Audio | Essential are trademarks of DTS, Inc. © 1996-2008 DTS, Inc. All Rights Reserved.
- This product incorporates copyright protection technology that is protected by U.S. patents and other intellectual property rights. Use of this copyright protection technology must be authorized by Macrovision, and is intended for home and other limited viewing uses only unless otherwise authorized by Macrovision. Reverse engineering or disassembly is prohibited.
- DVD logo is a registered trademark of DVD Format/Logo Licensing Corporation.
- HDMI, the HDMI logo and High-Definition Multimedia Interface are trademarks or registered trademarks of HDMI Licensing LLC.
- "Blu-ray Disc" and the "Blu-ray" logo are trademarks.
- "x.v.Color" and the "x.v.Color" logo are trademarks of Sony Corporation Co., Ltd.
- Java and all Java-based trademarks and logos are trademarks or registered trademarks of Sun Microsystems, Inc. in the United States and other countries.
- SDHC logo is trademark.
- "AVCHD" and the "AVCHD" logo are trademarks of Panasonic Corporation and Sony Corporation.
- Other product and company names included in this instruction manual are trademarks and/or registered trademarks of their respective holders.
- This product is licensed under the AVC patent portfolio license and VC-1 patent portfolio license for the personal and non-commercial use of a consumer to (i) encode video in compliance with the AVC Standard and VC-1 Standard ("AVC/VC-1 Video") and/or (ii) decode AVC/VC-1 Video that was encoded by a consumer engaged in a personal and non-commercial activity and/or was obtained from a video provider licensed to provide AVC/VC-1 Video. No license is granted or shall be implied for any other use. Additional information may be obtained from MPEG LA, LLC. See <http://www.mpegla.com>.

Batteries -- Incorrect use of batteries may cause the batteries to burst or ignite. A leaky battery may corrode the equipment, dirty your hands or spoil your clothing. In order to avoid these problems, make sure to observe the precautions below:

- Use the specified batteries only.
- Install the batteries with due attention to the plus (+) and minus (-) sides of the batteries according to the instructions in the compartment.
- Do not mix old and new batteries.
- Do not mix batteries of different types. Voltage specifications of batteries of the same shape may vary.
- Replace an exhausted battery with a new one promptly.
- If you will not use the remote control for a long time, remove the batteries.
- If leaked battery fluid gets on your skin or clothing, rinse immediately and thoroughly. If it gets into you eye, bathe your eye well rather than rubbing and seek medical treatment immediately. Leaked battery fluid that gets into your eye or your clothing may cause a skin irritation or damage your eye.
- Do not put the batteries in a place where young children can reach.

DISCLAIMER OF LIABILITY

JVC shall not be liable for any loss relating to the unit's failure to properly record, store or playback any content (video, audio or otherwise) for any reason whatsoever. Any applicable warranties shall only cover replacement or repair of the effected unit, and shall not apply to recovery or replacement of lost content.

ATTENTION:

- Using a mobile phone in the vicinity of the unit may cause picture vibration on the TV screen or change the screen to a black back display.
- Some TVs or other appliances generate strong magnetic fields. Do not place such appliances on top of the unit as it may cause picture disturbance.
- When moving the product, press \odot /I to turn off the power, and wait at least 30 seconds before unplugging the power cord. Then, wait at least 2 minutes before moving the product.
- If there is a power outage when using the unit, the recorded data may be erased.
- It is recommended to back up discs which contain important recordings periodically (every few years). As digital signals do not deteriorate, failure to play back or record might arise due to the effects of the disc aging through the years depending on the storage environment.
- Recorded programs and data cannot be restored once the disc or tape is damaged.

- This unit can play back and record only NTSC signals.
- The hard disk is a consumable item. Replacement is recommended after 10000 hours of use (if use in a 25°C environment). For information on maintenance planning and costs, consult your nearest JVC dealer.
- The fan motor is a consumable item. Replacement is recommended after 30000 hours of use (if use in a 25°C environment). For information on maintenance planning and costs, consult your nearest JVC dealer.



If this symbol is shown, it is only valid in the European Union.

HOW TO USE THIS INSTRUCTION MANUAL

- All major sections and subsections are listed in the Table Of Contents on page 5. Use this when searching for information on a specific procedure or feature.
- The  mark signals a reference to another page for instructions or related information.
- Operation buttons necessary for the various procedures are clearly indicated through the use of illustrations at the beginning of each major section.

BEFORE YOU INSTALL YOUR NEW UNIT . . .

- . . . **please read the sections/literature listed below.**
- "Cautions" on page 2
- "IMPORTANT SAFETY INSTRUCTIONS" on page 3 to 4

Contents

Safety Precaution

Contents

Getting Started

Key Features	6
How to Read this Manual	6
Other Precautionary Notes	7
Hard Disk Drive (HDD)	8
SD Cards	8
Discs	9
Precautions on the Use of Discs	11
On-screen Displays	12
Name and Function of Parts	13
Front panel	13
Display window	14
Rear panel	14
Remote control	15

Preparation

Connecting a Monitor	17
Connecting a Video Deck or Other Equipment	18
Connecting an Amplifier	18
Connecting External Devices	19
Connecting the Power Supply	19
Setting and Displaying Date/Time	20

Dubbing/Importing

Dubbing/Importing	23
Dubbing chart	24
Formatting	25
Recording Modes	28
Importing Data to the HDD Using the ONE TOUCH DUBBING Button	29
Importing Data from a BD/DVD to the HDD	30
Importing Data from a USB-compatible Device to the HDD	33
Importing Data from an SD Card to the HDD	35
Importing Data from an i.LINK-compatible Device to the HDD	37
Dubbing a Title from the HDD to a BD/DVD	39
Dubbing Still Images from the HDD	42
Enabling Playback on Other Devices (Finalizing)	44
Copying the Entire Disc	46
Recording Using External Inputs	47

Playing Back

About Playing Back	48
Using Playback Navigation	48
Option menu list	50
Video Playback Operation	51
Playing Videos on a BD/DVD	53
Playing Videos on the HDD	54
Playing Videos on a SD Card	54

Playing Still Images (JPEG)	55
Changing Playback Settings	56
Playback Settings Menu	56
Audio/subtitle settings	56
Playback settings	56
Video settings	57

Editing

Editing	58
Entering Characters	59
Character List	59
Grouping	60
Changing the Title/Group Name	62
Deleting a Title/Group	62
Turning On Title/Group Protection	63
Turning Off Title/Group Protection	64
Creating a Playlist	65
Editing a Thumbnail	66
Editing a Chapter	67
Dividing	69
Delete Scenes	70
Changing the Disc Name	72
Changing the Shooting Date/Time	72
Mode conversion	73

Settings Menu

Changing Settings of this Unit	74
Setting Menu List	74
Setup	75
Playback Setting	76
Record	77
Audio	78
Display	79
Connection	80

Others

Locking the Disc Tray	82
Turning on the Mode Lock	82
Last Function Memory	82
RS-232C Interface (only for SR-HD1500)	83
Command Table	83
Specifications	83
Command	84
Language Code List	94
Country Code List	96
Using the HDMI Consumer Electronics Control (HDMI CEC)	98
Creating a Seamless BD	98
Troubleshooting	99
Specifications	101
Index	102

Key Features

Professional Blu-ray Disc recorder of the high-definition era

Copy videos to a Blu-ray Disc in high-definition from a high-definition camcorder, or down convert the videos and record them onto DVDs, all without the need for a PC. The internal hard disk drive enables for easy editing and dubbing multiple discs.

Compatible with ProHD Camcorder GY-HM700/100 (only for SR-HD1500)

MOV files that are taken in SP mode (*1) using the JVC ProHD Camcorder GY-HM700/100 are compatible with the SR-HD1500, and can be imported into the HDD or dubbed onto discs.

(*1) SP mode : 1280x720/60p, 30p, 24p, 1440x1080/60i

Compatibility with other consumer camcorders

In addition to AVCHD, HDV and DV, JVC Everio file formats are also compatible, and digital dubbing can be done.

Digital interface that allows for camcorder compatibility

This unit is equipped with USB, SD slots and i.Link input terminals for connecting the camcorder.

Create menu-supported Blu-ray discs

Blu-ray discs can be created using the BDMV (with menu) format. BDAV discs can also be created and dubbed according to the intended use. The SR-HD1500 also enable users to use an original image as the background.

Compatible with dual layer 50 GB Blu-ray discs, and records up to 24 hours of full high-definition images in a single disc

This unit is also compatible with high capacity dual layer 50 GB Blu-ray discs, and up to 24 hours (AE mode) of full high-definition images can be recorded in a single disc. Writing to inexpensive LTH discs is also supported.

Authoring menu enables discs to be created and used industrially such as for demonstrations

Disc authoring can be used to create discs for industrial use, such as discs that repeat playback automatically.

Equipped with external control RS-232C terminal (only for SR-HD1500)

This unit is equipped with a RS-232C terminal that allows for external control using a PC.

How to Read this Manual

About this manual

This manual mainly describes operation procedures using the remote control unit buttons.

- The buttons on the remote control unit are indicated as [Button Name].
- The menu items are indicated as "Menu Item".

■ Supplementary remarks in the main text

Memo : States restrictions on the functions or use of this unit.

Note : States precautions to be taken during operation.

☞ : Indicates the page numbers or items to refer to.

Memo:

The displays of operable media are highlighted.

HDD : Hard disk

DVD : DVD

BD : Blu-ray disc

SD : SD card

SDHC : SDHC Card

CD : Music compact disc

JPEG : JPEG (still picture) file disc

The unit illustrations used in this manual are from the SR-HD1500.

Refer to the supplied CD-ROM for the Spain and French GUIDEBOOK.

In order to view the GUIDEBOOK, Adobe® Acrobat® Reader™ or Adobe® Reader® must be installed. Adobe® Reader® can be loaded from Adobe's web site:<http://www.adobe.com/>

Menu operation

Pressing the remote control buttons below calls up the respective menu screens.

- [SET UP], [NAVIGATION], [EDIT], [INFORMATION CORRECT], [DUBBING], [MEDIA MANAGE]
- Press any of the [▲/▼/◀/▶] buttons to move to a specific menu item (yellow item indicated by a small arrow).
- Press the [OK] button to confirm the selection.
- Press the [RETURN] button to return to the previous screen.
- Simple instructions on the operation procedure may be displayed at the bottom of the screen.

Other Precautionary Notes

Copyright protection

This unit supports copyright protection technologies.

Copyrights

- According to the copyright law, video or music data that you store must not be used for purposes other than personal enjoyment without the authorization of the copyright holder.
- This product employs the CPRM technology, and is protected by the proprietary technologies as well as intellectual property rights of the United States and Japan.
Use of the CPRM technology is subject to the approval of Macrovision Solutions Corporation. Unless special authorization is obtained from Macrovision Solutions Corporation, the CPRM is restricted to household and some pay-per-view uses. Do not dismantle or remodel this product. The copyright protection function prevents copyrighted video images from being saved to equipment such as a video recorder. This function may also cause deterioration in the playback picture quality when the data is output to a monitor through a video recorder. This is not a hardware malfunction. To play back copyrighted videos, connect this product directly to the monitor.
- Read and understand fully the terms and conditions of all copyright works before using this unit in the correct manner. Under no circumstances shall JVC take any responsibility for any infringements of copyright caused by the customer when using this unit. The customer shall be responsible for resolving all legal issues regarding to any copyright infringements.

Stored video content and compensation

- For discs containing important video content, backup on a periodic basis (once every few years) is recommended. Although digital signals do not deteriorate, playback or dubbing may fail due to aging of the disc resulting from the storage conditions.
- Recorded data may be lost if power outage occurs while this unit is being used. It is therefore recommended that videos stored on the HDD be dubbed to a BD or DVD as soon as possible in case the HDD breaks down.
- Videos or data stored on a BD/DVD, HDD, or SD card cannot be recovered if the media is damaged.

Disclaimer of compensation for loss or damage of stored video content

Please note that our company will not be liable for compensation of the content or any incidental damages in the event that dubbing or playback cannot be performed properly for some reasons. The same applies during repair of this unit.

Handling precautions

- **Do not use the plug or power point with dust or metallic objects attached to it**
 - Failure to do so may cause short circuit or heating, and result in fire or electric shock.
 - Remove the plug once every half a year, and clean it with a dry cloth.
- **Make use of a power point that allows the power plug to be inserted or removed easily**
 - Make sure that the plug can be removed immediately in case an abnormality is found in the unit.
- **Insert the plug firmly into the power point**
 - Failure to do so may cause short circuit or heating, and result in fire or electric shock.
- **Do not make use of a power voltage other than that specified**
 - Doing so may result in fire or electric shock.
- **Do not insert or remove the plug with wet hands**
 - Doing so may result in electric shock.
- **Do not touch the plug when there is thunder or lightning**
 - Doing so may cause electric shock.
- **Do not insert any foreign object into this unit**
 - Doing so may result in fire or electric shock.
- **Do not dismantle or remodel this unit**
 - This unit consists of high-voltage components. Dismantling or remodeling the unit may cause fire or electric shock.
- **Request the authorized dealer to inspect the interior part of the unit once a year**
 - Using this unit with dust accumulated inside may result in fire.
 - It is particularly effective to perform servicing before the humid rainy season.
- **Do not connect any video cameras that are not made by JVC to the USB terminal**
 - Doing so may result in malfunction.

Hard Disk Drive (HDD)

Hard disk drive (HDD)

The HDD rotates at a high speed whenever the power is turned "On".

Pay particular attention to the following precautions when using this unit.

Warning

- Do not subject it to vibration or strong impact
Subjecting this unit to excessive impact may result in loss of recorded data and even damage of the HDD.
- Do not remove the power plug when this unit is running
Shutting down the power when the HDD is running may result in data loss and even damage of the HDD. Make sure that the power plug is removed only after turning off the power. (Wait for the "GOODBYE" message on the display window to disappear first)

SD Cards

Precautions for handling SD and SDHC cards

Note:

- The disc operation display icon appears blinking and "READING" is displayed on the display window when the SD card is being accessed (such as during dubbing, playback, or formatting). When access to the SD card is in progress, do not remove the card or the power plug. Doing so may cause the SD card to become unusable.
If the SD card is not usable, reformat the card. If the problem persists even after reformatting, use a new SD card.
- Do not use or store the card at a place that is subject to static or electrical noise.
- Inserting the SD card incorrectly may cause this unit or the card to malfunction.
- Our company will not be liable for any damage or loss of the stored data due to accidents. (Be sure to back up the data.)
- Use the card according to the prescribed conditions. Do not use it at the following locations.
 - Places that are exposed to direct sunlight
 - Places near heat-generating equipment
 - Inside a car that is under the sun with the windows tightly shut
 - Places that are subject to high humidity and corrosion
- Do not bend or drop the card, or subject it to strong impact or vibration.
- Do not expose the card to water.
- Do not place near devices that emit strong magnetic or radio waves.
- Do not touch the metal part of the card.

Memo:

- To dispose a card after erasing all data inside, it is recommended that this be done using a commercially available data deletion software, or by destroying the card physically, such as with a hammer. Formatting or deletion of data using this unit only changes the file administration information, and does not erase the data completely.

BD video data

You can erase BD Video data from the SD card as follows.

1 Insert the SD card which has BD video data stored on it, into the [SD SLOT]

Memo:

- The BD video data cannot be erased if the SD card is write-protected. In this case, turn off the write-protect lock before inserting the SD card.

2 Press the [MEDIA MANAGE] button on the remote control unit

3 Select "BD-VIDEO DATA ERASE" from "SD CARD"

- The confirmation screen for erasing the BD video data is displayed.

4 Select "ERASE", and press the [OK] button

- The BD video data will be erased.

Discs

BD recording formats

■ BDAV mode

- Videos can be edited (chapter edit etc) and new videos can be added to the disk. This format is suitable for recording videos.
- MPEG2 with HD quality will be recorded as it is onto the disc. This format has low playback compatibility, but performs well when used for backups.

■ BDMV mode

- Compatible and playable on other BD players. Menu functions similar to those of DVD video mode are also included.
This format performs well for distribution purposes.

DVD recording formats

■ VR MODE

- Format the disc using “VR MODE” if you want to add new videos to the disc.
- Deleting currently saved videos increases the remaining space on the disc. (except for the case of DVD-R discs.)

■ VIDEO MODE

- Format the disc in this mode if you want to play the disc on a different DVD player.

Formatting of discs

Formatting is required for some disc types. Perform formatting if this is necessary.

■ When using BD-RE or BD-R discs

Formatting is required. Format the disc using this unit.

■ When using DVD-R discs

Formatting is required depending on the disc mode to be used.

- Formatting is required when the disc is used in “VR MODE” . Format the disc using this unit.
- Formatting is not required when using the disc in “VIDEO MODE”.

Note:

- BD-R and DVD-R discs cannot be reformatted. Check the disc mode before formatting the disc.

■ When using DVD-RW discs

Formatting is required. Format the disc using this unit.

- Format using “VR MODE” or “VIDEO MODE”.

Discs (Continued)

Discs that enable both dubbing and playback

Disc Type	Recording Format	Format	Finalize	Repeated Use (Reformat)
BD-RE	BDAV mode	○	-	○
	BDMV mode	○	-	○
BD-R	BDAV mode	○	○	-
	BDMV mode	○	-	-
DVD-RW	Video mode	○	○	○
	VR mode	○	○	○
DVD-R	Video mode	-	○	-
	VR mode	○	○	-

Discs that enable playback only

Disc Type	Description
DVD-RAM (4.7 GB)	Supports specific forms of playback, but no recording can be done.
BD-ROM	Commercially available Blu-ray discs (movies, music, etc.) The region code that can be played back on this unit is "A".
DVD video	Commercially available DVD-Video discs (movies, music, etc.) The region code that can be played back on this unit is "1". The video format used is NTSC.
Music CD	CD-DA DTS music CDs are also playable.

Memo:

- If 8 cm discs are used, only playback can be performed. The disc cannot be used for recording or editing.
- 8 cm discs can be used without adapters.
- DVD-RAM cartridges and BD-RE are not supported. Take the DVD-RAM out of the cartridge before using it.

Discs that are not supported

- DVD-RAM (2.6 GB/5.2 GB)
- DVD-R (for authoring)
- CD-ROM/R/RW (PhotoCD, CD-G, VCD etc.)
- DDCD (1.3 GB, Double Density CD)
- HDCD (High Density CD)

Memo:

- To playback a BD or DVD that was created using this unit on another player, finalize the disc.
- There is no need for finalizing if the BD-RE disc is recorded using BDAV mode.
- If a DVD that was recorded using VR mode has been finalized, the disc can only be played back on VR mode compatible devices.
- To perform high-speed dubbing, make use of a disc that supports high-speed recording.
- This unit can play back and record only NTSC signals.

Note:

- Do not use disc if the sticker or label is peeled off from the disc surface, if the disc is not round in shape, or if it is significantly warped or cracked.

Precautions on the Use of Discs

Maintenance of discs

- Dirt attached to the disc, such as fingerprints and dust, may cause distortion in the video image or sound. Keep the disc clean at all times such as by using a soft cloth.
- Wipe the disc lightly from the center outward using the cloth.
- If dirt is stubborn, wipe it off using a slightly wet cloth, followed by a dry cloth.
- Do not use thinner, benzine, alcohol, conventional record cleaners, or antistatic sprays. Doing so may damage the disc surface.

Handling discs

■ Removing a disc

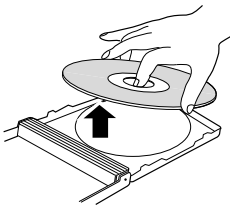

■ Keeping a disc

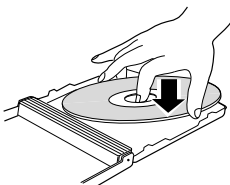

■ Correct way to hold a disc



- Make sure that your hands do not touch the recording/playback side of the disc.

Disc storage

- Avoid storing the disc at the following locations.
 - Places that are subject to high humidity, dust, or mold growth
 - Places that are exposed to direct sunlight or near a heater
 - Inside a car during summer
- Do not drop the disc or subject it to strong impact.
- Place the disc in a case and store it vertically.
- Stacking the discs without using a case, placing the discs against one another or dropping them may result in deformation or cracking.

When the recording/playback lens is dirty

Dust or dirt may be attached to the recording/playback lens after using this unit for a prolonged period of time, and recording or playback may not be properly performed as a result.

Although the performance of this unit varies according to the frequency of use and installation environment, it is recommended that cleaning of the lens be performed once every half a year using commercially available DVD lens cleaners.

For cleaning procedures, refer to the instruction manual of the lens cleaner.

Precautions when playing a dual disc

The side of the dual disc that is not used for DVD recording does not comply with the standard specifications of music CDs.

It is recommended that playback on this unit be limited to the DVD recording side of the dual disc.

Use genuine JVC discs

The best performance may not be obtained for some discs. It is recommended that genuine JVC discs be used to ensure the best results.

Power Cable

Do not unplug the cable during recording or playback. Doing so may cause the disc to become unusable. If the disc becomes unusable, refer to the following.

BD-R or DVD-R : Use a new disc.

BD-RE or DVD-RW : Reformat the disc after erasing the data. If the disc is still not usable, use a new disc.

Do not turn off the [⏻/⏪] button or unplug the power cable immediately after closing the disc tray.

On-screen Displays

Status display

Displays the current settings and operating status (such as playback, pause) of this unit.

Pressing the [ON SCREEN] button on the remote control displays the status. To cancel the display, press the [ON SCREEN] button again.

You can select whether to display the statuses by changing the settings in the settings menu.

For more details, refer to "Display" (☞ page 79) .

Memo:

- To display the statuses, set the ON SCREEN GUIDE item on the DISPLAY menu screen to "AUTO".
 - Setting the DISPLAY item to "OFF" hides display of all status information.
-

Event display

An on-screen event display appears on the display window as well as the monitor when there is a misoperation.

- The event display appears for an interval of about three seconds.

Memo:

- The same event display may appear several times.
-

Alarm display

When an operation is not accepted by this unit, an on-screen alarm display appears on the display of the main unit as well as the monitor.

Name and Function of Parts

Front panel

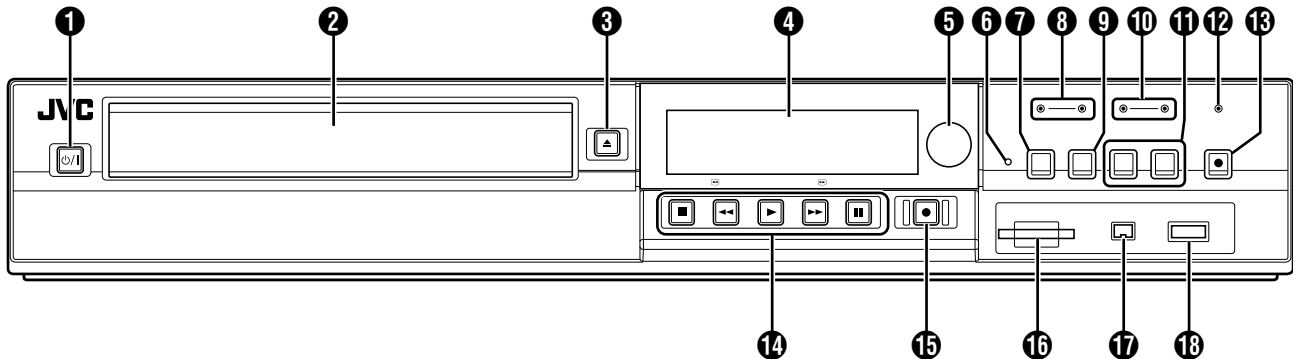

1 [O/I] button

Turn On/Off the power.

2 Disc tray

Opens/closes the disc tray.

3 [\blacktriangle] button

Opens/closes the disc tray.

4 Display window

Remote control sensor

6 [RESET] switch

Reset the unit.

7 [REC MODE] button

Switches the recording mode.

8 [HDD] lamp

Lights up when in HDD mode.

The [REC] lamp lights up while recording/importing.

9 [INPUT SELECT] button

Switches the external input signals (HDV/DV, L1).

10 [BD] lamp

Lights up when in BD/DVD mode.

The [REC] lamp lights up while recording/dubbing.

11 [MEDIA SELECT] button

Switches between HDD and BD/SD.

12 [SD] lamp

Lights up when in SD mode.

13 [ONE TOUCH DUBBING] button

Starts dubbing at a single touch.

14 Playback control buttons

- [\blacktriangleright] button

Plays back the data.

- [\blacksquare] button

Stops playback/recording.

- [\blacktriangleleft] button

Fast reverses playback.

- [\blacktriangleright] button

Fast forwards playback.

- [\parallel] button

Pauses playback.

15 [\bullet] button

Starts recording of a title.

16 [SD SLOT]

Used for inserting SD cards.

17 [i.LINK(HDV/DV IN)] terminal

Connect a video camera using i.LINK (HDV/DV. IN).

18 [USB] terminal

Connect a video camera using USB.

Name and Function of Parts (Continued)

Display window

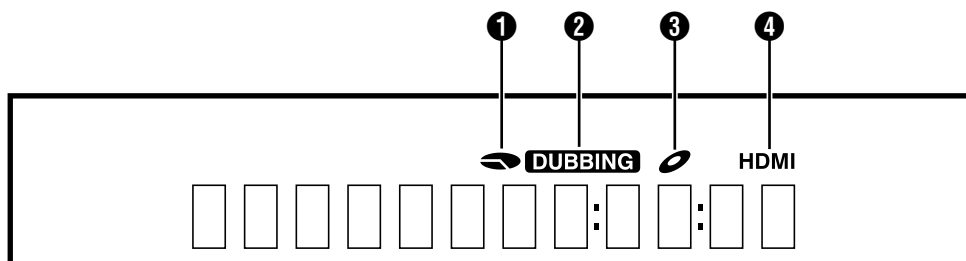

- ❶ HDD/DISC remaining level display
- ❷ Dubbing display
- ❸ Disc status display
- ❹ HDMI output display

Memo:

- The brightness of the display window can be adjusted.

For more details, refer to "PANEL DISPLAY BRIGHTNESS" (page 75).

English messages appear for a number of operations.
(Examples)

HELLO : When the power plug is inserted

READING : When reading the disc

ONSCREEN : Upon moving to the playback navigation screen

Rear panel

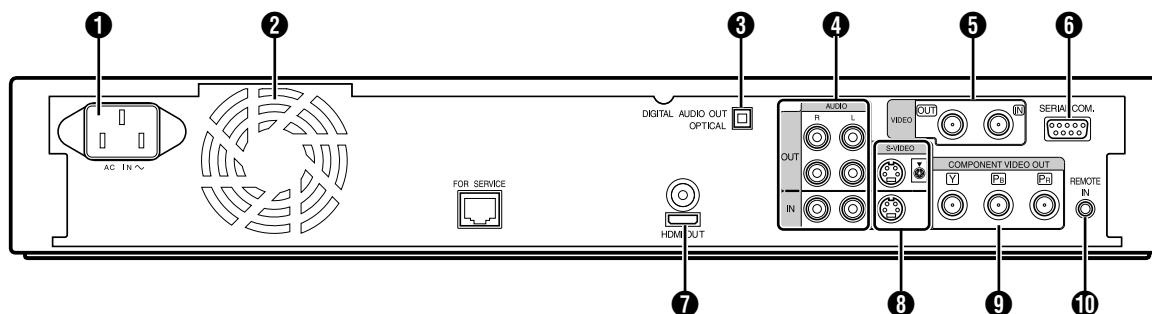

- ❶ AC inlet
For connecting the power supply.
- ❷ Cooling fan
- ❸ [DIGITAL AUDIO OUT (OPTICAL)] terminal
For connecting to the amplifier using an optical audio cable.
- ❹ [AUDIO OUT/IN] terminals
For connecting using an audio cable.
- ❺ [VIDEO OUT/IN] terminals
For connecting using a video cable.

- ❻ [SERIAL COM.(RS-232C)] terminal
(only for SR-HD1500)
For connecting to a computer using a serial cable.
- ❼ [HDMI] terminal
For connecting using an HDMI cable.
- ❽ [S-VIDEO OUT/IN] terminals
For connecting using an S-video cable.
- ❾ [COMPONENT VIDEO OUT] terminals
For connecting using a component video cable.
- ❿ [REMOTE IN] terminal
For connecting a wired remote control.

Remote control

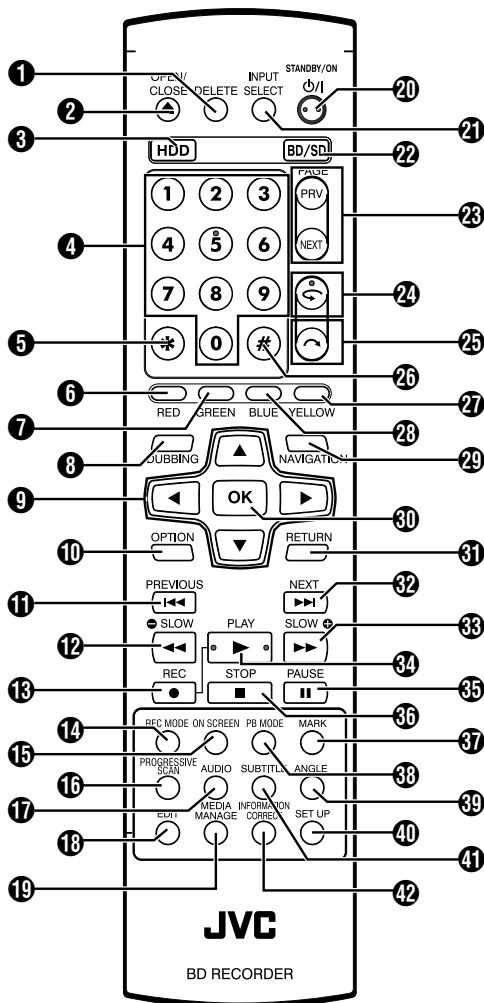
**1 [DELETE]**

Deletes a title or characters.

2 [▲]

Opens/closes the disc tray.

3 [HDD]

For operating the HDD.

4 [1]-[9]

For entering characters.

5 [*]

For entering characters.

6 [RED]

Enabled when the color button (red) is displayed.

7 [GREEN]

Enabled when the color button (green) is displayed.

8 [DUBBING]

Displays the dubbing menu screen.

9 [▲/▼/◀/▶]

The cursor can be moved to select an item.

10 [OPTION]

Displays the option screen.

11 [◀◀]

Move to the chapter just before the current chapter.

12 [◀◀]

Fast reverses the video and starts slow playback.

13 [●]

Press the [●] and [▶] buttons together to start recording.

14 [REC MODE]

For checking the recording mode settings and amount of time remaining.

15 [ON SCREEN]

Displays information on the screen.

16 [PROGRESSIVE SCAN]

Switches the resolution of the image output.

17 [AUDIO]

Switches the playback audio.

18 [EDIT]

Displays the editing menu screen.

19 [MEDIA MANAGE]

Displays the media management menu screen.

20 [⏻/⏻]

For turning On/Off the power.

21 [INPUT SELECT]

Switches the external input signals (HDV/DV, L1).

22 [BD/SD]

For operating BD/DVD or SD.

23 [PAGE PRV][PAGE NEXT]

Returns to the previous page. Or advances to the next page.

24 [↶]

Move the playback position slightly backwards.

25 [↷]

Advance the playback position slightly.

26 [#]

For entering characters.

27 [YELLOW]

Enabled when the color button (yellow) is displayed.

28 [BLUE]

Enabled when the color button (blue) is displayed.

29 [NAVIGATION]

Displays the playback navigation screen.

30 [OK]

Confirms a selection or entry.

31 [RETURN]

Returns to the previous screen without applying the selection or entry.

32 [▶▶]

Move to the next chapter.

Name and Function of Parts (Continued)

33 [>>>]

Fast forwards the video and starts slow playback.

34 [▶]

Plays the video.

35 [||]

Pauses the video that is currently playing.

36 [■]

Stops playback/recording.

37 [MARK]

Adds a chapter mark during playback or recording. Select multiple titles from the playback navigation screen or other screens.

38 [PB MODE]

Display the playback settings screen.

39 [ANGLE]

Switches the camera angle for playback.

40 [SET UP]

Displays the settings menu screen.

41 [SUB TITLE]

Switches the playback subtitle.

42 [INFORMATION CORRECT]

Displays the information editing screen.

Change batteries for the remote control

- If the operable distance of the remote control unit becomes shorter, this means that the batteries are running out. When this occurs, replace the batteries with new ones.

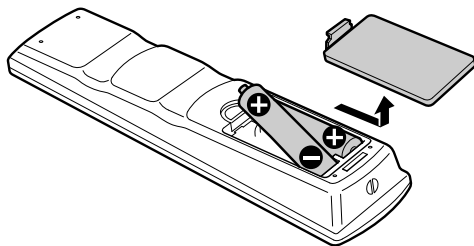

Batteries

- Insert the batteries correctly according to the + and - signs. Insert the - side of the battery first.
- If an error occurs while using the remote control unit, remove the batteries, wait for about five minutes, and operate the remote control unit again after re-inserting the batteries.

Battery life : Approximately 6 months
(depending on the frequency of use)

Remote control codes

By setting a remote control code for the unit and remote control, you can prevent two recorders from operating simultaneously using the remote control for this unit. (the setting for the unit and remote control at time of purchase is "REMOTE CONTROL 3".)

Memo:

- Changing the remote control code for the remote control before the unit's remote control code is changed will cause the unit to be inoperable. Change the unit's remote control code first when changing remote control codes.

■ Changing the remote control code for the unit

- 1 Press the [SET UP] button on the remote control to display the "SETUP" menu
- 2 Change the "REMOTE CONTROL CODE" option in the "SETUP" menu

Memo:

- For more details, refer to "REMOTE CONTROL CODE" (page 75).

■ Changing the remote control code for the remote control

- 1 Press and hold the [OPTION] button on the remote control
- 2 Press either of the [1], [2], [3] or [4] buttons
 - Press the number button that is equivalent to the remote control code you desire.
- 3 Press the [OK] button
 - Press the [OK] button to change the remote control code.
- 4 Release the [OPTION] button on the remote control

Memo:

- If the remote control code is different from the unit, the remote control code for the unit will be displayed on the display window.

Examples: REMOTE CONTROL 3

Connecting a Monitor

To display video images from this unit, connect it to a monitor.

- This unit supports connections using “HDMI cable”, “component video cable”, “S-video cable”, or “video cable”.

Memo:

- Switch to the appropriate monitor input according to the type of connection cable used.
For details, refer to the instruction manual of the monitor.

Connecting using a HDMI cable

Connecting using a HDMI cable (sold separately) enables signals to be maintained in the digital format, and thus playback of clear video images.

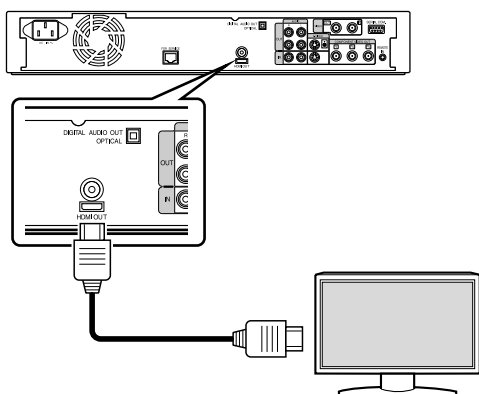

Memo:

- Videos cannot be displayed on a monitor that does not support the copyright protection system (HDCP).
- Use a High Speed HDMI Cable.
- After connecting using a HDMI cable, change the unit setting to “HDMI CONNECTION”.

For more details, refer to “VIDEO PRIORITY MODE” (page 80).

Connecting using a component video cable

Connecting using a component video cable (sold separately) delivers playback images that are clearer than those by an S-video cable.

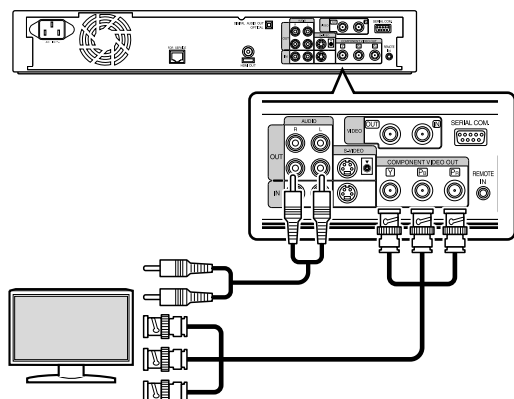

Memo:

- After connecting a component video cable, change the unit setting to “COMPONENT OUTPUT”.

For more details, refer to “COMPONENT OUTPUT” (page 81).

Connecting using an S-video cable

Connecting using an S-video cable (sold separately) delivers video images that are clearer than those by a video cable.

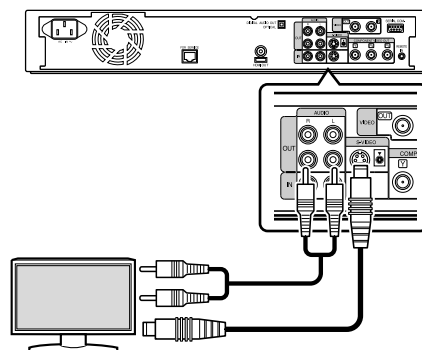

Connecting using a video cable

Connect the output terminal of this unit to the input terminal of a TV using the supplied video/audio cable. (Use the supplied BNC adapter)

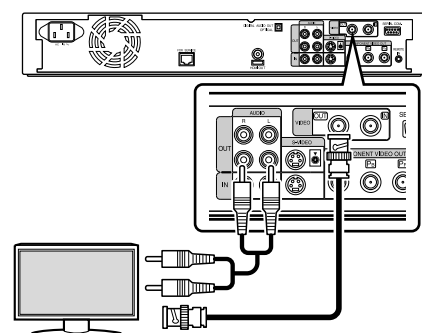

Note:

- Connect the S-video/video output of this unit directly to the TV (or monitor). Connecting this unit to the TV or monitor via a video deck triggers the copy protection function, and may cause distortion in the video images during playback.

Connecting a Video Deck or Other Equipment

Connecting a video camera

■ Connecting via the i.LINK terminal

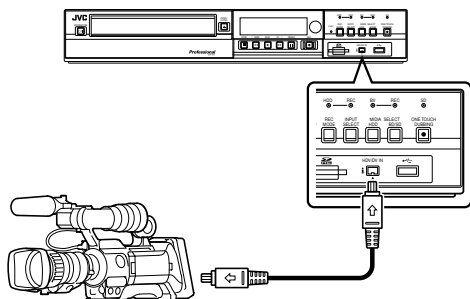

■ Connecting via the USB terminal

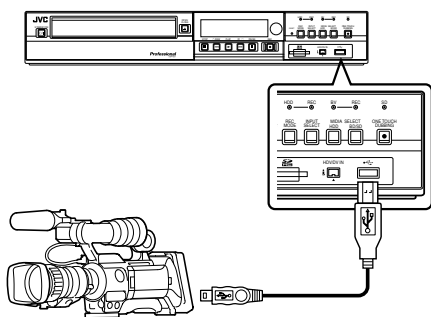

Memo:

- Some video camera models may require an AC adapter instead of batteries to run. For details, refer to the video camera's instruction manual.

Connecting a video deck or other equipment (recording using this unit)

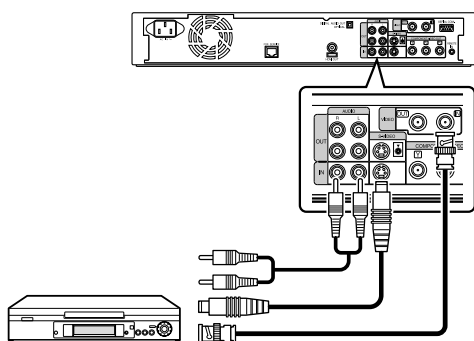

Memo:

- When connecting using an S-video cable, change the setting of "VIDEO INPUT SETTING" to "S-VIDEO".

For more details, refer to "VIDEO INPUT SETTING" (page 81).

- To record video images played back on this unit to an external device (video deck, etc.), connect the output terminal of this unit to the input terminal of the external device.

Connecting an Amplifier

Connecting an audio amplifier

■ Connecting using an optical digital cable

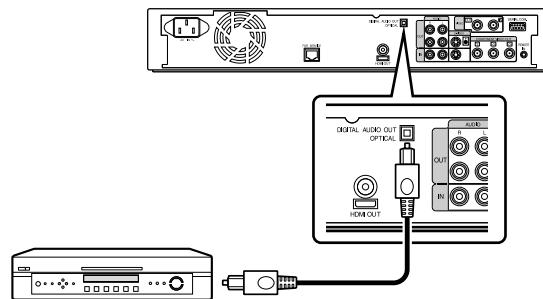

Memo:

- Remove the protection cap of the cable before connecting. Store the protection cap properly to prevent it from being misplaced.

■ Connecting using an audio cable

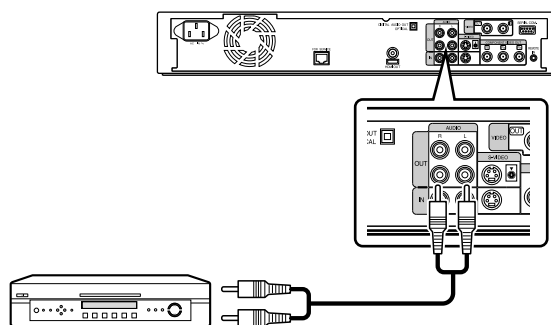

Connecting External Devices

Connecting a wired remote control

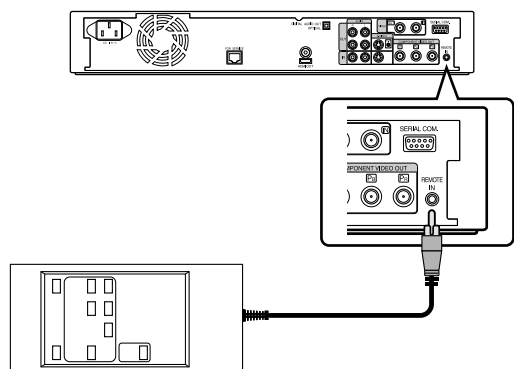

Using a wired connection enables stable control of this unit from an external device.

Operation is possible using any code (1 to 4) regardless of the remote control code settings of this unit.

Memo:

- There is currently no compatible remote control unit available.
- To create a wired remote controller, refer to “RS-232C Interface” (page 83).

Connecting using a RS-232C cable (only for SR-HD1500)

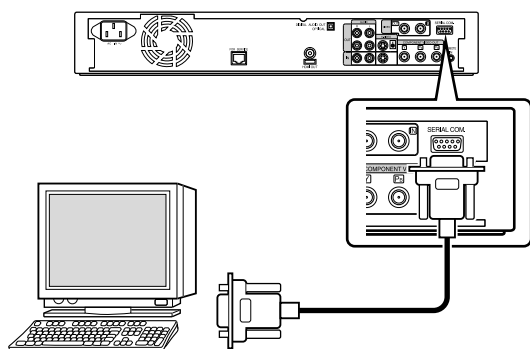

External operation is enabled by connecting a RS-232C cable to a PC or similar device.

For details on external operation, refer to “RS-232C Interface” (page 83).

Connecting the Power Supply

Connect the supplied power cable to this unit as follows.

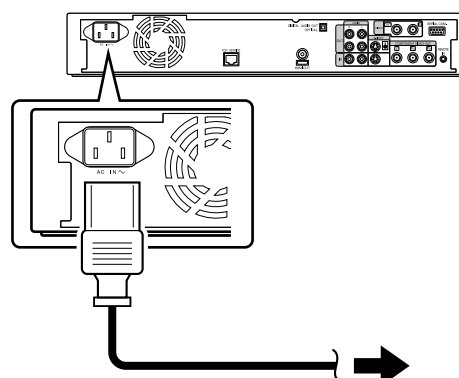

- 1 Connect the supplied power cable to the AC IN terminal of this unit
- 2 Connect the other end of the power cable to a power point
- 3 Press the [⏻/⏻] button on the remote control or this unit to switch on the unit.

• The power of this unit turns on, and a “HELLO” message appears on the display window.

Note:

- Do not use power cables other than that supplied with this unit. Doing so may cause this unit to malfunction.

Setting and Displaying Date/Time

Set the date/time of the built-in clock as follows. The recording date/time is stored on the disc.

Setting the date/time

Set the date/time of the built-in clock as follows.

1 Press the [SET UP] button on the remote control unit

- The Settings menu screen appears.

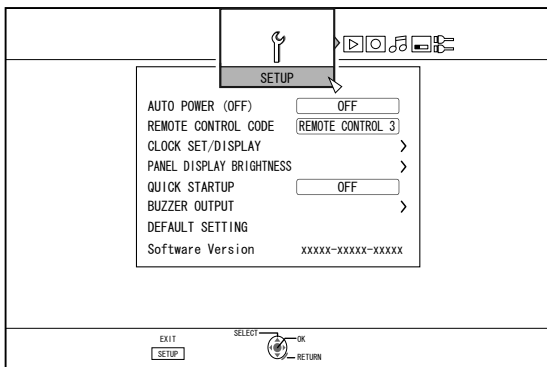

2 Select "SETUP", and press the [OK] button

3 Select "CLOCK SET/DISPLAY", and press the [OK] button

- "CLOCK SET/DISPLAY" menu screen appears.

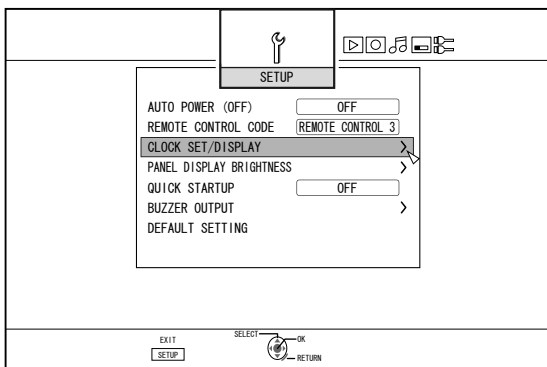

4 Select "CLOCK SET", and press the [OK] button

- The Clock Set menu screen appears.

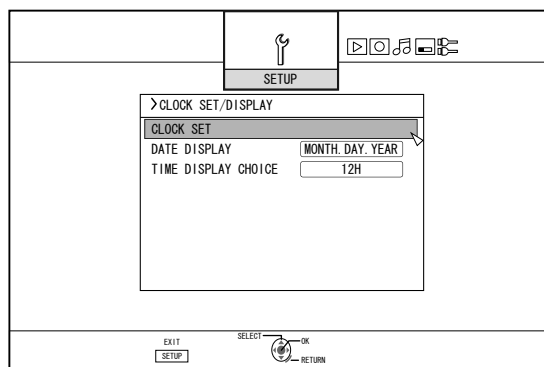

5 Set the time and date

- Repeat the steps below to specify the time and date.

① Press the [▲] or [▼] button, select the Clock Set item, and press the [OK] button.

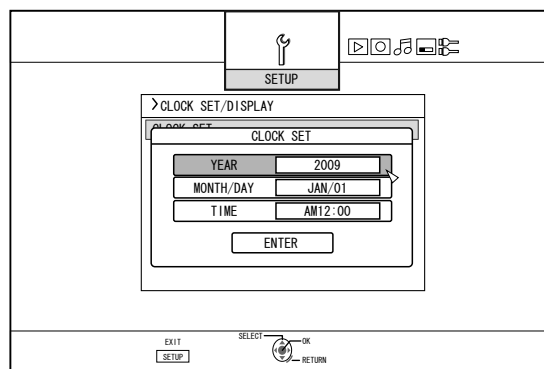

② Press the [▲] or [▼] button, change the setting value, and press the [OK] button.

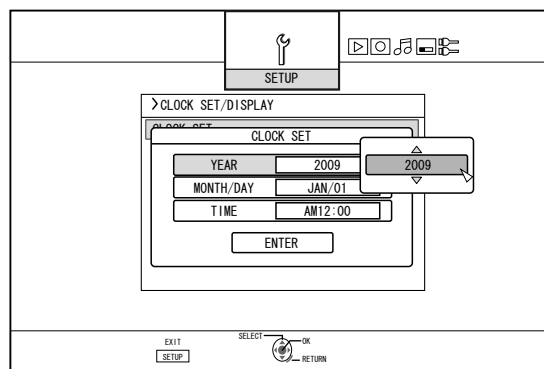

6 After setting is complete, select “ENTER”, and press the [OK] button

- Doing so exits date/time setting, and returns to the initial screen.

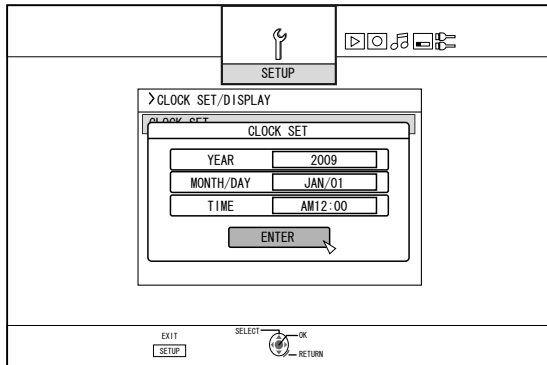

Memo:

- The value for seconds cannot be set. After setting the minute, press the [SET UP] button according to the time signal.
- To cancel date/time setting, press the [RETURN] button. Doing so cancels date/time setting and returns to the initial screen.
- The year can be set from 2009 to 2037.
If "2037.12.31 PM11:59" is set, the time will change to "2009.1.1 AM00:00" after one minute.

Changing the date display style

You can specify the display style of the date as follows.

- 1 Press the [SET UP] button on the remote control unit
 - 2 Select “SETUP”, and press the [OK] button
- The Settings menu screen appears.

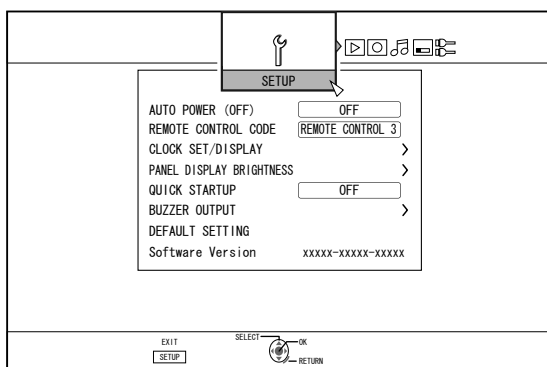

3 Select “CLOCK SET/DISPLAY”, and press the [OK] button

- The Clock Set/Display menu screen appears.

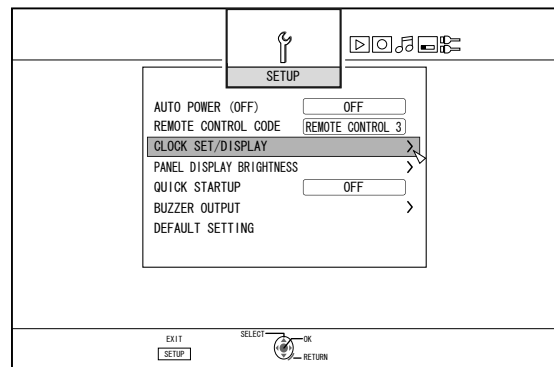

4 Select “DATE DISPLAY”, and press the [OK] button

- The Date Display menu screen appears.

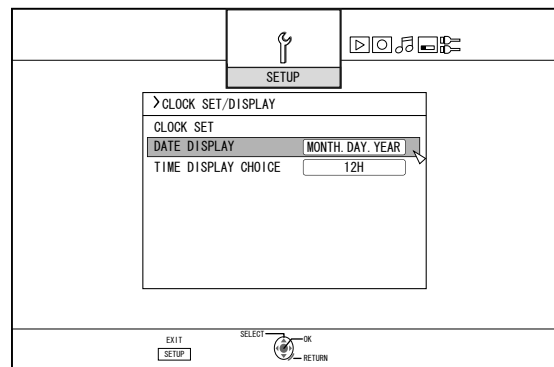

5 Select the date display style.

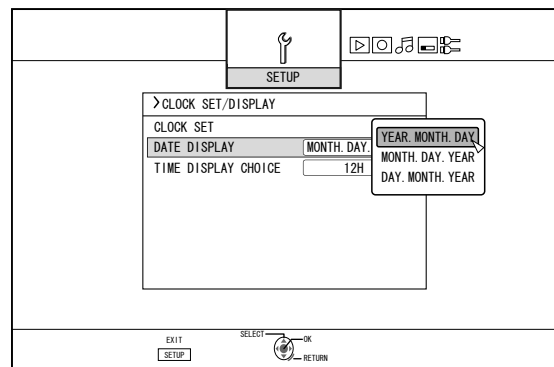

- Select a date display style from the following items.
 - YEAR.MONTH.DAY : Displays the date in the year/month/day order.
 - MONTH.DAY.YEAR : Displays the date in the month/day/year order.
 - DAY.MONTH.YEAR : Displays the date in the day/month/year order.

6 After selecting, press the [OK] button

- The date display style will be saved.

Setting and Displaying Date/Time (Continued)

Memo:

- The date display style will be applied in the following information displays.
 - Recording date of the title that is shown in the playback navigation screen (The recording date will be shown in place of the title if the title has not been input).
 - Shooting date and time that is shown when AVCHD is played back
 - Date that is displayed in the title information display screen

Changing the time display style

You can specify the display style of the time as follows.

1 Press the [SET UP] button on the remote control unit

2 Select “SETUP”, and press the [OK] button

- The Settings menu screen appears.

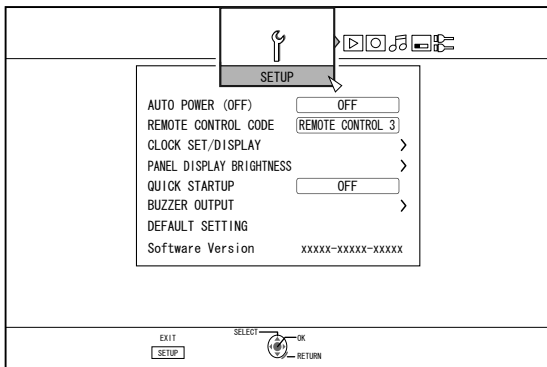

3 Select “CLOCK SET/DISPLAY”, and press the [OK] button

- The Clock Set/Display menu screen appears.

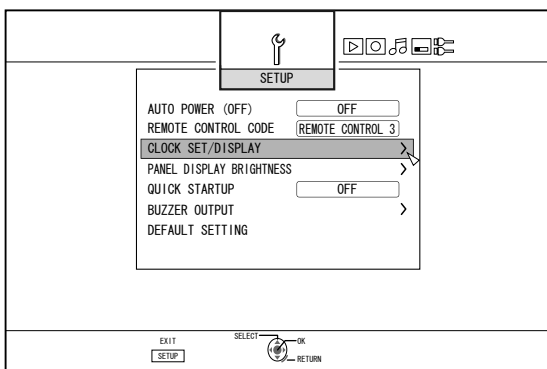

4 Select “TIME DISPLAY CHOICE”, and press the [OK] button

5 The Time Display menu screen appears

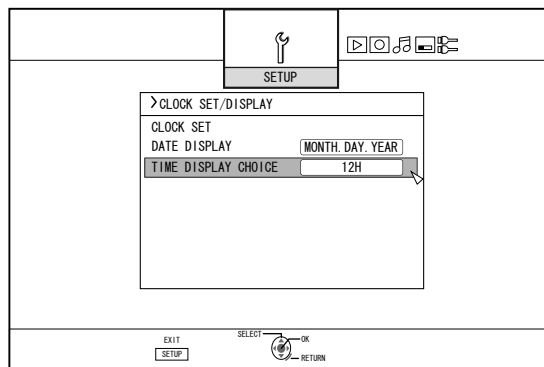

6 Select the time display style

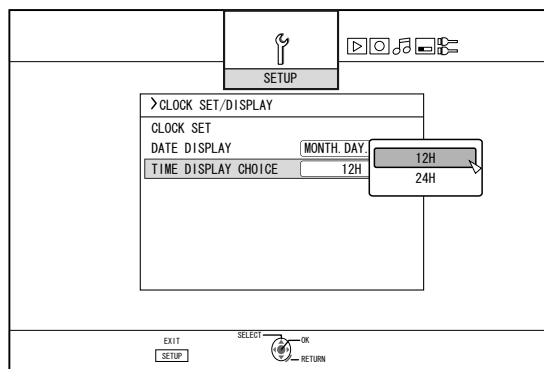

Select from “12H” or “24H”.

12H: Displays the time in AM/PM format.

24H: Displays the time in 24-hour format.

7 After selecting, press the [OK] button

- The time display style will be saved.

Memo:

- The time display style applies to the following.
 - Current time
 - Date/time registered on the disc
 - Recording time of the title that is shown in the playback navigation screen (The recording time will be shown in place of the title if the title has not been input.)
 - Shooting date and time that is displayed when AVCHD is played back
 - Time of recording that is displayed in the title information display screen

Dubbing/Importing

Bi-directional dubbing between the HDD and a BD/DVD is possible using this unit alone. Also, data can be imported to the HDD from a video camera by connecting it via i.LINK or USB.

Dubbing from the HDD to a BD/DVD

High-speed dubbing

Select this option if you want to significantly shorten the time required for dubbing. Make use of a BD/DVD disc that supports high-speed recording.

Dubbing in a specific recording mode

Select this option when you want to specify the recording mode for dubbing. Dubbing can be performed in the recording mode of your preference, such as whether to “maintain a high picture quality” or “save as many titles as possible”.

For more details, refer to “Recording Modes” (page 28).

Memo:

- The image quality will not improve even when a recording mode with image quality higher than that of the original recording mode is chosen.
- Dubbing using a specific recording mode will cause the disc to be re-encoded.

Other options for importing data into the HDD

Importing data from a BD/DVD to the HDD

You can import titles from a BD/DVD.

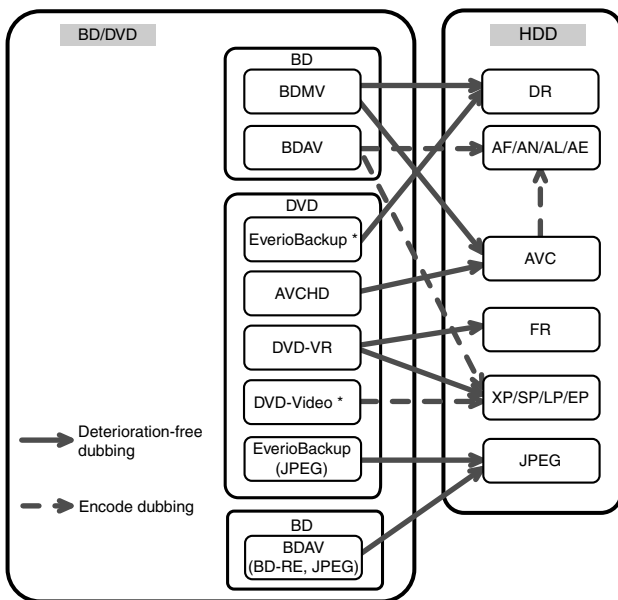

- DVD-video* : Discs that are not finalized cannot be imported.
- EverioBackup* : Data disc containing high-definition videos that are recorded in the MPEG2 format using a DVD writer for Everio.

Importing data from a SDHC/SD to the HDD

Videos captured using a video camera can be imported to the HDD by inserting the SDHC/SD card that the videos are saved on.

Importing data from a video camera to the HDD

Videos captured using a video camera can be imported to the HDD.

This unit supports video camera connections via i.LINK and USB.

Memo:

- For MOV format videos, only videos in MOV format (SP mode) taken using JVC ProHD camcorder GY-HM700/100 are compatible. There is no guarantee for importing videos taken on devices by other company. In addition, MOV videos cannot be imported using the SR-HD1250.

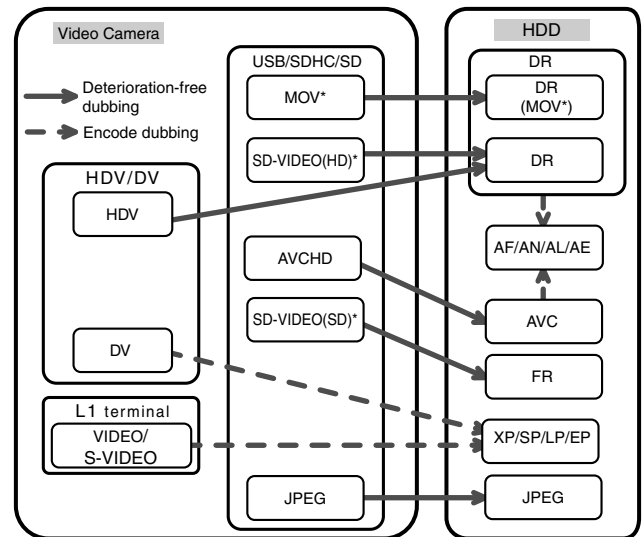

- MOV* : MOV files that are taken in SP mode using the JVC ProHD Camcorder GY-HM700/100
- SD-VIDEO(HD)* : SD-VIDEO(JVC Everio MPEG2 TS)
- SD-VIDEO(SD)* : SD-VIDEO(JVC Everio MPEG2 PS)

Importing data from a video deck

You can import data to the HDD from an external video deck by connecting it to a composite video or S input terminal. For more details, refer to “Recording Using External Inputs” (page 47).

Memo:

- Videos that are copy-controlled cannot be imported.
- Motion JPEG is not supported

Dubbing/Importing

Dubbing chart

■ Dubbing the video data from the HDD

Content Quality \ Dubbing Quality	Format (BD)			Format (DVD)	
	BDMV(HD Quality)	BDAV(HD Quality)	BDAV(SD Quality)	DVD-VR	DVD-VIDEO
DR (MOV*)	High-speed dubbing	High-speed dubbing / Re-encoding	Re-encoding	Re-encoding	Re-encoding
DR (Other)	-	High-speed dubbing / Re-encoding	Re-encoding	Re-encoding	Re-encoding
AF/AN/AL/AE	High-speed dubbing	High-speed dubbing / Re-encoding	Re-encoding	Re-encoding	Re-encoding
AVC	High-speed dubbing	High-speed dubbing / Re-encoding	Re-encoding	Re-encoding	Re-encoding
FR	-	-	Re-encoding	High-speed dubbing / Re-encoding	Re-encoding
XP/SP/LP/EP*	-	-	Re-encoding	High-speed dubbing / Re-encoding	High-speed dubbing / Re-encoding

Memo:

- EP* : High-speed dubbing to DVD-VIDEO format discs in EP mode title
 To perform high-speed dubbing of a EP mode title to a DVD-VIDEO format disc, set "HIGH-SPEED DUBBING" (page 77) in the settings menu to "4:3" before recording or importing. Only re-encoding will be performed when dubbing a title that is recorded or imported with a setting other than "4:3".
- MOV* : MOV files that are taken in SP mode using the JVC ProHD Camcorder GY-HM700/100

■ Dubbing the picture data from the HDD

Importing file (HDD)	Media	
	BDAV(BD-RE)	SDHC/SD
JPEG	○	○

Memo:

- Video images may be distorted in the following situations during reencoding/dubbing when the monitor (TV) is connected to this unit using a HDMI cable, or when the screen resolution is set to 1080p.
 - Proceeding with dubbing from the menu screen
 - Returning to the normal screen after dubbing has finished
- This is not a malfunction. Change the screen resolution to a setting other than 1080p if you feel that this is annoying.

Formatting

Unused discs or SD cards may require formatting in some cases.

When the need arises, format the disc or SD card accordingly.

Memo:

- Formatting a disc or SD card erases all existing data from the media.
Double-check carefully before formatting so as not to erase important titles.
- When using a DVD-R disc in the Video mode, formatting is not required.

Format chart

Refer to the following chart for the disc types and format when formatting a disc.

Note:

- If a disc is formatted using an equipment not manufactured by JVC, the disc may not be read correctly even though it corresponds to the chart below.
In this case, reformat the disc using this unit, or make use of another blank disc.

Memo:

- BD-R and DVD-R discs can only be formatted once.
- When a disc is re-formatted into another format, remove the disc and load it again.

■ DVD format chart

	Format	VR Format	Video Format
DVD-RW	Single-sided, single layer (4.7 GB)	○	○
DVD-R	Single-sided, single layer (4.7 GB)	○	○(*)
	Single-sided, dual layer (8.5 GB)	○	○ (*)

- : Format supported.
- * : Formatting not required.

■ BD format chart

		Format
BD-RE	Single-sided, single layer (25 GB)	○
	Single-sided, dual layer (50 GB)	○
BD-R	Single-sided, single layer (25 GB)	○
	Single-sided, dual layer (50 GB)	○

- : Format supported.

Formatting a disc

- 1 Set the DVD or BD to be formatted on the disc tray
- 2 Press the [MEDIA MANAGE] button on the remote control unit
 - The Media Management menu screen appears.

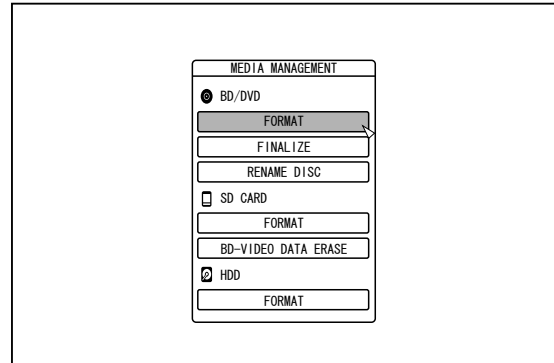

3 Select "FORMAT" from "BD/DVD"

- DVD : A format selection screen appears.
- BD : A confirmation screen to execute formatting appears.

4 Select a format mode from the format selection screen

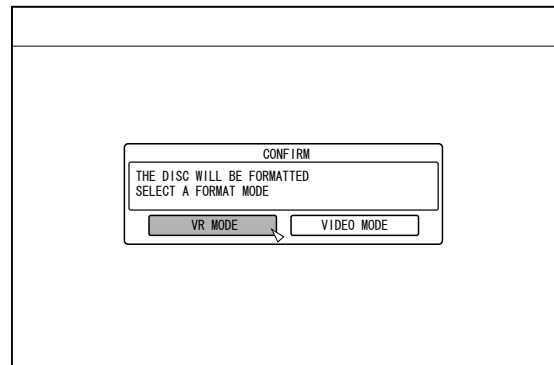

- DVD-RW : Select a "Format mode" from "VR MODE" or "VIDEO MODE".

Memo:

- This screen does not appear when a BD or DVD-R disc is used.

Formatting (Continued)

- 5 Select “YES”, and press the [OK] button in the format confirmation screen

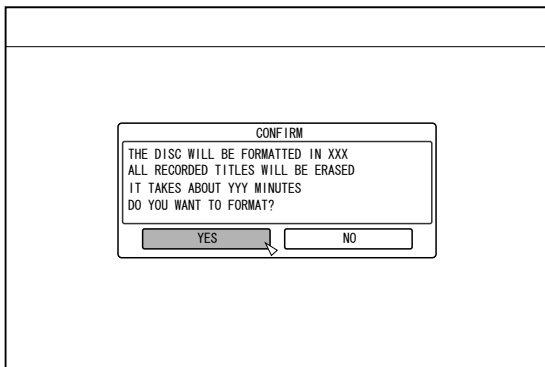

- Formatting starts.
- After formatting is complete, a “THE DISC HAS BEEN FORMATTED” message appears on the monitor, and the normal screen is displayed.

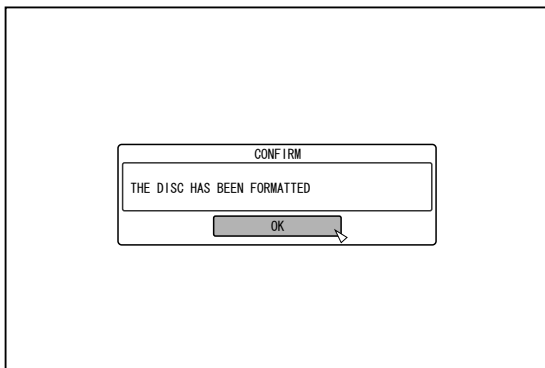

Memo:

- To return to the initial screen without formatting the disc, select “DO NOT FORMAT” and press the [OK] button. Alternatively, you can press the [RETURN] button to return to the initial screen without formatting.

Note:

- Do not turn off the power or unplug the power cable when the “FORMATTING DISC...” message is displayed.
- Note that formatting a disc with copyright-protected titles erases all the titles from the disc.

Cancel formatting

- 1 Press the [OPTION] button while formatting

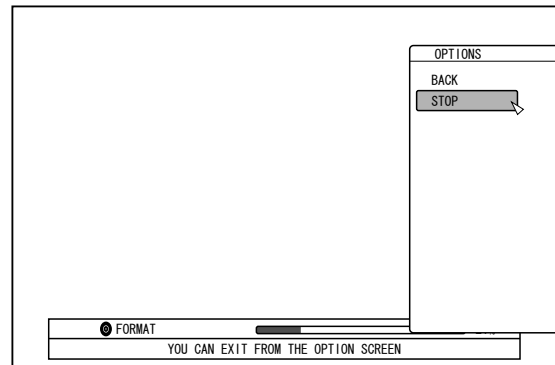

- 2 Select “STOP” and press the [OK] button

- A confirmation screen to stop formatting appears.

- 3 Select “YES” on the confirmation screen and press the [OK] button

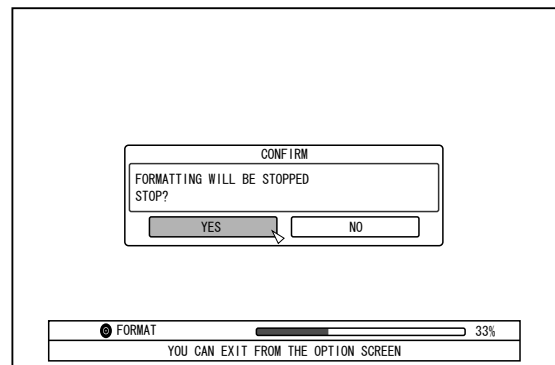

- Formatting is stopped.

Note:

- Formatting can be stopped if it seems to take a long time (more than two minutes).
- If for any reason formatting cannot be stopped, the confirmation screen for stopping formatting will not appear even if the [OPTION] button is pressed.

Formatting an SD Card

1 Insert the SD card to be formatted into the [SD SLOT]

- With the terminal side facing down, insert the SD card until a “click” sound is heard.

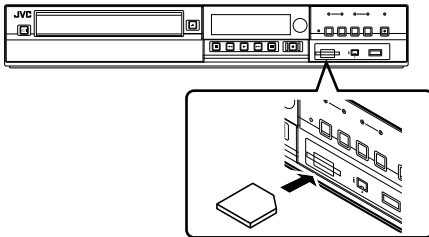

Note:

- Formatting cannot be performed if the SD card is write-protected. In this case, turn off the write-protect lock before inserting the SD card.

2 Press the [MEDIA MANAGE] button on the remote control unit

- The Media Management menu screen appears.

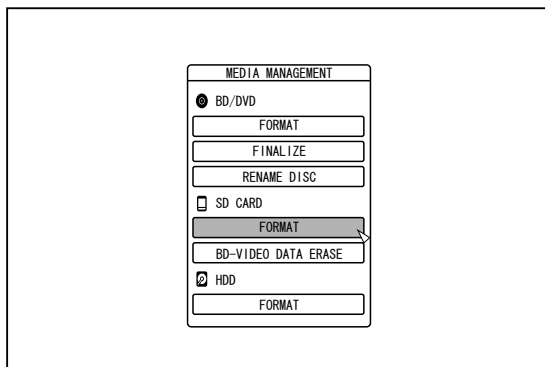

3 Select “FORMAT” from “SD CARD”

- A confirmation screen to execute formatting appears.

4 Select “YES”, and press the [OK] button

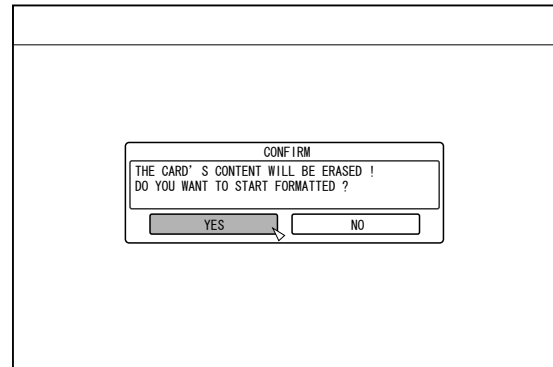

- Formatting starts.
- After formatting is complete, a “THE SD CARD HAS BEEN FORMATTED” message appears on the monitor, and the normal screen is displayed.

Memo:

- To return to the initial screen without formatting the disc, select “NO” and press the [OK] button. Alternatively, you can press the [RETURN] button to return to the initial screen without formatting.

Note:

- Do not turn off the power or unplug the power cable when the “FORMATTING SD CARD...” message is displayed. Do not remove the SD card as well. Doing so may damage the SD card.
- Note that formatting a disc with copyright-protected titles erases all the titles from the disc.
- Once the formatting of the SD card begins, it cannot be stopped.

Recording Modes

Maximum recording time for each recording mode

You can specify a recording mode according to the intended use. Setting the video to a high picture quality shortens the maximum recording time, while setting to a lower picture quality lengthens the recording time.

Refer to the following table for the maximum recording time in the respective modes. All figures shown in the table are approximate values.

Recording Mode	Quality	BD (Single-sided, Single Layer)	BD (Single-sided, Dual Layer)	DVD (Single-sided, Single Layer)	DVD (Single-sided, Dual Layer)	HDD (500 GB) (*1)
DR	HD	-	-	-	-	40 hours (*2)
AF		4 hours	8 hours	-	-	80 hours
AN		6 hours	12 hours	-	-	126 hours
AL		9 hours	18 hours	-	-	189 hours
AE		12 hours	24 hours	-	-	252 hours
XP	SD	5.25 hours	10.5 hours	1 hours	1.7 hours	110 hours
SP		10.5 hours	21 hours	2 hours	3.5 hours	222 hours
LP		21 hours	42 hours	4 hours	7.1 hours	442 hours
EP		42 hours	84 hours	8 hours	14.3 hours	887 hours

*1 : If the HDD capacity is 250 GB (SR-HD1250US model) the time will be approximately half of what is stated here.

*2 : An estimated figure when HDV is imported.

Memo:

- DR mode
Abbreviation for Direct Recording. Videos are recorded in the original picture quality.
- AF/AN/XP/SP mode
Recommended for recording images with fast motion, such as sports videos.
 - The AF/AN mode record images at the high-quality HD level.
 - The XP/SP modes record images at the high-quality SD level.
- AL/AE/LP mode
Recommended for recording images with slow motion and little contrast, such as dramas.
 - AL/AE mode records images at the low-quality HD level.
 - LP mode records images at the low-quality SD level.
- EP mode
Recommended for recording images with sharp outlines, such as animation videos, and when the recordable time (remaining time) is limited.

HD picture quality

- Using BD enables dubbing to be done with HD picture quality. To dub HD picture quality titles that are imported in the HDD, use BD.

Note:

- Dubbing to a DVD cannot be done in HD picture quality.

DR mode

- HDV, MOV* and SD-VIDEO(JVC Everio MPEG2 TS) titles are imported using DR mode.

MOV* : MOV files that are taken in SP mode using the JVC ProHD Camcorder GY-HM700/100

FR mode

FR mode is displayed as the recording mode in the following cases.

- FR mode during import into HDD
During import of SD-VIDEO (JVC Everio MPEG2 PS) titles via high-speed dubbing. During import of data via high-speed dubbing from DVD-VR discs recorded using other units.
- FR mode during dubbing from HDD
When selecting the most appropriate mode automatically between XP and EP according to the remaining memory on the disc.

Importing Data to the HDD Using the ONE TOUCH DUBBING Button

Titles can be imported to the HDD from an SD card or device connected to the USB or i.LINK terminal simply by pressing the [ONE TOUCH DUBBING] button.

- File formats that can be imported
 - USB connection device, SD card**
AVCHD, SD-VIDEO(JVC Everio MPEG2 TS, PS), MOV*, and JPEG
MOV* : MOV files that are taken in SP mode using the JVC ProHD Camcorder GY-HM700/100
 - i.LINK-connected device**
DV and HDV content

Memo:

- Data is searched according to the order of priority listed below when multiple devices are connected to this unit.
USB ⇒ SD card ⇒ i.LINK
Data is retrieved only from the first device and imported to the HDD. Connect only the device that contains data you want to import to the HDD.
The i.LINK connected device can only be used to import from tape media.
- All video files (scenes) imported using "ONE TOUCH DUBBING" are combined into one title.
This unit does not support combining of titles during the editing operation after import is complete. To combine and import data, select "ONE TOUCH DUBBING".
- Titles of two or more scenes cannot be combined if the recording criteria, such as video size, are different.
- Import of MOV files recorded using JVC GY-HM700/100 SP mode 1080i (25 Mbps) requires a duration that is about 1.3 times longer than the usual time.
- When importing DV contents with shooting date/time information, the date/time information at the beginning of the contents will be taken as the shooting date/time information. For HDV contents or DV contents without shooting date/time information, the importing date/time will be taken as the shooting date/time information.

Note:

- Do not unplug the cable while importing to the HDD is in progress. Doing so may result in loss or damage of the titles.
- For MOV format videos, only videos in MOV format (SP mode) taken using JVC ProHD camcorder GY-HM700/100 are compatible. There is no guarantee for importing videos taken on devices by other company.
In addition, MOV videos cannot be imported using the SR-HD1250.
- Only titles that are not copyright-protected can be imported.
- Recognizing the device and importing the files may take a long time depending on the amount of files in the device or media.

■ Procedure for one-touch importing

1 Connect the device to be used. Alternatively, insert an SD card.

- Once preparations for importing have been done, the message below will be shown on this unit's display window.

i.LINK device : "HDV/DV RDY"
USB device : "USB RDY"
SD card : "SD RDY"

2 Press the [ONE TOUCH DUBBING] button on the unit

- One-touch importing starts.

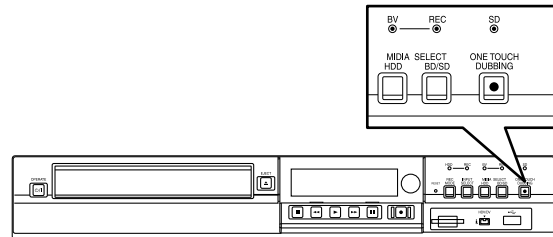

Memo:

- Refer to the following for the flow of operations by the system of this unit.

3 System checks the device connection

- The system of this unit detects the connected device. Search for devices is performed in the sequence of USB, SD card, followed by i.LINK.

4 System detects the titles to import

- All titles that can be imported will be detected and imported.

5 Importing of titles by this unit starts

6 After titles are successfully imported, a "DUBBING IS COMPLETED" message appears on the monitor

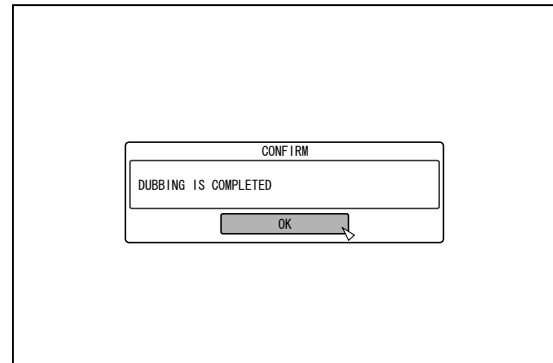

Memo:

- The following buttons are enabled when importing is in progress.

[⏻/⏹] : Continues importing while switching this unit to the Standby mode.

[ONE TOUCH DUBBING] : Press this button for three seconds or longer to cancel importing.

[OPTION] : Displays a pop-up menu for canceling importing.

[ON SCREEN] : Pressing this button each time displays or hides the importing information.

Note:

- Importing stops and a message appears on the monitor if an error occurs during the importing process.

Importing Data from a BD/ DVD to the HDD

Data can be imported from a BD/DVD to the HDD as follows.

- File formats that can be imported
BD-MV, BD-AV, AVCHD, DVD-VR, DVD-VIDEO, EverioBackup, and JPEG

Memo:

- Titles that are imported using “FULL IMPORT” combined into one title.
This unit does not support combining of titles during the editing operation after import is complete. To combine and import data, select “FULL IMPORT”.
- For data that is selected for import via “SEL. TITLE(VIDEO)”, titles with the same date are combined.
- Titles of two or more scenes cannot be combined if the recording criteria, such as video size, are different.

Note:

- Only titles that are not copyright-protected can be imported.
- Recognizing the device and importing the files may take a long time depending on the amount of files in the device.

■ Preparations

- 1 Set a BD or DVD on the disc tray
 - 2 Press the [DUBBING] button on the remote control unit
- The importing screen appears.

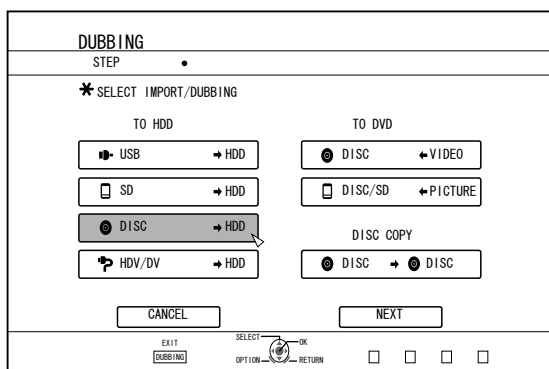

- 3 Select “DISC⇒HDD” in the importing screen, and press the [OK] button

- A check mark is added to the “DISC⇒HDD” item.

- 4 Select “NEXT”, and press the [OK] button

- The import selection screen appears.

Memo:

- A recording mode selection appears instead of the import selection screen when DVD-VIDEO is detected.
For more details, refer to “Importing DVD-VIDEO” (page 32).

Full import

- 1 Select “FULL IMPORT” in the import selection screen, and press the [OK] button

- A check mark is added to the “FULL IMPORT” item.

- 2 Select “NEXT”, and press the [OK] button

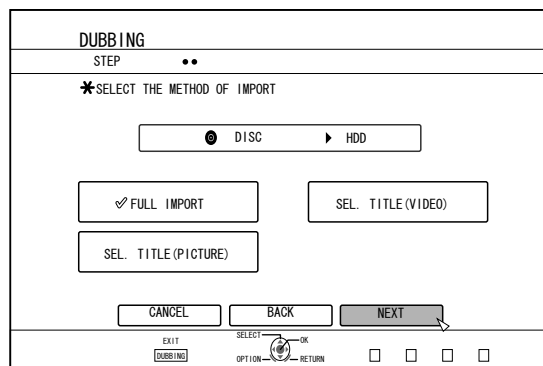

- “START” will appear instead of “NEXT” in the menu if the disc is of a format other than “BD-AV”. In this case, go to Step 5.

- 3 Select “RECORDING MODE”, and press the [OK] button

- A pop-up menu appears.

- 4 Select the “RECORDING MODE” option

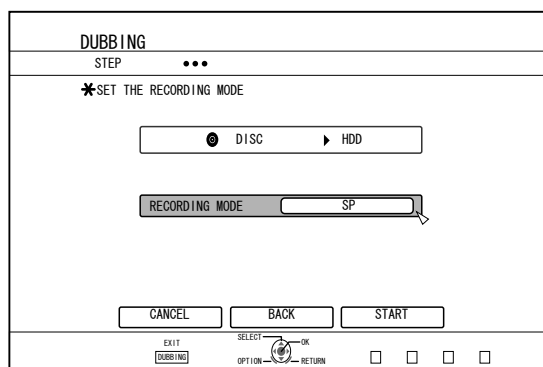

For more details, refer to “Recording Modes” (page 28).

5 Select “START”, and press the [OK] button

- Importing of the titles starts.
- After titles are successfully imported, a “DUBBING IS COMPLETED” message appears on the monitor.

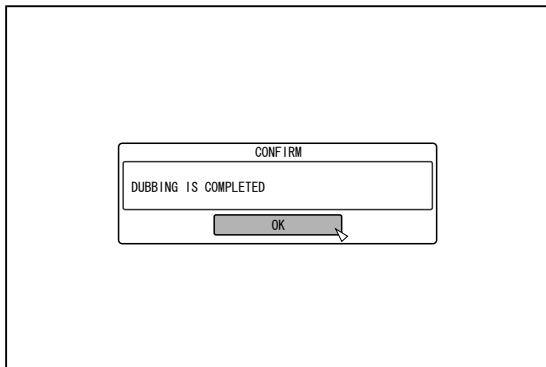

Specify a title

1 Select “SEL. TITLE(VIDEO)” in the import selection screen, and press the [OK] button

- A check mark is added to the “SEL. TITLE(VIDEO)” item.

2 Select “NEXT”, and press the [OK] button

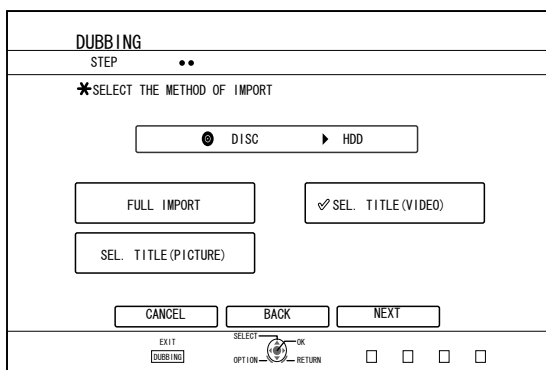

- If a “BD-AV” disc is set, a recording mode selection screen will appear.
- If the disc is of a format other than “BD-AV”, a screen for creating an import title list will appear. Go to step 5.

3 Select “RECORDING MODE”, and press the [OK] button

- A pop-up menu appears.

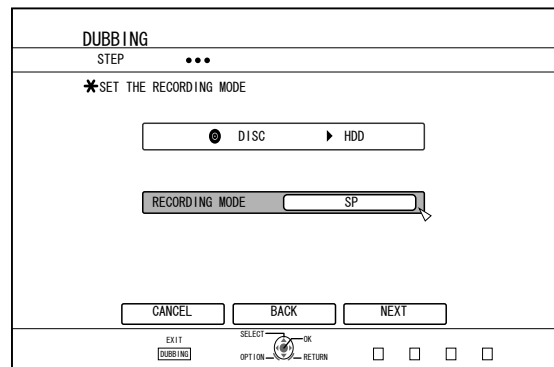

4 Select the “RECORDING MODE” option.

For more details, refer to “Recording Modes” (page 28) .

5 Select “NEXT”, and press the [OK] button

- A screen for creating the import title list appears.

6 Create an import title list

- Follow the steps below to create an import title list.

① Select “ADD TITLE LIST FOR DUBBING”, and press the [OK] button

The Title List screen is displayed.

② Select the titles to import, and press the [OK] button

Titles selected are added to the list.

Memo:

- Press the [MARK] button. A check mark will appear beside the title.
All titles with a check mark can be added to the list at the same time.
- Select a title from the dubbing title list, and press the [OK] button to perform the following changes.
 - Delete the selected title from the list
- Thumbnails may not be displayed during title selection depending on the discs used.

Importing Data from a BD/ DVD to the HDD (Continued)

7 Select "START", and press the [OK] button

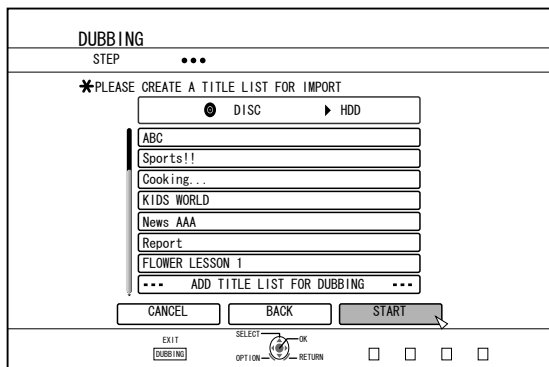

- Importing of titles starts according to the sequence in the created title list.
- After titles are successfully imported, a "DUBBING IS COMPLETED" message appears on the monitor.

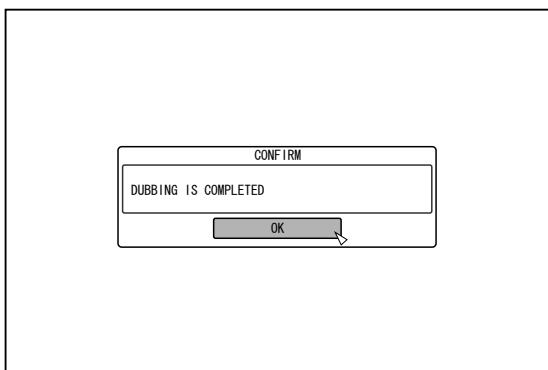

Note:

- "START" cannot be selected for the following cases.
 - A title that cannot be dubbed has been selected
 - HDD memory is insufficient
 - The amount of titles in the HDD has reached the maximum amount
 - A dubbing title list has not been created

Importing DVD-VIDEO

When DVD-VIDEO is detected, a recording mode selection screen appears. Follow the steps below to import DVD-VIDEO to the HDD.

1 Select "RECORDING MODE", press the [OK] button, and select "RECORDING MODE" from the recording mode selection screen

- Select the "RECORDING MODE" option.

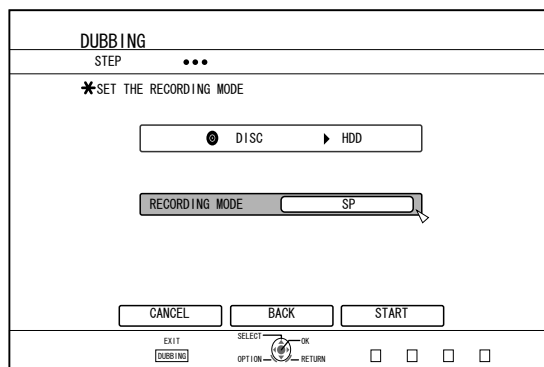

For more details, refer to "Recording Modes" (page 28).

2 Select "START", and press the [OK] button

- Importing of the titles starts.
- After titles are successfully imported, a "DUBBING IS COMPLETED" message appears on the monitor.

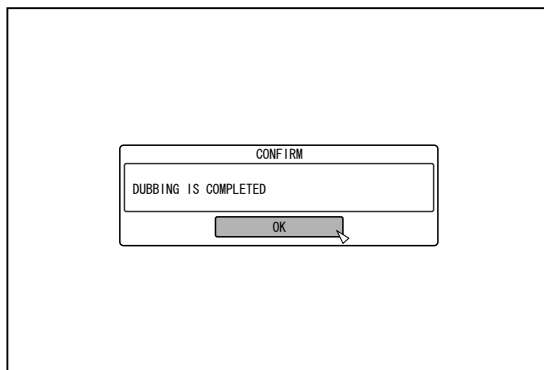

Memo:

- If the first play setting of the DVD-video has been set to top menu or other settings, the title will not playback. If playback does not start, press the play button or playback the DVD-Video.

Canceling importing

■ To cancel importing before it starts

- Select "CANCEL" from the menu, and press the [OK] button to cancel importing of a title.
- Alternatively, you can press the [RETURN] button to cancel importing and return to the initial screen.

■ To cancel importing while it is in progress

- Press the [OPTION] button to display the pop-up menu. Select "CANCEL" from the pop-up menu and press the [OK] button. Data will be written onto the disc up to the point where import is cancelled.
- Importing will also be stopped when the [■] button is pressed to stop playback.

Importing Data from a USB-compatible Device to the HDD

Data on devices connected to the USB terminal can be imported to the HDD as follows.

- File formats that can be imported
AVCHD, SD-VIDEO(JVC Everio MPEG2 TS, PS), MOV*, and JPEG
- MOV* : MOV files that are taken in SP mode using the JVC ProHD Camcorder GY-HM700/100

Memo:

- Titles that are imported using "FULL IMPORT" combined into one title. This unit does not support combining of titles during the editing operation after import is complete. To combine and import data, select "FULL IMPORT".
- For data that is selected for import via "SEL. TITLE(VIDEO)", titles with the same date are combined.
- Titles of two or more scenes cannot be combined if the recording criteria, such as video size, are different.
- Import of MOV files recorded using JVC GY-HM700/100 SP mode 1080i (25 Mbps) requires a duration that is about 1.3 times longer than the usual time.

Note:

- Turn off the power for this unit and the connecting device if an USB compatible device is to be connected to this unit.
- Do not unplug the USB cable while importing a title. Doing so may result in loss or damage of the titles.
- Only titles that are not copyright-protected can be imported.
- For MOV format videos, only videos in MOV format (SP mode) taken using JVC ProHD camcorder GY-HM700/100 are compatible. There is no guarantee for importing videos taken on devices by other company. In addition, MOV videos cannot be imported using the SR-HD1250.
- Recognizing the device and importing the files may take a long time depending on the amount of files in the USB device.
- If a USB connection is used, this unit will only recognize one device out of all the recording devices. Depending on the video camera, the memory card slot will be recognized but the internal device will not be recognized. Use the following methods to solve this.
 - If the internal device is not recognized:
Copy the data from the camera's internal memory or HDD onto the SD card.
 - If using a JVC camcorder that has two memory card slots:
Put the memory card that has the required data in slot A.
- If the target device is not recognized using the USB connection, use the camcorder's burner or a similar device to dub the disc before proceeding with dubbing on this unit. For more details, refer to "Importing Data from a BD/DVD to the HDD" (page 30).
- When importing videos from a USB-connected camcorder, data reading from the internal memory of the camcorder may fail. If both the camcorder's internal memory and SD card are available, the SD card may be detected first. To prevent this from occurring, remove the SD card before reading data from the internal memory.

■ Preparations

- 1 Connect the USB device (Everio, etc.) to this unit using a USB cable

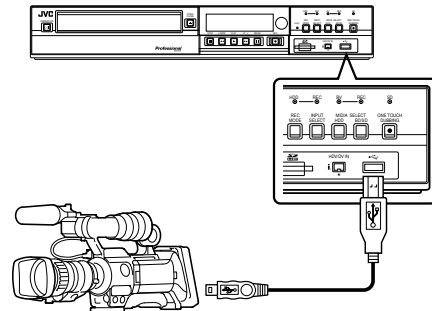

Memo:

- After connecting the USB cable, turn on the camera and switch the mode of the camera. (Choose "Connect to a computer" or a similar option. For details refer to the camera's instruction manual.)
- "USB RDY" appears on the display window of the unit when an USB device is recognized.

- 2 Press the [DUBBING] button on the remote control unit

- The importing screen appears.

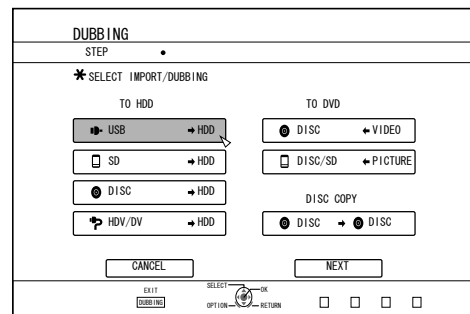

- 3 Select "USB⇒HDD" in the importing screen, and press the [OK] button

- A check mark is added to the "USB⇒HDD" item.

- 4 Select "NEXT", and press the [OK] button

- The import selection screen appears.

Full import

- 1 Select "FULL IMPORT" in the import selection screen, and press the [OK] button

- A check mark is added to the "FULL IMPORT" item.

- 2 Select "START", and press the [OK] button

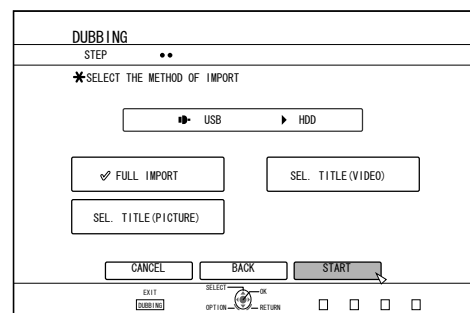

Importing Data from a USB-compatible Device to the HDD (Continued)

- Importing of the titles starts.
- After titles are successfully imported, a “DUBBING IS COMPLETED” message appears on the monitor.

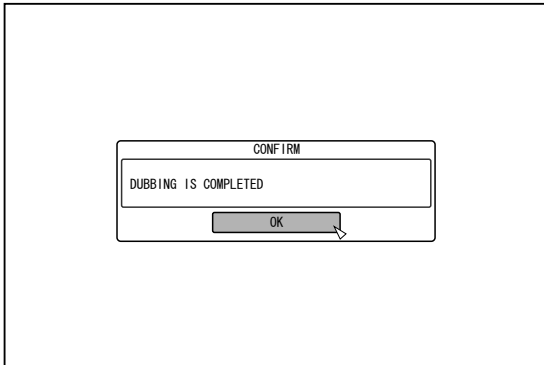

Specify a title

- 1 Select “SEL. TITLE(VIDEO)” in the import selection screen, and press the [OK] button
 - A check mark is added to the “SEL. TITLE(VIDEO)” item.
- 2 Select “NEXT”, and press the [OK] button

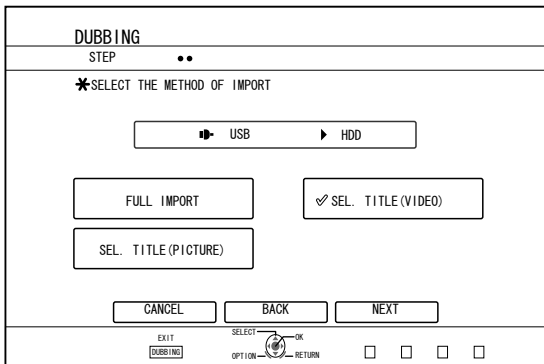

- A screen for creating the import title list appears.
- 3 Create an import title list
 - Follow the steps below to create an import title list.
 - ① Select “ADD TITLE LIST FOR DUBBING”, and press the [OK] button
 - The Title List screen is displayed.
 - ② Select the titles to import, and press the [OK] button
 - Titles selected are added to the list.
- Memo:**
- Press the [MARK] button. A check mark will appear beside the title.
 - All titles with a check mark can be added to the list at the same time.
 - You can perform the following editing operations by selecting a title from the dubbing title list and pressing the [OK] button.
 - Delete the selected title from the list
 - Thumbnails will not be displayed when a title is selected.

- 4 Select “START”, and press the [OK] button

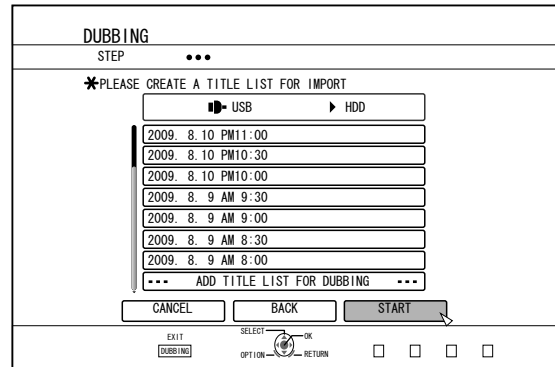

- Importing of titles starts according to the sequence in the created title list.
- After titles are successfully imported, a “DUBBING IS COMPLETED” message appears on the monitor.

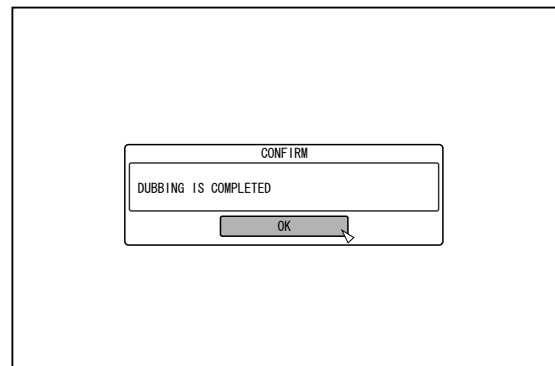

Note:

- “START” cannot be selected for the following cases.
 - A title that cannot be dubbed has been selected
 - HDD memory is insufficient
 - The amount of titles in the HDD has reached the maximum amount
 - A dubbing title list has not been created

Canceling importing

■ To cancel importing before it starts

- Select “CANCEL” from the menu, and press the [OK] button to cancel importing of a title.
- Alternatively, you can press the [RETURN] button to cancel importing and return to the initial screen.

■ To cancel importing while it is in progress

- Press the [OPTION] button. Select “CANCEL” from the Cancel Importing menu, and press the [OK] button. Doing so imports data to the HDD up to the position where you have chosen to stop.

Importing Data from an SD Card to the HDD

Data can be imported from a SD (SDHC) card to the HDD as follows.

- File formats that can be imported
AVCHD, SD-VIDEO(JVC Everio MPEG2 TS, PS), MOV*, and JPEG
- MOV* : MOV files that are taken in SP mode using the JVC ProHD Camcorder GY-HM700/100

Memo:

- Titles that are imported using “FULL IMPORT” combined into one title. This unit does not support combining of titles during the editing operation after import is complete. To combine and import data, select “FULL IMPORT”.
- For data that is selected for import via “SEL. TITLE(VIDEO)”, titles with the same date are combined.
- Titles of two or more scenes cannot be combined if the recording criteria, such as video size, are different.
- Import of MOV files recorded using JVC GY-HM700/100 SP mode 1080i (25 Mbps) requires a duration that is about 1.3 times longer than the usual time.

Note:

- Do not remove the SD card when importing of the titles is in progress or when the importing screen is displayed. Doing so may result in loss or damage of the titles.
- For MOV format videos, only videos in MOV format (SP mode) taken using JVC ProHD camcorder GY-HM700/100 are compatible. There is no guarantee for importing videos taken on devices by other company. In addition, MOV videos cannot be imported using the SR-HD1250.
- Only titles that are not copyright-protected can be imported.

■ Preparations

1 Insert the SD (SDHC) card into the [SD SLOT]

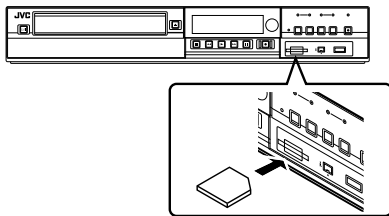

Memo:

- “SD RDY” appears on the display window of the unit when an SD card is recognized.

2 Press the [DUBBING] button on the remote control unit

- The importing screen appears.

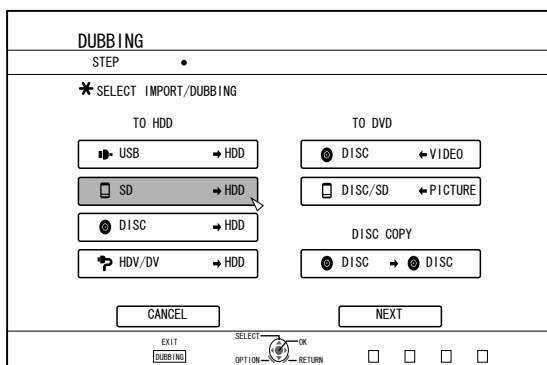

3 Select “SD⇒HDD” in the importing screen, and press the [OK] button

- A check mark is added to the “SD⇒HDD” item.

4 Select “NEXT”, and press the [OK] button

- The import selection screen appears.

Full import

1 Select “FULL IMPORT” in the import selection screen, and press the [OK] button

- A check mark is added to the “FULL IMPORT” item.

2 Select “START”, and press the [OK] button

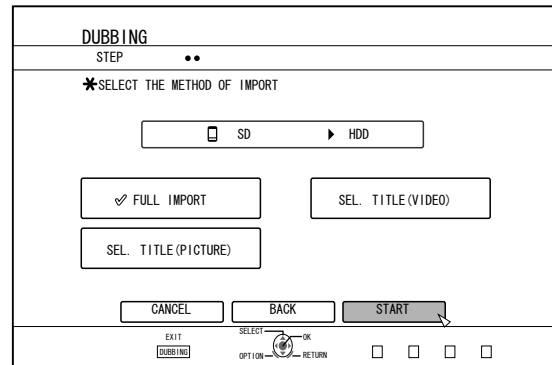

- Importing of the titles starts.
- After titles are successfully imported, a “DUBBING IS COMPLETED” message appears on the monitor.

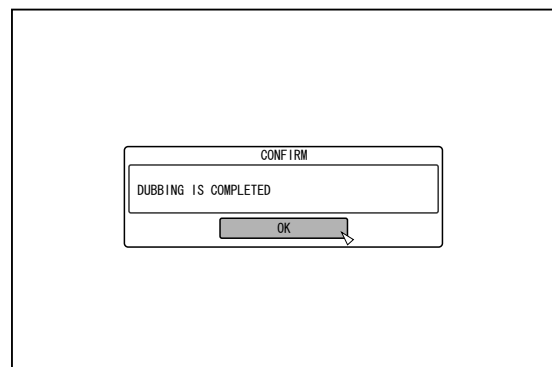

Memo:

- Choose “BACK” from the menu and press the [OK] button to return to the previous screen.

Importing Data from an SD Card to the HDD (Continued)

Specify a title

- 1 Select "SEL. TITLE(VIDEO)" in the import selection screen, and press the [OK] button
 - A check mark is added to the "SEL. TITLE(VIDEO)" item.
- 2 Select "NEXT", and press the [OK] button

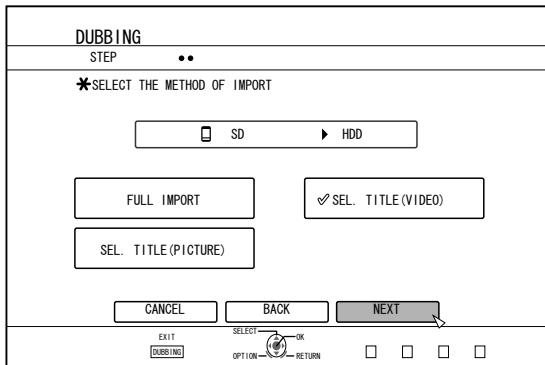

- A screen for creating the import title list appears.

3 Create an import title list

- Follow the steps below to create an import title list.
 - ① Select "ADD TITLE LIST FOR DUBBING", and press the [OK] button

The Title List screen is displayed.
 - ② Select the titles to import, and press the [OK] button

Titles selected are added to the list.

Memo:

- Press the [MARK] button. A check mark will appear beside the title.

All titles with a check mark can be added to the list at the same time.
- You can perform the following editing operations by selecting a title from the dubbing title list and pressing the [OK] button.
 - Delete the selected title from the list
- When there are files of different formats (AVCHD, SD-VIDEO, MOV*) in the SD card, press the [RED] button to select the format you want to display.

MOV*: MOV files that are taken in SP mode using the JVC ProHD Camcorder GY-HM700/100

- 4 Select "START", and press the [OK] button

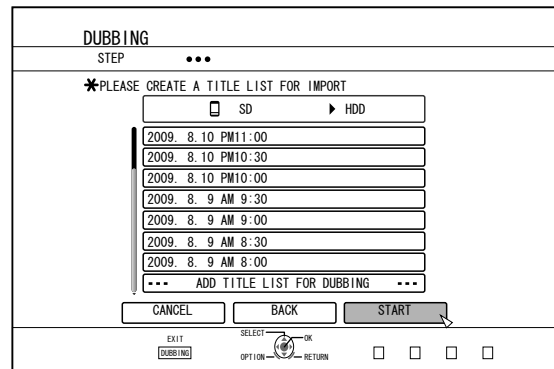

- Importing of titles starts according to the sequence in the created title list.
- After titles are successfully imported, a "DUBBING IS COMPLETED" message appears on the monitor.

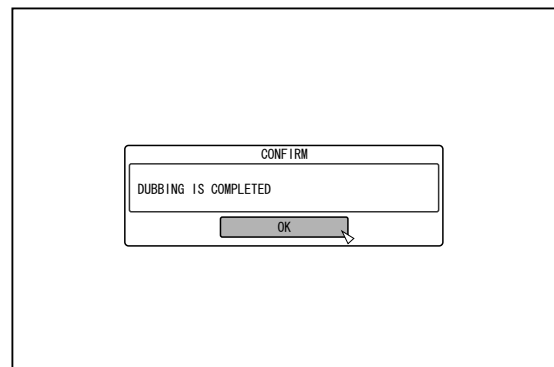

Memo:

- Choose "BACK" from the menu and press the [OK] button to return to the previous screen.

Note:

- "START" cannot be selected for the following cases.
 - A title that cannot be dubbed has been selected
 - HDD memory is insufficient
 - The amount of titles in the HDD has reached the maximum amount
 - A dubbing title list has not been created
- Thumbnails will not be displayed when a title is selected.

Canceling importing

■ To cancel importing before it starts

- Select "CANCEL" from the menu, and press the [OK] button to cancel importing of a title.
- Alternatively, you can press the [RETURN] button to cancel importing and return to the initial screen.

■ To cancel importing while it is in progress

- Press the [OPTION] button. Select "CANCEL" from the Cancel Importing menu, and press the [OK] button. Doing so imports data to the HDD up to the position where you have chosen to stop.

Importing Data from an i.LINK-compatible Device to the HDD

Data on devices connected to the i.LINK terminal can be imported to the HDD as follows.

- Video formats that can be imported:
DV and HDV content

Memo:

- Only titles that are not copyright-protected can be imported.
- Devices that have in-built copyright protection such as D-VHS and digital tuners cannot be connected. This unit only allows import from tape media.
- Importing will not be performed if no tape has been inserted into the HDV/DV camera.
- Importing will be cancelled when the mode is changed from HDV to DV or vice versa.
- For camcorders that support both HDV and DV recording, use only one of the modes for recording and playback.
- There is no support for editing using a connected PC.
- Only one i.LINK device can be connected to this unit at a time.
- When importing DV contents with shooting date/time information, the date/time information at the beginning of the contents will be taken as the shooting date/time information. For HDV contents or DV contents without shooting date/time information, the importing date/time will be taken as the shooting date/time information.

Note:

- Turn off the power for this unit and the connecting device when connecting using an i.LINK compatible device.
- Do not unplug the i.LINK cable while importing to the HDD is in progress. Doing so may result in loss or damage of the titles.
- For example, during full import of HDV content from JVC GY-HD100 via i.LINK connection, the beginning of the image may not be captured if GY-HD100 is not set as follows.
 - (1) Set the [IEEE1394] switch at the rear of the GY-HD100 unit to [HDV] or [DV] according to the recorded content.
 - (2) Set [MENU]/[VIDEO FORMAT]/[PB TAPE] on the GY-HD100 unit to [HDV] or [DV].
(As with (1), set according to the recorded content. Setting to [AUTO] is not allowed.)
 - (3) Check to ensure that the [HDV] or [DV] lamp on the side of the GY-HD100 unit is lit.
(Check to ensure that the lamp that is lit corresponds to the setting in (1) and (2).)
 When importing from a tape that contains data captured in the HDV recording and DV recording modes, change the video camera setting according to each recording mode, check to ensure that the corresponding lamp in (3) is lit, and choose to start import from the current position.

■ Preparations

- 1 Connect the device (camera, etc.) to this unit using an i.LINK cable

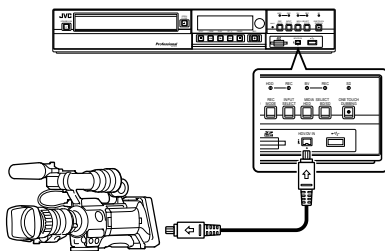

Memo:

- After the device (camera, etc.) has been connected using an i.Link cable, turn on the power of the device and switch it to playback mode. (refer to the device's (camera, etc.) instruction manual for more details.)
- "HDV/DV RDY" appears on the display window of the unit when an i.LINK device is recognized.

- 2 Press the [DUBBING] button on the remote control unit

- The importing screen appears.

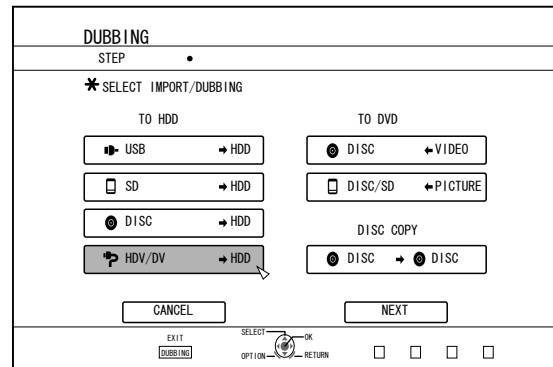

- 3 Select "HDV/DV⇒HDD" in the importing screen, and press the [OK] button

- A check mark is added to the "HDV/DV⇒HDD" item.

- 4 Select "NEXT", and press the [OK] button

- The import selection screen appears.

Imports data from the beginning

You can import videos from the beginning till the end as follows. If the current position is halfway through the tape, import after rewinding the tape to the beginning.

- 1 Select "IMPORT FROM BEGINNING", and press the [OK] button

- A check mark is added to the "IMPORT FROM BEGINNING" item.

- 2 Select "NEXT", and press the [OK] button

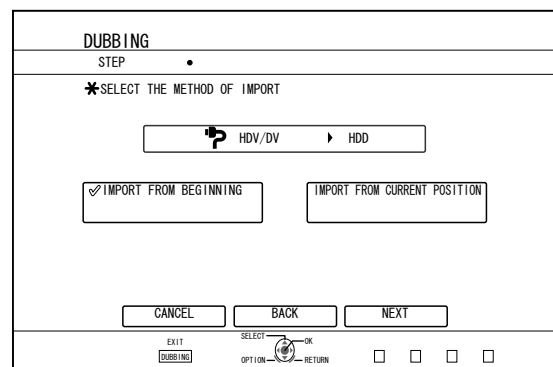

- A recording mode selection screen appears.

- 3 Select "RECORDING MODE", press the [OK] button, and select from the pop-up menu

Importing Data from an i.LINK-compatible Device to the HDD (Continued)

- Select “XP”, “SP”, “LP”, or “EP” from the “RECORDING MODE” option.

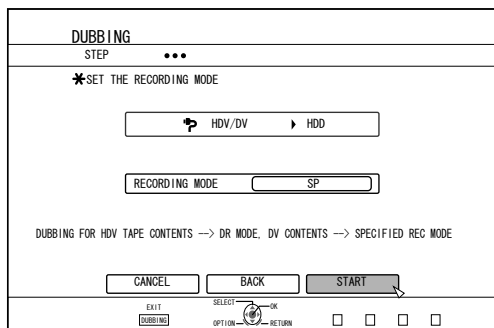

Memo:

- HDV contents will be imported in DR mode.
- For more details, refer to “Recording Modes” (page 28) .

4 Select “START”, and press the [OK] button

- Importing of the titles starts.
- After titles are successfully imported, a “DUBBING IS COMPLETED” message appears on the monitor.

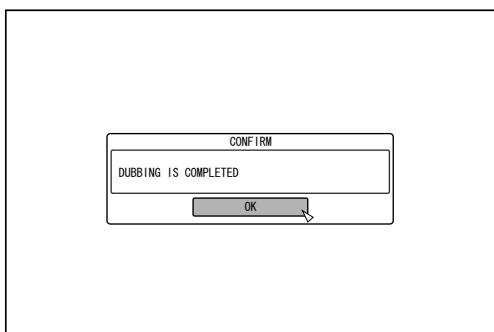

Imports data from current position

You can import videos from the current tape position till the end as follows.

1 Select “IMPORT FROM CURRENT POSITION”, and press the [OK] button

- A check mark is added to the “IMPORT FROM CURRENT POSITION” item.

2 Select “NEXT”, and press the [OK] button

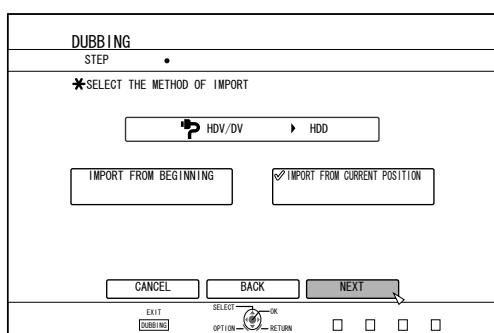

- A recording mode selection screen appears.

3 Select “RECORDING MODE” and press the [OK] button to display the pop-up menu

- Select “XP”, “SP”, “LP”, or “EP” from the “RECORDING MODE” option.

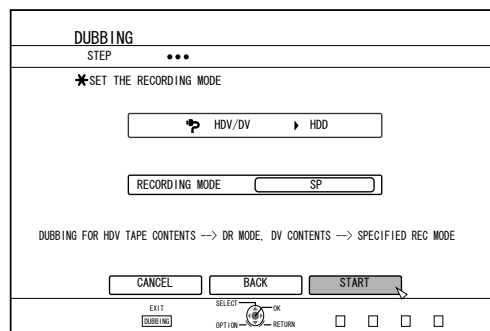

Memo:

- HDV contents will be imported in DR mode.

For more details, refer to “Recording Modes” (page 28) .

4 Select “START”, and press the [OK] button

- Importing of the titles starts.
- After titles are successfully imported, a “DUBBING IS COMPLETED” message appears on the monitor.

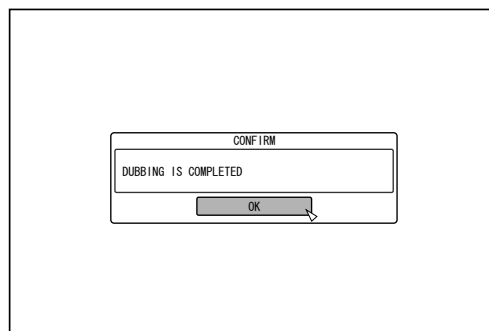

Cancel dubbing

■ To cancel importing before it starts

- Select “CANCEL” from the menu, and press the [OK] button to cancel importing of a title.
- Alternatively, you can press the [RETURN] button to cancel importing and return to the initial screen.

■ To cancel importing while it is in progress

- Press the [OPTION] button. Select “CANCEL” from the Cancel Importing menu, and press the [OK] button. Doing so imports data to the HDD up to the position where you have chosen to stop.

Dubbing a Title from the HDD to a BD/DVD

Titles stored in the internal HDD can be dubbed to a BD/DVD as follows.

Memo:

- Disc types that can be used for dubbing with this unit are: BD-RE, BD-R, DVD-RW, and DVD-R.

For more details, refer to “Discs that enable both dubbing and playback” (page 10).

- HD content for which the delete scene operation has been applied cannot be dubbed to BDMV. Perform seamless conversion before starting a dubbing operation.

For details, refer to “Mode conversion” (page 73).

Note:

- The following high bit-rate files may not meet the Blu-ray Disc standards when they are dubbed to a BD.
 - When a BDAV/BDMV disc is created (high-speed dubbing) by importing content captured in the JVC GY-HM700/100 SP mode.
 - When a BDAV disc is created (high-speed dubbing) by importing content captured in the JVC GZ-HD7/6 etc FHD mode.
 - When a BDAV/BDMV disc is created by importing content that is captured using another video camera at a peak bit-rate that exceeds 28.8 Mbps.
- If the Blu-ray Disc standards are not met, playback on another player may fail. To ensure that the standards are satisfied, perform high-speed dubbing after converting the recording mode, or perform dubbing by specifying a recording mode.

Dubbing from the HDD to a BD/DVD

■ Preparation

1 Set a BD or DVD on the disc tray

Memo:

- A message appears on the monitor in the following cases where a disc cannot be written to. Take the necessary actions according to the message.
 - When an incompatible disc type is set
 - When there is insufficient space on the set disc
 - When a finalized disc is set

2 Press the [DUBBING] button on the remote control unit

- The Dubbing menu screen appears.

3 On this screen, select “DISC↔VIDEO”

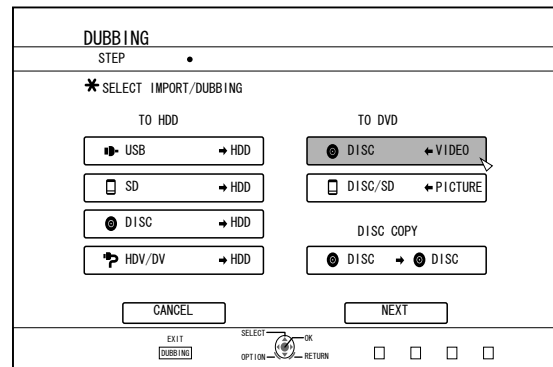

- A check mark is added to the “DISC↔VIDEO” item.

4 Select “NEXT”, and press the [OK] button

Memo:

- Dubbing can also be performed from the Playback Navigation screen.

- Select the titles to dub, and press the [OPTION] button
- Select “DUB”, and press the [OK] button
- Follow Steps 3 to 4 of “Preparation”

■ Dubbing titles

1 Select “RECORDING FORMAT”, and press the [OK] button

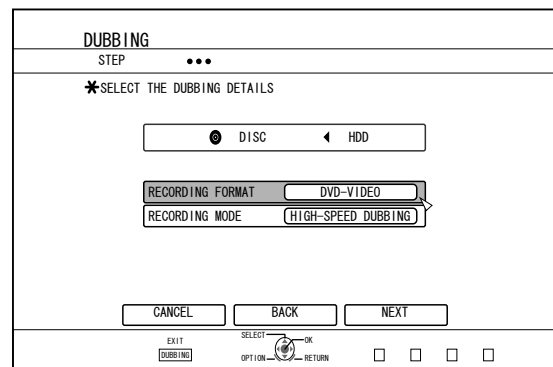

- Choose a format.

For more details, refer to “Format chart” (page 25).

2 Select “RECORDING MODE”, and press the [OK] button

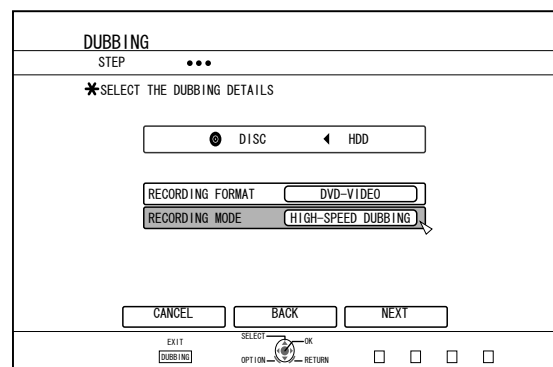

- Select “HIGH-SPEED DUBBING” or a recording mode of your preference.

Dubbing a Title from the HDD to a BD/DVD (Continued)

Memo:

- High-speed dubbing
Select this option if you want to significantly shorten the time required for dubbing. Make use of a disc that supports high-speed recording.
- AF/AN/AL/AE
Can be selected for BD-R and BD-RE. Dubbing is done with HD picture quality.
- XP/SP/LP/EP
Dubbing is done with SD picture quality.
- FR
An appropriate mode will be chosen automatically between XP to EP according to the remaining memory on the disc. For more details, refer to "Dubbing the video data from the HDD" (page 24) and "Recording Modes" (page 28).

3 Select "NEXT", and press the [OK] button

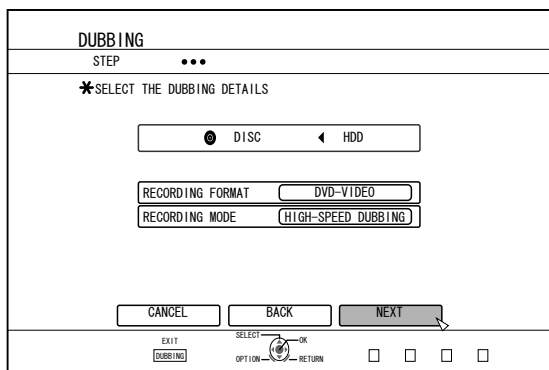

- A screen for creating a dubbing title list appears.

4 Create a dubbing title list

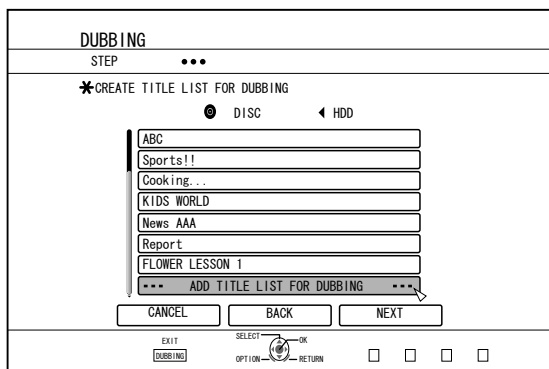

- Follow the steps below to create a dubbing title list.
 - ① Select "ADD TITLE LIST FOR DUBBING", and press the [OK] button
 - ② Select the titles to dub, and press the [OK] button

Memo:

- Press the [MARK] button. A check mark will appear beside the title.
All titles with a check mark can be added to the list at the same time.
- You can perform the following editing operations by selecting a title from the dubbing title list and pressing the [OK] button.
 - Delete the selected title from the list
 - Change the list arrangement
 - Change the name of the selected title
Select "RENAME TITLE", and press the [OK] button to change the title of the dubbing source. Dubbing of the new title is performed.

5 Select "NEXT", and press the [OK] button

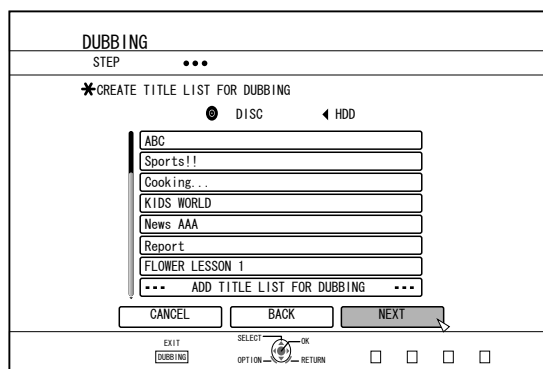

Note:

- "NEXT" cannot be selected for the following cases.
 - A title that cannot be dubbed has been selected
 - Disc memory is insufficient
 - A dubbing title list has not been created

Memo:

- Steps 6 and 7 are not applicable for "BD-VR" and "DVD-VR" disc formats. Go to step 8.

6 Select a background image for the disc menu

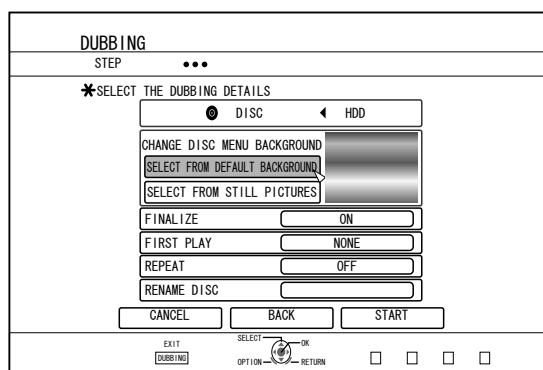

- Select a background image for the disc menu from "Background" or "Still Picture".
 - "SELECT FROM DEFAULT BACKGROUND"
A default background set is used for the disc menu.
 - "SELECT FROM STILL PICTURES"(only for SR-HD1500)
Use a still image on the HDD for the disc menu. The largest size allowed for a still image that is used as the background is 5120 x 3840.

Memo:

- The background image of the disc menu can be selected (only for DVD-Video and BD-MV).
- The following sizes are recommended for still images.
 - BD : 1920 x 1080
 - DVD : 720 x 480
- When a still image is used, the two vertical or horizontal edges are trimmed based on the side that is smaller than the aspect ratio of the video to be dubbed.

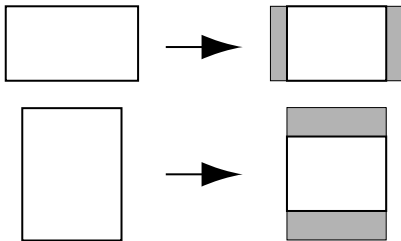

Example of Side-cut Still Image

7 Set the operations for finalize

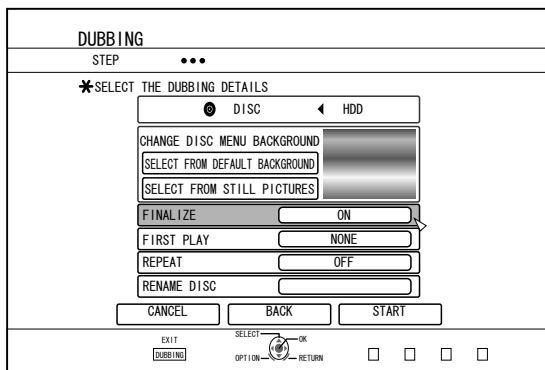

- Finalize will be performed after dubbing if "ON" has been set for "FINALIZE".
If a BD-MV disc is being dubbed, "OFF" cannot be set for "FINALIZE". And once the BD-MV disc is dubbed the disc cannot be rewritten.
- If a DVD-Video or BD-MV disc is being dubbed, the settings for "FIRST PLAY", "REPEAT" and "RENAME DISC" can be changed.

① **Select "FIRST PLAY", and select either "NONE", "TOP MENU" or "TITLE 1"**

- "NONE"

A finalized disc will not be automatically played back when it is inserted into another device.

- "TOP MENU"

The disc menu will be displayed automatically when a finalized disc is inserted into another device.

- "TITLE 1"

The first title on a finalized disc will be played back automatically when it is inserted into another device.

Memo:

- "NONE" cannot be selected for "FIRST PLAY" for BD-MV.

② **Select "REPEAT", and choose either "OFF" or "ON"**

- "OFF"

The disc will stop and the menu will be displayed after all the titles are played back.

- "ON"

Repeat playback from the first title will start automatically after all the titles are played back.

③ **Select "RENAME DISC", and press the [OK] button**

- Change the disc name when finalizing is performed.

8 Select "START", and press the [OK] button

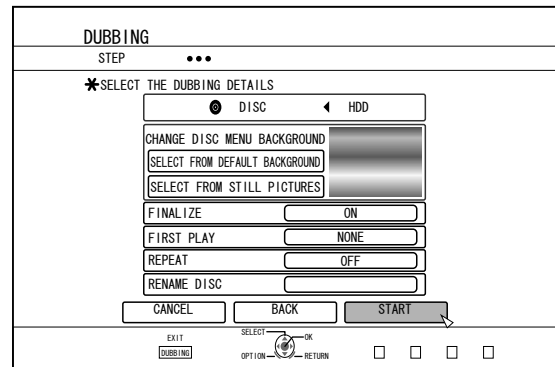

- Dubbing starts. A progress bar is displayed during the dubbing process.
- After dubbing is complete, a "DUBBING IS COMPLETED" message appears on the monitor.

Memo:

- Choose "BACK" from the menu and press the [OK] button to return to the previous screen.

■ Cancel dubbing

To cancel dubbing before it starts

- Select "CANCEL" from the menu, and press the [OK] button to cancel dubbing.
- Alternatively, you can press the [RETURN] button to cancel dubbing and return to the initial screen.

To discontinue dubbing while it is in progress

- Press the [OPTION] button. Select "CANCEL" from the Cancel Dubbing menu, and press the [OK] button.

Memo:

- When dubbing to a BD-R or DVD-R, the disc memory will be reduced as data will still be written onto the disc up to the point where dubbing is discontinued.

Dubbing Still Images from the HDD

Still images stored in the internal HDD can be dubbed to a BD-RE or an SD card as follows.

Memo:

- Only “JPEG” still image format is supported.

For more details, refer to “Dubbing the picture data from the HDD” (☞ page 24) .

■ Before dubbing

- Dubbing to a disc
Set the BD-RE for dubbing on the disc tray
- Dubbing to an SD card
Insert the SD card to be dubbed into the [SD SLOT]

■ Dubbing still images

1 Press the [DUBBING] button on the remote control unit

- The Dubbing menu screen appears.

2 On this screen, select “DISC/SD⇄PICTURE”

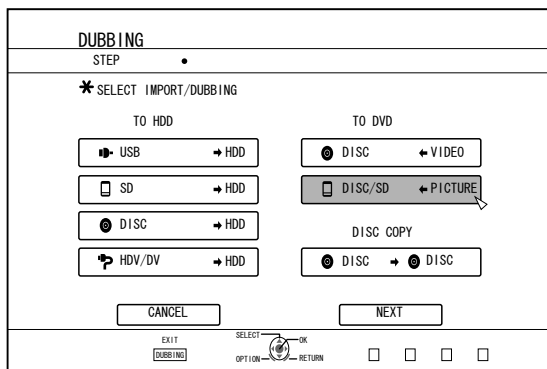

3 Select the media to dub to from the media selection screen

- A checkmark will be added to the selected media.

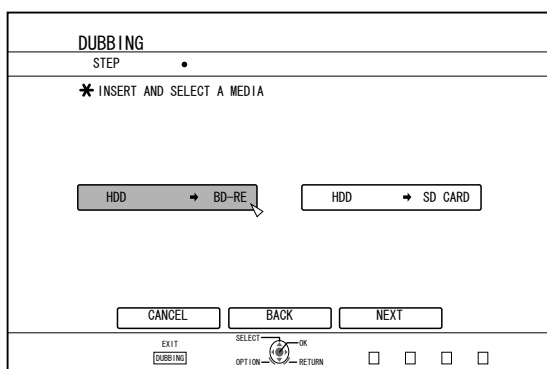

4 Select “NEXT”, and press the [OK] button

Memo:

- A message appears on the monitor when dubbing cannot be performed in the following cases. When this occurs, replace the disc or SD card with one that is usable.

- When an incompatible disc or SD card is set
- When there is insufficient space on the set disc or SD card
- When an unformatted disc or SD card is set

For details, refer to “Formatting a disc” (☞ page 25) or “Formatting an SD Card” (☞ page 27) .

5 Select the still images to dub, and press the [MARK] button

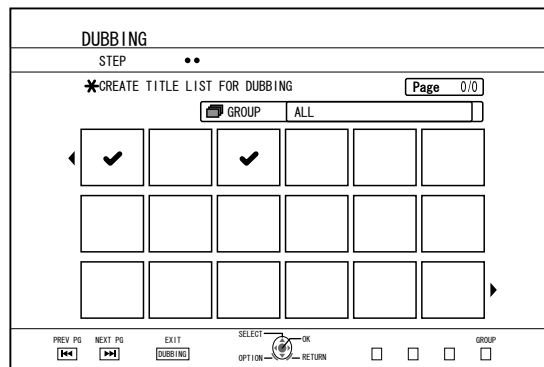

- Pressing the [MARK] button adds a check mark to the selected image.
All still images with a check mark are dubbed.

Memo:

- To clear the check mark, select the corresponding still image, and press the [MARK] button.
- Pressing the [OPTION] button displays a pop-up menu. The pop-up menu enables you to perform the following operations.

- BACK : Exits the pop-menu and returns to the initial screen.
- SELECT ALL : Selects all still images within the same group.
- DESELECT ALL : Clears the selection of all still images within the same group.

Note:

- A message appears if the selected still images do not fit into the disc. Check mark cannot be added to a still image if there is insufficient space on the disc.

6 Select "START", and press the [OK] button

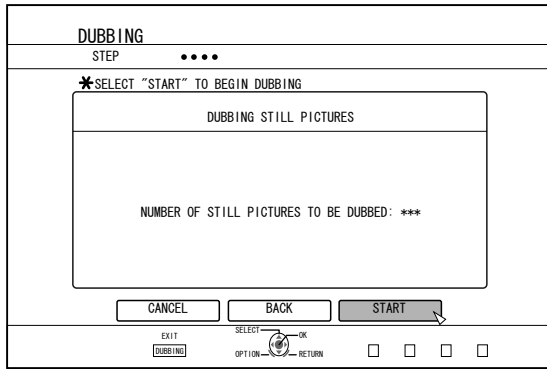

- Dubbing starts. A progress bar is displayed during the dubbing process.
- After dubbing is complete, a "DUBBING IS COMPLETED" message appears on the monitor.

Memo:

- A directory of the following configuration is created in the media, and still images are written with file names ranging from "PIC_0001.jpg" to "PIC_9999.jpg".

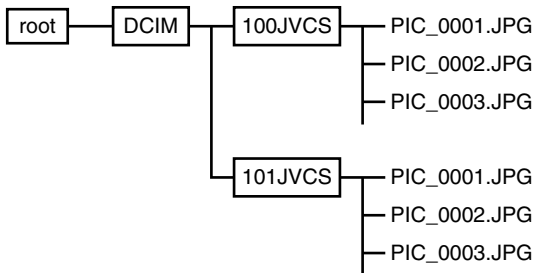

■ Dubbing from the Playback Navigation screen

Dubbing can also be performed from the Playback Navigation screen.

1 Select the still images to dub, and press the [OPTION] button

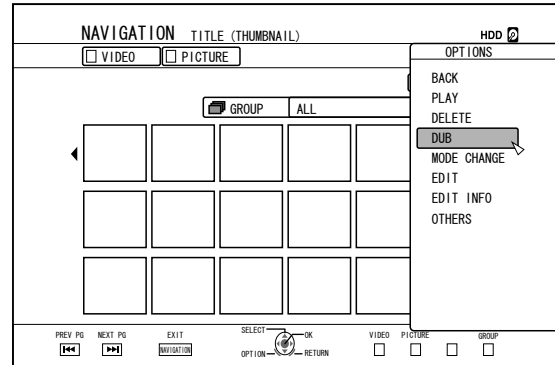

2 Select "DUB", and press the [OK] button

3 Follow steps 3 to 5 of "Dubbing still images"

Memo:

- Check marks of still images that appear on the Playback navigation screen will remain added to the image on the still image selection screen.

■ Cancel dubbing

To cancel dubbing before it starts

- Select "CANCEL" from the menu, and press the [OK] button to cancel dubbing.
- Alternatively, you can press the [RETURN] button to cancel dubbing and return to the initial screen.

To discontinue dubbing while it is in progress

- Press the [OPTION] button. Select "CANCEL" from the Cancel Dubbing menu, and press the [OK] button.

Enabling Playback on Other Devices (Finalizing)

DVD-R and DVD-RW discs may need to be finalized before they can be played on other DVD players.

Memo:

- Discs in the Video mode becomes a DVD-Video format with a title menu after finalizing.
- Discs containing DVD-Video data can be finalized by setting the disc operation settings according when the disc is inserted into this unit.
- Recording or editing of the disc will not be possible after it is finalized.
- If a DVD that was recorded using VR mode has been finalized, the disc can only be played back on VR mode compatible devices.

Finalizing

1 Set the BD or DVD to be finalized on the disc tray

2 Press the [MEDIA MANAGE] button on the remote control unit

- The Media Management menu screen appears.

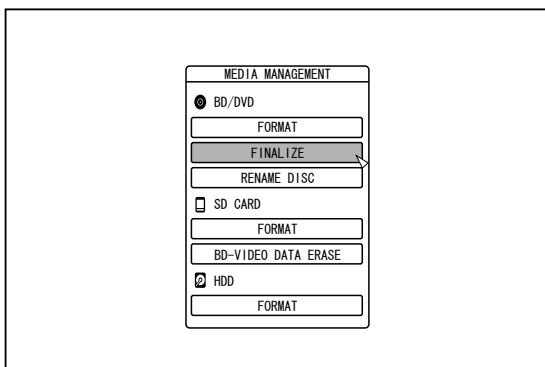

3 Select "FINALIZE" from "BD/DVD"

4 Select "YES" and press the [OK] button

- The top menu setting screen appears.

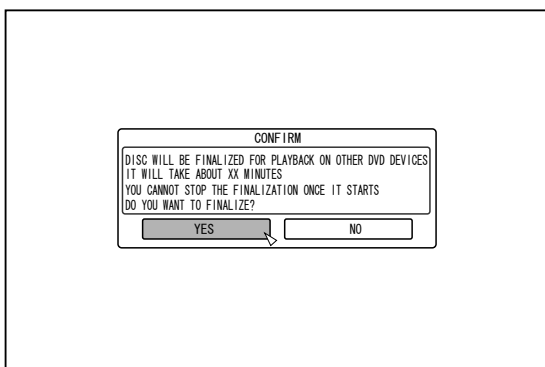

Memo:

- To cancel the finalizing operation, select "NO" and press the [OK] button.

5 Setting the top menu items

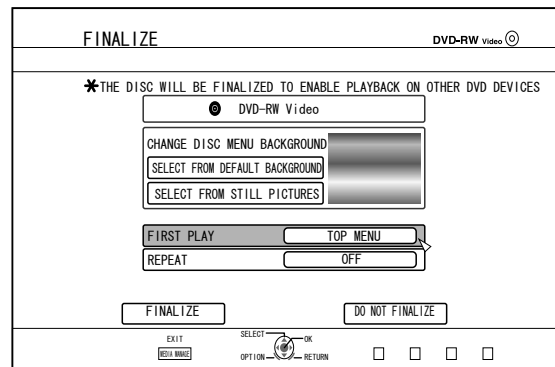

- Before finalizing, set "FIRST PLAY", "REPEAT", and "CHANGE DISC MENU BACKGROUND" accordingly. Set according to the steps below.

① Select "FIRST PLAY", and select an appropriate first play setting item

- This item is used for setting the disc operation when a finalized disc is inserted into another device.

NONE : A finalized disc will not be automatically played back when it is inserted into another device.

TOP MENU : The disc menu will be displayed automatically when a finalized disc is inserted into another device.

TITLE 1 : The first title on a finalized disc will be played back automatically when it is inserted into another device.

② Select "REPEAT", and select an appropriate repeat setting item

- Set the disc action to be taken after all titles have been played back.

OFF : The disc will stop and the menu will be displayed after all the titles are played back.

ON : Repeat playback from the first title will start automatically after all the titles are played back.

- ③ Select “CHANGE DISC MENU BACKGROUND” to select a background image for the top menu
- You can register and use a background image of your preference.

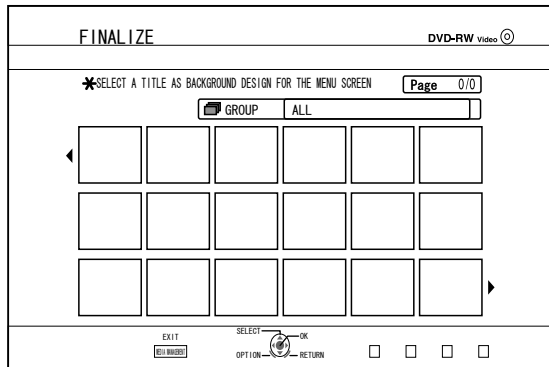

Memo:

- The items in “FIRST PLAY”, “REPEAT” and “CHANGE DISC MENU BACKGROUND” can also be set in “Dubbing a Title from the HDD to a BD/DVD” (page 39).

6 Select “FINALIZE”, and press the [OK] button

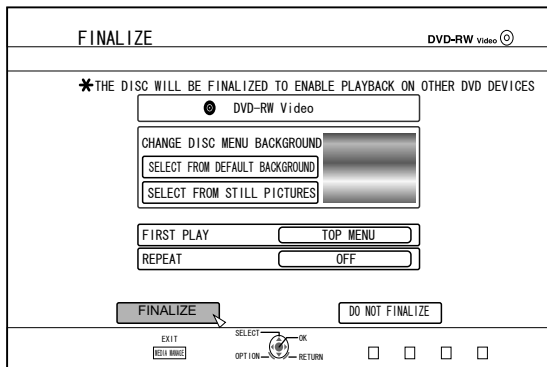

- Finalizing starts.
- After finalization is complete, a “THE DISC HAS BEEN FINALIZED” message appears on the monitor.

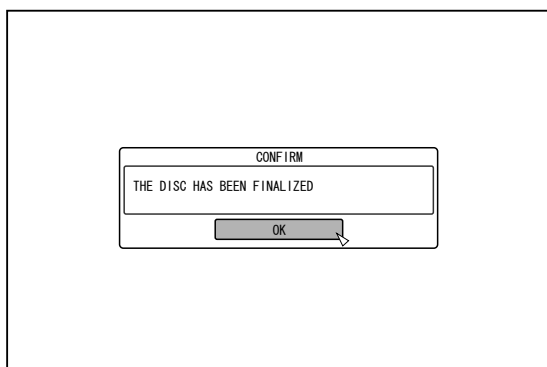

Unfinalizing a disc

Only DVD-RW discs that are finalized on this unit can be unfinalized. After a disc is unfinalized, addition of new titles and editing are possible.

Note:

- All discs except DVD-RW (VR mode) cannot be unfinalized.

To unfinalize a disc

- Set a DVD-RW disc that is finalized by this unit on the disc tray
 - Press the [MEDIA MANAGE] button on the remote control unit
- The media management menu screen appears.

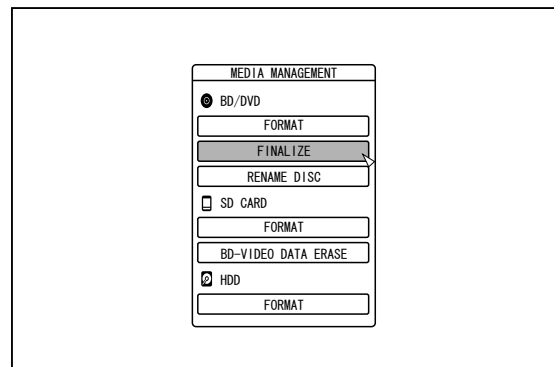

3 Select “FINALIZE” from “BD/DVD”

4 Select “YES” and press the [OK] button

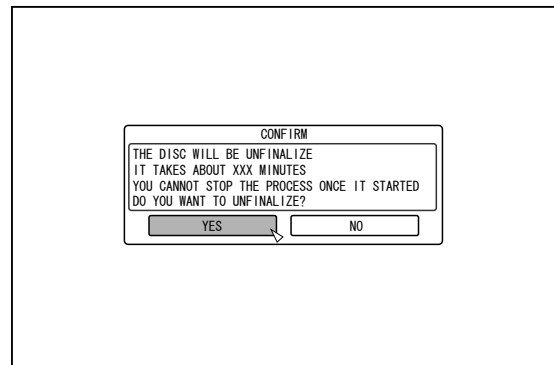

- Unfinalizing starts.
- After unfinalizing is complete, a “THE DISC HAS BEEN UNFINALIZED” message appears on the monitor.

Copying the Entire Disc

Copying the entire disc allows all content on a BD (BDMV) or DVD (AVCHD, DVD-Video) to be copied onto another disc.

Note:

- Content cannot be copied to a formatted BD-R or DVD-R disc. Make use of an unformatted disc.
- Use a DVD-R/-RW instead of a BD-R/-RE or DVD when the source disc is a BD disc.
- The disc to be copied onto will be formatted when copy is performed. Check that the disc has not been used before or if it is ok to delete data on the disc when using a BD-RE or a DVD-RW.
- In the case of BD, volume labels are not copied.
- If an unsupported disc is set, "UNABLE TO IMPORT FROM DISC" or "UNABLE TO DUB ONTO DISC INSERT ANOTHER DISC" will be displayed on the monitor. Use a disc that is supported by this unit.

For details on discs that are supported by this unit, refer to "Discs that enable both dubbing and playback" (page 10) and "Discs that enable playback only" (page 10).

1 Press the [DUBBING] button on the remote control unit

- The Dubbing screen appears.

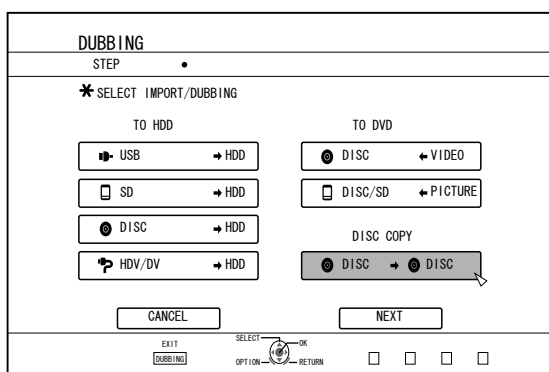

2 Select "DISC→DISC", and press the [OK] button

- A menu screen for copying the entire disc appears.

Memo:

- During copy of the entire disc, data is temporarily copied to the internal HDD.
- Only discs that are not copyright-protected can be copied.

3 Set the number of discs to copy using the [▲/▼] buttons

- You can specify up to a maximum of 10 discs.

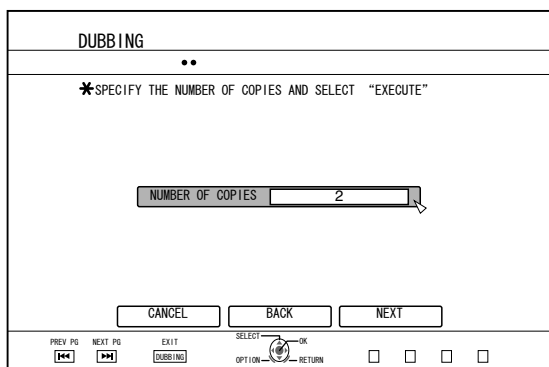

4 Select "NEXT", and press the [OK] button

- The disc tray will open automatically.

5 Set the source BD or DVD on the disc tray

6 Select "START", and press the [OK] button

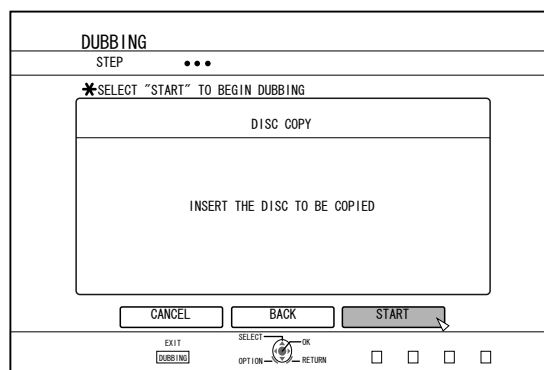

- The disc tray will close automatically. The source BD or DVD will be recognized, and copying to the internal HDD will proceed.

- The disc tray will open automatically after copying has finished and "READY TO COPY NOW. INSERT THE DISC FOR COPYING" will be displayed on the monitor.

Memo:

- Confirm the insufficient space on the internal HDD when the copy interrupts.

7 Set a BD or DVD to copy on the disc tray

8 Select "START", and press the [OK] button

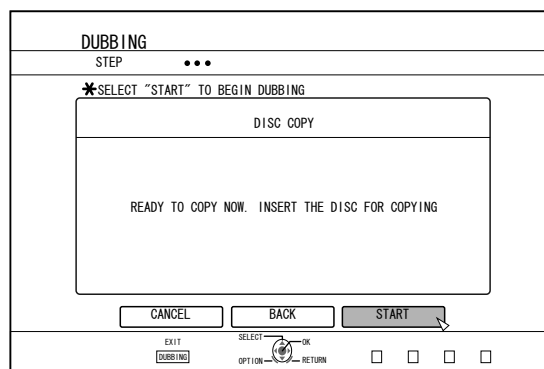

- The disc tray will close automatically. BD or DVD will be recognized, and the contents that were copied to the HDD will be copied to the disc.

Memo:

- The copy operation will not be performed when the remaining disc memory is not sufficient.

9 Complete the entire disc copying

- After copy is complete the tray will open automatically, and copy of the entire disc ends.

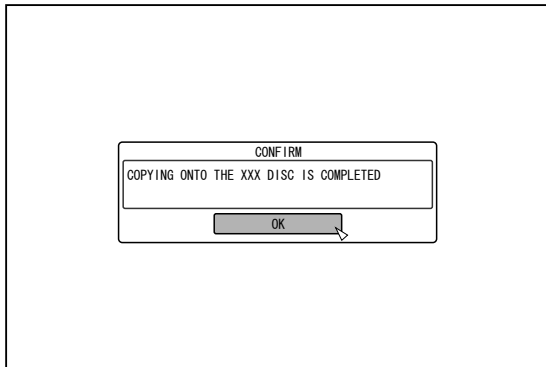

Memo:

- The screen prompting you to insert a new disc appears repeatedly until this unit has finished copying the number of discs specified in Step 3. When the message appears, set a new BD or DVD on the disc tray, select "START", and press the [OK] button.

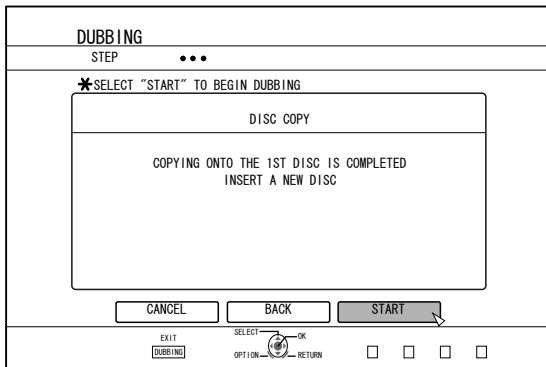

- After copy is complete, the data copied onto the HDD will be deleted.
- Select "CANCEL" from the menu, and press the [OK] button to cancel disc copying.

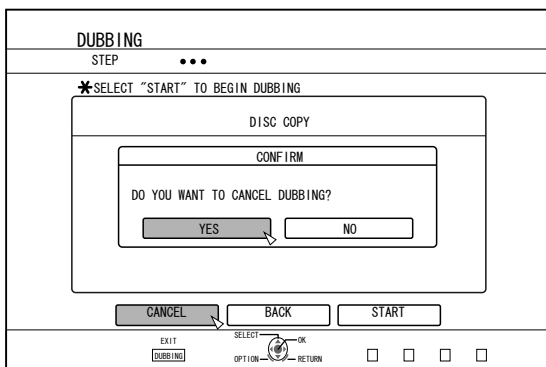

Recording Using External Inputs

Videos on an external device that is connected to i.LINK (HDV/DV) or video / S-video input can be recorded to the HDD. BD, DVD can be recorded from the [VIDEO]/[S-VIDEO] input.

Memo:

- Only titles that are not copyright-protected can be imported.

- 1 Press the [HDD] or [BD/SD] button to select the location to record the file
- 2 Press the [INPUT SELECT] button on the remote control, and choose external input (HDV/DV or L-1)
- 3 Press the [REC MODE] button and select a recording mode
- 4 Press the [●] and [▶] remote control buttons together to start the recording process
- 5 Operate the external device using i.LINK(HDV/DV) or the video/S-video input to output the videos to be recorded
- 6 Press the [■] button on either this unit or the remote control to display the pop-up screen, choose "STOP" and press the [OK] button

- Recording can also be start by pressing the [●] button on this unit.

- End the recording.

Memo:

- When recording images via a video camera using i.LINK connection, recording may stopped if the video camera is loaded with a DV tape while in the shooting mode. In this case, remove the DV tape before recording.
- Recording will be stopped if the maximum recording time has been reached, or if there is insufficient memory in the media.
- For HDV contents, "DR" will be used to record instead of the selected recording mode.
- RECORDABLE MEDIA

RECORDING MODE	RECORDABLE MEDIA		
	HDD	DVD-RW (VR format)	BD-RE (BD-AV format)
DR	HDV	-	-
AF (HD)	-	-	-
AN (HD)	-	-	-
AL (HD)	-	-	-
AE (HD)	-	-	-
XP (SD)	DV/L1	L1	L1
SP (SD)	DV/L1	L1	L1
LP (SD)	DV/L1	L1	L1
EP (SD)	DV/L1	L1	L1

- MAXIMUM CONTINUOUS RECORDING TIME
 HDD : 24 hours (*1)
 DVD-RW : 8 hours
 BD-RE : 8 hours
 *1: Title will automatically be split into time separated by 8 hours. The dividing point will not be recorded.

For the recording modes and maximum recording time for each disc, refer to "Recording Modes" (page 28) .

About Playing Back

Videos or edited videos stored on the internal HDD, as well as videos stored on a disc or SD card can be played back on this unit. The types of media that are playable on this unit are as follows.

- Videos and still images stored on the internal HDD
- Videos stored on different disc types
- Videos and still images stored on backup discs created using the “Everio Writer”
- Videos and still images stored on SD cards

These videos can be easily played back for viewing using the “Playback Navigation” software that comes with this unit. For details on the “Playback Navigation” software, refer to “Using Playback Navigation” (☞ page 48) .

Memo:

- This unit does not support DivX videos.
- If AVCHD files are displayed in thumbnails, black bars may appear on the left and right borders depending on the video resolution.
- To display MOV* files stored on an SD card using Playback Navigation, make use of list display. Thumbnail display is not supported. Files on the SD card cannot be played back directly. To do so, import them into a HDD.
- For details on importing MOV* files from an SD card, refer to “Importing Data from an SD Card to the HDD” (☞ page 35) .

MOV* : MOV files that are taken in SP mode using the JVC ProHD Camcorder GY-HM700/100

Display Marks on the Playback Navigation Screen

Icon	Mark name	Explanation
	Protect Mark	Indicates protected titles.
	Mode Conversion Preset Mark	Indicates titles for which mode conversion has been preset.
	Not Viewed Mark	Indicates titles that have not been viewed or groups containing titles that have not been viewed.
	Scene Delete Mark	Indicates titles for which scene delete or chapter delete has been applied.
	Group Mark	Indicates a group.
	Playlist Mark	Indicates a playlist.
	Not Playable Mark	Indicates titles that cannot be played.
	Question Mark	Indicates titles of which the thumbnails cannot be displayed. Playback may not be possible.

Using Playback Navigation

Videos can be easily played back for viewing using the “Playback Navigation” function available on this unit.

Displaying the Playback Navigation screen

1 Select the location of the playback file

- Press the [HDD] button on the remote control unit
Play back videos or still images stored on the HDD.
- Press the [BD/SD] button on the remote control unit.
Play back videos or still images stored on a BD/DVD or a SD.

2 Press the [NAVIGATION] button on the remote control unit

- The Playback Navigation screen appears.

Memo:

- Pressing the [BD/SD] button each time switches the media to play back between BD/DVD and SD.
- You can also switch the media to play back by pressing the [HDD] or [BD/SD] button when the Playback Navigation screen is displayed.

Operating Playback Navigation

■ **Playing a video/still image**

Plays the selected video/still image.

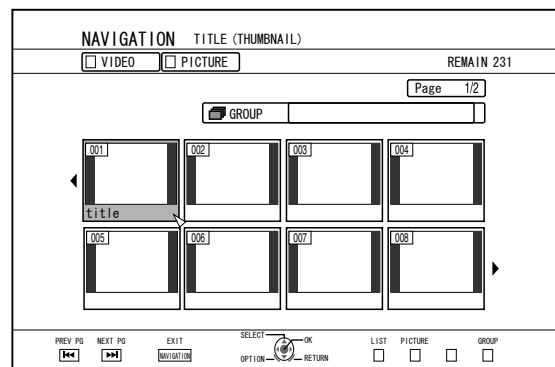

- Select a title to play back, followed by pressing the [OK] or [▶] button to play the selected video/still image.

Memo:

- Select a group and press the [OK] button to display all titles in the group.

Switching between thumbnail and list displays

You can switch between the thumbnail display and list display of a video.

- When the video thumbnail list screen is displayed

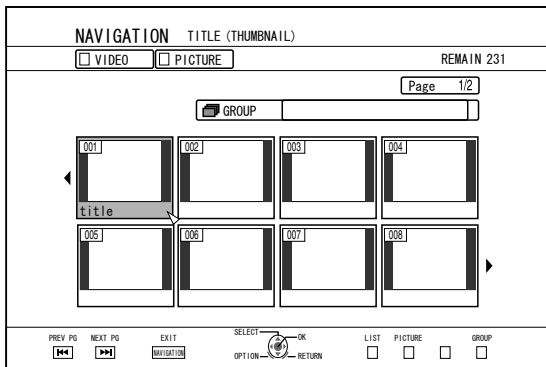

Press the [RED] button to display the title list screen.

- When the title list screen is displayed

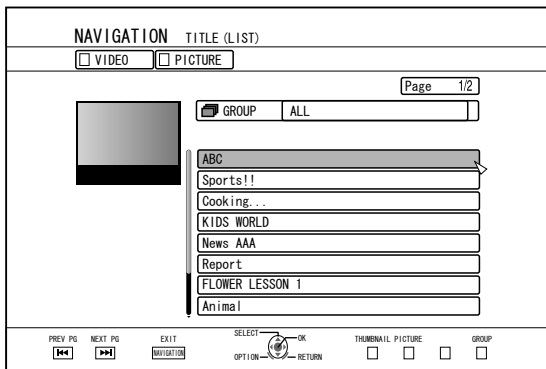

Press the [RED] button to display the video thumbnail list screen.

Displaying a group/folder

A group/folder screen can be displayed.

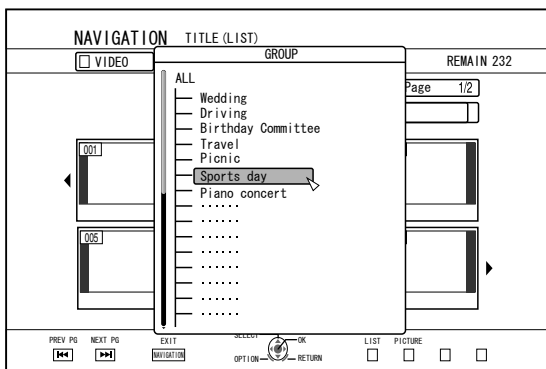

Press the [YELLOW] button to display the group/folder screen.

Switching between video and still image displays

You can switch the display between the video thumbnail screen and still image thumbnail screen.

- When the video thumbnail list screen is displayed

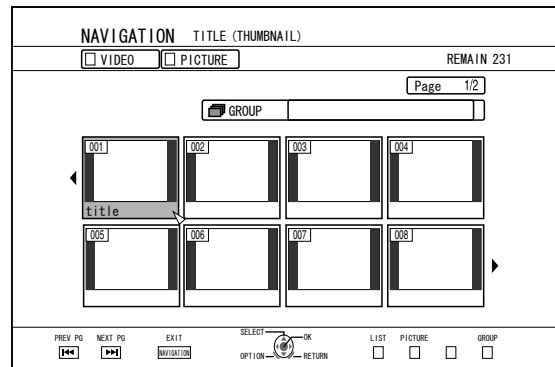

Press the [GREEN] button to display the still image thumbnail list screen.

- When the still image thumbnail list screen is displayed

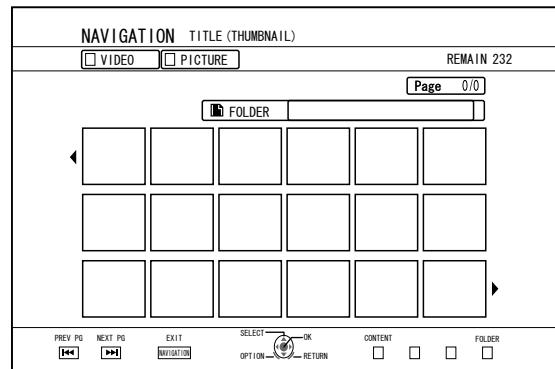

Press the [RED] button to display the video thumbnail list screen.

Displaying the Option menu

Displaying the Option menu enables you to perform different operations on a selected title/group, including "BACK", "PLAY", "DELETE", "DUB", "GROUP", "UNGROUP", "DO NOT GROUP", "MODE CHANGE", "EDIT", "EDIT INFO" and "OTHERS".

1 Select a title/group, and press the [OPTION] button

- An Option menu appears.

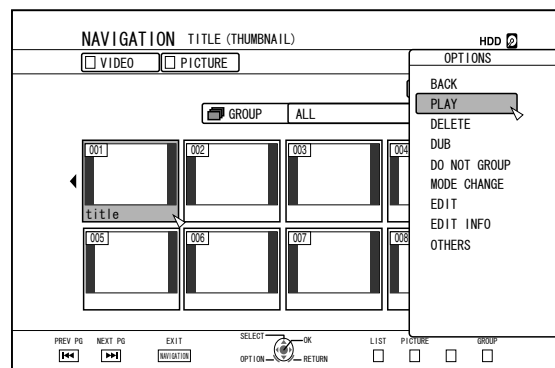

Using Playback Navigation (Continued)

2 Select an operation option, and press the [OK] button

- Options that cannot be operated are displayed in gray and cannot be selected.

For details on the Option menu items, refer to "Option menu list" (☞ page 50) .

Option menu list

- BACK**
Returns to the previous screen.
- PLAY**
Plays back the selected title/group.
For details on the button operations during playback, refer to "Video Playback Operation" (☞ page 51) .
- DELETE**
Deletes a selected title/group.
For details, refer to "Deleting a Title/Group" (☞ page 62) .
- DUB**
Performs dubbing of a selected title/group.
For details, refer to "Dubbing/Importing" (☞ page 23) .
- GROUP**
Groups the selected titles/groups.
For details, refer to "Grouping" (☞ page 60) .
- UNGROUP**
Ungroups a selected group.
For details, refer to "Ungrouping" (☞ page 60) .
- DO NOT GROUP**
Removes the selected titles from a group.
For details, refer to "Excluding from a group" (☞ page 61) .
- MODE CHANGE**
Changes the mode of the selected title/group.
For details, refer to "Mode conversion" (☞ page 73) .
- CHAPTER LIST**
Displays the chapters of a selected title.
- EDIT**
Switches to the menu screen of the sub-items.
 - CHAPTER EDIT**
Switches to the chapter edit screen of the selected title.
For details, refer to "Editing a Chapter" (☞ page 67) .
 - PLAYLIST EDIT**
Switches to the playlist edit screen of the selected title.
For details, refer to "Creating a Playlist" (☞ page 65) .
 - DELETE SCENE**
Switches to the delete scene screen of the selected title.
For details, refer to "Delete Scenes" (☞ page 70) .
 - DIVIDE**
Switches to the dividing screen of the selected title.
For details, refer to "Dividing" (☞ page 69) .
- EDIT INFO**
Switches to the menu screen of the sub-items.
 - MODIFY TITLE NAME/MODIFY GROUP NAME**
Switches to the rename screen for the selected title/group name.
For details, refer to "Changing the Title/Group Name" (☞ page 62) .
 - MODIFY THUMBNAIL**
Switches to the thumbnail modification screen of the selected title.
For details, refer to "Editing a Thumbnail" (☞ page 66) .
 - MODIFY DATE**
Switches to the recording date modification screen of the selected title.
For details, refer to "Changing the Shooting Date/Time" (☞ page 72) .
 - PROTECT**
Switches to the protection screen of the selected title/group.
For details, refer to "Turning On Title/Group Protection" (☞ page 63) .
 - UNPROTECT**
Switches to the screen for turning off protection of the selected title/group.
For details, refer to "Turning Off Title/Group Protection" (☞ page 64) .
- OTHERS**
Switches to the menu screen of the other-items.
 - CHAPTER LIST**
 - DETAILS**
 - THUMBNAIL**
 - LIST**
 - VIDEO**
 - PICTURE**
 - GROUP**
 - FOLDER SELECT**
 - CONTENT**

Video Playback Operation

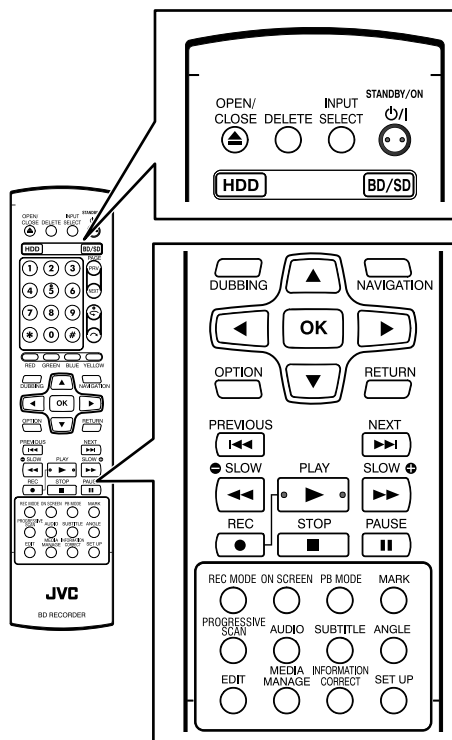

Frequently used button operations

■ [▶] button

- If the stop position (resume point) is memorized in the selected video, pressing the button plays back the video from this position.
The video may not resume playback depending on the media and settings used. Refer to "RESUME" (page 77).
- If playback is paused (Still mode), pressing the button resumes playback.

■ [■] button

- Pressing the button stops playback after memorizing the stop position (resume point).
- Pressing the button again after playback stops clears the memory of the stop position (resume point).

■ [||] button

- Pressing the button stops playback temporarily.

■ [▶▶] button

- Pressing the button once during playback switches to a playback speed of 1.3 times (with audio sound).
- Pressing the button in the 1.3x playback or fast forward mode fast forwards the video.
Pressing the button each time switches the search speed. (5x⇒10x⇒30x⇒60x)

Memo:

- The listed speed for searching and slow motion is an approximate amount.
- Pressing the button in the Still mode forwards the video frame by frame.
- Pressing and holding down the button in the Still mode starts playback in slow motion.
Pressing the button during playback in slow motion switches the playback speed. The speed changes each time the button is pressed. (1/24x⇒1/16x⇒1/8x⇒1/2x)

■ [◀◀] button

- During normal playback, 1.3x playback, fast forward, or fast reverse, pressing the button fast reverses playback.
Pressing the button each time switches the search speed. (1x⇒5x⇒10x⇒30x)
- Pressing the button in the Still mode reverses the video frame by frame.
- Pressing and holding down the button in the Still mode starts reverse playback of the video in slow motion.
Pressing the button during playback in slow motion switches the playback speed. The speed changes each time the button is pressed. (1/24x⇒1/16x⇒1/8x⇒1/2x)

Memo:

- The listed speed for searching and slow motion is an approximate amount.

■ [▶▶] / [◀◀] button

- Pressing any of the buttons moves the chapter position.

■ [MARK] button

- Pressing the button enables you to add a chapter mark to a title.

Video Playback Operation (Continued)

■ [] button

- During normal playback, 1.3x playback, slow motion playback, fast forward, or fast reverse, pressing the button moves the playback position forward by about 30 seconds. Pressing the button multiple times moves playback to the position equivalent to the number of times pressed multiplied by 30 seconds.
- Normal playback will resume after the position has been moved. If pressed during 1.3x playback, 1.3x playback will continue after the position has been moved. Contents may be played back in the normal mode depending on the type of disc or content.
- Pressing the button in the Still mode moves the current paused position forward by about 30 seconds while maintaining the Still mode.

■ [] button

- During normal playback, 1.3x playback, slow motion playback, fast forward, or fast reverse, pressing the button moves the playback position back by about seven seconds. Pressing the button multiple times moves playback to the position equivalent to the number of times pressed multiplied by seven seconds.
- Normal playback will resume after the position has been moved. If pressed during 1.3x playback, 1.3x playback will continue after the position has been moved. Contents may be played back in the normal mode depending on the type of disc or content.
- Pressing the button in the Still mode moves the current paused position back by about seven seconds while maintaining the Still mode.

■ [HDD] button

- During playback of videos on a “BD/DVD” or “SD”, pressing the button stops the current playback and switches to the “HDD” mode.
Pressing the button during display of the Playback Navigation screen switches to the Playback Navigation screen for the “HDD” mode.

■ [BD/SD] button

- During playback of videos on a “BD/DVD” or “SD”, pressing the button stops the current playback and switches from “BD/DVD” to “SD” or vice versa.
Pressing the button during display of the Playback Navigation screen switches to the Playback Navigation screen for the other media. During playback of videos on the “HDD”, pressing the button stops the current playback and switches to “BD/DVD” mode.

Memo:

- The display switches automatically to the SD mode only if the inserted SD card contains playable videos or still images.
-

Useful button operations

■ [PB MODE] button

- Displays the Playback Settings screen, which enables you to modify the settings.
For details, refer to “Changing Playback Settings”.

■ [AUDIO] button

- Switches the audio channel.

■ [SUB TITLE] button

- Switches the subtitle display.

■ [ANGLE] button

- Switches the angle.

Memo:

- Pressing the [AUDIO], [SUB TITLE], or [ANGLE] button has no effect if their selection is not available in the playback video.
-

Playing Videos on a BD/DVD

Playback starts automatically after a BD/DVD is set. If the Auto Play feature is disabled, play the title using Playback Navigation.

Memo:

- For details on the button operations during playback, refer to “Video Playback Operation” (page 51).

Playing a disc when Auto Play is enabled

1 Set a BD or DVD on the disc tray

- Auto Play starts.

Playing a disc when Auto Play is disabled

1 Set a BD or DVD on the disc tray

2 Press the [NAVIGATION] button

- The Playback Navigation screen appears.

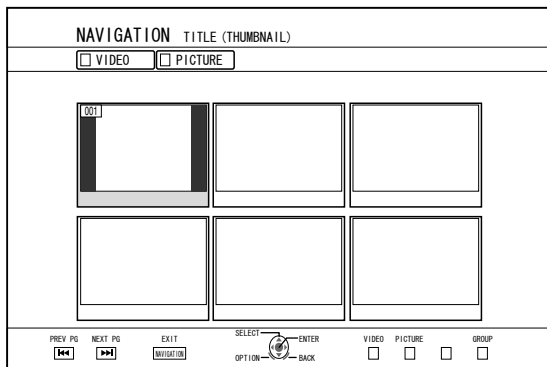

3 Select a title, and press the [OK] button

- Playback of the selected title starts.

Memo:

- If the current playback location is HDD or SD, press the [BD/SD] button on the remote control unit to switch it to BD/DVD.
- Videos can also be played back without starting up Playback Navigation. Pressing the [▶] button starts playback from the stop position (resume point) of the disc. If the stop position (resume point) is not memorized or if the setting for resume has been set to “OFF”, playback starts from the beginning of the disc.

Playing an EverioBackup Disc*

EverioBackup* : Data disc containing high-definition videos that are recorded in the MPEG2 format using a DVD writer for Everio.

1 Set the disc on the disc tray

2 Press the [NAVIGATION] button

- The Playback Navigation screen appears.

3 Select a title, and press the [OK] button

- Playback of the selected title starts.

Memo:

- If the current playback location is HDD or SD, press the [BD/SD] button on the remote control unit to switch it to BD/DVD.
- Videos can also be played back without starting up Playback Navigation. Pressing the [▶] button plays back titles starting from that with the oldest recording date.

Playing Video Discs Created Using a PC

Videos that are created using a PC can be played back using Playback Navigation.

1 Set the disc on the disc tray

2 Press the [NAVIGATION] button

- The Playback Navigation screen appears.

3 Select a title, and press the [OK] button

- Playback of the selected title starts.

Memo:

- The formats that can be played back are BDAV, BDMV, DVD-Video and DVD-VR (CPRM-compatible).
- If the current playback location is HDD or SD CARD, press the [BD/SD] button on the remote control unit to switch it to BD/DVD.
- Videos can also be played back without starting up Playback Navigation. Pressing the [▶] button starts playback from the stop position (resume point) of the disc. If the stop position (resume point) is not memorized or if the setting for resume has been set to “OFF”, playback starts from the beginning of the disc.
- Playback may not be possible due to compatibility problems.

Playing Videos on the HDD

Titles stored on the HDD can be played back using Playback Navigation.

You can select a video to play from "Title", "Group", or "Playlist".

Memo:

- For details on the button operations during playback, refer to "Video Playback Operation" (page 51).

Playing titles stored on the HDD

1 Press the [NAVIGATION] button

- The Playback Navigation screen appears.

2 Select the titles to playback, and press the [▶] button

- Playback of the selected title starts.

Memo:

- If the current playback location is "BD/DVD" or "SD CARD", press the [HDD] button on the remote control unit to switch it to "HDD".
- To play back specific titles within a group, select the group, press the [OK] button, and select the titles accordingly.
- Videos can also be played back without starting up Playback Navigation.
Pressing the [▶] button starts playback of the most recently played title.
If there are no recently played titles, playback starts from the title with the most recent recording date.

Playing Videos on a SD Card

Titles stored on an SD card can be played back using Playback Navigation.

You can select a video to play from "Title".

1 Insert the SD card into the [SD SLOT]

- Switch the playback location to "SD CARD" after the SD card is detected by the unit.

2 Press the [NAVIGATION] button

- The Playback Navigation screen appears.

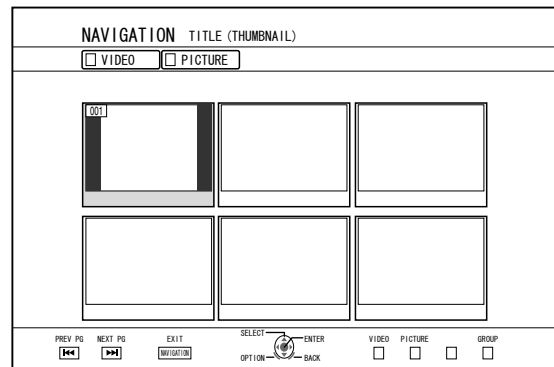

3 Select a title, and press the [OK] button

- Playback of the selected title starts.

Memo:

- Playback navigation displays AVCHD files stored on the SD card in titles, not in scenes (chapters). Titles are grouped such as according to the date, recording mode, or number of scenes. Make use of thumbnail display to display titles. List display is not supported.
- The formats that can be played back are AVCHD and SD-VIDEO. If AVCHD files are displayed in thumbnails, black bars may appear on the left and right borders depending on the video resolution.
- When there are files of different formats (AVCHD, SD-VIDEO, MOV*) in the SD card, press the [RED] button to select the format you want to display.
MOV*: MOV files that are taken in SP mode using the JVC ProHD Camcorder GY-HM700/100
- Videos can also be played back without starting up Playback Navigation.
Pressing the [▶] button starts playback from the stop position (resume point).
If the stop position (resume point) is not memorized, playback starts from the beginning of the playable content.
If the setting for "QUICK STARTUP" is set to "OFF", the resume point will not be memorized when the power is turned OFF.

For details on the button operations during playback, refer to "Video Playback Operation" (page 51).

Playing Still Images (JPEG)

Still images stored on the HDD/BD/DVD/SD card can be played back using Playback Navigation.

Playing still images

1 Select the playback location

- HDD : If the current playback location is "BD/DVD" or "SD CARD", press the [HDD] button on the remote control unit to switch it to "HDD".
- BD/DVD : If the current playback location is "HDD" or "SD CARD", press the [BD/SD] button on the remote control unit to switch it to "BD/DVD".
- SD card : If the current playback location is "HDD" or "BD/DVD", press the [BD/SD] button on the remote control unit to switch it to "SD CARD".

2 Set the media

- To play a media other than "HDD", set the media on which the still images are stored.
- BD/DVD : Set a BD or DVD on the disc tray
- SD card : Insert the SD card into the [SD SLOT]

3 Select the still images to play, and press the [▶] button

- Images selected are played back in a slideshow.

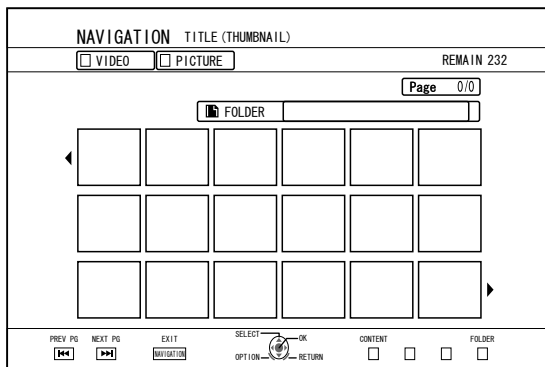

Memo:

- The slide show plays back images according to the date of the files.
- If folders exist, files inside the selected folder will be played.
- You can specify the "REPEAT", "SLIDESHOW INTERVAL" and "SLIDESHOW EFFECTS" settings in the Playback Settings menu. For details, refer to the "REPEAT" (page 56), "SLIDESHOW INTERVAL" (page 56), and "SLIDESHOW EFFECTS" (page 56) items under "Playback Settings".

Enabled button operations during still image playback

■ [▶] button

- Pressing the button when a title/group is selected starts playback of the still images in the title/group in a slideshow.

■ [■] button

- Pressing the button stops the slideshow and displays the Playback Navigation screen.

■ [||] button

- Pressing the button stops the slideshow temporarily.

■ [◀◀] / [▶▶] button

- Pressing the button displays the previous or next still image.

■ [⏻/⏷] button

- Pressing the button ends playback of the still images and turns the power of the unit to "Off".

Memo:

- The display of still images can be zoomed in/out or rotated using the following buttons when the slideshow is paused.
 - [↶] / [BLUE] button
Rotates the still image by 90° in the anti-clockwise direction.
 - [↷] / [YELLOW] button
Rotates the still image by 90° in the clockwise direction.
 - [OK] / [RED] button
Enlarges the still image.
 - [RETURN] / [GREEN] button
Reduces the still image.
 - [▲ / ▼ / ◀ / ▶] button
Moves the display position toward the direction indicated by the button.
- This unit does not have a still image edit feature. Still images cannot be saved when they are zoomed in or rotated.
- Priority of display is given to the media ("BD/DVD" or "SD CARD") that contains playable still images. If both "BD/DVD" and "SD CARD" contain playable videos, priority of display will be given to the most recently used media.

Changing Playback Settings

Displaying the playback settings menu

1 Press the [PB MODE] button on the remote control unit during the playback of a title

- The Settings Menu screen appears.
- The playback settings menu can only be displayed during the playback of a title.
- Only settings that are supported by the current title being played back can be changed in the playback settings menu.
Items displayed in gray cannot be set.

Playback Settings Menu

Audio/subtitle settings

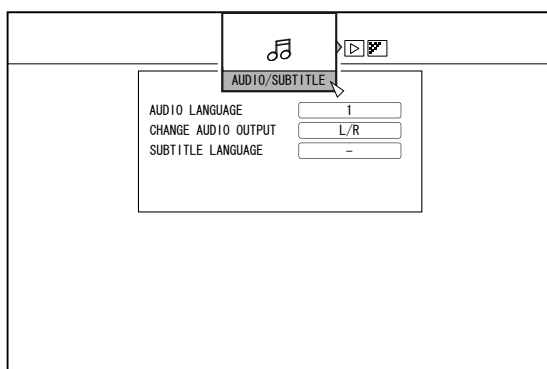

Memo:

- "AUDIO/SUBTITLE" will be displayed only if they are available in the video content. The setting value differs depending on the content. Items that are not available in the content cannot be set.

■ AUDIO LANGUAGE

■ CHANGE AUDIO OUTPUT

■ SIGNAL TYPE (BD-ROM)

- PRIMARY VIDEO
- PRIMARY AUDIO
- SECONDARY VIDEO
- CHANGE SECONDARY VIDEO
- SECONDARY AUDIO
- SECONDARY AUDIO LANGUAGE

■ SUBTITLE LANGUAGE

■ SUBTITLE STYLE

■ CHANGE ANGLE

Playback settings

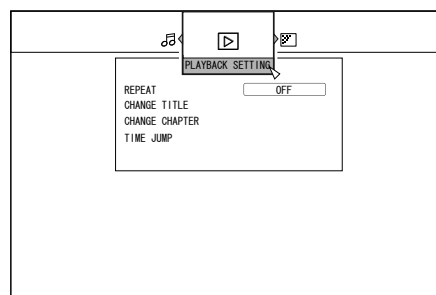

■ REPEAT

The following items can be set.
Items are not displayed if they cannot be set.

Setting Values	Description
OFF	Turns off repeat.
TITLE	Repeats playback of the currently played title.
CHAPTER	Repeats playback of the currently played chapter.
TRACK	Repeats playback of the currently played track.
FOLDER	Repeats playback within the currently played folder.
ALL	Repeats playback of the entire disc.
A-B	Repeats playback of the section between the specified starting and ending points. Pressing the [OK] button specifies the displayed scene as the starting point (Point A). Pressing the [OK] button after forwarding playback specifies the displayed scene as the ending point (Point B).

■ CHANGE TITLE

You can change to a different title by entering the corresponding numeric value. Any value that is larger than the number of titles cannot be entered.

■ CHANGE CHAPTER

You can change to a different chapter by entering the corresponding numeric value. Any value that is larger than the number of chapters cannot be entered.

■ TIME JUMP

You can move to a specific playback position by entering a time. This is not possible if the specified time is not valid.

■ SLIDESHOW INTERVAL

The following items can be set.
3SEC/5SEC/10SEC/20SEC/30SEC modes

■ SLIDESHOW EFFECTS

The following items can be set.

Setting Values	Description
OFF	Turns off slideshow effect.
ON	Turns on slideshow effect. "Fade out" and "Fade in" effects can be applied when switching from one slide to another.

Video settings

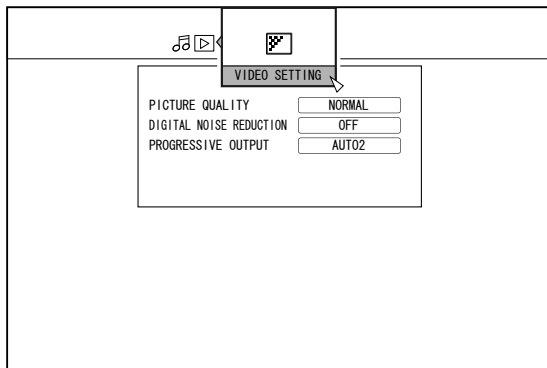

■ PICTURE QUALITY

The following items can be set.

Setting Values	Description
NORMAL	Standard picture quality.
CINEMA	Effective when playing movies.
FINE	Produces sharp images with enhanced outlines.
SOFT	Reduces noise that is prominent in the video image.
USER SETTING	Enables the Details setting. For more details, refer to "DETAIL SETTING".

■ DETAIL SETTING

The following items can be set.

Choose an option and press [OK] to set the respective values.

Setting Values	Description
CONTRAST	A value between "-7" and "+7" can be set.
BRIGHTNESS	A value between "0" and "15" can be set.
SHARPNESS	A value between "-6" and "+6" can be set.
COLOR	A value between "-7" and "+7" can be set.
GAMMA	A value between "0" and "5" can be set.

■ DIGITAL NOISE REDUCTION

The following items can be set.

Setting Values	Description
OFF	Turns off DNR (Digital Noise Reduction).
ON	Reduces noise that is prominent in images of lengthy videos.

■ PROGRESSIVE OUTPUT

The following items can be set.

Setting Values	Description
AUTO1	Displays video images after they are converted according to the film material.
AUTO2	In addition to the "AUTO1" option, support is also provided for progressive videos recorded at 30 frames per second.
VIDEO	Most suitable for video images (TV broadcast, etc.). Select this option when playing videos with significant movements or animated videos.

Editing

Before editing

This unit mainly edits video images stored on the HDD. To edit video images stored in a disc or SD card, do so after importing them to the HDD.

Data on a finalized disc cannot be edited. To edit a finalized disc, you have to either unfinalize the disc, or do so after importing the data to the HDD.

Memo:

- Only discs that are finalized using this unit can be unfinalized.

Editable items for different media

Items that are editable vary according to the type of media on which the video data is stored. For details, refer to the media chart below.

■ Media chart

Editing option	HDD	BD-R (BD-RE)	BD-RE (BD-RE)	DVD-RW/DVD-R	SD	HDD/BD-RE/SD (picture)
Grouping	○	-	-	-	-	-
Changing the Title/Group Name	○	○	○	○	-	-
Deleting a Title/Group	○	○	○	○	-	○
Turning On Title/Group Protection	○	○	○	*1	-	○
Turning Off Title/Group Protection	○	○	○	*1	-	-
Creating a Playlist	○	-	-	-	-	-
Editing a Thumbnail	○	○	○	○	-	-
Editing a Chapter	○	*2	*2	*1,*2	-	-
Delete Scene	○	-	-	-	-	-
Dividing	○	-	-	-	-	-
Changing the Disc Name	-	○	○	○	-	-
Changing the Shooting Date/Time	○	-	-	-	-	-

Memo:

*1 : Supports only the "VR MODE".

*2 : Supports only dividing and combining of chapters.

Entering Characters

Names can be changed or given to stored videos or groups. You can enter characters while referring to the input on the monitor.

Character input screen

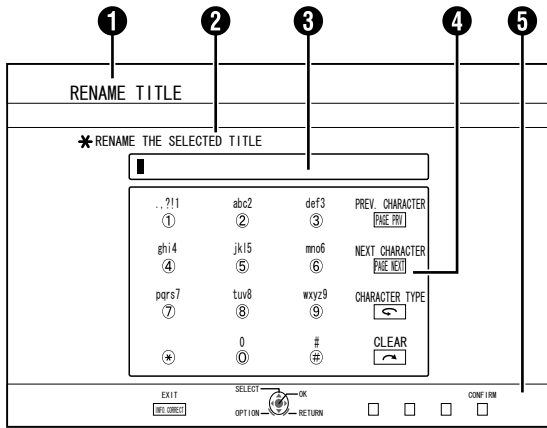

- 1 **Function name field**
- 2 **Screen description**
- 3 **Input window**
Characters entered appear on the input window.
- 4 **Operation guide 1**
The [0]-[9], [*], [#], [PAGE PRV], [↶], and [↷] buttons are displayed.
- 5 **Operation guide 2**
[▲/▼/◀/▶], [OK], [RETURN], [OPTION], [BLUE], [RED], [GREEN] and [YELLOW] buttons are displayed.
- 6 **Character input keyboard**
A character input keyboard appears during input of symbol. You can enter characters by selecting them accordingly from the keyboard.

Entering characters

- 1 Enter characters using the [0]-[9], [*] or [#] buttons
- 2 After character input is complete, press the [YELLOW] button

Memo:

- Switch between alphanumeric and symbol input by pressing the [↶] button.
- For details on the correspondence between each button and the input characters, refer to the "Character List".
- Press the [↷] button to delete an input character. Press and hold down the [↷] button to delete all input characters.
- Pressing the [RETURN] button calls up the confirmation screen to cancel character input. To cancel character input and return to the initial screen, select "YES" and press the [OK] button. To return to the character input screen, select "NO" and press the [OK] button.
- Up to about 20 alphanumeric characters can be displayed on the disc menu of BDMV and DVD-VIDEO. (The number of characters that can be displayed varies with the character.)

Note:

- If you switch the screen display before confirming the input characters, a message will appear on the screen. To cancel character input and proceed to switch the screen display, select "YES" and press the [OK] button. To return to the character input screen, select "NO" and press the [OK] button.
- If the converted characters exceed the maximum number of input characters, a message will appear on the screen. Select "OK" and press the [OK] button to delete the excess characters and to input the remaining ones. Select "RETURN" and press the [OK] button to restore the unconfirmed characters.
- No more characters can be input if the maximum character limit has been reached.

Character List

[1]	.	,	?	!	1	-	()	@	/	:	_																					
[2]	a	b	c	A	B	C	ä	æ	â	à	á	â	ã	ç	Ä	Æ	Å	À	Á	Â	Ã	Ç	2										
[3]	d	e	f	D	E	F	è	é	ê	ë	ð	È	É	Ê	Ë	Ð	3																
[4]	g	h	i	T	G	H	ì	í	î	ï	ì	í	î	ï	4																		
[5]	j	k	l	J	K	L	£	5																									
[6]	m	n	o	M	N	O	ö	ø	ò	ó	ô	õ	ñ	Ö	Ø	Ò	Ó	Ô	Õ	Ñ	6												
[7]	p	q	r	s	P	Q	R	S	ÿ	ß	\$	7																					
[8]	t	u	v	T	U	V	ù	ú	û	ü	Û	Ú	Ü	8																			
[9]	w	x	y	z	W	X	Y	Z	ý	þ	Ý	þ	9																				
[0]	0	.	@	-	_	/	:	!	?	~	()	*	#	+	,	^	;	<	=	>	\$	¥	%	&	[]	'	`	{		}	*1
[*]	,	.	-	~	!	?	*1																										

*1: Single-byte space

*2: Press the [#] button to return to the previous input character.

Grouping

Multiple titles stored on the HDD can be combined into a group.

Memo:

- Only video data stored on the HDD can be grouped.

Grouping

1 Press the [NAVIGATION] button on the remote control unit

- The Playback Navigation screen appears.

2 Select the titles or groups to be grouped, and press the [MARK] button

- Pressing the [MARK] button adds a check mark to the selected titles/groups.
All titles and groups with the check mark will be grouped together.

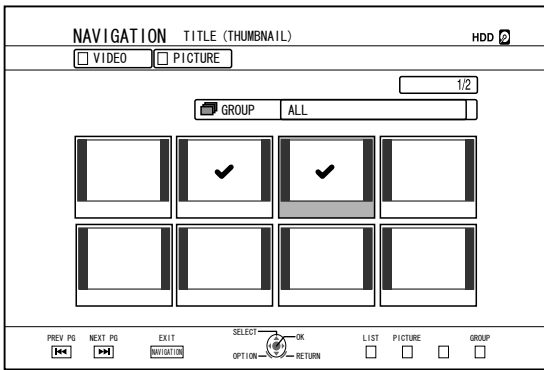

3 Press the [OPTION] button on the remote control unit

- A pop-up option list appears.

4 Select “GROUP”, and press the [OK] button

- A grouping confirmation screen appears.

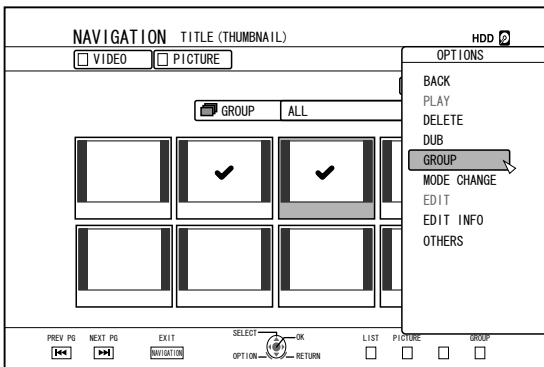

5 Select “GROUP”, and press the [OK] button

- The selected titles and groups are now grouped together.

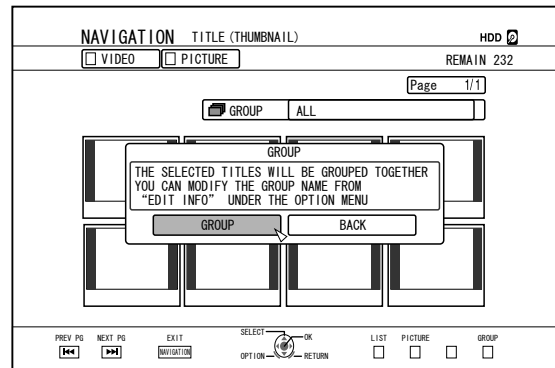

Memo:

- To cancel grouping, select “BACK” and press the [OK] button.
- Alternatively, you can press the [RETURN] button to cancel grouping and return to the initial screen.

Ungrouping

1 Press the [NAVIGATION] button on the remote control unit

- The Playback Navigation screen appears.

2 Select the group to ungroup, and press the [OPTION] button

- A pop-up option list appears.

3 Select “UNGROUP”, and press the [OK] button

- An ungroup confirmation screen appears.

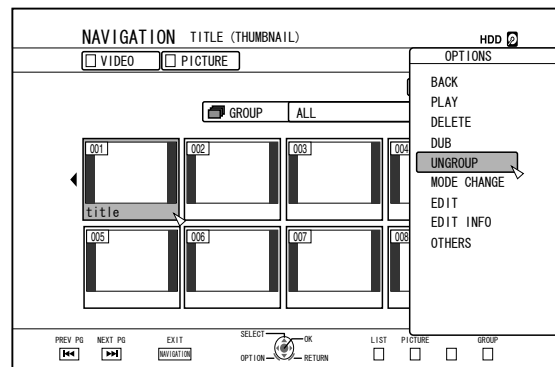

Memo:

- You cannot ungroup multiple groups at the same time. When multiple groups are selected, the “UNGROUP” item does not appear in the option list.

4 Select “YES”, and press the [OK] button

- All titles within the selected group are ungrouped.

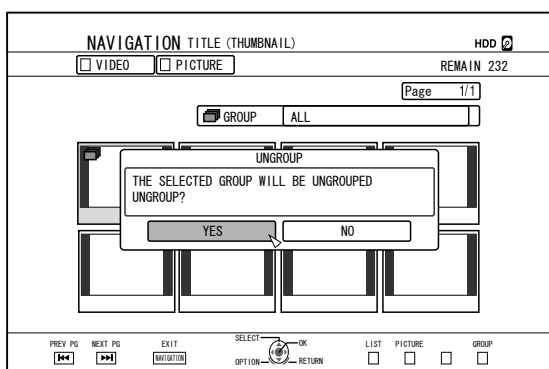

Memo:

- To cancel ungrouping, select “NO” and press the [OK] button.
- Alternatively, you can press the [RETURN] button to cancel ungrouping and return to the initial screen.

Excluding from a group

You can select titles and exclude them from a group.

1 Press the [NAVIGATION] button on the remote control unit

- The Playback Navigation screen appears.

2 Select the titles to exclude from the group, and press the [MARK] button

- Pressing the [MARK] button adds a check mark to the selected titles/groups. All titles with the check mark will be excluded from the group.

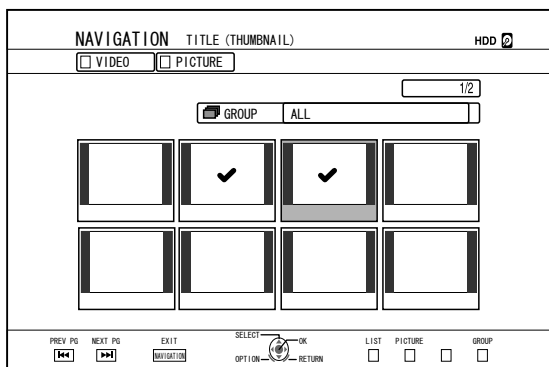

3 Press the [OPTION] button on the remote control unit

- A pop-up option list appears.

4 Select “DO NOT GROUP”, and press the [OK] button

- A confirmation screen for group exclusion appears.

5 Select “YES”, and press the [OK] button

- The selected titles are now excluded from the group.

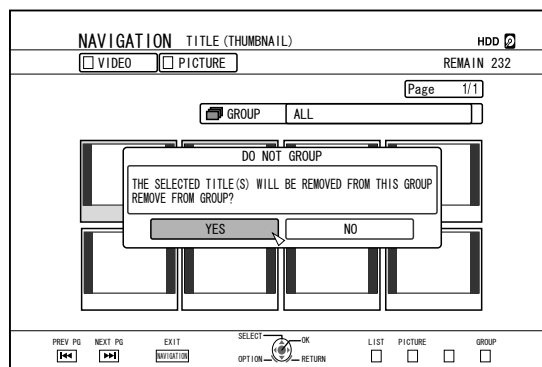

Memo:

- To cancel, select “NO” and press the [OK] button.
- Alternatively, you can press the [RETURN] button to cancel group exclusion and return to the initial screen.

Changing the Title/Group Name

The saved title/group name can be changed as follows.

Memo:

- A title/group name can be added to video data stored on the HDD, BD-RE, BD-R, DVD-RW, or DVD-R, and the name can be changed.
- Video data stored on a DVD-RW or DVD-R in the Video mode cannot be changed.

1 Press the [NAVIGATION] button on the remote control unit

- The Playback Navigation screen appears.

2 Select the title/group for which the name is to be changed, and press the [OPTION] button

- A pop-up option list appears.

3 Select “EDIT INFO”, and press the [OK] button

- An information editing screen appears.

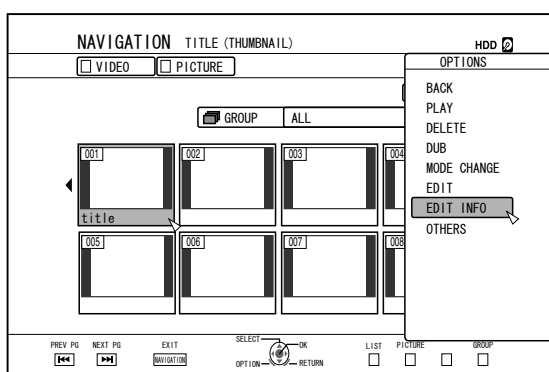

4 Select “MODIFY TITLE NAME” or “MODIFY GROUP NAME”, and press the [OK] button

- A title/group name modifying screen appears.

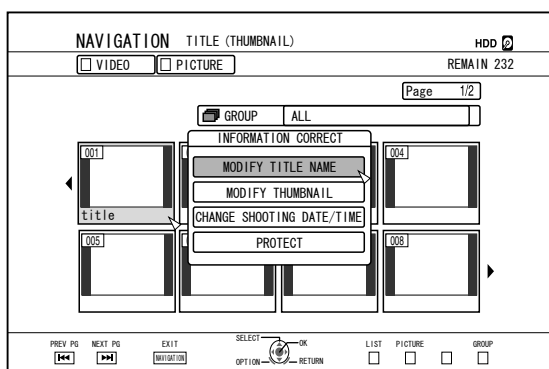

5 Modify the title/group name

- The modified title/group name is now saved.

Memo:

- For details on the method of character input, refer to “Entering Characters” (page 59).

Deleting a Title/Group

Titles/groups can be deleted. When you delete a group, all titles contained within the group are deleted.

Memo:

- When a title/group is deleted from the HDD, BD-RE, or DVD-RW, the remaining space on the media increases according to the size of the deleted title/group. Deleting a title/group from a BD-R or DVD-R does not increase the amount of available space on the disc.

1 Press the [NAVIGATION] button on the remote control unit

- The Playback Navigation screen appears.

2 Select the titles/groups to delete, and press the [OPTION] button

- A pop-up option list appears.

3 Select “DELETE”, and press the [OK] button

- A confirmation screen for title/group deletion appears.

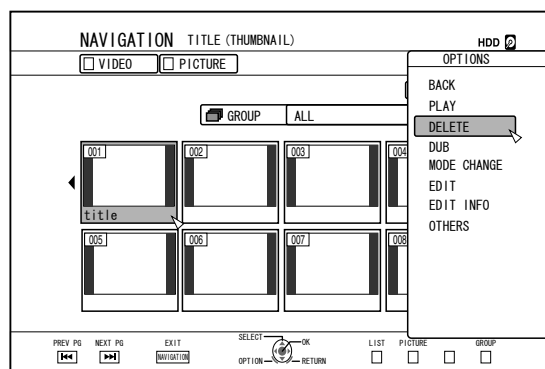

4 Select “DELETE”, and press the [OK] button

- The selected titles/groups are deleted.

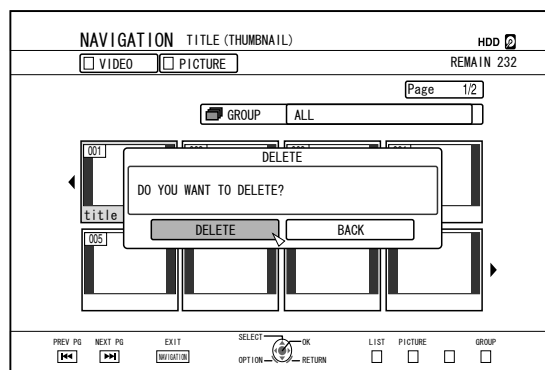

Memo:

- To cancel the title/group deletion operation, select “BACK” and press the [OK] button.
- Alternatively, you can press the [RETURN] button to cancel the deletion operation and return to the initial screen.

Turning On Title/Group Protection

Titles/groups can be protected.

Editing and deletion cannot be performed on protected titles/groups.

- Title/group protection can be turned on for video data stored on the HDD, BD-RE (BD-RE), BD-R (BD-RE), and DVD-RW (VR).

1 Press the [NAVIGATION] button on the remote control unit

- The Playback Navigation screen appears.

2 Select the titles/groups to be protected, and press the [OPTION] button

- A pop-up option list appears.

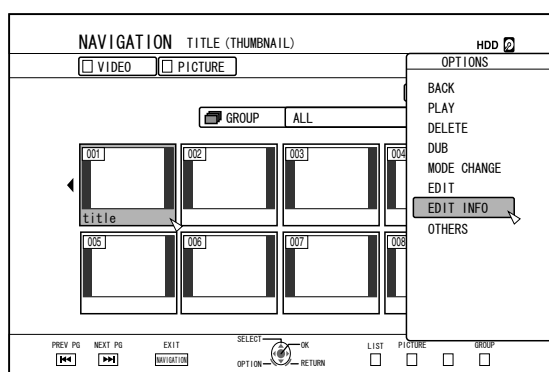

3 Select "EDIT INFO", and press the [OK] button

- An information editing screen appears.

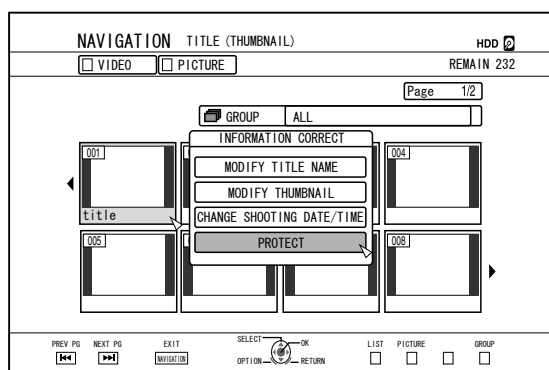

4 Select "PROTECT", and press the [OK] button

- If only a single title was selected in step 2, a confirmation screen for title protection will appear.

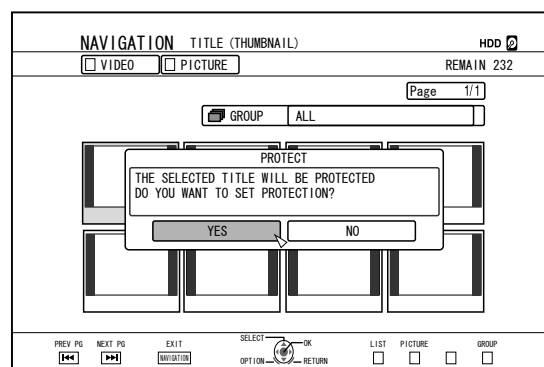

- If multiple titles or groups were selected in step 2, "PROTECT" and "UNPROTECT" items will be displayed.

5 Select "YES" or "PROTECT", and press the [OK] button

- The selected titles/groups are now protected.

Memo:

- All selected titles and groups will be protected when multiple titles or groups are selected.
- To turn off the title/group protection, select "NO" and press the [OK] button.
- Alternatively, you can press the [RETURN] button to turn off the protection and return to the initial screen.

Turning Off Title/Group Protection

Protection of a title/group can be turned off. Titles/groups can be edited and deleted after their protection is turned off.

- Title/group protection can be turned off for video data stored on the HDD, BD-RE (BD-RE), BD-R (BD-RE), and DVD-RW (VR).

1 Press the [NAVIGATION] button on the remote control unit

- The Playback Navigation screen appears.

2 Select the titles/groups to turn off protection for, and press the [OPTION] button

- A pop-up option list appears.

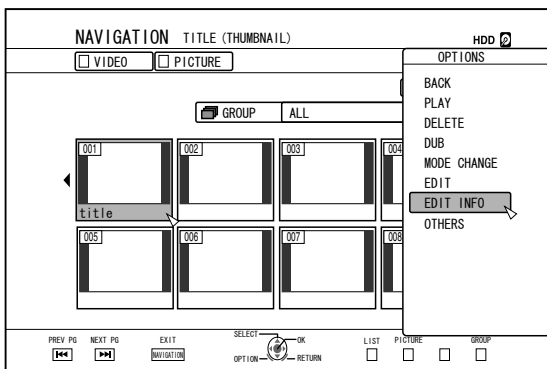

3 Select “EDIT INFO”, and press the [OK] button

- An information editing screen appears.

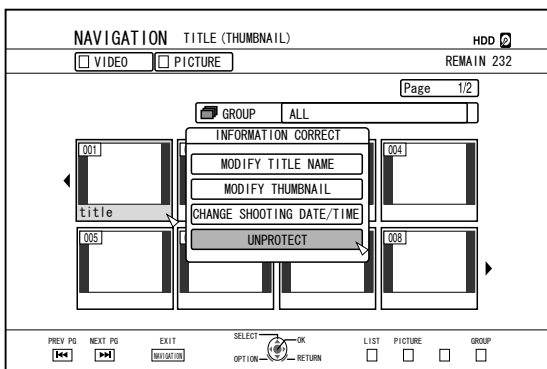

4 Select “UNPROTECT”, and press the [OK] button

- If only a single title was selected in step 2, a confirmation screen for turning off protection will appear.

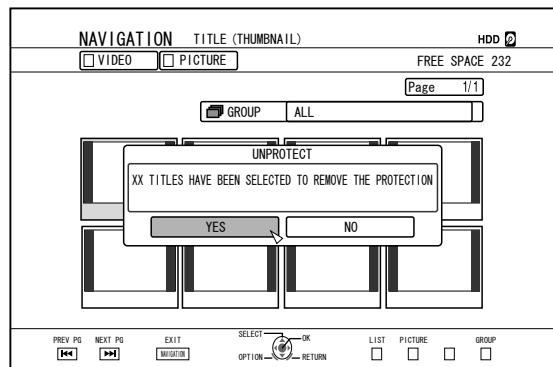

- If multiple titles or groups were selected in step 2, “UNPROTECT” and “PROTECT” items will be displayed.

5 Select “YES”, and press the [OK] button

- Protection of the selected titles/groups is now turned off.

Memo:

- Protection will be turned off from all selected titles and groups when multiple titles or groups are selected.
- If you do not want to turn off the title/group protection, select “NO” and press the [OK] button.
- Alternatively, you can press the [RETURN] button to cancel protection removal and return to the initial screen.

Creating a Playlist

A playlist can be created from the video titles on the HDD.

- Playlists can only be created for titles that are stored on the HDD.

Playlist : Enables you to create a program by selecting chapters from a specific title and editing their playback sequence.

Memo:

- The playlist created comes in handy during playback and dubbing to a disc.

Creating a Playlist

1 Press the [NAVIGATION] button on the remote control unit

- The Playback Navigation screen appears.

2 Select the title for which a playlist is to be created, and press the [OPTION] button

3 Select "EDIT", and press the [OK] button

- The Edit menu screen appears.

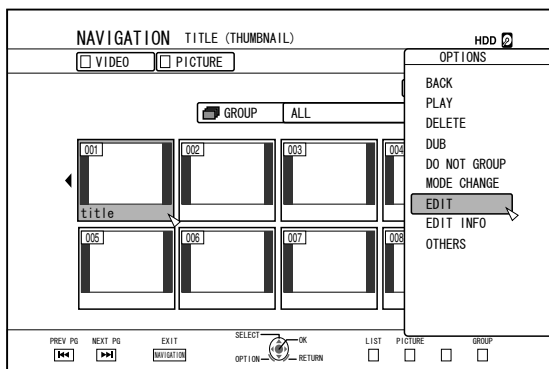

4 Select "PLAYLIST EDIT", and press the [OK] button

- The playlist edit screen appears.

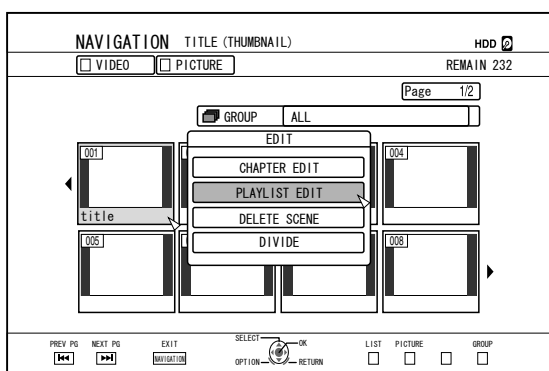

5 Edit the playlist accordingly by selecting chapters from the source title according to your preference

- Edit the playlist.
For details, refer to "Editing the playlist".

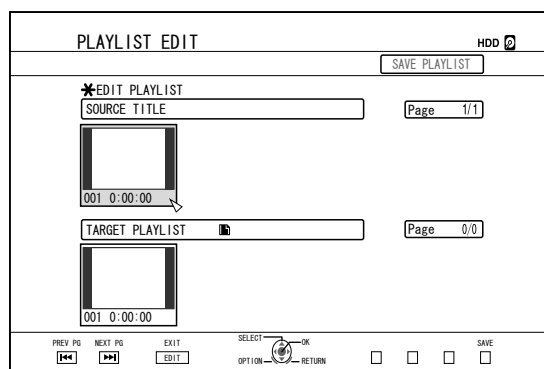

6 Press the [YELLOW] button on the remote control unit

- A playlist is created.

Editing the playlist

■ **Chapter insertion**

- ① Select the chapter to insert from the thumbnails of the "SOURCE TITLE", and press the [OK] button
- ② Select the position to insert the chapter from the "TARGET PLAYLIST", and press the [OK] button

■ **Chapter deletion**

- ① Select the chapter to delete from the thumbnails of the "TARGET PLAYLIST", and press the [OK] button
- ② Select "DELETE", and press the [OK] button

■ **Entering the playlist name**

- ① Select "TARGET PLAYLIST", and press the [OK] button.
- ② Enter a playlist name, and press the [OK] button

Memo:

- For details on the method of character input, refer to "Entering Characters".

Note:

- Deleting the original title list will cause the playlist to be deleted as well.
Editing the original title list, or changing the recording mode may cause the playlist to be deleted.

Editing a Thumbnail

Thumbnails (index images) can be changed to a still image according to your preference.

Memo:

- Thumbnails of titles stored on the HDD, BD-RE, BD-R, DVD-RW, and DVD-R can be edited.
- However, thumbnails of titles that are stored on an SD card or finalized disc cannot be edited.

1 Press the [INFORMATION CORRECT] button on the remote control unit

- An information editing screen appears.

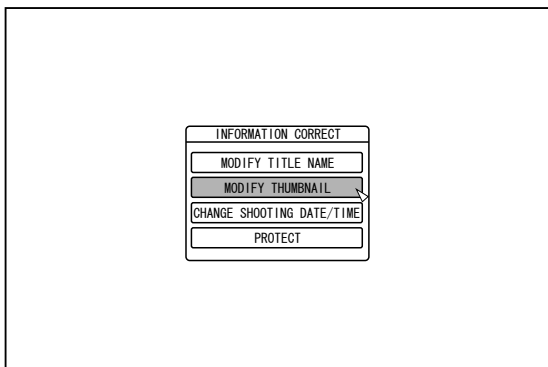

2 Select “MODIFY THUMBNAIL”, and press the [OK] button

- A thumbnail modification screen appears.

3 Play the video, and press the [III] button to stop at the scene you want to use as thumbnail display

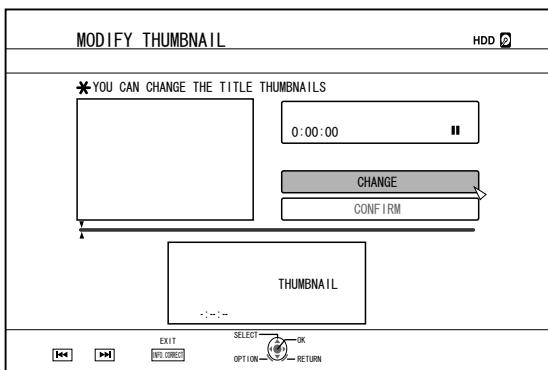

Memo:

- For details on how to play videos, refer to “Video Playback Operation” (page 51).

4 Select “CHANGE”, and press the [OK] button

- The displayed still image now becomes the thumbnail image.

5 Select “CONFIRM”, and press the [OK] button

- Doing so ends the editing of thumbnails.

Memo:

- You can also display the thumbnail modification screen from the Playback Navigation screen.

- 1 Select the title for which the thumbnail is to be changed, and press the [OPTION] button
- 2 Select “EDIT INFO”, and press the [OK] button
- An information editing screen appears.

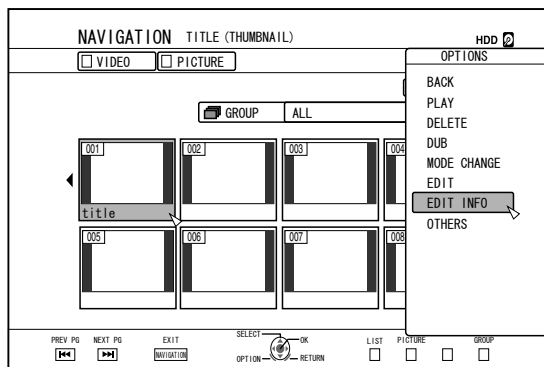

3 Select “MODIFY THUMBNAIL”, and press the [OK] button

- A thumbnail modification screen appears.

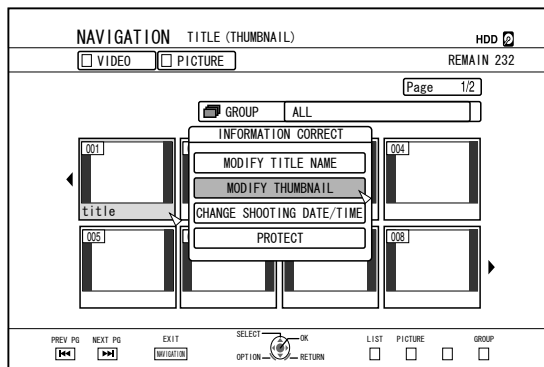

Editing a Chapter

Creating a chapter mark for a saved title enables you to find a specific scene within the title.

Memo:

- All chapter editing functions can be performed on titles stored on the HDD.
Titles stored on a BD-RE (BD-RE), BD-R (BD-RE), DVD-R (VR), or DVD-RW (VR) only allow chapters to be divided or combined.
- The chapters of titles that are stored on an SD card or finalized disc cannot be edited.
- Also, protected titles cannot be edited. To perform chapter edit of a title, turn off the protection.

For details on turning off protection of a title, refer to “Turning Off Title/Group Protection” (page 64).

Chapter edit functions

- Chapter mark insertion (divide chapter)
Divides a chapter by inserting a chapter mark.
- Chapter mark deletion (combine chapters)
Combine chapters by deleting the chapter mark.
- Chapter deletion
Deletes a specified chapter.

Editing a chapter

1 Press the [EDIT] button on the remote control unit

- The Edit menu screen appears.

2 Select “CHAPTER EDIT”, and press the [OK] button

- The title screen appears.

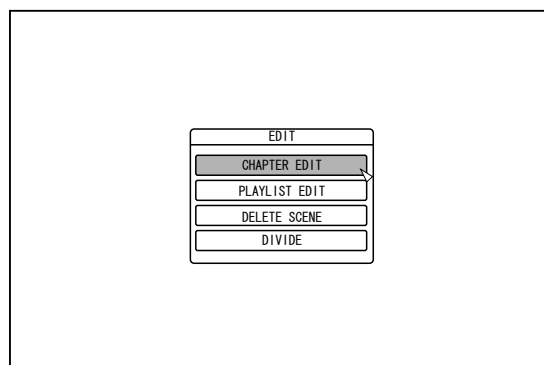

3 Select a title, and press the [OK] button

Memo:

- The chapter edit screen can also be called up from the Playback Navigation screen.

① Select the title to perform chapter edit, and press the [OPTION] button

② Select “EDIT”, and press the [OK] button

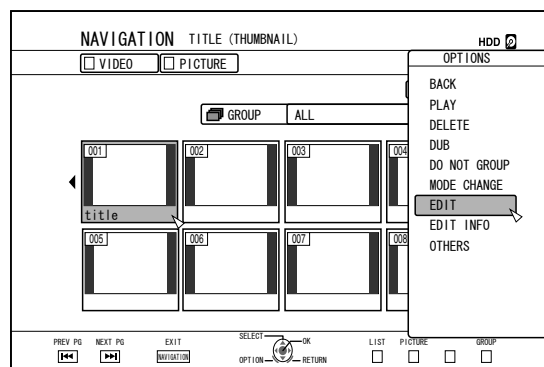

③ Select “CHAPTER EDIT”, and press the [OK] button

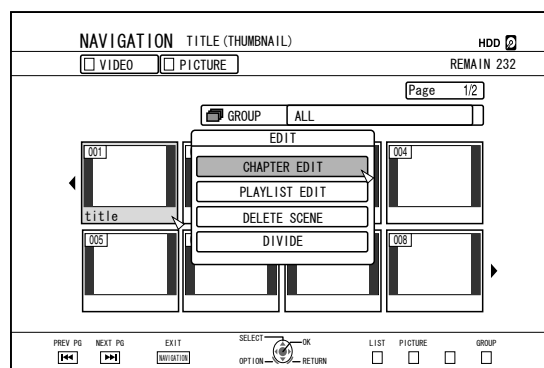

- For details on how to play videos, refer to “Video Playback Operation” (page 51).

- Frame movement on the Chapter Edit screen can only be performed one frame at a time regardless of the “STILL MODE” (page 77) setting.

Editing a Chapter (Continued)

■ Chapter mark insertion (divide chapter)

- 1 Play the video, and press the [||] button to stop at the scene you want to add a chapter mark
 - 2 Press the [MARK] button on the remote control unit
- A chapter mark is inserted into the paused scene.

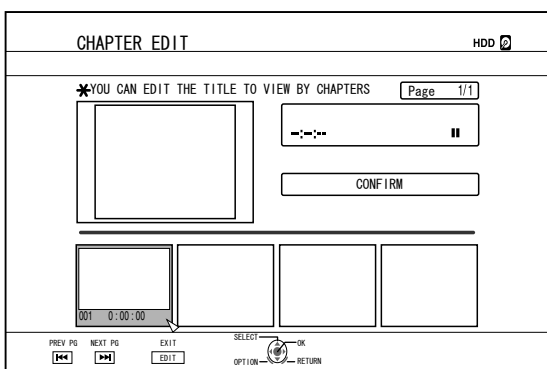

Memo:

- The chapter is now divided into two parts at the position of the chapter mark.

■ Chapter mark deletion (combine chapters)

- 1 Play the video, and press the [||] and [◀/▶] buttons to display the scene for which you want to delete the chapter mark
 - 2 Press the [MARK] button on the remote control unit
- A confirmation screen for deleting the chapter mark appears.

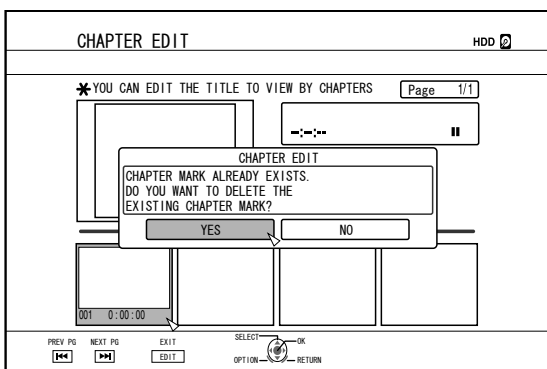

3 Select "YES", and press the [OK] button

- The chapter mark is deleted from the selected scene.

Memo:

- The chapters before and after the position of the chapter mark are now combined.
- Pressing the [▶▶/◀◀] button displays the next/previous page.

■ Deleting a video chapter

- 1 Select the chapter for which you want to delete the video from the chapter edit screen
 - 2 Press the [DELETE] button on the remote control unit
- A confirmation screen for deleting the chapter appears.

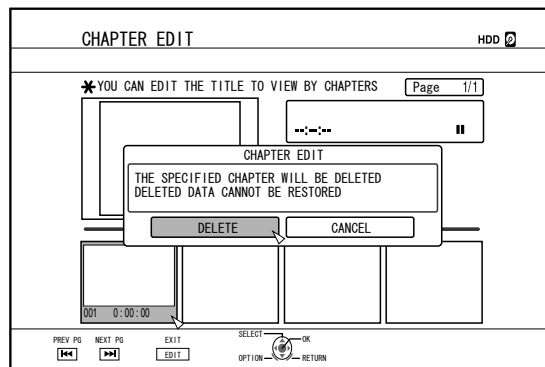

3 Select "DELETE", and press the [OK] button

- The selected video chapter is deleted.

Note:

- Videos cannot be restored once they are deleted.
- Deletion of the video may fail if the length of the chapter is too short.

Chapter options

Pressing the [OPTION] button on the remote control when the Chapter Edit screen is displayed enables you to perform the following editing operations.

■ Combining with previous chapter

- Combines the selected chapter with the previous chapter.
 - ① Select a chapter, followed by "COMB. W/PREV CH", and press the [OK] button
 - Combines chapters.

■ Combining with next chapter

- Combines the selected chapter with the next chapter.
 - ① Select a chapter, followed by "COMB. W/NEXT CH", and press the [OK] button
 - Combines chapters.

■ Combining all chapters

- Combines all chapters.
 - ① Select "COMB. ALL CHAP.", and press the [OK] button
 - A confirmation screen for combining all the chapters is displayed.
 - ② Select "YES", and press the [OK] button
 - Combines all the chapters.

Dividing

You can select a saved title and divide it into two titles.

Memo:

- Dividing can only be applied to titles stored on the HDD.
- Titles that are protected cannot be divided. To divide a title, turn off the protection.

For details on turning off the title protection, refer to “Turning Off Title/Group Protection” (☞ page 64) .

Dividing

1 Press the [EDIT] button on the remote control unit

- The Edit menu screen appears.

2 Select “DIVIDE”, and press the [OK] button

- The title screen appears.

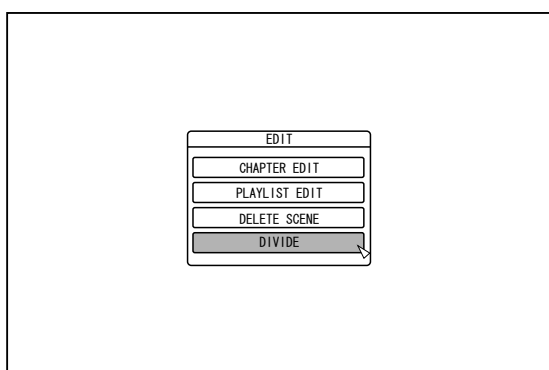

3 Select a title, and press the [OK] button

4 Play the video, and press the [■] button at the scene where you want to perform dividing

5 Select “DIVIDING POINT”, and press the [OK] button

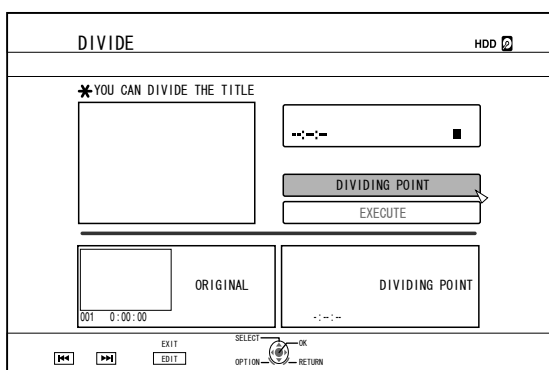

Memo:

- For details on how to play videos, refer to “Video Playback Operation” (☞ page 51) .
- Frame movement on the Chapter Edit screen can only be performed one frame at a time regardless of the “STILL MODE” (☞ page 77) setting.

6 Select “EXECUTE”, and press the [OK] button

- A confirmation screen for performing dividing appears.

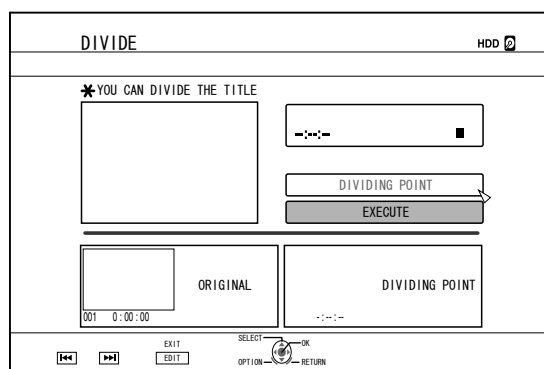

7 Select “DIVIDE”, and press the [OK] button

- Dividing starts.

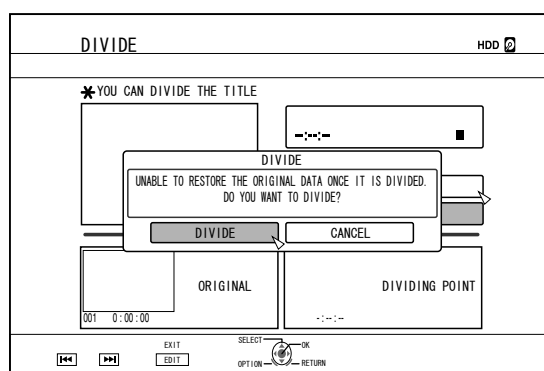

Dividing (Continued)

Memo:

- To cancel the dividing operation, select “CANCEL” and press the [OK] button.
- Alternatively, you can press the [RETURN] button to cancel the divide operation and return to the initial screen.
- The dividing edit screen can also be called up from the Playback Navigation screen.
 - 1 Select the titles to divide, and press the [OPTION] button
 - 2 Select “EDIT”, and press the [OK] button

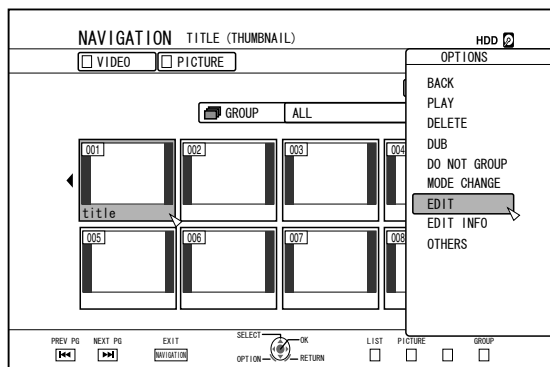

- 3 Select “DIVIDE”, and press the [OK] button

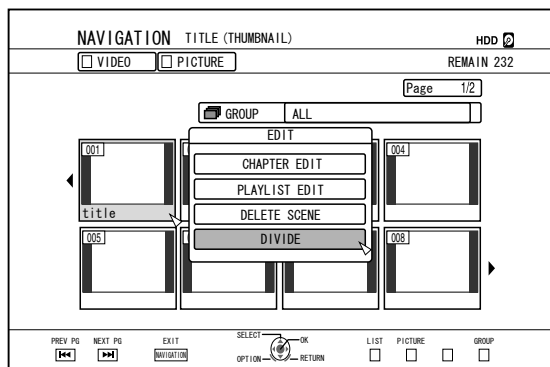

Delete Scenes

Unwanted scenes of a saved title can be deleted. Doing so helps to increase the free space on the disc.

Memo:

- Deleting scenes can only be applied to titles stored on the HDD.
 - Titles that are protected cannot be deleted. To enable scene delete of a title, turn off the protection.
- For details on turning off the title protection, refer to “Turning Off Title/Group Protection” (page 64).
- HD content for which the delete scene operation has been applied cannot be dubbed to BDMV. Perform seamless conversion before starting a dubbing operation.

For details, refer to “Mode conversion” (page 73).

Delete Scenes

- 1 Press the [EDIT] button on the remote control unit
 - The Edit menu screen appears.
- 2 Select “DELETE SCENE”, and press the [OK] button
 - Displays the Title Display screen.

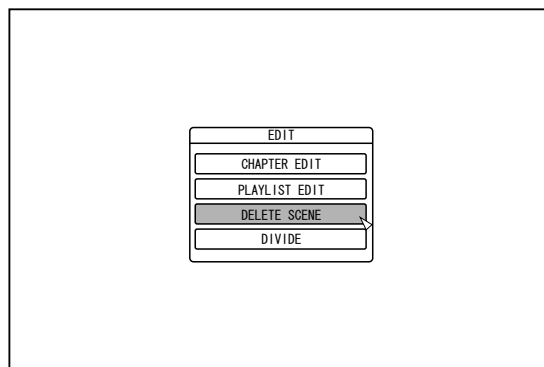

- 3 Select a title, and press the [OK] button
- 4 Edit the delete scene section

Follow the steps below to edit the section for which delete scene is to be applied.

- ① Play the video, and press the [PAUSE] button at the point where you want to start the delete operation
- ② Select “START”, and press the [OK] button

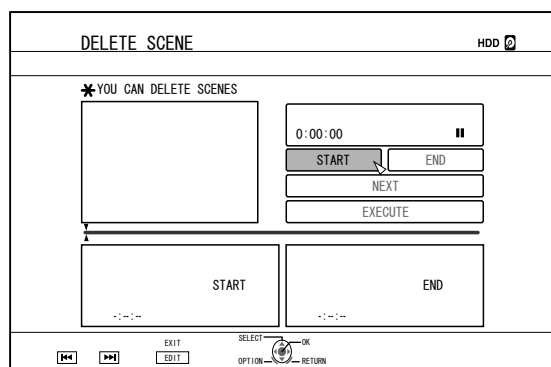

- ③ Play the video, and press the [PAUSE] button at the point where you want to end the delete operation
- ④ Select “END”, and press the [OK] button

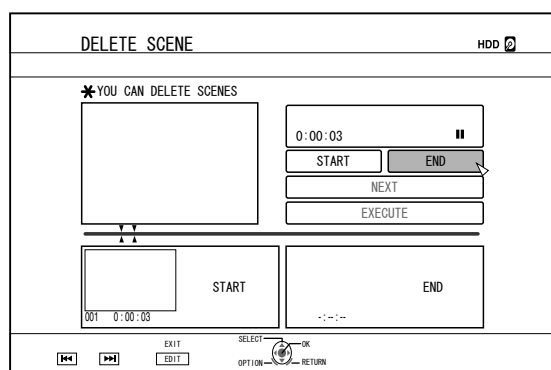

- ⑤ To continue specifying other sections to delete, select “NEXT”, and press the [OK] button

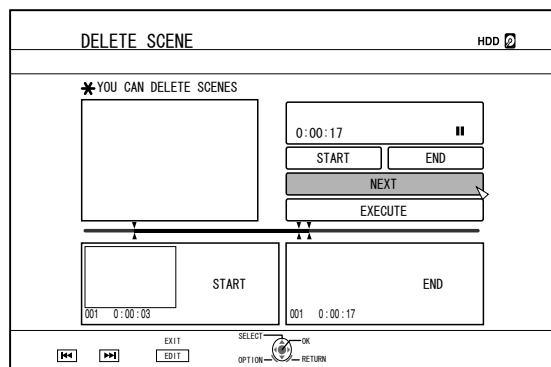

- ⑥ Repeat Steps 1 to 4 to specify the sections to delete

Memo:

- For details on how to play videos, refer to “Video Playback Operation” (page 51).
- Frame movement on the Chapter Edit screen can only be performed one frame at a time regardless of the “STILL MODE” (page 77) setting.

- 5 Select “EXECUTE”, and press the [OK] button
 - A confirmation screen for performing scene delete appears.
- 6 Select “EXECUTE”, and press the [OK] button
 - Scene deletion starts.

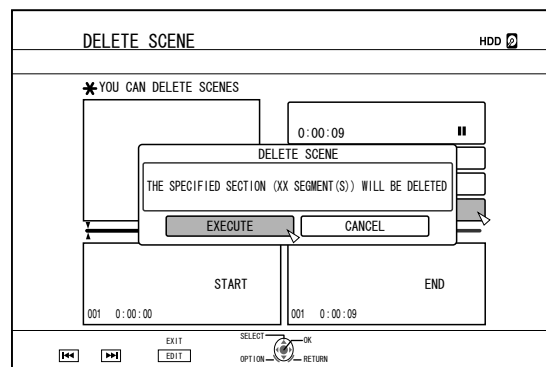

Memo:

- To cancel the delete scene operation, select “CANCEL” and press the [OK] button.
- Alternatively, you can press the [RETURN] button to cancel delete scene and return to the initial screen.

Changing the Disc Name

The name of a BD or DVD disc can be changed as follows.

- 1 Set the BD or DVD for which the disc name is to be changed on the disc tray
- 2 Press the [MEDIA MANAGE] button on the remote control unit
 - The Media Management menu screen appears.

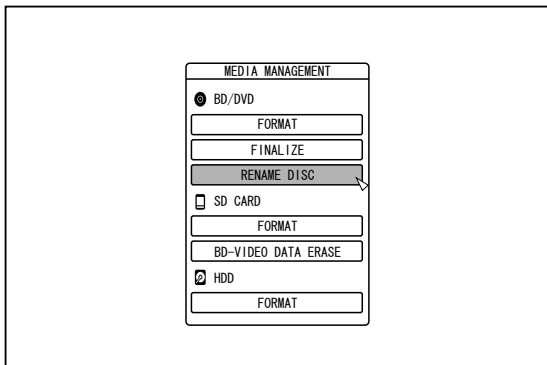

- 3 Select "RENAME DISC" under "BD/DVD", and press the [OK] button
 - A disc name modification screen appears.

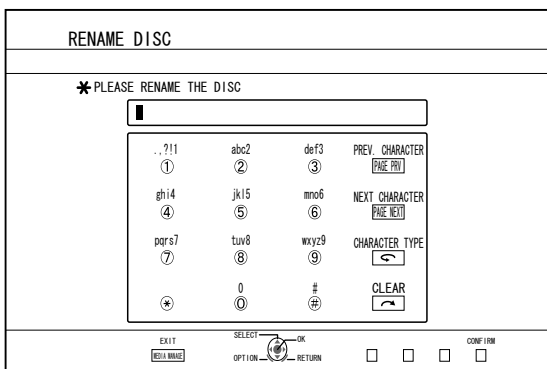

4 Modifying the Disc Name

- The new disc name is now saved.

Memo:

- For details on the method of character input, refer to "Entering Characters" (page 59).

Changing the Shooting Date/Time

The date/time of the stored video can be changed as follows.

- The shooting date/time of videos stored on the HDD can be changed.
- 1 Press the [INFORMATION CORRECT] button on the remote control unit
 - An information correct screen appears.

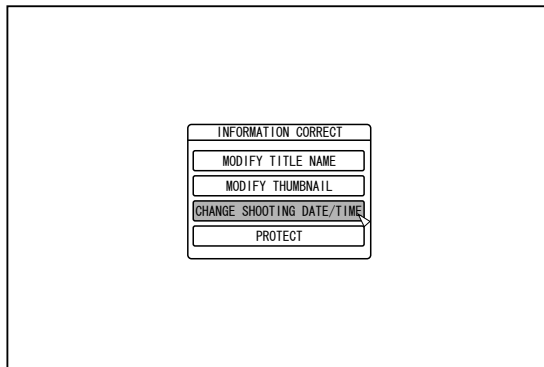

- 2 Select "CHANGE SHOOTING DATE/TIME", and press the [OK] button
 - A thumbnail screen appears.

- 3 Select the title for which the shooting date/time is to be changed, and press the [OK] button
 - The screen for changing the shooting date/time appears.

4 Change the shooting date/time

- Perform the following steps to change the shooting date/time.

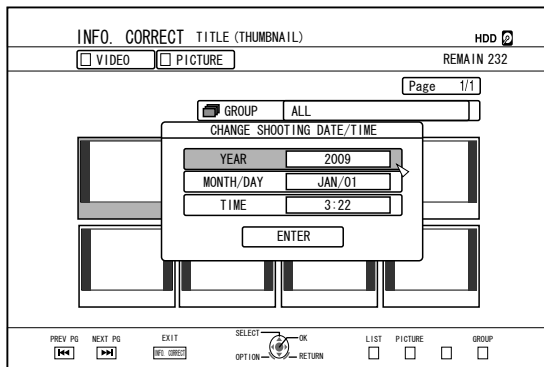

- 1 Use the [▲] and [▼] buttons to move the cursor to the item you want to change
- 2 Press the [OK] button to display the pop-up screen
- 3 Use the [▲] and [▼] buttons to select a desired value
- 4 Press the [OK] button to choose the value
- 5 Repeat Steps 1 to 4 to change settings for any desired items

5 Select “ENTER”, and press the [OK] button

- The modified shooting date/time is saved.

Memo:

- Alternatively, you can press the [RETURN] button to cancel the shooting date/time modification and return to the initial screen.
- The shooting date/time modification will not be reflected on a title that was dubbed.
- Pressing the [OPTION] button in the playback navigation screen instead of the [INFORMATION CORRECT] button will also display the shooting date/time edit screen.
 - ① Select the title for which the shooting date/time is to be changed, and press the [OPTION] button
 - ② Select “EDIT INFO”, and press the [OK] button

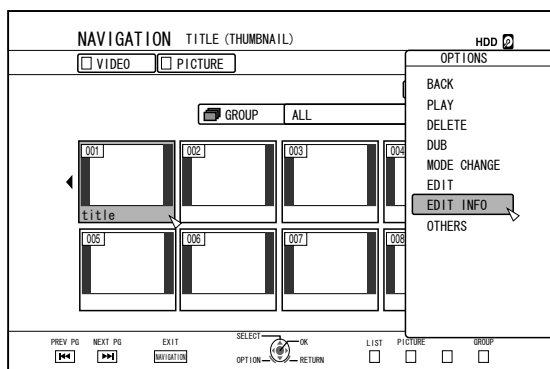

③ Select “CHANGE SHOOTING DATE/TIME”, and press the [OK] button

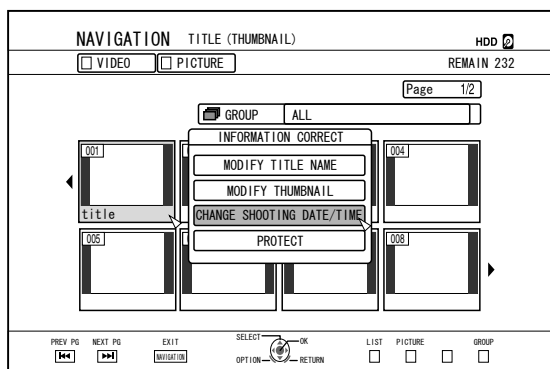

Mode conversion

You can convert HD quality video titles saved on the HDD if they are recorded in the DR, AVC, AF, AN, AL, or AE mode.

- Seamless conversion** : Seamless conversion can be performed to enable smooth playback of joined scenes after dubbing to a BD. (Titles recorded in the DR recording mode ⇒ seamless)
- Recording mode conversion** : Enables conversion of recording mode. (Titles recorded in the DR, AVC, AF, AN, AL, or AE mode ⇒ AF/AN/AL/AE/XP/SP/LP/EP)

Memo:

- As seamless conversion does not re-encode video and audio, there is no deterioration in the image quality.
- Re-encoding is performed during recording mode conversion.
- Only titles that are recorded in the DR mode enable conversion to the XP/SP/LP/EP mode.
- To apply “MODE CHANGE” after turning off the power, select “AFTER POWER OFF” for “START METHOD” under the “MODE CHANGE”.

Note:

- When seamless conversion is performed, the chapters (excluding joints of scenes) will be combined. To divide the chapters, insert chapter marks after seamless conversion. For details on dividing the chapters, refer to “Chapter mark insertion (divide chapter)” (page 68) .

1 Press the [NAVIGATION] button on the remote control

2 Select a title/group, and press the [OPTION] button

3 Select “MODE CHANGE” from the Option menu, and press the [OK] button

- The “MODE CHANGE” screen appears.

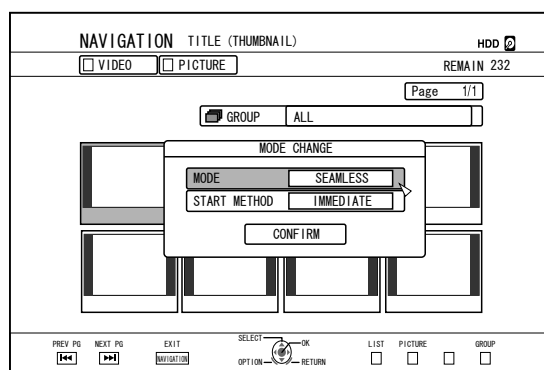

4 Select a recording mode from “MODE CHANGE”, and press the [OK] button

5 Select “CONFIRM”, and press the [OK] button

Changing Settings of this Unit

Settings changed in the Settings Menu screen are stored on this unit even when its power is turned off.

Displaying the Settings Menu

1 Press the [SET UP] button on the remote control unit

- The Settings Menu screen appears.

Memo:

- When playback is in progress, pressing the button stops it and displays the Settings Menu screen.
- The cursor position appears at the position when the screen was last closed.

Setting Menu List

The following items can be set. Items that cannot be set cannot be selected.

SETUP	(page 75)
AUTO POWER (OFF)	(page 75)
REMOTE CONTROL CODE	(page 75)
CLOCK SET/DISPLAY	(page 75)
CLOCK SET	(page 75)
DATE DISPLAY	(page 75)
TIME DISPLAY CHOICE	(page 75)
PANEL DISPLAY BRIGHTNESS	(page 75)
DIMMER (POWER ON)	(page 75)
DIMMER (POWER OFF)	(page 76)
QUICK STARTUP	(page 76)
BUZZER OUTPUT	(page 76)
REMOTE CONTROL SENSOR TONE	(page 76)
ALERT/WARNING TONE	(page 76)
DEFAULT SETTING	(page 76)
PLAYBACK SETTING	(page 76)
BD-/DVD-VIDEO PB SETTING	(page 76)
BD-VIDEO RATINGS	(page 76)
COUNTRY CODE	(page 76)
AUDIO LANGUAGE	(page 76)
SUBTITLE LANGUAGE	(page 76)
MENU LANGUAGE	(page 76)
RESUME	(page 77)
STILL MODE	(page 77)
SEAMLESS PLAYBACK	(page 77)
RECORD	(page 77)
XP MODE RECORDING AUDIO	(page 77)
HIGH-SPEED DUBBING	(page 77)
VIDEO MODE RECORDING ASPECT	(page 77)
DISC RECORDING AUDIO	(page 78)
AUDIO	(page 78)
DYNAMIC RANGE CONTROL	(page 78)

DOWN MIX	(page 78)
DIGITAL OUT	(page 78)
PCM DOWN SAMPLING	(page 78)
Dolby Digital	(page 78)
Dolby Digital Plus/TrueHD	(page 78)
DTS	(page 78)
DTS-HD	(page 79)
AAC	(page 79)
DV IN AUDIO SETTING	(page 79)
BD MIX SOUND	(page 79)
DISPLAY	(page 79)
ON SCREEN GUIDE	(page 79)
BLUE BACK	(page 79)
SCREEN SAVER	(page 79)
OSD LANGUAGE	(page 79)
CONNECTION	(page 80)
MONITOR TYPE	(page 80)
HDMI CONNECTION	(page 80)
VIDEO PRIORITY MODE	(page 80)
HDMI OUTPUT RESOLUTION	(page 80)
BD-VIDEO 24p OUT	(page 80)
x.v.Color	(page 81)
Deep Color	(page 81)
HDMI RGB OUTPUT RANGE	(page 81)
HDMI --> DVI COLOR	(page 81)
HDMI AUDIO OUTPUT	(page 81)
HDMI-CEC	(page 81)
COMPONENT OUTPUT	(page 81)
VIDEO INPUT SETTING	(page 81)

Memo:

- The highlighted value is the default setting.

Setup

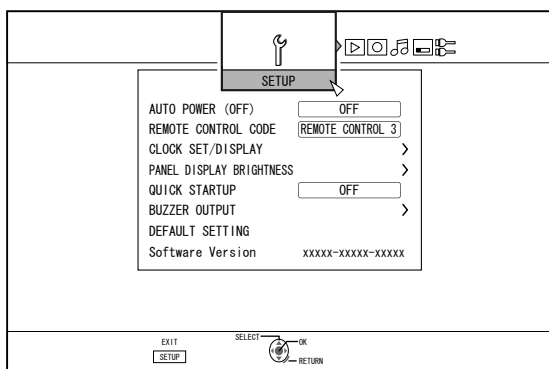

■ AUTO POWER (OFF)

You can specify a time for the power of the unit to turn off automatically when it is not being operated.

Setting Values	Description
OFF	Power does not turn off automatically.
2 HOURS	Turns off power after two hours.
6 HOURS	Turns off power after six hours.

■ REMOTE CONTROL CODE

For remote control units compliant with JVC's products, different remote control codes can be specified for those that are used with this unit.

Setting Values	Description
REMOTE CONTROL 1	Sets remote control code to 1.
REMOTE CONTROL 2	Sets remote control code to 2.
REMOTE CONTROL 3	Sets remote control code to 3.
REMOTE CONTROL 4	Sets remote control code to 4.

■ CLOCK SET/DISPLAY

The current date/time and the display format on the screen can be specified using the "CLOCK SET", "DATE DISPLAY", and "TIME DISPLAY CHOICE" items.

- **CLOCK SET**

Sets the current date and time.

Memo:

- For details on the setting procedures, refer to "Setting the date/time" (page 20).

- **DATE DISPLAY**

For setting the date (year, month, and day) display format.

Setting Values	Description
YEAR.MONTH.DAY	Displays the date in the year/month/day order.
MONTH.DAY.YEAR	Displays the date in the month/day/year order.
DAY.MONTH.YEAR	Displays the date in the day/month/year order.

- **TIME DISPLAY CHOICE**

For setting the time display format.

Setting Values	Description
12H	Displays the time in AM/PM format.
24H	Displays the time in 24-hour format.

■ PANEL DISPLAY BRIGHTNESS

The brightness of the display window can be specified using the "DIMMER (POWER ON)", and "DIMMER (POWER OFF)" control items.

- **DIMMER (POWER ON)**

For setting the brightness of the display window when the power is turned "On".

Setting Values	Description
BRIGHT	Bright
DIMMED1	Slightly dim
DIMMED2	Dim
DIMMED3	Dimmer
OFF	Off

Settings Menu

- DIMMER (POWER OFF)

For turning on/off the light of the display window when the power is turned "Off".

Setting Values	Description
OFF	Turns off the light.
ON	Turns on the light.

■ QUICK STARTUP

The quick startup setting can be specified as follows.

Setting Values	Description
OFF	Starts up in the normal way.
ON	Operation is speedily enabled after turning on the power. (Quick start)

Memo:

- Setting to "ON" increases power consumption while the unit is in the standby mode.

■ BUZZER OUTPUT

The buzzer setting can be specified as follows.

- REMOTE CONTROL SENSOR TONE

For setting whether to sound the buzzer when the remote control sensor receives signals.

Setting Values	Description
OFF	Buzzer does not sound when the remote control sensor receives signals.
ON	Sounds the buzzer when the remote control sensor receives signals.

- ALERT/WARNING TONE

For setting whether to sound the buzzer when an operation is completed or when a warning message appears.

Setting Values	Description
OFF	Buzzer does not sound.
ON	Sounds the buzzer.

■ DEFAULT SETTING

Restores the setting values on the setting screen to their factory default values.

Setting Values	Description
YES	Restores the factory default values.
NO	Returns to the initial screen without resetting the values.

Memo:

- "BD-VIDEO RATINGS" and "COUNTRY CODE" settings cannot be reset once they have been specified.

Playback Setting

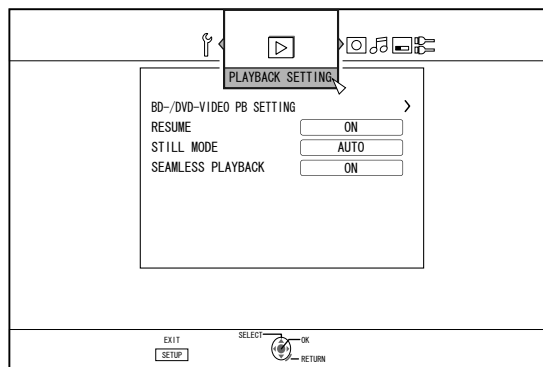

■ BD-/DVD-VIDEO PB SETTING

BD-Video and DVD-Video playback settings can be specified using the "BD-VIDEO RATINGS", "COUNTRY CODE", "AUDIO LANGUAGE", "SUBTITLE LANGUAGE", and "MENU LANGUAGE" items.

- BD-VIDEO RATINGS

For setting the lower age limit for BD-Video ratings.

Setting Values	Description
NO LIMIT	All BD-Videos can be viewed.
254YEAR(S)-0YEAR(S)	BD-Videos that are subject to the age limit cannot be viewed.

Memo:

- In order to set the restrictions, password (four-digit number) registration is required.
- The password status becomes unregistered if the restriction setting is disabled. A new password can be registered after setting the age limit again.
- It is recommended that you note down the password in case it is lost or forgotten.

- COUNTRY CODE

For setting the country code.

For details on the country codes, refer to the "Country Code List" (page 96).

Memo:

- If the "BD-VIDEO RATINGS" setting is specified, you will be required to enter the password registered for the "BD-VIDEO RATINGS" in order to change the "COUNTRY CODE".

- AUDIO LANGUAGE

For setting the audio sound when playing back BD-Videos or DVD-Videos.

For details on the language codes, refer to the "Language Code List" (page 94).

- SUBTITLE LANGUAGE

For setting the subtitle language when playing back BD-Videos or DVD-Videos.

For details on the language codes, refer to the "Language Code List" (page 94).

- MENU LANGUAGE

For setting the menu language when playing back BD-Videos or DVD-Videos.

For details on the language codes, refer to the "Language Code List" (page 94).

■ RESUME

The stop position can be stored when playback of a BD-Video, DVD-Video, BDMV, AVCHD, finalized discs, or SD card is stopped halfway.

Setting Values	Description
OFF	Resume information is not stored.
ON	Stores resume information.

Memo:

- Resume information is stored at all times for other discs as well as the HDD regardless of this setting.
- When a HDD title is selected using Playback Navigation, it is played back from the beginning.
- Some discs do not allow playback from the resume point.

■ STILL MODE

For setting the method for displaying paused images during playback of the HDD or a disc.

Setting Values	Description
AUTO	Automatic control.
FIELD	Use this setting for moving images or when there is blurring in the "AUTO" mode.
FRAME	Use this setting when detailed patterns or designs are not clear in the "AUTO" mode.

Memo:

- This setting is disabled for programs in the DR mode and during playback of AVCHD videos.

■ SEAMLESS PLAYBACK

For setting the method for playing back partially erased scenes.

Setting Values	Description
OFF	Plays back with high accuracy.
ON	Plays back smoothly.

Memo:

- SD picture quality is retained during re-encode dubbing.
- For joints of scenes that are 15 seconds or shorter, seamless playback may fail even when it is set to "ON". The same applies during re-encode dubbing in the SD picture quality.

Record

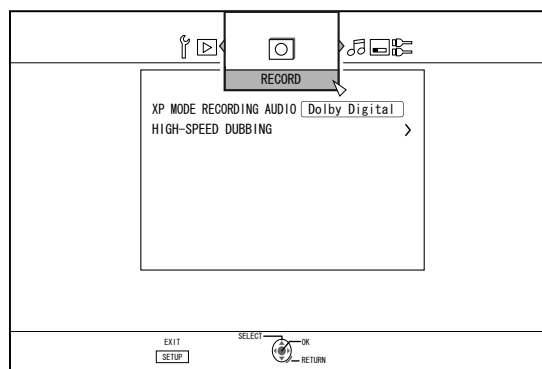

■ XP MODE RECORDING AUDIO

For changing the settings of audio mode during recording in the XP mode.

Setting Values	Description
Dolby Digital	Records in "Dolby Digital".
LPCM	Records in "LPCM".

■ HIGH-SPEED DUBBING

Items under "VIDEO MODE RECORDING ASPECT" and "DISC RECORDING AUDIO" can be set to support high-speed dubbing.

- VIDEO MODE RECORDING ASPECT

For setting the aspect ratio during recording.

Setting Values	Description
AUTO	Performs recording in the aspect ratio setting when recording starts.
4:3	Records at the fixed aspect ratio of 4:3.
16:9	Records at the fixed aspect ratio of 16:9.

Memo:

- High-speed dubbing to a DVD-Video disc cannot be performed when there are different aspect ratios in a title. In this case, fix the aspect ratio to 4:3 or 16:9. This setting remains valid during re-encode dubbing.

For details on high-speed dubbing and re-encode dubbing, refer to the "Dubbing chart" (page 24).

Settings Menu

• DISC RECORDING AUDIO

For changing the settings of audio to be recorded to the disc when in the AF, AN, AE or AL mode.

Setting Values	Description
AUTO	Records "Stereo", "Surround" or "Dual broadcast" audio sounds as they are.
FIXED	Records "Stereo" and "Surround" sounds in "Stereo". "Dual broadcast" audio sounds are recorded as they are.

Memo:

- Surround sounds of a title become stereo sounds when re-encode dubbing is performed.

Audio

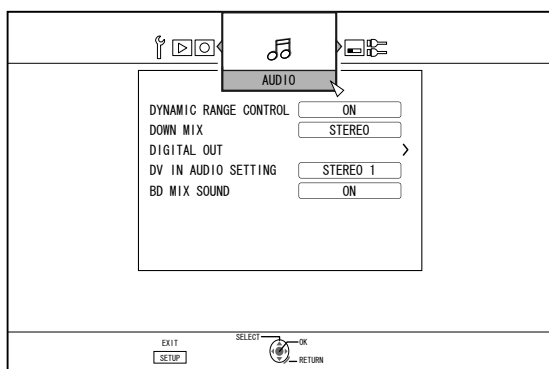

■ DYNAMIC RANGE CONTROL

For setting the dynamic range compression ratio (ratio between the maximum and minimum volume) during Dolby Digital playback.

Setting Values	Description
AUTO	Perform compression only for Dolby TrueHD.
OFF	Not compressed.
ON	Perform maximum compression.

Memo:

- Setting to "OFF" may produce the same effects as the "ON" mode for some discs.
- Performing compression allows even the slightest sound to be heard clearly.
- There may be differences in the effect depending on the disc used.

■ DOWN MIX

For setting whether to output analog audio.

Setting Values	Description
STEREO	Use this setting when connecting an audio amplifier or TV.
DOLBY SURROUND	Use this setting when connecting an amplifier that supports Dolby Surround.

■ DIGITAL OUT

Set this item according to the device connected to the digital audio output terminal (optical digital).

• PCM DOWN SAMPLING

For specifying settings on sampling frequency conversion.

Setting Values	Description
OFF	Sampling frequency is not converted.
ON	Audio recorded at a sampling frequency of 96 kHz or 88.2 kHz is converted to 48 kHz and 44.1 kHz respectively.

Memo:

- Setting to "OFF" may produce the same effects as the "ON" mode for some discs.
- Dolby Digital

For setting audio output to "BITSTREAM" or "PCM".

Setting Values	Description
BITSTREAM	Use this setting when connecting a device that is able to decode "Dolby Digital".
PCM	Audio input will be changed and output as "PCM". Use this setting when connecting a device that is unable to decode "Dolby Digital".

• Dolby Digital Plus/TrueHD

For setting audio output to "BITSTREAM" or "PCM".

Setting Values	Description
BITSTREAM	Use this setting when connecting a device that is able to decode "Dolby Digital Plus/TrueHD".
PCM	Audio input will be changed and output as "PCM". Use this setting when connecting a device that is unable to decode "Dolby Digital Plus/TrueHD".

• DTS

For setting audio output to "BITSTREAM" or "PCM".

Setting Values	Description
BITSTREAM	Use this setting when connecting a device that is able to decode "DTS".
PCM	Audio input will be changed and output as "PCM". Use this setting when connecting a device that is unable to decode "DTS".

• DTS-HD

For setting audio output to "BITSTREAM" or "PCM".

Setting Values	Description
BITSTREAM	Use this setting when connecting a device that is able to decode "DTS-HD".
PCM	Audio input will be changed and output as "PCM". Use this setting when connecting a device that is unable to decode "DTS-HD".

• AAC

For setting audio output to "BITSTREAM" or "PCM".

Setting Values	Description
BITSTREAM	Use this setting when connecting a device that is able to decode "AAC".
PCM	Audio input will be changed and output as "PCM". Use this setting when connecting a device that is unable to decode "AAC".

Memo:

- Audio sound may not be properly played back if the audio equipment in use does not support "BITSTREAM" output. In this case, set to "PCM".

■ DV IN AUDIO SETTING

For changing the audio recording settings during DV input.

Setting Values	Description
STEREO 1	Records the audio sound during video recording (L1, R1).
STEREO 2	Records audio sound that is added later (L2, R2), such as during editing.
MIX	Records "STEREO 1" and "STEREO 2" sounds.

■ BD MIX SOUND

For setting a mixture of BD video secondary audio and operation sounds output.

Setting Values	Description
OFF	Outputs main audio only.
ON	Outputs a mixture of BD video secondary audio and operation sounds during playback of BD-Videos that contain BD video secondary audio and menu operation sounds.

Memo:

- Output is converted to Dolby Digital or DTS according to the main audio when the "DIGITAL OUT" item is set to "BITSTREAM".

Display

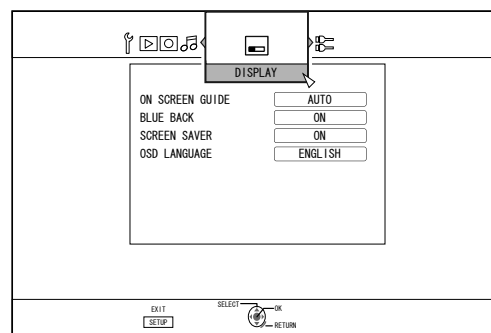

■ ON SCREEN GUIDE

For displaying operation details.

Setting Values	Description
AUTO	Appears for five seconds when an operation is performed.
OFF	Not displayed.

■ BLUE BACK

For setting the screen display when there is no signal input.

Setting Values	Description
OFF	Displays screen as it is.
ON	Switches display to a blue screen.

■ SCREEN SAVER

For setting whether to use a screensaver.

Setting Values	Description
OFF	Screen saver is not used.
ON	Screen saver is used. Switches to the burn-in prevention screen when the unit is not operated for more than five minutes.

■ OSD LANGUAGE

For setting the language for messages displayed on-screen.

Settings Menu

Connection

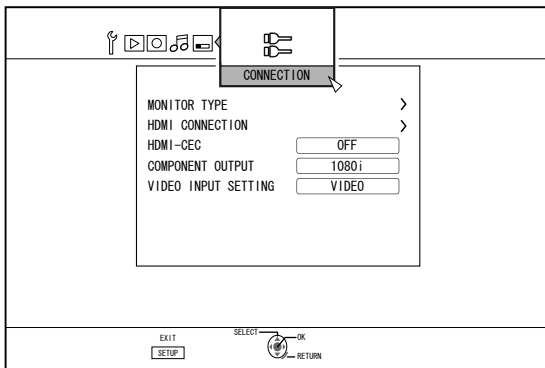

MONITOR TYPE

For setting the aspect ratio according to the connected monitor.

Setting Values	Description
16:9	Set to this value when connected to monitors with 16:9 aspect ratio.
16:9FULL	Choose this setting when a 16:9 monitor is connected to display images without the black borders.
4:3 PAN&SCAN	Set to this value when connecting to monitors with an aspect ratio of 4:3. Plays back videos with the left and right edges trimmed off.
4:3 LETTERBOX	Set to this value when connecting to monitors with an aspect ratio of 4:3. Plays back videos with a black band at the upper and lower ends.

HDMI CONNECTION

VIDEO PRIORITY MODE

Setting Values	Description
COMPONENT	Set to this value for output at a resolution of "480p" or higher from the [COMPONENT VIDEO OUT] terminal.
HDMI	Set to this value when priority is to be given to the "HDMI OUTPUT RESOLUTION" setting.

Memo:

- During data output from the [HDMI] terminal, setting to "COMPONENT" automatically outputs data in the "COMPONENT OUTPUT" setting. Setting to "HDMI" outputs data in the "HDMI OUTPUT RESOLUTION" setting.
- During data output from the [HDMI] and [COMPONENT VIDEO OUT] terminals, setting to "COMPONENT" automatically outputs data in the "COMPONENT OUTPUT" setting. Setting to "HDMI" outputs data at the "480i" resolution from the [COMPONENT VIDEO OUT] terminal.
- When there is no output from the [HDMI] terminal, data is automatically output in the "COMPONENT OUTPUT" setting from the [COMPONENT VIDEO OUT] terminal.

HDMI OUTPUT RESOLUTION

Setting Values	Description
AUTO	Automatically selects an appropriate resolution according to the connected device.
480p	Fixes the resolution at 480p.
1080i	Fixes the resolution at 1080i.
720p	Fixes the resolution at 720p.
1080p	Fixes the resolution at 1080p.

Memo:

- When the resolution is set to "720p", videos are output at "1080i" other than those recorded at "720p" even though "720p" is shown on the display.
- Depending on the conditions (monitor type 16:9, resolution "720p" and above, aspect 4:3), some of the OSD display of the component output may be cut off. In this case, set "VIDEO PRIORITY MODE" to "COMPONENT". OSD of the [VIDEO OUT]/[S-VIDEO OUT] terminals may be cut off with the above conditions even when "COMPONENT" is selected. In this case, set the component resolution to "480p" or below, or set the monitor type to other settings except 16:9.

BD-VIDEO 24p OUT

Setting Values	Description
OFF	Outputs in the resolution set by "HDMI OUTPUT RESOLUTION".
ON	Outputs 24p elements at 24p.

Memo:

- 24p playback is possible for commercially available BD-Videos or BDMVs that are recorded in 24p. Content other than BDMVs that is dubbed or recorded on this unit at 24p, as well as 24p content on SD cards are played back at 60p or 60i.
- This is applicable for BD-ROM and DVD-Video titles. This is available when connected to a 24p compatible monitor.
- Elements other than 24p ones are output at 60p.
- No video images will be output from the video, S-video and component outputs when the HDMI output resolution is at 1080/24p.

- x.v.Color

Setting Values	Description
AUTO	Outputs x.v.Color information with HDMI when video images that include x.v.Color information are played back.
OFF	This is applicable when an x.v.Color compatible monitor is connected.

Memo:

- This is applicable when an x.v.Color compatible monitor is connected.

- Deep Color

Setting Values	Description
AUTO	Set to this value when a "Deep Color" device is connected.
OFF	Set to this value when the video image is distorted, or colors are unnatural.

- HDMI RGB OUTPUT RANGE

Setting Values	Description
STANDARD	Set to this value for standard uses.
ENHANCED	Set to this value when the black and white parts of the video image are not distinct.

Memo:

- This is available when connected to a DVI device that only supports RGB input.

- HDMI --> DVI COLOR

Setting Values	Description
AUTO	Value is set automatically according to the monitor.
RGB FIX	Use this setting when video images are not correctly displayed on the monitor.

Memo:

- This is available when the "x.v.Color" setting is set to "OFF". When the "x.v.Color" setting is set to "AUTO", this setting will be set to "AUTO" automatically.
- Change this setting when no video image appears while connected to a DVI device.

- HDMI AUDIO OUTPUT

Setting Values	Description
OFF	Use this setting if you do not want to send audio output from the HDMI cable.
ON	Use this setting to send audio output from the HDMI cable.

■ HDMI-CEC

For setting the HDMI-CEC operation from the connected device.

Setting Values	Description
OFF	Disables HDMI-CEC.
ON	Enables HDMI-CEC.

■ COMPONENT OUTPUT

For setting the resolution of video output from the [COMPONENT VIDEO OUT] terminals.

Setting Values	Description
480i	Sets output to "480i".
480p	Sets output to "480p".
720p	Sets output to "720p".
1080i	Sets output to "1080i".

Memo:

- When the resolution is set to "720p", videos are output at "1080i" other than those recorded at "720p" even though "720p" is shown on the display.
- This unit does not support component output at "1080p". To output at "1080p", do so via HDMI connection.
- If "VIDEO PRIORITY MODE" is set to "HDMI", the unit will output at "480i" regardless of the current setting.
- If "VIDEO PRIORITY MODE" is set to "COMPONENT", or when a HDMI connection is used, DVD videos will be output at "480p" even if "720p" or "1080i" has been set.
- The aspect ratio of video/S-video output changes according to the component output setting. As such, there may be cases where the aspect ratio of the video/S-video output is different from the predefined setting of the content.

■ VIDEO INPUT SETTING

Choose a setting according to the video terminal to be connected when an external analog input terminal is used.

Setting Values	Description
VIDEO	Use this setting when connecting via the video (BNC) terminal.
S-VIDEO	Use this setting when connecting via the S-video (black) terminal.

Locking the Disc Tray

By turning on the lock for the disc tray, the tray cannot be opened or closed using the [▲] button.

Memo:

- When the [▲] button is pressed while the disc tray lock is turned on, a "LOCKED" message will appear on the display window of the unit for about three seconds.

Locking the disc tray

- 1 Press the [⏻/⏻] button on the unit to turn "Off" the power
 - 2 Press and hold the [■] button on this unit, then press the [▲] button
- A "LOCKED" message appears on the display window of the unit, indicating that the disc tray is locked.

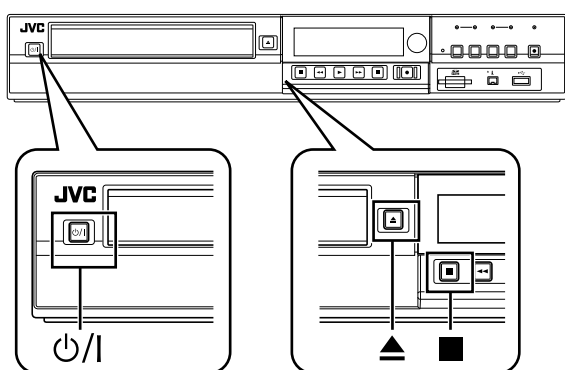

Unlocking the disc tray

- 1 Press the [⏻/⏻] button on the unit to turn "Off" the power
 - 2 Press and hold the [■] button on this unit, then press the [▲] button
- An "UNLOCK" message appears on the display window of the unit, indicating that the disc tray is unlocked.

Turning on the Mode Lock

Turning on the mode lock disables all operations using the buttons on the unit and remote control, except for "Play" and "Record".

Memo:

- When a button that is disabled is pressed, a "LOCKED" message will appear on the display window of the unit for three seconds.

Turning on the mode lock

- 1 Press the [*] button on the remote control for five seconds or longer when in the "Normal Recording", "Stop", or "Normal Playback" mode
- A "LOCKED" message appears on the display window of the unit, indicating that the mode lock is turned on.

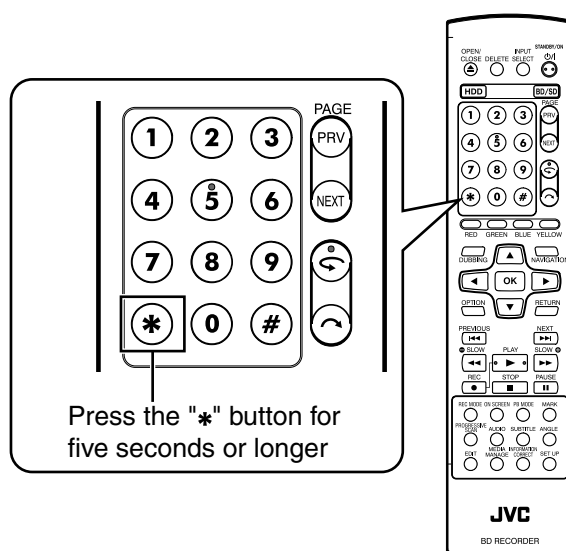

Turning off the mode lock

- 1 Press the [*] button on the remote control for five seconds or longer when the mode lock is turned on
- An "UNLOCK" message appears on the display window of the unit, indicating that the mode lock is turned off.

Last Function Memory

When the power plug is disconnected from unit or when power failure occurs, your settings for the following functions are kept in the memory. These settings will resume when the unit is turned on again.

- Various setting menus (☞ Page 74 - 81)
- Deck selection: HDD/BD/SD
- Recording mode: XP, etc. (☞ page 28)
- Input selection: L-1/DV (☞ page 47)
- Repeat playback of the disc playback settings menu (☞ page 56)
Kept for DVD-Video/AVCHD/BDMV and title/chapter only.

RS-232C Interface (only for SR-HD1500)

Command Table only for SR-HD1500

Lower Order → Higher Order ↓	0	1	2	3	4	5	6	7	8	9	A	B	C	D	E	F
0		Complete	Error	Cassette Out		Not Target					ACK	NAK				
1																
2																
3											Play					Stop
4																Still
5							Clear									
6	Sense Chapter	Title Sense														
7																
8	Chapter Search	Title Search													Date Preset	Clock Preset
9	Finalize	Cancel-Disc Finalization	Disc Erase	TOP MENU	MENU	NEXT CHAPTER	PREV CHAPTER	Setup	SET	UP	DOWN	RIGHT	LEFT	Next Title	Prev Title	Remote Data
A	Standby On	Standby Off		Eject								FF	REW	Fwd Field Step	Rev Field Step	
B						Fwd Shtl	Rev Shtl		Select Preset	Select Sense					Date Data Sense	Clock Data Sense
C											Rec					
D								Status Sense	Tc Data Sense	CTL Data Sense				JVC Status Sense		
E																
F	Command Target										Rec/Dub Request					

Specifications

- Pin layout

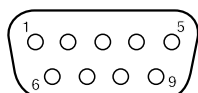

PIN No.	Signal	Operation	Direction of signal
2	TxD	Transmit data	This unit ⇒ PC
3	RxD	Receive data	This unit ⇐ PC
5	GND	Signal grounding	

- Mode : Non-synchronous
- Character length : 8 bits
- Parity check : Odd
- Start bit : 1
- Stop bit : 1
- Data rate : 9600 bps

- Bit configuration

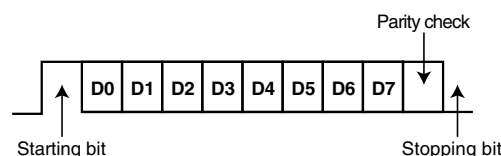

Memo:

- When using the Serial Command Connector, the cable to be used should be a RS-232C interface cable (straight type, 3 m or shorter).
- When using RS-232C, set "QUICK STARTUP" in the settings menu to "ON".
- During command transmission, a minimum interval of About 50 milliseconds is required between each command.
- During command transmission, do not send the next command until the ACK (refer to "System Commands" (page 90)) or response (refer to "Response Commands" (page 90)) for each command is received.
- The recommended maximum waiting time for the ACK or response for each command is as follows.

ACK : About 50 milliseconds

Response : About 5 seconds

Command

■ Operation Commands

Commands for operating functions such as PLAY and REC on the BLU-RAY DISC & HDD RECORDER

Command	Description
3A	Plays the selected deck.
3F	Stops the selected deck. Resume will be cleared when this is pressed while in the Stop mode. Rec Request will be cleared.
4F	Switches the selected deck to the Still mode.
56	Clear: Clears the Error status.
80	Searches the specified chapter and starts playback from the beginning.
81	Searches the specified title under "ORIGINAL" or in the "PLAY LIST" by its number and starts playback from the beginning.
8E	For setting the date.
8F	For setting the time.
90	Finalizes the disc. (BD Deck)
91	Cancel disc finalization. (BD Deck)
92	For erasing rewritable discs.
93	Displays/Closes the top menu of a disc. (BD Deck)
94	Displays/Closes the disc menu. (BD Deck)
95	Advances to the next chapter. Functions like the ►► button on the remote control.
96	Returns to the previous chapter. Functions like the ◀◀ button on the remote control.
97	Displays/Closes the Main Menu, Editing, Library Database Navigation or Dubbing screen. 97 ⇨ 30: Closes the screen. 97 ⇨ 31: Displays the Main Menu screen. 97 ⇨ 32: Displays the Library Database Navigation screen. 97 ⇨ 35: Displays the Editing screen. 97 ⇨ 37: Displays the Dubbing screen.
98	Functions as a confirmation key.
99	Functions as an up key.
9A	Functions as a down key.
9B	Functions as a right key.
9C	Functions as a left key.
9D	Advances to the next title. Functions like the ►► button on the remote control.
9E	Returns to the previous title. Functions like the ◀◀ button on the remote control.
9F	Issues the same codes as the wired remote control via RS-232C.
A0	Power On

A1	Power Off
A3	Eject: Opens/Closes tray. (BD Deck only)
AB	FF: Functions only during playback. Activates forward search.
AC	REW: Functions only during playback. Activates reverse search.
AD	Functions as a key for advancing (FWD) a frame. When this command is received during still mode, the unit advances the still picture by one frame (or field) in the FWD direction.
AE	Functions as a key for reversing (REV) a frame. When this command is received during still mode, the unit reverses the still picture by one frame (or field) in the REV direction.
B5	Fwd Shtl: Functions only during playback. Activates forward search. B5 ⇨ 30: STILL B5 ⇨ 31: FWD SLOW at a slow speed. B5 ⇨ 33: FWD SLOW at a fast speed. B5 ⇨ 35: 1x B5 ⇨ 36: FWD SEARCH at a fast speed. B5 ⇨ 37: FWD SEARCH at a faster speed. B5 ⇨ 38: FWD SEARCH at the fastest speed.
B6	Rev Shtl: Functions only during playback. Activates reverse search. B6 ⇨ 30: STILL B6 ⇨ 31: REV SLOW at a slow speed. B6 ⇨ 33: REV SLOW at a fast speed. B6 ⇨ 36: REV SEARCH at a fast speed. B6 ⇨ 37: REV SEARCH at a faster speed. B6 ⇨ 38: REV SEARCH at the fastest speed.
B8	For setting the input/output, recording mode, audio language selection and subtitle selection.
CA	Rec: Starts recording at the selected deck when a Rec Request is received.
F0	Command Target: F0 ⇨ 34: For selecting HDD deck. F0 ⇨ 38: For selecting BD deck. F0 ⇨ 3C: For selecting SD deck.
FA	Rec Request: For issuing approval for recording. This can be cleared using STOP.

80-8F

80 : Chapter Search

	1st Byte	2nd Byte	3rd Byte
Chapter Search	Hundreds	Tens	Ones
ASCII codes (30 - 39)	3*	3*	3*
E.g. (012)	30	31	32

E.g. : When searching the 12th chapter.

81 : Title Search under "ORIGINAL"

	1st Byte	2nd Byte	3rd Byte	4th Byte
Title Search (ORIGINAL)	30	Hundreds	Tens	Ones
ASCII codes (30 - 39)	30	3*	3*	3*
E.g. (345)	30	33	34	35

E.g. : When searching the 345th title, as indicated by the title number on the top right corner of the index, under "ORIGINAL".

81 : Title Search in "PLAY LIST"

	1st Byte	2nd Byte	3rd Byte	4th Byte
Title Search (PLAY LIST)	38	Hundreds	Tens	Ones
ASCII codes (30 - 39)	38	3*	3*	3*
E.g. (028)	38	30	32	38

E.g. : When searching the 28th play list, as indicated by the play list number on the top right corner of the index, in the "PLAY LIST".

8E : Date Preset

	1st Byte	2nd Byte	3rd Byte	4th Byte	5th Byte	6th Byte
Date Preset	Mth (Tens)	Mth (Ones)	Day (Tens)	Day (Ones)	Yr (Tens)	Yr (Ones)
ASCII code (30 - 39)	3*	3*	3*	3*	3*	3*
E.g. (09.14.2009)	30	39	31	34	30	39

E.g. : When setting the date to September 14 2009.

8F : Clock Preset

	1st Byte	2nd Byte	3rd Byte	4th Byte	5th Byte	6th Byte
Clock Preset	Hr (Tens)	Hr (Ones)	Min (Tens)	Min (Ones)	Sec (Tens)	Sec (Ones)
ASCII code (30 - 39)	3*	3*	3*	3*	3*	3*
E.g. (12:34:56)	31	32	33	34	35	36

E.g. : When setting the time to 12 hrs 34 min and 56 sec.

Others

9F

9F : Remote Data

The remote control codes for controlling the wired remote controller via RS-232C is as shown in the following table. The codes apply to all three HDD, BD and SD deck unless otherwise stated.

Code	Items	Remarks
01	INPUT SELECT	
03	STOP	
06	F.F/SPEED+	
07	REW/SPEED-	
0B	POWER ON/OFF	
0C	PLAY	
0D	PAUSE/STILL	
14	FWD SKIP	
15	REV SKIP	
17	AUDIO	
1A	Power Off	
1D	Power On	Use with "QUICK STARTUP" set to "ON". Refer to "QUICK STARTUP" (page 76) .
21	TEN KEY 1	
22	TEN KEY 2	
23	TEN KEY 3	
24	TEN KEY 4	
25	TEN KEY 5	
26	TEN KEY 6	
27	TEN KEY 7	
28	TEN KEY 8	
29	TEN KEY 9	
2A	KEY *	
2B	TEN KEY 0	
2C	KEY #	
31	REC MODE (XP/SP/LP/EP...)	
32	BD/DVD DECK	
34	DUBBING	
37	SET UP	
3C	OK/ENTER	
3E	ON SCREEN	
44	HDD DECK	
48	MEDIA MANAGEMENT	
80	CUSOR 0°	Moves the arrow in the index list to the right. (▶)
81	MENU	BD/DVD Deck only
82	CUSOR 90°	Moves the arrow in the index list to the up. (▲)
84	CUSOR 180°	Moves the arrow in the index list to the left. (◀)
86	CUSOR 270°	Moves the arrow in the index list to the down. (▼)
87	OPEN/CLOSE	BD/DVD Deck only
8E	PROGRESSIVE	HDD/BD Deck only
8F	TOP MENU	DVD Deck only
90	MARK	HDD/DVD Deck only
96	CM SKIP	
AF	REV FRAME	
B0	-SLOW D	
B1	SHUTTLE-C	
B2	SHUTTLE-B	
B3	SHUTTLE-A	
B4	SHUTTLE-2	
B5	SHUTTLE-1	
B6	-SLOW B	
B7	-SLOW C	
B8	+SLOW C	
B9	+SLOW B	
BA	SHUTTLE +1	
BB	SHUTTLE +2	
BC	SHUTTLE +A	
BD	SHUTTLE +B	
BE	SHUTTLE +C	
BF	+SLOW D	
C0	ANGLE/LIVE CHECK	ANGLE (BD/DVD Deck only) LIVE CHECK (HDD/BD Deck only)
C4	SUBTITLE DVD Deck only	
CC	REC	
D4	RETURN	
D5	COLOR KEY BLUE	
D7	COLOR KEY RED	
D9	JOG-1/6	

DA	JOG +1/6	
DB	JOG +1	
DC	INSTANT REPLAY	
DD	EDIT	
DE	COLOR KEY GREEN	
DF	COLOR KEY YELLOW	
E0	NAVIGATION	
E1	L1 Y/C INPUT SELECT	HDD Deck only

E2	L1 COMPOSITE INPUT SELECT	HDD Deck only
E3	PLAYBACK SETTING	
E4	DELETE	
E5	INFORMATION CORRECT	
ED	FWD FRAME	
F2	MODE LOCK	

B8

B8 : Input/Output Selection

		1st Byte	2nd Byte
External input selection	L-1 VIDEO	30	31
External input selection	L-1 S-VIDEO	30	39
External input selection	DV	30	34

B8 : Recording Mode Selection

	1st Byte	2nd Byte
XP	34	30
SP	34	31
LP	34	32
EP	34	33
DR	34	3A
AF	34	3B
AN	34	3C
AL	34	3D
AE	34	3E

Others

Subtitle Selection

B8 : Subtitle Selection

	1st Byte	2nd Byte		1st Byte	2nd Byte		1st Byte	2nd Byte		1st Byte	2nd Byte
OFF	3C	10	EL	3C	31	LO	3C	56	SL	3C	78
JAPANESE	3C	11	EO	3C	32	LT	3C	57	SM	3C	79
ENGLISH	3C	12	ET	3C	33	LV	3C	58	SN	3C	7A
GERMAN	3C	13	EU	3C	34	MG	3C	59	SO	3C	7B
FRENCH	3C	14	FA	3C	35	MI	3C	5A	SQ	3C	7C
ITALIAN	3C	15	FJ	3C	36	MK	3C	5B	SR	3C	7D
SPANISH	3C	16	FO	3C	37	ML	3C	5C	SS	3C	7E
DUTCH	3C	17	FY	3C	38	MN	3C	5D	ST	3C	7F
SWEDISH	3C	18	GA	3C	39	MO	3C	5E	SU	3C	80
NORWEGIAN	3C	19	GD	3C	3A	MR	3C	5F	SW	3C	81
FINNISH	3C	1A	GL	3C	3B	MS	3C	60	TA	3C	82
DANISH	3C	1B	GN	3C	3C	MT	3C	61	TE	3C	83
AA	3C	1C	GU	3C	3D	MY	3C	62	TG	3C	84
AB	3C	1D	HA	3C	3E	NA	3C	63	TH	3C	85
AF	3C	1E	HI	3C	3F	NE	3C	64	TI	3C	86
AM	3C	1F	HR	3C	40	OC	3C	65	TK	3C	87
AR	3C	20	HU	3C	41	OM	3C	66	TL	3C	88
AS	3C	21	HY	3C	42	OR	3C	67	TN	3C	89
AY	3C	22	IA	3C	43	PA	3C	68	TO	3C	8A
AZ	3C	23	IE	3C	44	PL	3C	69	TR	3C	8B
BA	3C	24	IK	3C	45	PS	3C	6A	TS	3C	8C
BE	3C	25	IS	3C	47	PT	3C	6B	TT	3C	8D
BG	3C	26	KA	3C	4B	QU	3C	6C	TW	3C	8E
BH	3C	27	KK	3C	4C	RM	3C	6D	UK	3C	8F
BI	3C	28	KL	3C	4D	RN	3C	6E	UR	3C	90
BN	3C	29	KM	3C	4E	RO	3C	6F	UZ	3C	91
BO	3C	2A	KN	3C	4F	RU	3C	70	VI	3C	92
BR	3C	2B	KO	3C	50	RW	3C	71	VO	3C	93
CA	3C	2C	KS	3C	51	SA	3C	72	WO	3C	94
CO	3C	2D	KU	3C	52	SD	3C	73	XH	3C	95
CS	3C	2E	KY	3C	53	SG	3C	74	YO	3C	96
CY	3C	2F	LA	3C	54	SI	3C	76	ZH	3C	97
DZ	3C	30	LN	3C	55	SK	3C	77	ZU	3C	98

"Language Code List" (☞ page 94)

Audio Language Selection

B8 : Audio Language Selection

	1st Byte	2nd Byte		1st Byte	2nd Byte		1st Byte	2nd Byte		1st Byte	2nd Byte
JAPANESE	39	11	EO	39	32	LT	39	57	SM	39	79
ENGLISH	39	12	ET	39	33	LV	39	58	SN	39	7A
GERMAN	39	13	EU	39	34	MG	39	59	SO	39	7B
FRENCH	39	14	FA	39	35	MI	39	5A	SQ	39	7C
ITALIAN	39	15	FJ	39	36	MK	39	5B	SR	39	7D
SPANISH	39	16	FO	39	37	ML	39	5C	SS	39	7E
DUTCH	39	17	FY	39	38	MN	39	5D	ST	39	7F
SWEDISH	39	18	GA	39	39	MO	39	5E	SU	39	80
NORWEGIAN	39	19	GD	39	3A	MR	39	5F	SW	39	81
FINNISH	39	1A	GL	39	3B	MS	39	60	TA	39	82
DANISH	39	1B	GN	39	3C	MT	39	61	TE	39	83
AA	39	1C	GU	39	3D	MY	39	62	TG	39	84
AB	39	1D	HA	39	3E	NA	39	63	TH	39	85
AF	39	1E	HI	39	3F	NE	39	64	TI	39	86
AM	39	1F	HR	39	40	OC	39	65	TK	39	87
AR	39	20	HU	39	41	OM	39	66	TL	39	88
AS	39	21	HY	39	42	OR	39	67	TN	39	89
AY	39	22	IA	39	43	PA	39	68	TO	39	8A
AZ	39	23	IE	39	44	PL	39	69	TR	39	8B
BA	39	24	IK	39	45	PS	39	6A	TS	39	8C
BE	39	25	IS	39	47	PT	39	6B	TT	39	8D
BG	39	26	KA	39	4B	QU	39	6C	TW	39	8E
BH	39	27	KK	39	4C	RM	39	6D	UK	39	8F
BI	39	28	KL	39	4D	RN	39	6E	UR	39	90
BN	39	29	KM	39	4E	RO	39	6F	UZ	39	91
BO	39	2A	KN	39	4F	RU	39	70	VI	39	92
BR	39	2B	KO	39	50	RW	39	71	VO	39	93
CA	39	2C	KS	39	51	SA	39	72	WO	39	94
CO	39	2D	KU	39	52	SD	39	73	XH	39	95
CS	39	2E	KY	39	53	SG	39	74	YO	39	96
CY	39	2F	LA	39	54	SI	39	76	ZH	39	97
DZ	39	30	LN	39	55	SK	39	77	ZU	39	98
EL	39	31	LO	39	56	SL	39	78			

“Language Code List” (☞ page 94)

Others

Response Commands

Commands relating to RS-232C control system.

Command	Description
01	Complete: Issued by the external recorder upon completing all specified operations by commands.
02	Error: Issued by the external recorder when receiving invalid commands in the context. In such cases, commands that are sent will not be accepted. However, a return command will be issued but only to the Status Sense. To clear the Error status, perform command 56 (Clear).
05	Not Target: Issued by the external recorder when specified operations by commands cannot be completed properly.
0A	ACK: A return command issued when a defined command is received.
0B	NAK: A return command issued when an undefined or possibly nonexistent command is received.
03	Cassette Out: Issued upon completing the operation of opening and closing the tray when the HDD/DVD deck is selected.

System Commands

Commands for acquiring information such as deck status.

Command	Description
60	Chapter Sense: For acquiring the current chapter number. (*)
61	Title/Track Sense: For acquiring the current title number under "ORIGINAL" or in the "PLAY LIST". (*)
B9	Select Sense: For acquiring the status of the inputs, outputs, recording mode, audio language selection and subtitle selection. (*)
BE	Date Sense: For acquiring the currently configured year, month and day. (*)
BF	Time Sense: For acquiring the currently configured hour, minute and second. (*)
D7	Status Sense: For acquiring the deck information. (*)
D8	TC Data Sense: For acquiring the total remaining time in the current recording mode when there is a media in the selected deck. (*)
D9	CTL Data Sense: For acquiring the lapse counter when there is a media in the selected deck. (*)
DD	JVC Status Sense: Returns data from the unit. (*)
FB	VTR Ind: A command for checking whether the connected device is the external recorder.

(*) : See  pages 90-93 for data format.

Sense

- Chapter Sense

	1st Byte	2nd Byte	3rd Byte
Chapter Sense	Hundreds	Tens	Ones
60	3*	3*	3*
E.g. (012)	30	31	32

E.g. : When the current chapter is the 12th chapter.

- Title/Track Sense under "ORIGINAL"

	1st Byte	2nd Byte	3rd Byte	4th Byte
Title/Track Sense (ORIGINAL)	30	Hundreds	Tens	Ones
61	30	3*	3*	3*
E.g. (345)	30	33	34	35

E.g. : When the current title under "ORIGINAL" is the 345th title.

- Title/Track Sense in "PLAY LIST"

	1st Byte	2nd Byte	3rd Byte	4th Byte
Title/Track Sense (PLAY LIST)	38	Hundreds	Tens	Ones
61	38	3*	3*	3*
E.g. (028)	38	30	32	38

E.g. : When the current title under "PLAY LIST" is the 28th title.

- Select Sense

	1st Byte	2nd Byte	3rd Byte	4th Byte	5th Byte
Select Sense	External input selection	Output selection	Recording mode selection	Audio language selection	Subtitle selection
B9	3*	3*	**	**	**
E.g. (3930311213)	39	30	31	12	13

E.g. : When the selection status of the video deck is as follows:

External input selection ⇒ L-1 S-VIDEO

Output selection ⇒ Common output (Frame is fixed at 0.)

Recording mode selection ⇒ SP

Audio language selection ⇒ ENGLISH

Subtitle selection ⇒ GERMAN

For response data for B9, see data format for "B8 (Select Preset)" (page 87-89).

When the current status cannot be acquired, the value is fixed as "-" (0x2D).

- Date Data Sense

For acquiring the currently configured year, month and day in ASCII codes.

	1st Byte	2nd Byte	3rd Byte	4th Byte	5th Byte	6th Byte
Date Sense	Mth (Tens)	Mth (Ones)	Day (Tens)	Day (Ones)	Yr (Tens)	Yr (Ones)
BE	3*	3*	3*	3*	3*	3*
E.g. (09.14.2009)	30	39	31	34	30	39

When the current date is not set, the value is fixed as "-" (0x2D).

- Time Data Sense

For acquiring the currently configured hour, minute and second in ASCII codes.

	1st Byte	2nd Byte	3rd Byte	4th Byte	5th Byte	6th Byte
Time Sense	Hr (Tens)	Hr (Ones)	Min (Tens)	Min (Ones)	Sec (Tens)	Sec (Ones)
BF	3*	3*	3*	3*	3*	3*
E.g. (12:34:56)	31	32	33	34	35	36

When the current time is not set, the value is fixed as "-" (0x2D).

Others

- Status Data Sense

For acquiring the remaining time in the current recording mode in hours, minutes and seconds for HDD/DVD.

D7 STATUS SENSE	1byte	1byte	1byte	2byte	3byte	4byte	5byte
	HDD	BD	SD	HDD/BD/SD	HDD/BD/SD	HDD/BD/SD	HDD/BD/SD
bit7	1 (Fixed)	1 (Fixed)	1 (Fixed)	Video EE	0 (Fixed)	During PLAY	During PAUSE (Set to 1 simultaneously with "During PLAY" in STILL mode.)
bit6	0 (Fixed)	1 (Fixed)	1 (Fixed)	Audio EE	0 (Fixed)	0 (Fixed)	0 (Fixed)
bit5	0 (Fixed)	0 (Fixed)	1 (Fixed)	0 (Fixed)	0 (Fixed)	0 (Fixed)	During Reverse Shuttle Search (Excluding STILL)
bit4	Record Forbidden	Record Forbidden	1 (Fixed)	0 (Fixed)	0 (Fixed)	During STOP	During Forward Shuttle Search (Excluding STILL)
bit3	Disc Not Inserted	Disc Not Inserted	Disc Not Inserted	Occurrence of abnormality in VTR	0 (Fixed)	During STANDBY (Unit Power Off)	Refer to the SEARCH SPEED table.
bit2	0 (Fixed)	0 (Fixed)	0 (Fixed)	0 (Fixed)	During Repeat Playback (Including PAUSE)	0 (Fixed)	Refer to the SEARCH SPEED table.
bit1	0 (Fixed)	0 (Fixed)	0 (Fixed)	0 (Fixed)	0 (Fixed)	During REC	Refer to the SEARCH SPEED table.
bit0	RS-232C command error status. Clear using 56 (Clear).	RS-232C command error status. Clear using 56 (Clear).	RS-232C command error status. Clear using 56 (Clear).	0 (Fixed)	0 (Fixed)	0 (Fixed)	Refer to the SEARCH SPEED table.

- TC Data Sense

	1st Byte	2nd Byte	3rd Byte	4th Byte	5th Byte	6th Byte	7th Byte	8th Byte
TC Data Sense	Hr (Tens)	Hr (Ones)	Min (Tens)	Min (Ones)	Sec (Tens)	Sec (Ones)	Frame (Tens)	Frame (Ones)
D8	3*	3*	3*	3*	3*	3*	3*	3*
E.g. (01:23:45)	30	31	32	33	34	35	30	30

E.g. : When remaining time is 1 hr 23 min 45 sec.

Frame is fixed as 0.

• SEARCH SPEED

	bit3	bit2	bit1	bit0
STILL	0	0	0	0
x1	0	0	0	1
SEARCH1	0	1	0	0
SEARCH2	0	1	0	1
SEARCH3	0	1	1	0
SEARCH4	0	1	1	1
SEARCH5	1	0	0	0

• CTL Data Sense

For acquiring lapse counter of selected deck in hours, minutes and seconds.

	1st Byte	2nd Byte	3rd Byte	4th Byte	5th Byte	6th Byte	7th Byte	8th Byte
CTL Data Sense	Hr (Tens)	Hr (Ones)	Min (Tens)	Min (Ones)	Sec (Tens)	Sec (Ones)	Frame (Tens)	Frame (Ones)
D9	3*	3*	3*	3*	3*	3*	3*	3*
E.g. (01:23:45)	30	31	32	33	34	35	30	30

E.g. : When time lapse counter is 1 hr 23 min 45 sec.

Frame is fixed as 0.

• JVC Status Sense

	1byte	2byte	3byte	4byte
	HDD/BD/SD	HDD/BD/SD	HDD/BD/SD	HDD/BD/SD
bit7	1 (Fixed)	0 (Fixed)	1 (Fixed)	1 (Fixed)
bit6	0 (Fixed)	0 (Fixed)	0 (Fixed)	1 (Fixed)
bit5	0 (Fixed)	1 (Fixed)	0 (Fixed)	0 (Fixed)
bit4	0 (Fixed)	0 (Fixed)	0 (Fixed)	0 (Fixed)
bit3	0 (Fixed)	Refer to the DISC TYPE table below.	0 (Fixed)	During dubbing (Including PAUSE)
bit2	0 (Fixed)	Refer to the DISC TYPE table below.	0 (Fixed)	0 (Fixed)
bit1	0 (Fixed)	Refer to the DISC TYPE table below.	0 (Fixed)	0 (Fixed)
bit0	1 (Fixed)	Refer to the DISC TYPE table below.	During dubbing (Including PAUSE)	0 (Fixed)

• DISC TYPE

	bit3	bit2	bit1	bit0		bit3	bit2	bit1	bit0
DVD	0	0	0	0	CD	0	1	1	1
DVD-RAM	0	0	0	1	BD-ROM	1	0	0	0
DVD-R	0	0	1	0	BD-R	1	0	0	1
DVD-RW	0	0	1	1	BD-RE	1	0	1	0
DVD+R	0	0	0	0	No disc	1	1	1	1
DVD+RW	0	0	0	0	Unknown	1	1	1	0

When SD deck is selected, the values are fixed as bit3:0, bit2:0, bit1:1 and bit0:0.

Language Code List

Code	Language	Code	Language	Code	Language
AA	Afar	HI	Hindi	OS	Ossetian
AB	Abkhazian	HO	Hiri Motu	PA	Panjabi
AF	Afrikaans	HU	Hungarian	FA	Persian
AK	Akan	IG	Igbo	PI	Pali
SQ	Albanian	IS	Icelandic	PL	Polish
AM	Amharic	IO	Ido	PT	Portuguese
AR	Arabic	II	Sichuan Yi	PS	Pashto
AN	Aragonese	IU	Inuktitut	QU	Quechua
HY	Armenian	IE	Interlingue	RM	Rhaeto-Romance
AS	Assamese	IA	Interlingua (International Auxiliary language Association)	RO	Romanian
AV	Avar	ID	Indonesian	RN	Kirundi
AE	Avestan	IK	Inupiak	RU	Russian
AY	Aymara	IT	Italian	SG	Sango
AZ	Azerbaijani	JV	Javanese	SA	Sanskrit
BA	Bashkir	JA	Japanese	SR	Serbia
BM	Bambara	KL	Kalaallisut	HR	Croatian
EU	Basque	KN	Kannada	SI	Sinhala
BE	Belarusian	KS	Kashmiri	SK	Slovak
BN	Bengali	KR	Kanuri	SL	Slovenian
BH	Bihari	KK	Kazakh	SE	Northern Sami
BI	Bislama	KM	Khmer	SM	Samoan
BS	Bosnian	KI	Kikuyu	SN	Shona
BR	Breton	RW	Kinyarwanda	SD	Sindhi
BG	Bulgarian	KY	Kirghiz	SO	Somali
MY	Burmese	KV	Komi	ST	Southern Sotho
CA	Catalan, Valencian	KG	Kongo	ES	Spanish
CH	Chamorro	KO	Korean	SC	Sardinian
CE	Chechen	KJ	Kwanyama	SS	Swati
ZH	Chinese	KU	Kurukh	SU	Sundanese
CU	Church Slavic	LO	Lao	SW	Swahili
CV	Chuvash	LA	Latin	SV	Swedish
KW	Cornish	LV	Latvian	TY	Tahitian
CO	Corsican	LI	Limburgish	TA	Tamil
CR	Cree	LN	Lingala	TT	Tatar
CS	Czech	LT	Lithuanian	TE	Telugu
DA	Danish	LB	Luxembourgish	TG	Tajik

DV	Divehi	LU	Luba-Katanga	TL	Tagalog
NL	Dutch	LG	Ganda	TH	Thai
DZ	Dzongkha	MK	Macedonian	BO	Tibetan
EN	English	MH	Marshallese	TI	Tigrinya
EO	Esperanto	ML	Malayalam	TO	Tongan
ET	Estonian	MI	Māori	TN	Tswana
EE	Ewe	MR	Marathi	TS	Tsonga
FO	Faroese	MS	Malay	TK	Turkmen
FJ	Fijian	MG	Malagasy	TR	Turkish
FI	Finnish	MT	Maltese	TW	Twi
FR	French	MO	Moldavian	UG	Uighur
FY	Western Frisian	MN	Mongolian	UK	Ukrainian
FF	Fulah	NA	Nauruan	UR	Urdu
KA	Georgian	NV	Navajo	UZ	Uzbek
DE	German	NR	South Ndebele	VE	Venda
GD	Scottish Gaelic	ND	North Ndebele	VI	Vietnamese
GA	Irish	NG	Ndonga	VO	Volapük
GL	Galician	NE	Nepali	CY	Welsh
GV	Manx	NN	Norwegian Nynorsk	WA	Walloon
EL	Greek	NB	Norwegian Bokmål	WO	Wolof
GN	Guaraní	NO	Norwegian	XH	Xhosa
GU	Gujarati	NY	Chichewa	YI	Yiddish
HT	Haitian	OC	Occitan	YO	Yoruba
HA	Hausa	OJ	Ojibwa	ZA	Zhuang
HE	Hebrew	OR	Oriya	ZU	Zulu
HZ	Herero	OM	Oromo		

Country Code List

Code	Country Name	Code	Country Name	Code	Country Name
AD	Andorra	GM	Gambia	NU	Niue
AE	United Arab Emirates	GN	Guinea	NZ	New Zealand
AF	Afghanistan	GP	Guadeloupe	OM	Oman
AG	Antigua and Barbuda	GQ	Equatorial Guinea	PA	Panama
AI	Anguilla	GR	Greece	PE	Peru
AL	Albania	GS	South Georgia and South Sandwich Islands	PF	Polynesia
AM	Armenia	GT	Guatemala	PG	Papua New Guinea
AN	Netherlands Antilles	GU	Guam	PH	Philippines
AO	Angola	GW	Guinea-Bissau	PK	Pakistan
AQ	Antarctica	GY	Guyana	PL	Poland
AR	Argentina	HK	Hong Kong	PM	Saint Pierre and Miquelon
AS	American Samoa	HM	Heard and McDonald Islands	PN	Pitcairn Islands
AT	Austria	HN	Honduras	PR	Puerto Rico
AU	Australia	HR	Croatia	PT	Portugal
AW	Aruba	HT	Haiti	PW	Palau
AZ	Azerbaijan	HU	Hungary	PY	Paraguay
BA	Bosnia and Herzegovina	ID	Indonesia	QA	Qatar
BB	Barbados	IE	Ireland	RE	Reunon Island
BD	Bangladesh	IL	Israel	RO	Romania
BE	Belgium	IN	India	RU	Russian Federation
BF	Burkina Faso	IO	British Indian Ocean Territory	RW	Rwanda
BG	Bulgaria	IQ	Iraq	SA	Saudi Arabia
BH	Bahrain	IR	Iran	SB	Solomon Islands
BI	Burundi	IS	Iceland	SC	Seychelles
BJ	Benin	IT	Italy	SD	Sudan
BM	Bermuda	JM	Jamaica	SE	Sweden
BN	Brunei	JO	Jordan	SG	Singapore
BO	Bolivia	JP	Japan	SH	Saint Helena
BR	Brazil	KE	Kenya	SI	Slovenia
BS	Bahamas	KG	Kyrgyzstan	SJ	Svalbard and Jan Mayen Islands
BT	Bhutan	KH	Cambodia	SK	Slovakia
BV	Bouvet Island	KI	Kiribati	SL	Sierra Leone
BW	Botswana	KM	Comoros	SM	San Marino
BY	Belarus	KN	Saint Kitts and Nevis	SN	Senegal
BZ	Belize	KP	Korea, Democratic People's Republic of	SO	Somalia
CA	Canada	KR	Korea, Republic of	SR	Suriname
CC	Cocos Islands	KW	Kuwait	ST	Sao Tome and Principe
CF	Central African Republic	KY	Cayman Islands	SV	El Salvador
CG	Congo, Republic of	KZ	Kazakhstan	SY	Syria
CH	Switzerland	LA	Laos	SZ	Swaziland
CI	Cote d'Ivoire	LB	Lebanon	TC	Turks and Caicos Islands

CK	Cook Islands	LC	Saint Lucia	TD	Chad
CL	Chile	LI	Liechtenstein	TF	French Southern Territories
CM	Cameroon	LK	Sri Lanka	TG	Togo
CN	China	LR	Liberia	TH	Thailand
CO	Colombia	LS	Lesotho	TJ	Tajikistan
CR	Costa Rica	LT	Lithuania	TK	Tokelau
CU	Cuba	LU	Luxembourg	TM	Turkmenistan
CV	Cape Verde	LV	Latvia	TN	Tunisia
CX	Christmas Island	LY	Libya	TO	Tonga
CY	Cyprus	MA	Morocco	TP	East Timor
CZ	Czech Republic	MC	Monaco	TR	Turkey
DE	Germany	MD	Moldova	TT	Trinidad and Tobago
DJ	Djibouti	MG	Madagascar	TV	Tuvalu
DK	Denmark	MH	Marshall Islands	TW	Taiwan
DM	Dominica, Commonwealth of	ML	Mali	TZ	Tanzania
DO	Dominican Republic	MM	Myanmar	UA	Ukraine
DZ	Algeria	MN	Mongolia	UG	Uganda
EC	Ecuador	MO	Macau	UM	Minor Outlying Islands
EE	Estonia	MP	Northern Mariana Islands	US	United States
EG	Egypt	MQ	Martinique	UY	Uruguay
EH	Western Sahara	MR	Mauritania	UZ	Uzbekistan
ER	Eritrea	MS	Montserrat	VA	Vatican
ES	Spain	MT	Malta	VC	Saint Vincent and the Grenadine
ET	Ethiopia	MU	Mauritius	VE	Venezuela
FI	Finland	MV	Maldives	VG	British Virgin Islands
FJ	Fiji	MW	Malawi	VI	Virgin Islands of the United States
FK	Falkland Islands (Malvinas)	MX	Mexico	VN	Vietnam
FM	Micronesia (Federated States of)	MY	Malaysia	VU	Vanuatu
FO	Faroe Islands	MZ	Mozambique	WF	Wallis and Futuna
FR	France	NA	Namibia	WS	Samoa
FX	France, Metropolitan	NC	New Caledonia	YE	Yemen
GA	Gabon	NE	Niger	YT	Mayotte
GB	United Kingdom of Great Britain and Northern Ireland	NF	Norfolk Island	YU	Yugoslavia
GD	Grenada	NG	Nigeria	ZA	South Africa
GE	Georgia	NI	Nicaragua	ZM	Zambia
GF	French Guiana	NL	Netherlands	ZR	Zaire
GH	Ghana	NO	Norway	ZW	Zimbabwe
GI	Gibraltar	NP	Nepal		
GL	Greenland	NR	Nauru		

Using the HDMI Consumer Electronics Control (HDMI CEC)

HDMI Consumer Electronics Control

- By using a HDMI cable to connect this unit with a TV that supports the HDMI CEC standard, this unit and the TV can be linked and operated together.
- HDMI CEC (Consumer Electronics Control) is an industrial standard that allows HDMI devices to be linked and operated among each other by connecting them with a HDMI cable.

HDMI Consumer Electronics Control operations

- Perform the following operations when this unit is turned on, and the TV will switch automatically to the HDMI input that this unit is connected to.
 - Playback from HDD, BD/DVD or SD CARD
 - Press the [NAVIGATION] or [SETUP] button
- Turning off the power for the TV will also turn the power off for this unit automatically.
If HDD, BD/DVD or SD CARD is being used for dubbing, the power will be turned off after dubbing finishes.

Using HDMI Consumer Electronics Control (activating the function)

1 Connect this unit to a TV that is HDMI CEC compatible using a HDMI cable

2 Change the setting of “HDMI-CEC” to “ON”.

- Check the monitor (TV) setting if the HDMI CEC function does not work.

Memo:

- If you are not using the HDMI CEC function (deactivating), change the setting of “HDMI-CEC” to “OFF”.

Note:

- The HDMI CEC function cannot be used if a TV that is not compatible with HDMI CEC has been connected.
- If a HDMI cable is not used for connecting, the HDMI CEC function will not be usable.

Creating a Seamless BD

When titles are imported into the HDD in the HD quality from a video camera, or when edited titles (e.g., after applying scene delete) are dubbed to a disc, seamless playback may not be possible at the joints of scenes. In this case, perform dubbing after executing “SEAMLESS” under the “MODE CHANGE” setting menu.

For details, refer to “Mode conversion” (☞ page 73) .

Creating a seamless BD that uses “MODE CONVERSION” (seamless conversion, recording mode conversion)

■ Procedures to create a seamless BDMV

File to import	If you do not want to perform scene delete/ chapter delete	If you want to perform scene delete/chapter delete
AVCHD	Recording mode conversion	Seamless conversion
MOV*	Conversion not required	Seamless conversion
SD-VIDEO(HD)* HDV	Recording mode conversion after seamless conversion	Recording mode conversion after seamless conversion

SD-VIDEO(HD)* : SD-VIDEO(JVC Everio MPEG2 TS)

MOV* : MOV files that are taken in SP mode using the JVC ProHD Camcorder GY-HM700/100

■ Procedures to create a seamless BDAV

File to import	If you do not want to perform scene delete/ chapter delete	If you want to perform scene delete/chapter delete
AVCHD	Conversion not required	Seamless conversion
MOV*	Conversion not required	Seamless conversion
SD-VIDEO(HD)* HDV	Seamless conversion	Seamless conversion

SD-VIDEO(HD)* : SD-VIDEO(JVC Everio MPEG2 TS)

MOV* : MOV files that are taken in SP mode using the JVC ProHD Camcorder GY-HM700/100

Memo:

- During dubbing to BDMV, the recording mode cannot be specified.
- Do not perform recording mode conversion before seamless conversion. Otherwise, seamless conversion cannot be performed.
- If scene delete or chapter delete is applied to a title, it cannot be dubbed to a BDMV disc without performing seamless conversion.
- For titles that use the H.264/AVC video compression format such as AVCHD, titles using B-frames as reference for B-frames (pyramidal reference format) are not supported.
- For titles that are imported into the HDD in the SD picture quality, you can create a seamless DVD by setting “SEAMLESS PLAYBACK” under the “Setting Menu List” to “ON”, followed by performing re-encode dubbing.

Refer to “SEAMLESS PLAYBACK” (☞ page 77) .

Troubleshooting

Problem	Symptom	Action	Reference Page
Power does not turn on	The "HELLO" message remains displayed, and the unit does not start up.	Press the [RESET] button on the front panel. If it does not start up, stop using this unit, unplug the plug from the power point, and bring it to the dealer or "Service Center".	(☞ page 13)
"FAN LOCKED" is displayed on the display window of this unit	The cooling fan motor is not working.	The cooling fan motor is spoiled. Remove the power plug from the power point, and consult the dealer from which this product is purchased, or any nearby JVC Servicing Center.	-
Power turns off automatically	The "AUTO POWER (OFF)" setting is set to "2 HOURS" or "6 HOURS".	Change the "AUTO POWER (OFF)" setting of "SETUP" to "OFF".	(☞ page 75)
	The temperature of this unit has rose, and operation has ceased for safety purposes.	Place this unit in an area with ventilation if possible, and wait approximately 30 minutes for it to cool down.	-
The power turns on automatically	The "HDMI-CEC" setting is set to "ON".	Change the "HDMI-CEC" setting of "CONNECTION" to "OFF".	(☞ page 81)
Input cannot be switched	i.LINK connection is currently being established.	Cancel importing, or wait until the connection ends.	(☞ page 37)
There are no video images on the monitor	Monitor only supports RGB input.	Set "HDMI --> DVI COLOR" in the setting menu to "RGB FIX".	(☞ page 81)
	"HDCP ERROR" is displayed.	Use a monitor that supports HDCP.	-
	Video images may be distorted during reencoding/dubbing when the monitor (TV) is connected to this unit using a HDMI cable, or when the screen resolution is set to "1080p".	This is not a malfunction. Change the "HDMI OUTPUT RESOLUTION" to a value other than "1080p" (e.g., 1080i) if you find it annoying.	(☞ page 80)
Screen is distorted	Video images may be distorted during reencoding/dubbing when the monitor (TV) is connected to this unit using a HDMI cable, or when the screen resolution is set to "1080p".	This is not a malfunction. Change the "HDMI OUTPUT RESOLUTION" to a value other than "1080p" (e.g., 1080i) if you find it annoying.	(☞ page 24)
There is no audio sound	The "HDMI AUDIO OUTPUT" setting is set to "OFF".	Change the "HDMI AUDIO OUTPUT" setting of "CONNECTION" to "ON".	(☞ page 81)
	The amplifier does not support "BITSTREAM" output.	Use an amplifier that supports bitstream output.	(☞ page 78)
Dubbing cannot be performed	The title to be dubbed is copyright protected.	Titles that are copyright-protected cannot be dubbed. Select a title that is not copyright-protected.	(☞ page 23)
	A finalized disc has been inserted.	Insert a disc that has not been finalized.	-
	The disc is not formatted.	Format the disc.	(☞ page 25)
	The SD card is write-protected.	Remove the SD card and remove the write protect lock.	(☞ page 27)
High-speed dubbing cannot be performed for EP mode titles	Dubbing cannot be performed and "SOME TITLES CANNOT BE DUBBED" is displayed when trying to perform high-speed dubbing of a EP mode title to a DVD-VIDEO mode disc.	Set "HIGH-SPEED DUBBING" in the settings menu to "4:3" before recording or importing in the EP mode.	(☞ page 24) (☞ page 77)

Troubleshooting (Continued)

Problem	Symptom	Action	Reference Page
Data cannot be imported	The title to be dubbed is copyright protected.	Titles that are copyright-protected cannot be dubbed. Select a title that is not copyright-protected.	(☞ page 23)
	The number of titles stored in the HDD has reached the maximum amount.	Delete or combine the titles in the HDD to reduce the amount of titles to less than 500.	(☞ page 62)
	The remaining space on the HDD is running out.	Delete the titles in the HDD to increase the remaining space.	(☞ page 62)
The title/group name cannot be changed	Protection of the title/group name is turned on.	Turn protection off for the title/group name.	(☞ page 64)
The remote control unit does not work	The battery of the remote control unit has run out.	Change new batteries for the remote control.	(☞ page 16)
	The remote control code of this unit and the remote control unit are different from each other.	Change the "REMOTE CONTROL CODE" for the remote control to the same number used by this unit.	(☞ page 16)
	A "LOCKED" message appears on the display window of the unit.	Disable the "mode lock" setting.	(☞ page 82)
The disc cannot be ejected	A "LOCKED" message appears on the display window of the unit.	Disable the "tray lock" setting.	(☞ page 82)
	The "READING" message does not disappear from the unit's display window, and the disc tray does not open when the [▲] button is pressed.	Pressing the [▲] button at the front of the unit for five seconds or longer opens the disc tray. To close the disc tray after removing the disc, press the [⏻/] button, and wait until the tray is closed and power is turned off. (If the disc tray does not open after pressing the [▲] button for five seconds or longer, consult our authorized dealer.)	-
The disc cannot be played	A disc that cannot be played on this unit is inserted.	Confirm that the disc is playable on this unit.	(☞ page 10)
	The region code of the BD or DVD is different from that of this unit.	Confirm that the region number is playable on this unit.	(☞ page 10)
	An unfinalized DVD disc that is recorded using another device is inserted.	Use that device to finalize the disc.	-
Output is at 480i regardless of the component output resolution setting	The component output setting may be changed to 480i after viewing at a setting of 1080/24p using a HDMI connection.	Turn the power off, and turn it on again.	-
The aspect ratios of the HDMI output and component output are different	When two monitors are connected respectively to the HDMI output and component output terminals of this unit, the screen aspect ratio of the component output may not be appropriate if "VIDEO PRIORITY MODE" is set to "HDMI".	When two monitors are connected simultaneously, users are recommended to set "VIDEO PRIORITY MODE" to "COMPONENT".	(☞ page 80)

Specifications

■ General

Power requirement
AC 120 V \sim , 60 Hz

Power consumption

Power on : 34 W

Power off : 3.0 W

Laser specification

For CD

Wavelength : 779 nm to 789 nm

Output : No hazardous radiation is emitted with the safety protection.

For DVD

Wavelength : 656 nm to 663 nm

Output : No hazardous radiation is emitted with the safety protection.

For BD

Wavelength : 400 nm to 410 nm

Output : No hazardous radiation is emitted with the safety protection.

Temperature

Operating : 5 °C to 35 °C (41 °F to 95 °F)

Storage : -20 °C to 60 °C (-4 °F to 140 °F)

Operating position : Horizontal only

Dimensions (W x H x D) : 435 mm x 70 mm x 351 mm
(17-1/10" x 2-6/8" x 13-13/16")

Weight

SR-HD1500US : 5.1 kg (11.2 lbs)

SR-HD1250US : 5.0 kg (11.0 lbs)

■ Input/Output

Video input : 1.0 Vp-p, 75 Ω (BNC)

Video output : 1.0 Vp-p, 75 Ω (BNC)

Audio input : Max 2 Vrms / 10 k Ω (pin jack)

Audio output : 2 Vrms / 10 k Ω terminated (pin jack)

S-video input

Y : 1.0 Vp-p, 75 Ω

C : 0.286 Vp-p, 75 Ω

S-video output

Y : 1.0 Vp-p, 75 Ω

C : 0.286 Vp-p, 75 Ω

DV : 4-pin for HDV/DV IN

Remote Input : ϕ 3.5 mm Jack

Serial Command: D-SUB 9-PIN

Component video output:

Y : 1.0 Vp-p, 75 Ω

CB/CR, PB/PR : 0.7 Vp-p, 75 Ω

Memo:

- Corresponding to copy protection

Digital audio output:

Optical : PCM, AAC, Dolby Digital and DTS

HDMI output

19-pin type A

(Deep Color, x.v.Color, Ver1.3)

USB terminal

USB2.0

■ SD memory card

SD, SDHC

■ HDD Deck

SR-HD1500US : 500 GB

SR-HD1250US : 250 GB

Recording compression system

Video

MPEG2 (VBR)

H.264/AVC

Audio

Dolby Digital (2 ch)

Linear PCM (2ch, XP mode only)

■ BD/DVD Deck

Recording compression system

Video

MPEG2 (CBR/VBR)

H.264/AVC

Audio

Dolby Digital (2 ch)

Linear PCM (2ch, XP mode only)

Region code

BD : Region A

DVD : #1

■ ACCESSORIES

Provided accessories

- AC power cord
- Audio/Video cable
- BNC male to RCA female adapter
- Infrared remote control unit
- "AA" battery x 2
- CD-ROM

Index

- A**
 AUDIO CABLE 14, 18, 17
 AUDIO LANGUAGE 56, 76, 89
 AUDIO/SUBTITLE SETTINGS 56
- B**
 BD (BD-R/BD-RE) 9, 10, 25, 39, 58, 93
 BD MIX SOUND 79
 BD VIDEO DATA 8
 BDAV 9, 10, 24
 BDMV 9, 10, 24
 BD-ROM 10, 56, 93
 BD-VIDEO RATINGS 76
 BLUE BACK 79
- C**
 CHANGE ANGLE 56
 CHANGE AUDIO OUTPUT 56
 CHANGE CHAPTER 56
 CHAPTER EDIT 50, 67
 CHAPTER MARK 16, 51, 67, 68
 COMPONENT OUTPUT 81
 COMPONENT VIDEO CABLE 14, 17
 CONNECTION 17, 18, 19, 80
 COUNTRY CODE LIST 76, 96
- D**
 DATE DISPLAY STYLE 21, 75
 DETAIL SETTING 57
 DIGITAL NOISE REDUCTION 57
 DIMMER (POWER ON) 75
 DISPLAY WINDOW 13, 14, 75, 82
 Dolby Digital 77, 78
 Dolby Digital Plus/TrueHD 78
 DTS 10, 78
 DTS-HD 79
 DUAL DISC 11
 DVD (DVD-R/DVD-RW) 9, 10, 23, 25, 30, 39, 46, 53, 58, 72, 93
 DVD VIDEO 10, 24, 30, 32, 76
- F**
 FINALIZE 10, 41, 44, 58
- H**
 HDMI 14, 80, 81
 HDMI AUDIO OUTPUT 81
 HDMI CABLE 14, 17, 98
 HDMI OUTPUT RESOLUTION 80
 HDMI-CEC 81, 98
 HIGH-SPEED DUBBING 10, 23, 24, 39, 77
- I**
 i.LINK 13, 18, 23, 29, 37
- J**
 JPEG 24, 29, 30, 33, 35, 42, 55
- L**
 LANGUAGE CODE 76, 94
 LOCKING THE DISC TRAY 82
- M**
 MENU LANGUAGE 76
 MODE LOCK 82
- MPEG2 9
- O**
 ON SCREEN 12, 79
 OPTICAL 14, 18, 78
 OSD LANGUAGE 79
- P**
 PICTURE QUALITY 23, 28, 40, 57
 PLAYBACK NAVIGATION 15, 43, 48
 PLAYBACK SETTINGS 16, 52, 56, 76
 PROGRESSIVE OUTPUT 57
- R**
 RECORDING MODE 13, 15, 23, 24, 28, 47, 50, 87
 REGION CODE 10
 REMOTE CONTROL 13, 14, 15, 16, 82
 REMOTE CONTROL CODE 16, 75
 RESUME POINT 51, 53, 54, 77
 RS-232C 14, 19, 83
- S**
 SCREEN SAVER 79
 SEAMLESS PLAYBACK 77
 SETTING THE DATE/TIME 20
 SUBTITLE LANGUAGE 56, 76
 S-VIDEO 14, 17, 18, 81
- T**
 TIME DISPLAY STYLE 22, 75
- U**
 USB 13, 18, 23, 29, 33
- V**
 VIDEO CABLE 14, 17
 VIDEO MODE 9, 10, 77
 VIDEO INPUT SETTING 81
 VIDEO SETTINGS 57
 VR MODE 9, 10

SR-HD1500US/SR-HD1250US
BLU-RAY DISC & HDD RECORDER

JVC

Free Manuals Download Website

<http://myh66.com>

<http://usermanuals.us>

<http://www.somanuals.com>

<http://www.4manuals.cc>

<http://www.manual-lib.com>

<http://www.404manual.com>

<http://www.luxmanual.com>

<http://aubethermostatmanual.com>

Golf course search by state

<http://golfingnear.com>

Email search by domain

<http://emailbydomain.com>

Auto manuals search

<http://auto.somanuals.com>

TV manuals search

<http://tv.somanuals.com>