

JVC

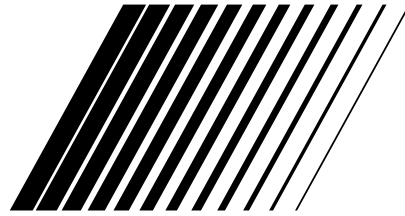

Blu-ray Disc Player

XV-BP10 XV-BP11

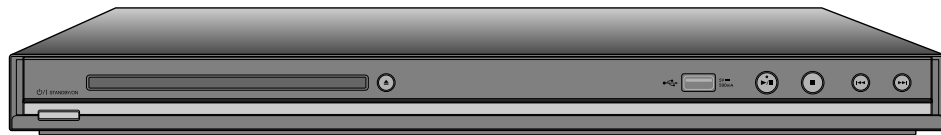

x.v.Color



INSTRUCTIONS

For customer use:
Enter below the Model No. and
Serial No. which are located on the
rear of cabinet. Retain this
information for future reference.

Model No. _____

Serial No. _____

LVT2101-001A
[J]



CAUTION: TO REDUCE THE RISK OF ELECTRIC SHOCK DO NOT REMOVE COVER (OR BACK) NO USER-SERVICEABLE PARTS INSIDE REFER SERVICING TO QUALIFIED SERVICE PERSONNEL.



This lightning flash with arrowhead symbol within an equilateral triangle is intended to alert the user to the presence of uninsulated dangerous voltage within the product's enclosure that may be of sufficient magnitude to constitute a risk of electric shock to persons.



The exclamation point within an equilateral triangle is intended to alert the user to the presence of important operating and maintenance (servicing) instructions in the literature accompanying the product.

WARNING: TO PREVENT FIRE OR ELECTRIC SHOCK HAZARD, DO NOT EXPOSE THIS PRODUCT TO RAIN OR MOISTURE.

WARNING: Do not install this equipment in a confined space such as a book case or similar unit.

CAUTION:

Do not block any ventilation openings. Install in accordance with the manufacturer's instructions. Slots and openings in the cabinet are provided for ventilation and to ensure reliable operation of the product and to protect it from over heating. The openings shall never be blocked by placing the product on a bed, sofa, rug or other similar surface. This product shall not be placed in a built-in installation such as a bookcase or rack unless proper ventilation is provided or the manufacturer's instruction have been adhered to.

IMPORTANT FOR LASER PRODUCTS

1. CLASS 1 LASER PRODUCT
2. **CAUTION:** Do not open the top cover or cabinet. There are no user serviceable parts inside the unit; leave all servicing to qualified service personnel.
3. **CAUTION:** CLASS 3B VISIBLE AND INVISIBLE LASER RADIATION WHEN OPEN. AVOID EXPOSURE TO THE BEAM.
4. REPRODUCTION OF LABEL: CAUTION LABEL, PLACED INSIDE THE UNIT.

| | |
|----------|--|
| CAUTION | CLASS 3B VISIBLE AND INVISIBLE LASER RADIATION WHEN OPEN. AVOID EXPOSURE TO THE BEAM. |
| ADVARSEL | KLASSE 3B SYNLIG OG USYNLIG LASERSTRÅLING VED ÅBNING. UNDGÅ UDSAETTELSE FOR STRÅLING. |
| ADVARSEL | KLASSE 3B SYNLIG OG USYNLIG LASERSTRÅLING NÅR DEKSEL ÅPENS. UNNGÅ EKSPONERING FOR STRÅLEN. |
| VARNING | KLASSE 3B SYNLIG OCH OSYNLIG LASERSTRÅLNING NÅR DENNA DEL ÄR ÖPPNAD. STRÅLEN ÄR FARLIG. |
| VARO | AVATTAESSA OLET ALTTIINA LUOKAN 3B NÄKYYVÄÄ JA NÄKYMÄTÖNTÄ LASERSÄTEILYLLE VARO ALTISTUMISTA SÄTEELLE. |
| VORSICHT | SICHTBARE UND UNSICHTBARE LASERSTRAHLUNG KLASSE 3B, WENN ABDECKUNG GEÖFFNET. NICHT DEM STRAHL AUSSETZEN. |

CAUTION: The apparatus shall not be exposed to water (dripping or splashing) and no objects filled with liquids, such as vases, shall be placed on the apparatus.

CAUTION concerning the Power Cord

Most appliances recommend they be placed upon a dedicated circuit;

That is, a single outlet circuit which powers only that appliance and has no additional outlets or branch circuits. Check the specification page of this owner's manual to be certain.

Do not overload wall outlets. Overloaded wall outlets, loose or damaged wall outlets, extension cords, frayed power cords, or damaged or cracked wire insulation are dangerous. Any of these conditions could result in electric shock or fire. Periodically examine the cord of your appliance, and if its appearance indicates damage or deterioration, unplug it, discontinue use of the appliance, and have the cord replaced with an exact replacement part by an authorized servicer.

Protect the power cord from physical or mechanical abuse, such as being twisted, kinked, pinched, closed in a door, or walked upon. Pay particular attention to plugs, wall outlets, and the point where the cord exits the appliance.

To disconnect power from the mains, pull out the mains cord plug. When installing the product, ensure that the plug is easily accessible.

FCC WARNING: This equipment may generate or use radio frequency energy. Changes or modifications to this equipment may cause harmful interference unless the modifications are expressly approved in the instruction manual. The user could lose the authority to operate this equipment if an unauthorized change or modification is made.

REGULATORY INFORMATION: FCC Part 15

This equipment has been tested and found to comply with the limits for a Class B digital device, pursuant to Part 15 of the FCC Rules. These limits are designed to provide reasonable protection against harmful interference when the product is operated in a residential installation. This product generates, uses, and can radiate radio frequency energy and, if not installed and used in accordance with the instruction manual, may cause harmful interference to radio communications. However, there is no guarantee that interference will not occur in a particular installation. If this product does cause harmful interference to radio or television reception, which can be determined by turning the product off and on, the user is encouraged to try to correct the interference by one or more of the following measures:

- Reorient or relocate the receiving antenna.
- Increase the separation between the product and receiver.
- Connect the product into an outlet on a circuit different from that to which the receiver is connected.
- Consult the dealer or an experienced radio/TV technician for help.



As an ENERGY STAR® Partner, JVC has determined that this product or product models meet the ENERGY STAR® guidelines for energy efficiency.

- When power off mode, power consumption is under 0.01W.

IMPORTANT SAFETY INSTRUCTIONS

1. Read these instructions.
2. Keep these instructions.
3. Heed all warnings.
4. Follow all instructions.
5. Do not use this apparatus near water.
6. Clean only with dry cloth.
7. Do not block any ventilation openings. Install in accordance with the manufacturer's instructions.
8. Do not install near any heat sources such as radiators, heat registers, stoves, or other apparatus (including amplifiers) that produce heat.
9. Do not defeat the safety purpose of the polarized or grounding-type plug. A polarized plug has two blades with one wider than the other. A grounding type plug has two blades and a third grounding prong. The wide blade or the third prong are provided for your safety. If the provided plug does not fit into your outlet, consult an electrician for replacement of the obsolete outlet.
10. Protect the power cord from being walked on or pinched particularly at plugs, convenience receptacles, and the point where they exit from the apparatus.
11. Only use attachments/accessories specified by the manufacturer.
12. Use only with the cart, stand, tripod, bracket, or table specified by the manufacturer, or sold with apparatus. When a cart is used, use caution when moving the cart/product combination to avoid injury from tip-over.



13. Unplug this apparatus during lightning storms or when unused for long periods of time.
14. Refer all servicing to qualified service personnel. Servicing is required when the product has been damaged in any way, such as power-supply cord or plug is damaged, liquid has been spilled or objects have fallen into the apparatus, the product has been exposed to rain or moisture, does not operate normally, or has been dropped.

Notes on Copyrights

- Because AACS (Advanced Access Content System) is approved as content protection system for BD format, similar to use of CSS (Content Scramble System) for DVD format, certain restrictions are imposed on playback, analog signal output, etc., of AACS protected contents. The operation of this product and restrictions on this product may vary depending on your time of purchase as those restrictions may be adopted and/or changed by AACS after the production of this product.
Furthermore, BD-ROM Mark and BD+ are additionally used as content protection systems for BD format, which imposes certain restrictions including playback restrictions for BD-ROM Mark and/or BD+ protected contents. To obtain additional information on AACS, BD-ROM Mark, BD+, or this product, please contact an authorized Customer Service Center.
- Many BD-ROM/DVD discs are encoded with copy protection. Because of this, you should only connect your player directly to your TV, not to a VCR. Connecting to a VCR results in a distorted picture from copy-protected discs.
- This product incorporates copyright protection technology that is protected by U.S. patents and other intellectual property rights. Use of this copyright protection technology must be authorized by Macrovision, and is intended for home and other limited viewing uses only unless otherwise authorized by Macrovision. Reverse engineering or disassembly is prohibited.
- Under the U.S. Copyright laws and Copyright laws of other countries, unauthorized recording, use, display, distribution, or revision of television programs, videotapes, BD-ROM discs, DVDs, CDs and other materials may subject you to civil and/or criminal liability.

Licenses

Java and all Java-based trademarks and logos are trademarks or registered trademarks of Sun Microsystems, Inc. in the United States and other countries.

Manufactured under license from Dolby Laboratories. Dolby and the double-D symbol are trademarks of Dolby Laboratories.

Manufactured under license under U.S. Patent #'s: 5,451,942; 5,956,674; 5,974,380; 5,978,762; 6,226,616; 6,487,535; 7,392,195; 7,272,567; 7,333,929; 7,212,872 & other U.S. and worldwide patents issued & pending. DTS is a registered trademark and the DTS logos, Symbol, DTS-HD and DTS-HD Master Audio | Essential are trademarks of DTS, Inc. © 1996-2008 DTS, Inc. All Rights Reserved.

HDMI, the HDMI logo and High-Definition Multimedia Interface are trademarks or registered trademarks of HDMI licensing LLC.

"DVD Logo" is a trademark of DVD Format/Logo Licensing Corporation.

"x.v.Color" is a trademark of Sony Corporation.

"Blu-ray Disc" is a trademark.

"BONUSVIEW" is trademark of Blu-ray Disc Association.

This product is licensed under the AVC patent portfolio license and VC-1 patent portfolio license for the personal and non-commercial use of a consumer to (i) encode video in compliance with the AVC Standard and VC-1 Standard ("AVC/VC-1 Video") and/or (ii) decode AVC/VC-1 Video that was encoded by a consumer engaged in a personal and non-commercial activity and/or was obtained from a video provider licensed to provide AVC/VC-1 Video. No license is granted or shall be implied for any other use. Additional information may be obtained from MPEG LA, LLC. See <http://www.mpegla.com>.

"AVCHD" and the "AVCHD" logo are trademarks of Panasonic Electric Industrial Co. Ltd and Sony Corporation.

Contents

Introduction6-12

- About the \odot Symbol Display 6
- Symbols Used in this Manual 6
- Notes on Discs 6
- Moisture Condensation 6
- Handling the Unit 6
- Playable Discs 7
- Regional Code 7
- BD-ROM Disc Features 8
- Compatibility Notes 9
- Certain System Requirements 9
- Language setting 9
- Resetting the Player 9
- Using a USB Flash Drive 10
- Using the Home Menu 10
- Front Panel 11
- Rear Panel 11
- Remote Control 12
- Remote Control Operation 12

Installation and Setup13-20

- HDMI connection 13
- Connections to Your TV 14
- Connecting to an Amplifier 15
- Resolution Setting 16
- Initial Settings 17
 - General Operation 17
 - [DISPLAY] Menu 17
 - [LANGUAGE] Menu 18
 - [AUDIO] Menu 18
 - [LOCK] Menu (Parental Control) 19
 - [OTHERS] Menu 20

Operations21-28

- General playback features 21-23
- If a disc menu screen is displayed 24
- Enlarge the playback image 24
- Time Search 24
- Skip Search 24
- Marker Search 24
- Watching from a different angle 24
- Last Scene Memory 24
- Using Color (R, G, B, Y) Buttons 25
- Screen Saver 25
- Changing content list view 25
- Displaying Disc Information On-Screen 25
- Playing a DVD VR Format Disc 26
- Playing an Audio CD or MP3/WMA files 27
- Viewing a Photo file 28

Reference29-33

- Language Codes 29
- Area Codes 29
- Troubleshooting 30
- Specifications 31
- This unit's Audio Output Specifications 32
- Open source software notice 33

Introduction

To ensure proper use of this product, please read this owner's manual carefully and retain for future reference.

This manual provides information on the operation and maintenance of your player. Should the unit require service, contact an authorized service location.

About the Symbol Display

" " may appear on your TV display during operation and indicates that the function explained in this owner's manual is not available on that specific media.

Symbols Used in this Manual

Note:

Indicates special notes and operating features.

Tip:

Indicates tips and hints for making the task easier.

A section whose title has one of the following symbols are applicable only to the disc represented by the symbol.

- ALL** All discs listed below
- BD** BD-ROM disc
- DVD** DVD-Video, DVD-R/RW, +R/+RW in Video mode or VR mode and finalized
- AVCHD** DVD-R/RW, +R/+RW in AVCHD format
- ACD** Audio CDs
- MP3** MP3 files
- WMA** WMA files
- PHOTO** Photo files

Notes on Discs

Handling Discs

Do not touch the playback side of the disc. Hold the disc by the edges so that fingerprints do not get on the surface. Never stick paper or tape on the disc.

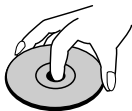

Storing Discs

After playing, store the disc in its case. Do not expose the disc to direct sunlight or sources of heat and never leave it in a parked car exposed to direct sunlight.

Cleaning Discs

Fingerprints and dust on the disc can cause poor picture quality and sound distortion. Before playing, clean the disc with a clean cloth. Wipe the disc from the center out.

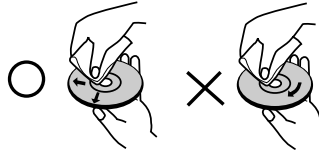

Do not use strong solvents such as alcohol, benzene, thinner, commercially available cleaners, or anti-static spray intended for older vinyl records.

Moisture Condensation

Never operate this product immediately after moving it from a cold location to a warm location. Leave it for two or three hours without operating it. If you use this product in such a situation, it may damage discs and internal parts.

Handling the Unit

When shipping the unit

Please save the original shipping carton and packing materials. If you need to ship the unit, for maximum protection, re-pack the unit as it was originally packed at the factory.

Keeping the exterior surfaces clean

- Do not use volatile liquids such as insecticide spray near the unit.
- Wiping with strong pressure may damage the surface.
- Do not leave rubber or plastic products in contact with the unit for a long period of time.

Cleaning the unit

To clean the player, use a soft, dry cloth. If the surfaces are extremely dirty, use a soft cloth lightly moistened with a mild detergent solution. Do not use strong solvents such as alcohol, benzene, or thinner, as these might damage the surface of the unit.

Maintaining the Unit

The unit is a high-tech, precision device. If the optical pick-up lens and disc drive parts are dirty or worn, the picture quality could be diminished.

For details, please contact your nearest authorized service center.

Playable Discs



Blu-ray Disc

- Discs such as movies that can be purchased or rented
- BD-R/RE discs that contain BDMV, audio titles, MP3, WMA, or Photo files.



DVD-VIDEO

- Discs such as movies that can be purchased or rented



DVD-R

- Video mode and finalized only
- Supports the dual layer disc also
- AVCHD format
- DVD-R discs that contain audio titles, MP3, WMA, or Photo files.



DVD-RW

- VR mode, Video mode and finalized only
- AVCHD format
- DVD-RW discs that contain audio titles, MP3, WMA, or Photo files.

+R

- Finalized disc only
- Supports the dual layer disc also
- AVCHD format
- DVD+R discs that contain audio titles, MP3, WMA, or Photo files.

+RW

- Video mode and finalized only
- AVCHD format
- DVD+RW discs that contain audio titles, MP3, WMA, or Photo files.



Audio CD

- Audio CDs or CD-Rs/CD-RWs in audio CD format that can be purchased



CD-R/CD-RW

- CD-R/CD-RW discs that contain audio titles, MP3, WMA, or Photo files.

AVCHD (Advanced Video Codec High Definition)

- This player can playback AVCHD format discs. These discs are normally recorded and used in camcorders.
- The AVCHD format is a high definition digital video camera format.
- The MPEG-4 AVC/H.264 format is capable of compressing images at higher efficiency than that of the conventional image compressing format.
- Some AVCHD discs use the "x.v.Color" format.
- This player can playback AVCHD discs using "x.v.Color" format.

- Some AVCHD format discs may not play, depending on the recording condition.
- AVCHD format discs need to be finalized.
- "x.v.Color" offers a wider color range than normal DVD camcorder discs.

Regional Code

This unit has a regional code printed on the rear of the unit. This unit can play only BD-ROM or DVD discs labeled same as the rear of the unit or "ALL".

Notes:

- Depending on the conditions of the recording equipment or the CD-R/RW (or DVD-R/RW, +R/+RW) disc itself, some CD-R/RW (or DVD-R/RW, +R/+RW) discs cannot be played on the unit.
- Do not attach any seal or label to either side (the labeled side or the recorded side) of a disc.
- Do not use irregularly shaped CDs (e.g., heart-shaped or octagonal). Doing so may result in malfunctions.
- Depending on the recording software & the finalization, some recorded discs (CD-R/RW or DVD-R/RW, +R/+RW) may not be playable.
- DVD-R/RW, +R/+RW and CD-R/RW discs recorded using a personal computer or a DVD or CD Recorder may not play if the disc is damaged or dirty, or if there is dirt or condensation on the player's lens.
- If you record a disc using a personal computer, even if it is recorded in a compatible format, there are cases in which it may not play because of the settings of the application software used to create the disc. (Check with the software publisher for more detailed information.)
- This player requires discs and recordings to meet certain technical standards in order to achieve optimal playback quality. Pre-recorded DVDs are automatically set to these standards. There are many different types of recordable disc formats (including CD-R containing MP3 or WMA files) and these require certain pre-existing conditions to ensure compatible playback.
- Customers should note that permission is required in order to download MP3 / WMA files and music from the Internet. Our company has no right to grant such permission. Permission should always be sought from the copyright owner.
- This player supports 8 cm disc except Blu-ray Disc.

BD-ROM Disc Features

BD-ROM Discs can store 25 GB (single layer) or 50 GB (dual layer) on a single sided disc - about 5 to 10 times the capacity of a DVD.

BD-ROM Discs also support the highest quality HD video available in the industry (up to 1920 x 1080) - Large capacity means no compromise on video quality. Furthermore, a BD-ROM disc has the same familiar size and look as DVD.

- The following BD-ROM disc features are disc dependent and will vary.
- Appearance and navigation of features will also vary from disc to disc.
- Not all discs will have the features described below.
- BD-ROM, Hybrid disc have both BD-ROM and DVD (or CD) layers on one side. On such discs, BD-ROM layer will be only played back in this player.

Video highlights

The BD-ROM format for movie distribution supports three highly advanced video codecs, including MPEG-2, MPEG4 AVC (H.264), and SMPTE VC1. HD video resolutions are also available:

- 1920 x 1080 HD
- 1280 x 720 HD

For High-Definition Playback

To view high-definition contents from BD-ROM discs, an HDTV is required. Some discs may require HDMI OUT for viewing of high-definition contents. Ability to view high-definition contents in BD-ROM discs may be limited depending on the resolution of your TV.

Graphic planes

Two individual, full HD resolution (1920x1080) graphic planes (layers) are available, on top of the HD video layer. One plane is assigned to video-related, frame accurate graphics (like subtitles), and the other plane is assigned to interactive graphic elements, such as buttons or menus.

For both planes, various wipes, fades and scroll effects may be available.

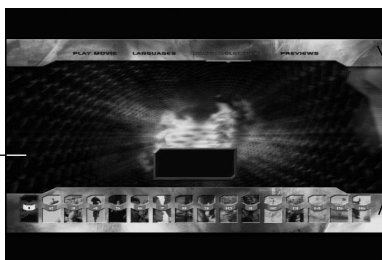

Graphic Plane

HD Video

Menu sounds

When you highlight or select a menu option, sounds can be heard such as button clicks or a voice-over explaining the highlighted menu choice.

Multi-page/PopUp Menus

With DVD-Video, playback is interrupted each time a new menu screen is accessed. Due to BD-ROM disc's ability to preload data from the disc without interrupting playback, a menu can consist of several pages.

You can browse through the menu pages or select different menu paths, while the audio and video remain playing in the background.

Interactivity

Certain BD-ROM Discs may contain animated menus and/or trivia games.

User Browsable Slideshows

With BD-ROM Discs, you can browse through various still pictures while the audio remains playing.

Subtitles

Depending on what is contained on the BD-ROM disc, you may be able to select different font styles, sizes and colors for some subtitles. Subtitles may also be animated, scrolled or faded in and out.

BD-J Interactive Capability

The BD-ROM format supports Java for interactive functions. "BD-J" offers content providers almost unlimited functionality when creating interactive BD-ROM titles.

BD-ROM Disc Compatibility

This player supports only BD-ROM Profile 1.1.

- Discs supporting BONUSVIEW (BD-ROM version 1.1 Profile 1 version 1.1/Final Standard Profile) that allows Virtual packages or Picture-in-Picture functions to be used.

Compatibility Notes

- Because BD-ROM are a new format, certain disc, digital connection and other compatibility issues are possible. If you experience compatibility problems, please contact an authorized Customer Service Center.
- Viewing high-definition content and up-converting standard DVD content may require an HDMI-capable input or HDCP-capable DVI input on your display device.
- Some BD-ROM and DVD discs may restrict the use of some operation commands or features.
- Dolby TrueHD, Dolby Digital Plus and DTS-HD are supported with maximum 7.1 channels if you use HDMI connection for the audio output of the unit.
- You can use a USB Flash Drive that is used to store some disc related information, including downloaded on-line content. The disc you are using will control how long this information is retained.

Certain System Requirements

For high definition video playback:

- High definition display that has HDMI input jack.
- BD-ROM disc with high definition content.
- HDMI or HDCP capable DVI input on your display device is required for some content (as specified by disc authors).
- For up-conversion of standard definition DVD, an HDMI or HDCP capable DVI input on your display device is required for copy protected content.

For Dolby® Digital Plus, Dolby TrueHD and DTS-HD multi-channel audio playback:

- An amplifier/receiver with a built-in (Dolby Digital, Dolby Digital Plus, Dolby TrueHD, DTS or DTS-HD) decoder.
- Main, center, surround speakers and subwoofer as necessary for chosen format.

Language setting

When turned on for the first time, select a language for the [Setup] menu and on-screen display.

1. Press HOME and the [Home Menu] appears.
2. Select [Setup] and press ENTER. The Setup menu appears.

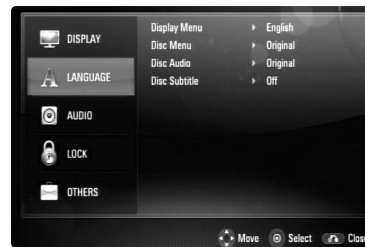

3. Use ▲ / ▼ to select [LANGUAGE] option then press ►.
4. Use ▲ / ▼ to select [Display Menu] option then press ►.
5. Use ▲ / ▼ to select the desired language then press ENTER.
6. Press RETURN or HOME to exit the Setup menu.

Resetting the Player

If you observe any of the following symptoms...

- When the Player is plugged in, but the power will not turn on or off.
- When the display window is not working.
- When the Player does not operate normally.

You can reset the Player as follows:

- Press and hold the STANDBY/ON button for more than five seconds. This will force the Player to power off. Press the STANDBY/ON button again to turn the Player back on.
- Unplug the power cord and then plug the power cord again after more than five seconds.

Using a USB Flash Drive

This unit can play the music and photo files contained on the USB Flash Drive.

Insert/Remove a USB Flash Drive

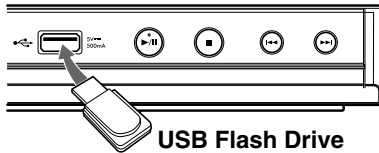

Inserting a USB Flash Drive

Insert straight-in until it fits into place.

Removing a USB Flash Drive

Withdraw the USB Flash Drive carefully.

Notes:

- This unit supports only USB Flash Drive with FAT16 or FAT32 format.
- Do not extract the USB Flash Drive during operation (play, etc.).
- A USB Flash Drive which requires additional program installation when you have connected it to a computer is not supported.
- USB Flash Drive: USB Flash Drive that support USB1.1 and USB2.0.
- Music files (MP3/WMA) and photo files (JPEG/PNG) can be played. For details of operations on each file, refer to relevant pages.
- Regular back up is recommended to prevent data loss.
- If you use a Card Reader, USB extension cable or USB HUB, the USB Flash Drive may not be recognized.
- Some USB Flash Drives may not work with this unit.
- Digital camera and mobile phone are not supported.
- USB Port of the unit cannot be connected to PC. The unit cannot be used as a storage device.
- When take off an active device connecting to USB port, please take it off after switching off the unit.
- When connecting with a USB cable, use the USB 2.0 cable those length is less than 1 m.

Using the USB Flash Drive

1. Connect a USB Flash Drive.
2. Press HOME on the Remote Control.
3. Select [Music] or [Photo] option then press ENTER.
4. Select [USB] then press ENTER.
[MUSIC] or [PHOTO] menu appears.
Details for the menu are on pages 27-28.

Using the Home Menu

From the Home Menu screen you can access all the Media for playback and setting of the unit.

1. Press HOME and the [Home Menu] appears.

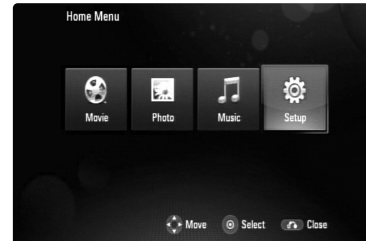

2. Use ◀ / ▶ to select the desired option then press ENTER.

[Movie] – Start video media's playback or displays the [MOVIE] menu.

[Photo] – Displays [PHOTO] menu. (page 28)

[Music] – Displays [MUSIC] menu. (page 27)

[Setup] – Displays [Setup] menu. (page 17)

Note:

When a disc and USB Flash Drive have the contents, it can choose those menus.

About Setup menu:

| Menus | Buttons | Operations |
|--------|---------|------------------------------|
| Move | | Moves the cursor. |
| Select | | Activates the selected item. |
| Close | | Closes the menu. |

Tip:

If you select the [Photo] or [Music] option when a USB Flash Drive is connected and a disc is inserted simultaneously, the menu for selecting a media will appear. Select a media then press ENTER.

For example:

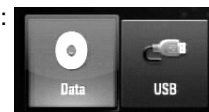

Note:

The unit will be in stop mode then the [Home Menu] will appear if you press HOME during playback.

Front Panel

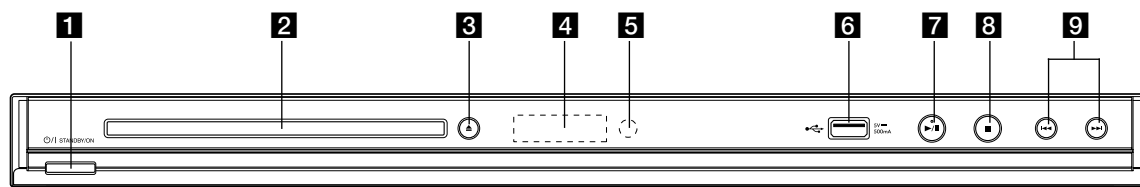

- | | |
|---|--|
| <p>1 ⏻/⏻ (STANDBY/ON) Button Switches the unit ON or OFF.</p> <p>2 Disc Tray Insert a disc here.</p> <p>3 ▲ (OPEN/CLOSE) Opens or closes the disc tray.</p> <p>4 Display Window Shows the current status of the player.</p> <p>5 Remote Sensor Point the Remote Control here.</p> | <p>6 USB Port Connect a USB Flash Drive.</p> <p>7 ▶ / ⏸ (PLAY / PAUSE) Starts playback. Pause playback temporarily, press again to exit pause mode.</p> <p>8 ■ (STOP) Stops playback.</p> <p>9 ⏮ / ⏭ (SKIP) Go to next or previous file/track/chapter.</p> |
|---|--|

Rear Panel

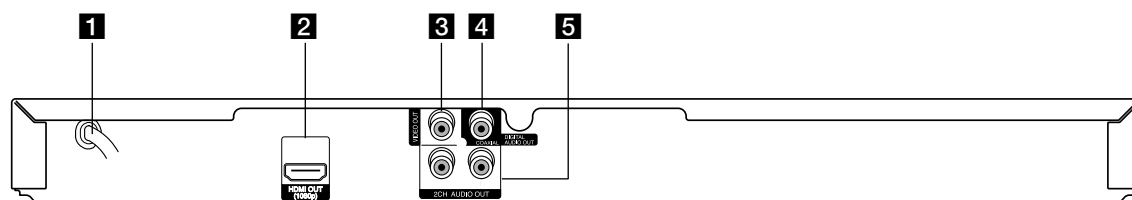

- | | |
|---|---|
| <p>1 AC Power Cord Plug into the power source.</p> <p>2 HDMI OUT (Type A) Connect to TV with HDMI inputs. (Interface for digital audio and video)</p> <p>3 VIDEO OUT Connect to a TV with video inputs.</p> | <p>4 DIGITAL AUDIO OUT (COAXIAL) Connect to digital (coaxial) audio equipment.</p> <p>5 2CH AUDIO OUT (Left/Right) Connect to a TV with 2 channel audio inputs.</p> |
|---|---|

Remote Control

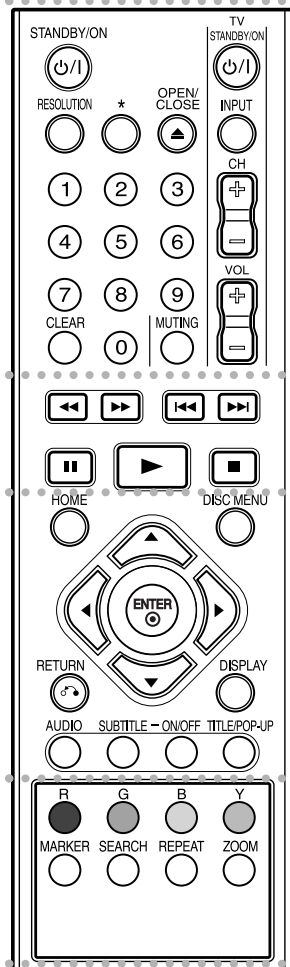

- • • • • **1** • • • • •
- STANDBY/ON** (⏻/⏻): Switches the player ON or OFF.
- RESOLUTION**: Sets the output resolution for HDMI OUT jack.
- * : This button is not available.

- OPEN/CLOSE** (⏮): Opens and closes the disc tray.
- 0-9 numerical buttons**: Select numbered options in a menu.
- CLEAR**: Removes a mark on the search menu or a number when setting the password.
- JVC TV Control Buttons**:
 - **TV STANDBY/ON** (⏻/⏻): Turn the TV on or off.
 - **INPUT**: Switch the TV's input source between the TV and other input sources.
 - **CH (+/-)**: Scan up or down through memorized channels.
 - **VOL (+/-)**: Adjust the volume of the TV.
 - **MUTING**: Temporarily turns TV sound OFF, press again to restore.

1

2

3

4

- • • • • **2** • • • • •
- ◀ / ▶** (**SCAN**): Search backward or forward.
- ⏮ / ⏭** (**SKIP**): Go to next or previous chapter / track / file.
- ⏸** (**PAUSE/STEP**): Pauses playback.
- ▶** (**PLAY**): Starts playback.
- (**STOP**): Stops playback.
- • • • • **3** • • • • •
- HOME**: Displays or exits the [Home Menu].
- DISC MENU**: Accesses menu on a disc.
- Direction buttons**: Select an option in the menu.
- ENTER** (⊙): Acknowledges menu selection.

- RETURN** (↶): Exits or closes the menu, or resumes playback. The resume play function may work depending on the BD-ROM disc.
- DISPLAY**: Displays or exits On-Screen Display.
- AUDIO**: Selects an audio language or audio channel.
- SUBTITLE**: Selects a subtitle language.
- SUBTITLE ON/OFF**: Switches the subtitle on or off.
- TITLE/POP-UP**: Displays the DVD title menu or BD-ROM's popup menu, if available.

- • • • • **4** • • • • •
- Color (R, G, B, Y) buttons**: Use to navigate BD-ROM menus. They are also used for [MOVIE], [PHOTO] and [MUSIC] menu.
- MARKER**: Marks any point during playback.
- SEARCH**: Displays or exits the search menu.
- REPEAT**: Repeat a desired section.
- ZOOM**: Displays or exits the [Zoom] menu.

Remote Control Operation

Point the Remote Control at the remote sensor and press the buttons.

Caution

- Do not put the batteries in the place where young children can reach.

Remote Control Battery Installation

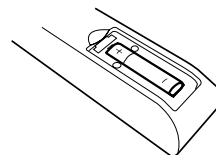

Remove the battery cover on the rear of the Remote Control, and insert a R03 (size AAA) battery with ⊕ and ⊖ matched correctly.

Installation and Setup

HDMI connection

If you have a HDMI TV or monitor, you can connect it to this player using a HDMI cable.

1. Connect the HDMI jack on the player to the HDMI jack on a HDMI compatible TV or monitor (**H**).
2. Set the TV's source to HDMI (refer to TV's Owner's manual).

Notes:

- You must select a HDMI audio output and a maximum sampling frequency that your TV accepts using [HDMI] and [Sampling Freq.] options on the setup menu (see page 18).
- If a connected HDMI device does not accept the audio output of the unit, the HDMI device's audio sound may be distorted or may not output.

Tips:

- When you use HDMI connection, you can change the resolution for the HDMI output. (Refer to "Resolution Setting" on page 16.)
- Select the type of video output from the HDMI OUT jack using [HDMI Color Setting] option on the [Setup] menu (see page 17).

Cautions

- Changing the resolution when the connection has already been established may result in malfunctions. To solve the problem, turn off the player and then turn it on again.
- When the HDMI connection with HDCP is not verified, TV screen is changed to black screen. In this case, check the the HDMI connection, or disconnect the HDMI cable.
- If there is noise or lines on the screen, please check the HDMI cable (length is generally limited to 15ft).

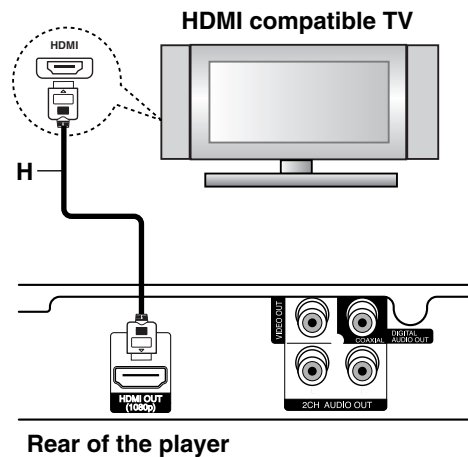

Additional Information for HDMI

- When you connect a HDMI or DVI compatible device make sure of the following:
 - Try switching off the HDMI/DVI device and this player. Next, switch on the HDMI/DVI device and leave it for around 30 seconds, then switch on this player.
 - The connected device's video input is set correctly for this unit.
 - The connected device is compatible with 720x480p, 1280x720p, 1920x1080i or 1920x1080p video input.
- Not all HDCP-compatible HDMI or DVI devices will work with this player.
 - The picture will not be displayed properly with non-HDCP device.
 - This player does not playback and TV screen is changed to black screen.

Connections to Your TV

Tip:

Please refer to the manuals of your TV, Stereo System or other devices as necessary to make the best connections.

Caution

- Make sure the player is connected directly to the TV. Tune the TV to the correct video input channel.
- Do not connect the player's AUDIO OUT jack to the phono in jack (record player) of your audio system.
- Do not connect your player via your VCR. The image could be distorted by the copy protection system.

Video Connection

Connect the VIDEO OUT jack on the player to the video in jack on the TV using a video cable (**V**).

Audio (Left/Right) Connection

Connect the left and right AUDIO OUT jacks of the player to the audio left and right IN jacks on the TV using the audio cables (**A**).

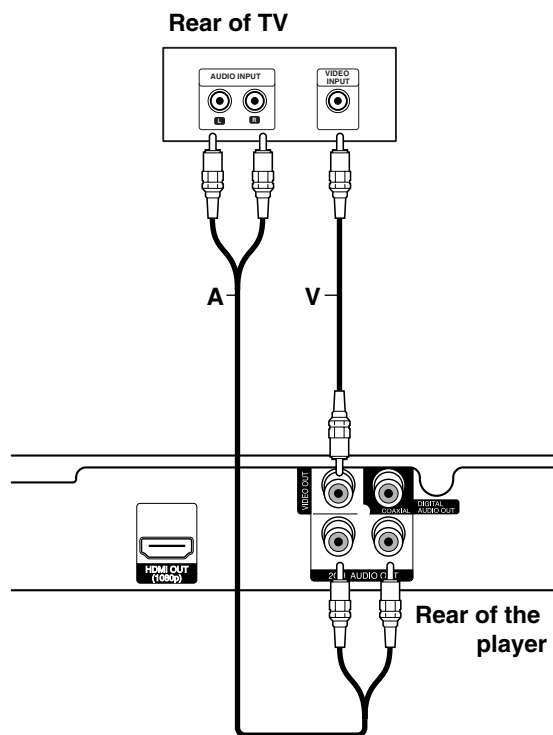

Connecting to an Amplifier

Make one of the following connections, depending on the capabilities of your existing equipment.

Note:

Since many factors affect the type of audio output, see "The unit's Audio Output Specifications" on page 32 for details.

Connecting to an Amplifier via 2 Channel Audio Output

Connect the Left and Right 2CH AUDIO OUT jacks on the player to the audio left and right in jacks on your amplifier, receiver, or stereo system, using audio cables (**A**).

Connecting to an Amplifier via Digital Audio Output (Coaxial)

1. Connect the player's DIGITAL AUDIO OUT jack to the corresponding in jack (COAXIAL **X**) on your amplifier. Use an optional digital (coaxial **X**) audio cable.
2. You will need to activate the player's digital output. (See "[AUDIO] Menu" on pages 18.)

Connecting to an Amplifier via HDMI Output

1. Connect the player's HDMI OUT jack to the corresponding in jack on your amplifier. Use an HDMI cable (**H1**).
2. You will need to activate the player's digital output. (See "[AUDIO] Menu" on pages 18.)

Tip:

Connect the amplifier's HDMI output jack to HDMI input jack on your TV using an HDMI cable (**H2**) if your amplifier has HDMI output jack.

Digital Multi-channel sound

A digital multi-channel connection provides the best sound quality. For this you need a multi-channel Audio/Video Receiver that supports one or more of the audio formats supported by your player. Check the receiver manual and the logos on the front of the receiver. (PCM Stereo, PCM Multi-Ch, Dolby Digital, Dolby Digital Plus, Dolby TrueHD, DTS and/or DTS-HD)

Notes:

- You must select a digital audio output and a maximum sampling frequency that your Amplifier (or AV receiver) accepts using [SPDIF], [HDMI] and [Sampling Freq.] options on the [Setup] menu (see page 18).
- With digital audio connection (SPDIF or HDMI), Disc Menu button sounds of BD-ROM may not be heard if the [SPDIF] or [HDMI] option is set to [Primary Pass-Thru].
- If the audio format of the digital output does not match the capabilities of your receiver, the receiver will produce a strong, distorted sound or no sound at all.
- Multi-channel Digital Surround Sound via digital connection can only be obtained if your receiver is equipped with a Digital Multi-channel decoder.
- To see the audio format of the current disc in the on-screen display, press AUDIO.

Rear of the player

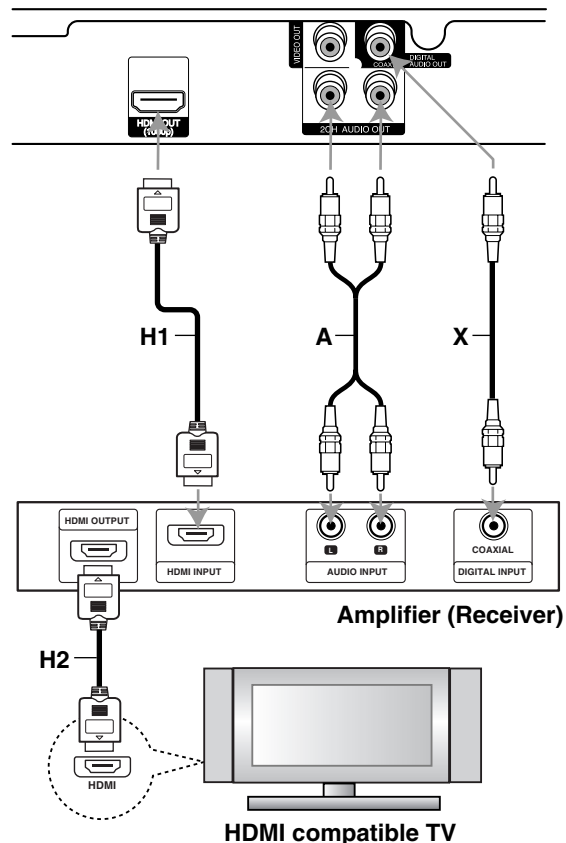

Resolution Setting

The player provides several output resolutions for HDMI OUT jack.

You can change the resolution using [Setup] menu or pressing the RESOLUTION button in stop mode.

Note:

Since several factors affect the resolution of video output, see "Available resolution according to the resolution setting" on this page.

Auto – If the HDMI OUT jack is connected for TVs providing display information (EDID), automatically selects the resolution best suited to the connected TV.

1080p – Outputs 1080 lines of progressive video.

1080i – Outputs 1080 lines of interlaced video.

720p – Outputs 720 lines of progressive video.

480p – Outputs 480 lines progressive video.

480i – Outputs 480 lines of interlaced video.

How to check the current resolution using RESOLUTION button

Press RESOLUTION button in stop mode. The current resolution appears in the display window (1080p, etc.) You can change the resolution also by pressing RESOLUTION button repeatedly.

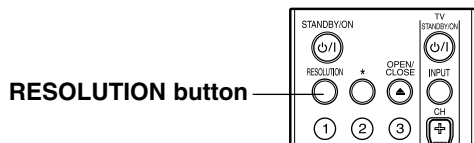

How to change the resolution using Setup menu

1. Press HOME and the Home Menu appears.
2. Select [Setup] and press ENTER. The Setup menu appears.
3. Use ▲ / ▼ to select [DISPLAY] option then press ► to move to the second level.
4. Use ▲ / ▼ to select the [Resolution] option then press ► to move to the third level.



5. Use ▲ / ▼ to select the desired resolution then press ENTER to confirm your selection.

Available resolution according to connection and media format

HDMI OUT connection

- For the 480i resolution setting, real output resolution of HDMI OUT will change to 480p.
- If you select a resolution manually and then connect the HDMI jack to TV and your TV does not accept it, the resolution setting is set to [Auto].
- If you select a resolution that your TV does not accept, the warning message will appear. After resolution change, if you cannot see the screen, please wait 20 seconds and the resolution will automatically revert back to the previous resolution.
- If the [1080p Display Mode] option is set to [24 Hz], the 1080p video output frame rate may be automatically set to either 24Hz or 60Hz depending both on the capability and preference of the connected TV and based on the native video frame rate of the content on the BD-ROM disc.

VIDEO OUT connection

The resolution of the VIDEO OUT jack is always outputted at 480i resolution.

Note:

Depending on your display, some of the resolution settings may result in the picture disappearing or an abnormal picture appearing. In this case, press HOME key then RESOLUTION repeatedly until the picture re-appear.

Available resolution according to the resolution setting

| Resolution Setting | HDMI OUT |
|--------------------|--------------|
| 480i | 480p |
| 480p | 480p |
| 720p | 720p |
| 1080i | 1080i |
| 1080p / 24Hz | 1080p / 24Hz |
| 1080p / 60Hz | 1080p / 60Hz |

Initial Settings

By using the Setup menu, you can make various adjustments to items such as picture and sound. You can also set a language for the subtitles and the Setup menu, among other things. For details on each Setup menu item, see pages 17 to 20.

To display and exit the Menu:

Press HOME and the Home Menu appears. Select [Setup] then press ENTER, and Setup menu appears.

Press RETURN or HOME to exit the Setup menu.

To go to the next level:

Press ► on the Remote Control.

To go back to the previous level:

Press ◀ on the Remote Control.

General Operation

1. Press HOME and the Home Menu appears.
2. Select [Setup] and press ENTER. The Setup menu appears.

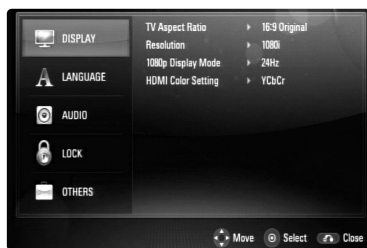

3. Use ▲ / ▼ to select the desired option then press ► to move to the second level. The screen shows the current setting for the selected item, as well as alternate setting(s).
4. Use ▲ / ▼ to select the second desired option then press ► to move to the third level.
5. Use ▲ / ▼ to select the desired setting then press ENTER to confirm your selection. Some items require additional steps.
6. Press RETURN or HOME to exit the Setup menu.

[DISPLAY] Menu

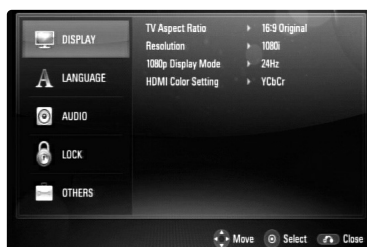

TV Aspect Ratio

[4:3 Letter Box] – Select when a standard 4:3 TV is connected. Displays theatrical images with masking bars above and below the picture.

[4:3 Pan Scan] – Select when a standard 4:3 TV is connected. Displays pictures cropped to fill your TV screen. Both sides of the picture are cut off.

[16:9 Original] – Select when a 16:9 wide TV is connected. The 4:3 picture is displayed with an original 4:3 aspect ratio, with black bars appearing at the left and right sides.

[16:9 Full] – Select when a 16:9 wide TV is connected. The 4:3 picture is adjusted horizontally (in a linear proportion) to fill the entire screen.

Resolution

Sets the output resolution of HDMI video signal. Refer to “Resolution Setting” on page 16 for details about the resolution.

1080p Display Mode

When the resolution is set to 1080p, select [24Hz] for smooth presentation of film material (1080p/24Hz) with an HDMI-equipped display compatible with 1080p/24Hz input.

Notes:

- When you select [24Hz], you may experience some picture disturbance when the video switches source and film material. In this case, select [60Hz].
- Even when [1080p Display Mode] is set to [24Hz], if your TV is not compatible with 1080p/24Hz, the actual frame frequency of the video output will be 60 Hz.
- If you want to set the 1080p/24Hz, set the resolution setting to [1080p] and [1080p Display Mode] option to [24Hz].

HDMI Color Setting

Select the type of output from the HDMI OUT jack. For this setting, please refer to the manuals of your display device.

[YCbCr] – Select when connecting to an HDMI display device.

[RGB] – Select when connecting to an DVI display device.

[LANGUAGE] Menu

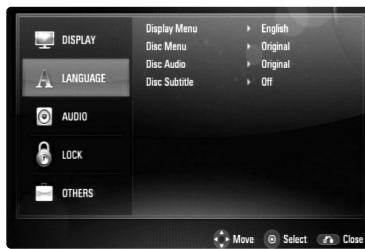

Display Menu

Select a language for the [Setup] menu and on-screen display.

Disc Menu / Disc Audio / Disc Subtitle

Select the language you prefer for the audio track (disc audio), subtitles, and the disc menu.

[Original] – Refers to the original language in which the disc was recorded.

[Other] – Press ENTER to select another language. Use number buttons then ENTER to enter the corresponding 4-digit number according to the language code list on page 29.

[Off] (for Disc Subtitle) – Turn off Subtitle.

Note:

Depending upon the disc, your language setting may not work for some discs.

[AUDIO] Menu

Each disc has a variety of audio output options. Set the player's Audio options according to the type of audio system you use.

Note:

Since many factors affect the type of audio output, see "The unit's Audio Output Specifications" on page 32 for details.

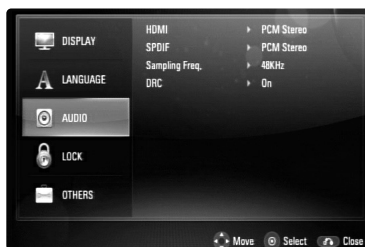

HDMI / SPDIF (Digital Audio Output)

Select the output sound format when a device equipped with an HDMI or Digital Audio input jack is connected to the HDMI OUT or DIGITAL AUDIO OUT jack on this player.

[PCM Stereo] – Select if you connect this unit's HDMI OUT or DIGITAL AUDIO OUT jack to a device with two-channel digital stereo decoder.

[PCM Multi-Ch] (HDMI only) – Select if you connect this unit's HDMI OUT jack to a device with multi-channel digital decoder.

[DTS Re-Encode] – Select if you connect this unit's HDMI OUT or DIGITAL AUDIO OUT jack to a device with DTS decoder.

[Primary Pass-Thru] – Select if you connect this unit's DIGITAL AUDIO OUT and HDMI OUT jack to a device with LPCM, Dolby Digital, Dolby Digital Plus, Dolby TrueHD, DTS and DTS-HD decoder.

Notes:

- When [HDMI] option is set to [PCM Multi-CH], the audio may output as PCM Stereo if the PCM Multi-Ch information is not detected from HDMI device with EDID.
- If the [HDMI] or [SPDIF] option is set to [DTS Re-Encode], the DTS Re-encode audio is outputted for BD-ROM discs with secondary audio and the original audio is outputted for the other discs (like [Primary Pass-Thru]).

Sampling Freq. (Only for SPDIF audio)

[192KHz] – Select this if your A/V Receiver or Amplifier is capable of handling 192 KHz signals.

[96KHz] – Select this if your A/V Receiver or Amplifier is NOT capable of handling 192 KHz signals. When this choice is made, this unit automatically converts any 192 KHz signals to 96 KHz so your system can decode them.

[48KHz] – Select this if your A/V Receiver or Amplifier is NOT capable of handling 192 KHz and 96 KHz signal. When this choice is made, this unit automatically converts any 192 KHz and 96 KHz signals to 48 KHz so your system can decode them.

Check the documentation for your A/V Receiver or Amplifier to verify its capabilities.

DRC (Dynamic Range Control)

When a disc encoded in Dolby Digital or Dolby Digital Plus is playing back, you may wish to compress the dynamic range of the audio output (the difference between the loudest sounds and the quietest ones). This allows you to listen to a movie at a lower volume without losing clarity of sound. Set DRC to [On] for this effect.

Note:

The DRC setting can be changed only when a disc is not inserted or the unit is in complete stop mode.

[LOCK] Menu (Parental Control)

Use the ▲ / ▼ / ◀ / ▶ buttons to select [LOCK] settings in the [Setup] menu.

The [LOCK] settings affect only BD and DVD playback. Set the password and have to input it to validate the [LOCK] settings.

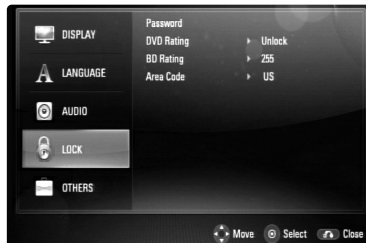

Password

You can create, change or delete the password.

1. Select [Password] option on the [LOCK] menu then press ▶.

2. Use number buttons on the remote control to input the 4-digit password.

To create new password, press ENTER when the [New] option is highlighted. Input new password and press ENTER. Enter it again and press ENTER to verify.

To change the password, press ENTER when the [Change] option is highlighted, then input old password and press ENTER. Input new password and press ENTER. Enter it again and press ENTER to verify.

To delete the password, select [Delete] option then press ENTER, then input password and press ENTER. The password is deleted.

Tip:

If you make a mistake before pressing ENTER, press CLEAR or ◀ to delete a number one by one.

If you forget your password

If you forget your password, you can clear it using the following steps:

1. Remove any disc that might be in the player.
2. Select [LOCK] → [Password] option in the [Setup] menu.
3. Use Number buttons to enter the 6-digit number "210499".
The password is cleared.

DVD Rating **DVD**

Blocks playback of rated disc based on their content. (Not all discs are rated.)

1. Select [DVD Rating] on the [LOCK] menu then press ▶.
2. To access this option, you must input the password you have created. If you have not yet entered password, you will be prompted to do so. Input a password and press ENTER. Enter it again and press ENTER to verify. If you make a mistake before pressing ENTER, press CLEAR or ◀ to delete a number one by one.
3. Select a rating from 1 to 8 using the ▲ / ▼ buttons.

[Rating 1-8] – Rating one (1) has the most restrictions and rating eight (8) is the least restrictive.

[Unlock] – If you select unlock, parental control is not active and the disc plays in full.

4. Press ENTER to confirm your rating selection.

BD Rating **BD**

Set an age limit for BD-ROM viewing.

1. Select [BD Rating] on the [LOCK] menu then press ▶.
2. Follow step 2 as shown above (DVD Rating).
3. Use number buttons to input an age limit for BD-ROM viewing.

[255 Year(s)] – All BD-ROM can be played.

[0-254 Year(s)] – Prohibits play of BD-ROM with corresponding ratings recorded on them.

4. Press ENTER to confirm your selection.

Area Code

Enter the code of the area whose standards were used to rate the DVD video disc, based on the list on page 29.

1. Select [Area Code] on the [LOCK] menu then press ▶.
2. Follow step 2 as shown above (DVD Rating).
3. Select an area code using ▲ / ▼ buttons then press ENTER to confirm your selection.

[OTHERS] Menu

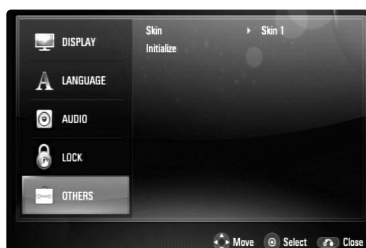

Skin

Changes the background of the initial screen.

Initialize

You can reset the player to its original factory settings or initialize the BD storage.

1. Select [Initialize] option then press ►.
2. Press ▲ / ▼ to select the desired option then press ENTER.
The confirm message will appear.

[Factory Set] – If you need to, you can reset the player to all its factory settings. Some options cannot be reset. (Rating, Password and Area Code, etc.)

[BD Storage Clear] – Deletes the BD contents from the connected USB Flash Drive. The files (such as music or photo file) stored in the USB Flash Drive except BD contents are not erased.

3. Use ◀ / ▶ to select [Yes] or [No] then press ENTER.

Operations

General playback features

1. Load your chosen disc in the tray, with the playback side down.
2. Start playback using the HOME menu (see page 10).

| Buttons | Operations | Discs |
|---|---|---|
| OPEN / CLOSE (▲) | Opens or closes the disc tray. | ALL |
| ▶ (PLAY) | Starts the playback. | ALL |
| ENTER | Acknowledges the selection on the menu screen (Disc menu, Title menu, POP-UP menu, etc.). | BD DVD |
| ■ (STOP) | Stops the playback. The unit records the stopped point, depending on the disc. "■" appears on the screen briefly. Press ▶ (PLAY) to resume playback (from the scene point). If you press ■ (STOP) on the remote control again or unload the disc ("■" appears on the screen.), the unit will clear the stopped point. (■ = Resume Stop, ■ = Complete Stop) | ALL BD DVD ACD MP3 WMA AVCHD |
| Notes: | | |
| <ul style="list-style-type: none"> • The resume point may be cleared when a button is pressed (for example; STANDBY/ON, OPEN/CLOSE, etc). • On BD-Video discs including BD-J, the resume play function does not work. • On BD-Video, DVD and AVCHD discs, if you press ■ (STOP) on the front panel in Resume Stop mode and [Movie] is highlighted on the [Home] menu, the unit will resume playback (from the scene point). • On BD-ROM interactive title, the unit will be in Complete Stop mode if you press ■ (STOP) once during playback. | | |
| ⏸ (PAUSE) | During playback, press ⏸ (PAUSE) to pause playback. Tip: During Audio CD or MP3/WMA playback, press ⏸ (PAUSE) once again to resume playback. Press ⏸ (PAUSE) repeatedly to play Frame-by-Frame. | ALL DVD BD AVCHD |
| ⏮ / ⏭ (SKIP) | During playback, press ⏮ or ⏭ to go to the next chapter/track/file or to return to the beginning of the current chapter/track/file. Press ⏮ twice briefly to step back to the previous chapter/track/file. | ALL |
| ⏪ / ⏩ (SCAN) | During playback, press SCAN (⏪ or ⏩) repeatedly to select the required scan speed. - DVD, BD, AVCHD: 5 steps, - Audio CD, MP3, WMA: 3 steps | ALL |
| | While the playback is paused, press SCAN ⏩ repeatedly to play in slow motion (4 steps, forward only). | DVD BD AVCHD |

Continued →

General playback features (Continued)

| Buttons | Operations | Discs |
|--------------|---|---|
| TITLE/POP-UP | If the current DVD or BD-ROM disc has a menu, the Title menu or Popup menu appears on the screen. Depending on the disc, the menu may not be available. | DVD BD AVCHD |
| DISC MENU | The menu appears on the screen. Depending on the disc, the menu may not be available. | DVD BD AVCHD |
| REPEAT | <p>Playing repeatedly: During playback, press REPEAT repeatedly to select a desired repeat mode. DVD, BD, AVCHD: Chapter/Title/Off Audio CD, MP3, WMA: Track/All/Off</p> <p>Note: If you press ►► once during Repeat Chapter/Track playback, the repeat playback cancels.</p> <p>Repeating a specific portion (A-B): During playback, press REPEAT to select [A-] at the beginning of the portion you wish to repeat and press ENTER at the end of the portion. To return to normal playback, press REPEAT repeatedly to select [Off].</p> <p>Note: You cannot select a portion less than 3 seconds.</p> <p>Playing in random order: During playback, press REPEAT repeatedly to select a Random (⌘) or Random All (⌘ All) mode icon. The tracks or files will be played in random order. To return to normal playback, press REPEAT repeatedly to delete the mode icons.</p> <p>Tip: When you are using the repeat, A-B repeat or random functions in the [MUSIC] menu, refer to the mode icons as shown below.</p> <ul style="list-style-type: none"> ⌘ Track – The current track or file will be played back repeatedly. ⌘ All – All the tracks or files will be played back repeatedly. ⌘ A-B – Selected portion will be repeated continually. (Audio CD only) ⌘ – The tracks or files will be played back in random order. ⌘ All – All the tracks or files will be played back repeatedly in random order. <p>To cancel the A-B repeat, repeat or Random playback, press CLEAR.</p> | <p>DVD BD ACD MP3 WMA AVCHD</p> <p>DVD BD ACD AVCHD</p> <p>ACD MP3 WMA</p> <p>ACD MP3 WMA</p> |

Continued →

General playback features (Continued)

| Buttons | Operations | Discs |
|-----------------|--|--------------|
| SUBTITLE | <p>During playback, press SUBTITLE repeatedly to select a desired subtitle language.</p> <p>Note: Some discs allow you to change subtitle selections only via the disc menu. If this is the case, press TITLE/POPUP or DISC MENU button and choose the appropriate subtitle from the selections on the disc menu.</p> | DVD BD AVCHD |
| SUBTITLE ON/OFF | <p>During playback, press SUBTITLE ON/OFF to switch the subtitle on or off.</p> | DVD BD AVCHD |
| AUDIO | <p>During playback, press AUDIO repeatedly to hear a different audio language or audio track.</p> <p>Notes:</p> <ul style="list-style-type: none"> Some discs allow you to change audio selections only via the disc menu. If this is the case, press TITLE/POPUP or DISC MENU button and choose the appropriate audio from the selections on the disc menu. Immediately after you have switched sound, there may be a temporary discrepancy between the display and actual sound. On BD-ROM disc, the multi audio format (5.1CH or 7.1CH) is displayed with [MultiCH] in the on-screen display. | DVD BD AVCHD |

Notes on general features:

- When you turn on the player or replace a disc, the player returns to the initial default setting. Depending on a disc, a specific type of audio the disc has is output.
- Depending on the pre-recorded contents of the BD-ROM, some functions may not be available or may be operated differently than other media.
- Some noise could be heard for a while when turning on the player. The noise is occurred by mechanical operations of the player but it is not a malfunction.

If a disc menu screen is displayed

DVD **BD** **AVCHD**

The menu screen may be displayed first after loading a disc which contains a menu.

Use ◀ / ▶ / ▲ / ▼ buttons to select the title/chapter you want to view, then press ENTER to start playback.

Enlarge the playback image

DVD **AVCHD** **BD**

1. During playback or pause mode, press ZOOM to display the [Zoom] menu.
2. Use green or yellow buttons to zoom in or out the picture. You can move through the zoomed picture using ▲ ▼ ◀ ▶ buttons.
3. To return to the normal picture size, press yellow button repeatedly to fully zoom out the picture. Press RETURN to exit the [Zoom] menu.

Note:

This function may not work on some disc or titles.

Time Search **DVD** **BD** **AVCHD**

To start playing at any chosen time on the disc:

1. Press DISPLAY during playback.
2. Press ▲ / ▼ to select the time clock icon and "--:--:--" appears.
3. Input the required start time in hours, minutes, and seconds from left to right. For example, to find a scene at 2 hours, 10 minutes, and 20 seconds, enter "21020" and press ENTER. If you enter the wrong numbers, press CLEAR to remove the numbers you entered. Then input the correct numbers.
4. Press ENTER to confirm. Playback starts from the selected time.

Note:

This function may not work on some disc or titles.

Skip Search **DVD** **BD** **AVCHD**

You can skip the playback 15 seconds forward or backward using the search menu.

1. During playback, press SEARCH and the search menu appears on the screen.
2. Press ◀ / ▶ to skip the playback forward or backward.

Tip:

You can select a point that you want to skip by pressing and holding ◀ / ▶ button.

Note:

This function may not work on some disc or titles.

Marker Search **DVD** **BD** **AVCHD**

To enter a Marker

You can start playback from up to nine memorized points. To enter a marker, press MARKER at the desired point on the disc. The Marker icon appears on the TV screen briefly. Repeat to enter up to nine markers.

To Recall or Clear a Marked Scene

1. Press SEARCH and the search menu appears on the screen.
2. Press a number button to select a marker number that you want to recall. Playback starts from the marked scene.

OR

Press ▼ to highlight a marker number. Use ◀ / ▶ to select a marked scene that you want to recall or clear.

Press ENTER and playback starts from the marked scene. Press CLEAR and the marked scene is erased from the search menu.

Notes:

- This function may not work on some disc or titles.
- All marked points are cleared if you press ■ (STOP) twice (complete stop), the title is changed or unload the disc.

Watching from a different angle

BD **DVD**

If the disc contains scenes recorded at different camera angles, you can change to a different camera angle during playback.

1. Press DISPLAY during playback.
2. Press ▲ / ▼ to select the angle icon then use ◀ ▶ to select desired angle.

Last Scene Memory **DVD** **BD**

This unit memorizes last scene from the last disc that is viewed. The last scene remains in memory even if you remove the disc from the unit or switch off the unit. If you load a disc that has the scene memorized, the scene is automatically recalled.

Notes:

- Settings are stored in memory for use any time.
- This unit does not memorize settings of a disc if you switch off the unit before commencing to play it.
- Last Scene Memory function for a previous disc is erased once a different disc is played.
- This function may not work depending on the disc.

Using Color (R, G, B, Y) Buttons **BD**

These buttons are available only during BD-J contents playback. Use the appropriate buttons as indicated by the display. Depending on the disc contents, the functions of each button may differ.

Screen Saver

The screen saver appears when you leave the player in Stop mode for about five minutes. If the Screen Saver is displayed for five minutes, the unit automatically turns itself off.

Changing content list view **MP3 WMA**

On the [MUSIC] and [PHOTO] menu, you can change the content list view by pressing DISPLAY repeatedly.

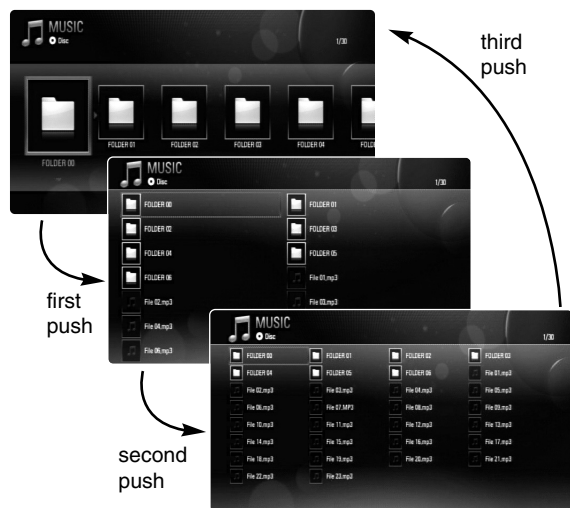

Note:

The equalizer will be disappeared when you change the music contents list view.

Displaying Disc Information On-Screen **DVD BD AVCHD**

You can display various information about the disc loaded on-screen.

1. Press DISPLAY to show various playback information.

The items displayed differ depending on the disc type or playing status.

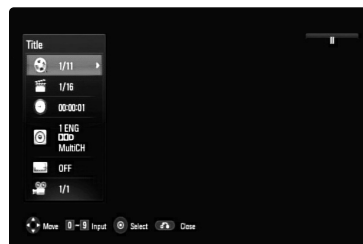

2. During BD-ROM or DVD playback, you can select an item by pressing ▲ / ▼ and change or select the setting by pressing ◀ / ▶.
 - Title/Track – Current title/track number/total number of titles/tracks.
 - Chapter – Current chapter number/total number of chapters.
 - Time – Elapsed playing time.
 - Audio – Selected audio language or channel.
 - Subtitle – Selected subtitle.
 - Angle – Selected angle/total number of angles.

Notes:

- If no button is pressed for a few seconds, the on-screen display disappears.
- A title number cannot be selected on some discs.
- An item may not be available on some discs or titles.
- If BD interactive title is playing back, some setting information is displayed on the screen but prohibited to be changed.

Playing a DVD VR Format Disc

This unit will play DVD-RW disc that is recorded using the Video Recording (VR) format.

1. Insert a disc and close the tray.
The [MOVIE] menu appears on the TV screen.



2. Press ◀ / ▶ to select a title then press ▶ (PLAY) and playback starts.
You can use variable playback functions.
Refer to pages 21-25.
3. Press DISC MENU to move to the list menu.

Notes:

- On the [MOVIE] menu, use red or blue button to move to the first or the last file or track and green or yellow button to move to the previous or next page.
- Unfinalized DVD-VR format discs may not be played in this player.
- Some DVD-VR disc are made with CPRM data by DVD RECORDER. This unit cannot support these kinds of discs.

What is CPRM?

CPRM is a copy protection system (with scramble system) only allowing the recording of 'copy once' broadcast programs. CPRM stands for Content Protection for Recordable Media.

Playing an Audio CD or MP3/WMA files **ACD** **MP3** **WMA**

The player can play Audio CDs and MP3/WMA files. Before playing MP3/WMA files, read "MP3/WMA audio file requirement" on right.

1. Insert Audio CD or a disc containing MP3/WMA files, or connect the USB Flash Drive containing MP3/WMA files
2. Press HOME and Home Menu appears.
3. Select [Music] then press ENTER.
The [MUSIC] menu appears on the TV screen.

Note:

When the USB Flash Drive is connected and a disc is inserted simultaneously, the menu for selecting a media will appear. Select a media then press ENTER.

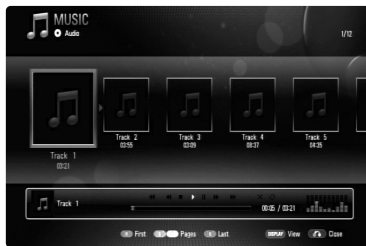

Example) Audio CD

4. Use ▲ / ▼ / ◀ / ▶ to select a track or file then press ► (PLAY). Playback starts.
You can use variable playback functions. Refer to pages 21-25.
5. To stop playback at any time, press ■ (STOP).

Tips:

- To go directly to any track or file and play, enter the track/file number using the numbered buttons (0-9).
- The playback may start automatically if the Audio CD inserted.
- Use ▲/▼/◀/▶ to select a folder then press ENTER and you can view the files in the folder. If you want to move to the upper or lower directory, use ▲/▼ to move to the desired directory.
- On the [MUSIC] menu, use red or blue button to move to the first or the last file or track and green or yellow button to move to the previous or next page.
- The equalizer indicator is not coupled with the music in play back.
- If there is impossible code to express in the file name, it may be displayed as illegible.

MP3/WMA audio file requirement

File extensions: ".mp3", ".wma"

Sampling frequency: within 11 - 48 kHz (MP3), within 8 - 48 kHz (WMA)

Bit rate: within 8 - 320 kbps (MP3, WMA)

CD-R/RW, DVD-R/RW, +R/+RW, BD-R/RE Format: ISO 9660+JOLIET, UDF and UDF Bridge format

Maximum Files/Folder:

Less than 2,000 (total number of files and folders)

Notes on MP3/WMA file

- Depending on the size and number of the MP3/WMA files, it may take several minutes to read the contents of the media.
- This unit cannot support the ID3 Tag embedded in the MP3 file.
- The total playback time indicated on the screen may not correct for VBR files.

Viewing a Photo file **PHOTO**

This unit can play photo files. Before playing photo files, read "Photo file requirement" on below.

1. Insert a disc containing photo files, or connect the USB Flash Drive containing photo files.
2. Press HOME and Home Menu appears.
3. Select [Photo] then press ENTER.
The [PHOTO] menu appears on the TV screen.

Note:

When the USB Flash Drive is connected and a disc is inserted simultaneously, the menu for selecting a media will appear. Select a media then press ENTER.

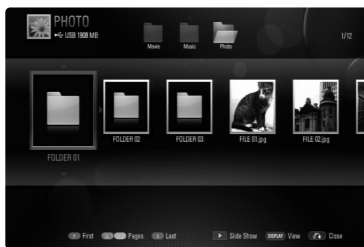

4. Use ▲/▼/◀/▶ to select a file and press ENTER.
The selected image is displayed in full screen.



5. To stop viewing at any time, press ■ (STOP).
The PHOTO menu appears.

Tips:

- To go directly to any file and play, enter the file number using the numbered buttons (0-9).
- Use ▲/▼/◀/▶ to select a folder then press ENTER and you can view the files in the folder. If you want to move to the upper or lower directory, use ▲/▼ to move to the desired directory.
- On the [MUSIC] menu, use red or blue button to move to the first or the last file or track and green or yellow button to move to the previous or next page.
- If there is impossible code to express in the file name, it may be displayed as illegible.
- You can change the content list view by pressing DISPLAY repeatedly.
- You can start the slide show by pressing ▶ (PLAY) while the [PHOTO] menu appears. To start the slide show, choose the folder containing photo files or the photo file then press ▶ (PLAY).

Options during viewing a photo file in full screen

You can use various options during viewing a picture in full screen. Use ▲▼◀▶ to select an option and use the options as described below.

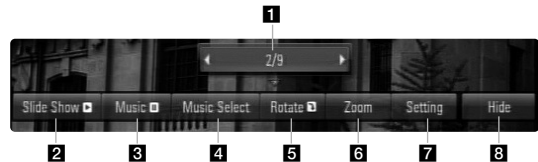

- 1 Use ◀▶ to advance to the previous or next file.
- 2 Press ENTER to start or pause the slide show.
- 3 Press ENTER to play or pause the background music. This option is available after the background music is selected using [Music Select] option.
- 4 Selects the background music.
 - 1) Press ENTER and the menu will appear.
 - 2) Use ▲▼◀▶ to select a media or folder that there are music file(s).
 - 3) Press ENTER to confirm your selection.
- 5 Press ENTER to rotate the picture clockwise. This option is not available during slide show.
- 6 Use green or yellow buttons to zoom in or out the picture. You can move through the zoomed picture using ▲▼◀▶ buttons. Press RETURN to exit the [Zoom] menu and return to the normal picture size.
 - The zoom function can be operated by the ZOOM button on the remote control.
- 7 Use ▲▼ to selects an option between [Effect] or [Delay].
Use ◀▶ to adjusts and press ENTER to set the selected option.

[Effects] – You can apply various effects when sliding photos.

 - OFF: Slide Show without any effect.
 - Random: Slide show effects are applied randomly.
 - Slide: Slides a photo from various direction.
 - Door: Photo will be appear like door opening.
 - Lattice: Photo will be appear from tiled pieces to full screen image

[Delay] – You can set the photo delaying time while Slide Show.
- 8 Press ENTER to exit the option menu.
To appear the menu again, press ENTER.

Photo file requirement

File extensions: ".jpg", ".jpeg", ".png"

Recommended size:

Less than 4,000 x 3,000 x 24 bit/pixel

Less than 3,000 x 3,000 x 32 bit/pixel

CD-R/RW, DVD-R/RW, +R/+RW, BD-R/RE Format:

ISO 9660+JOLIET, UDF and UDF Bridge format

Maximum Files/Folder:

Less than 2,000 (total number of files and folders)

Notes on Photo file

- Progressive and lossless compression photo image files are not supported.
- Depending on the size and number of the photo files, it may take several minutes to read the contents of the media.

Reference

Language Codes

Use this list to input your desired language for the following initial settings: [Disc Audio], [Disc Subtitle] and [Disc Menu].

| Language | Code | Language | Code | Language | Code | Language | Code |
|-----------------|------|------------------|------|----------------|------|------------|------|
| Abkhazian | 6566 | Fiji | 7074 | Lingala | 7678 | Singhalese | 8373 |
| Afar | 6565 | Finnish | 7073 | Lithuanian | 7684 | Slovak | 8375 |
| Afrikaans | 6570 | French | 7082 | Macedonian | 7775 | Slovenian | 8376 |
| Albanian | 8381 | Frisian | 7089 | Malagasy | 7771 | Somali | 8379 |
| Ameharic | 6577 | Galician | 7176 | Malay | 7783 | Spanish | 6983 |
| Arabic | 6582 | Georgian | 7565 | Malayalam | 7776 | Sudanese | 8385 |
| Armenian | 7289 | German | 6869 | Maltese | 7784 | Swahili | 8387 |
| Assamese | 6583 | Greek | 6976 | Maori | 7773 | Swedish | 8386 |
| Aymara | 6589 | Greenlandic | 7576 | Marathi | 7782 | Tagalog | 8476 |
| Azerbaijani | 6590 | Guarani | 7178 | Moldavian | 7779 | Tajik | 8471 |
| Bashkir | 6665 | Gujarati | 7185 | Mongolian | 7778 | Tamil | 8465 |
| Basque | 6985 | Hausa | 7265 | Nauru | 7865 | Tatar | 8484 |
| Bengali; Bangla | 6678 | Hebrew | 7387 | Nepali | 7869 | Telugu | 8469 |
| Bhutani | 6890 | Hindi | 7273 | Norwegian | 7879 | Thai | 8472 |
| Bihari | 6672 | Hungarian | 7285 | Oriya | 7982 | Tibetan | 6679 |
| Breton | 6682 | Icelandic | 7383 | Panjabi | 8065 | Tigrinya | 8473 |
| Bulgarian | 6671 | Indonesian | 7378 | Pashto, Pushto | 8083 | Tonga | 8479 |
| Burmese | 7789 | Interlingua | 7365 | Persian | 7065 | Turkish | 8482 |
| Byelorussian | 6669 | Irish | 7165 | Polish | 8076 | Turkmen | 8475 |
| Cambodian | 7577 | Italian | 7384 | Portuguese | 8084 | Twi | 8487 |
| Catalan | 6765 | Japanese | 7465 | Quechua | 8185 | Ukrainian | 8575 |
| Chinese | 9072 | Javanese | 7487 | Rhaeto-Romance | 8277 | Urdu | 8582 |
| Corsican | 6779 | Kannada | 7578 | Rumanian | 8279 | Uzbek | 8590 |
| Croatian | 7282 | Kashmiri | 7583 | Russian | 8285 | Vietnamese | 8673 |
| Czech | 6783 | Kazakh | 7575 | Samoan | 8377 | Volapük | 8679 |
| Danish | 6865 | Kirghiz | 7589 | Sanskrit | 8365 | Welsh | 6789 |
| Dutch | 7876 | Korean | 7579 | Scots Gaelic | 7168 | Wolof | 8779 |
| English | 6978 | Kurdish | 7585 | Serbian | 8382 | Xhosa | 8872 |
| Esperanto | 6979 | Laothian | 7679 | Serbo-Croatian | 8372 | Yiddish | 7473 |
| Estonian | 6984 | Latin | 7665 | Shona | 8378 | Yoruba | 8979 |
| Faroese | 7079 | Latvian, Lettish | 7686 | Sindhi | 8368 | Zulu | 9085 |

Area Codes

Choose an Area code from this list.

| Area | Code | Area | Code | Area | Code | Area | Code |
|----------------|------|---------------------------|------|----------------------|------|-----------------|------|
| Afghanistan | AF | Ethiopia | ET | Malaysia | MY | Saudi Arabia | SA |
| Argentina | AR | Fiji | FJ | Maldives | MV | Senegal | SN |
| Australia | AU | Finland | FI | Mexico | MX | Singapore | SG |
| Austria | AT | France | FR | Monaco | MC | Slovak Republic | SK |
| Belgium | BE | Germany | DE | Mongolia | MN | Slovenia | SI |
| Bhutan | BT | Great Britain | GB | Morocco | MA | South Africa | ZA |
| Bolivia | BO | Greece | GR | Nepal | NP | South Korea | KR |
| Brazil | BR | Greenland | GL | Netherlands | NL | Spain | ES |
| Cambodia | KH | Herd and Mcdonald Islands | HM | Netherlands Antilles | AN | Sri Lanka | LK |
| Canada | CA | Hong Kong | HK | New Zealand | NZ | Sweden | SE |
| Chile | CL | Hungary | HU | Nigeria | NG | Switzerland | CH |
| China | CN | India | IN | Norway | NO | Taiwan | TW |
| Colombia | CO | Indonesia | ID | Oman | OM | Thailand | TH |
| Congo | CG | Israel | IL | Pakistan | PK | Turkey | TR |
| Costa Rica | CR | Italy | IT | Panama | PA | Uganda | UG |
| Croatia | HR | Jamaica | JM | Paraguay | PY | Ukraine | UA |
| Czech Republic | CZ | Japan | JP | Philippines | PH | United States | US |
| Denmark | DK | Kenya | KE | Poland | PL | Uruguay | UY |
| Ecuador | EC | Kuwait | KW | Portugal | PT | Uzbekistan | UZ |
| Egypt | EG | Libya | LY | Romania | RO | Vietnam | VN |
| El Salvador | SV | Luxembourg | LU | Russian Federation | RU | Zimbabwe | ZW |

Troubleshooting

| Symptom | Possible Cause | Correction |
|--|--|---|
| No power. | <ul style="list-style-type: none"> The power cord is disconnected. | <ul style="list-style-type: none"> Plug the power cord into the wall outlet securely. |
| The power is on, but the player does not work. | <ul style="list-style-type: none"> No disc is inserted. | <ul style="list-style-type: none"> Insert a disc. |
| No picture. | <ul style="list-style-type: none"> The TV is not set to receive video signal output. | <ul style="list-style-type: none"> Select the appropriate video input mode on the TV. |
| | <ul style="list-style-type: none"> The video cable is not connected securely. | <ul style="list-style-type: none"> Connect the video cable securely. |
| | <ul style="list-style-type: none"> The selected resolution is not capable with your TV. | <ul style="list-style-type: none"> Select another resolution using RESOLUTION button. |
| No sound. | <ul style="list-style-type: none"> The equipment connected with the audio cable is not set to receive disc signal output. | <ul style="list-style-type: none"> Select the correct input mode of the audio receiver so you can listen to the sound from the player. |
| | <ul style="list-style-type: none"> The power of the equipment connected with the audio cable is turned off. | <ul style="list-style-type: none"> Turn on the equipment connected with the audio cable. |
| | <ul style="list-style-type: none"> The [AUDIO] options are set to the wrong position. | <ul style="list-style-type: none"> Set the [AUDIO] options to the correct position (see page 18). |
| | <ul style="list-style-type: none"> The player is in reverse play, fast forward, slow motion or pause mode. | <ul style="list-style-type: none"> Return to the normal playback. |
| The player does not start playback. | <ul style="list-style-type: none"> The disc is upside down. | <ul style="list-style-type: none"> Insert the disc with the playback side down. |
| | <ul style="list-style-type: none"> An unplayable disc is inserted. | <ul style="list-style-type: none"> Insert a playable disc. (Check the disc type and regional code.) |
| | <ul style="list-style-type: none"> The rating level is set. | <ul style="list-style-type: none"> Change the rating level. |
| | <ul style="list-style-type: none"> The disc was recorded on another unit and was not finalized. | <ul style="list-style-type: none"> Finalize the disc on that unit. |
| The Remote Control does not work properly. | <ul style="list-style-type: none"> The Remote Control is not pointed at the remote sensor on the player. | <ul style="list-style-type: none"> Point the Remote Control at the remote sensor of the player. |
| | <ul style="list-style-type: none"> The Remote Control is too far from the player. | <ul style="list-style-type: none"> Operate the Remote Control closer to the player. |
| The system does not function at all. | <ul style="list-style-type: none"> A state is unstable. | <ul style="list-style-type: none"> Unplug the power cord and then plug the power cord again after more than five seconds. |

Specifications

General

| | |
|--------------------------------|--|
| Power requirements: | AC 120 V~, 60 Hz |
| Power consumption: | 23W |
| Dimensions (W x H x D): | Approx. 16.9 x 1.4 x 7.9 inches (430 x 35 x 200 mm) without foot |
| Net Weight (Approx.): | 4.6 lbs (2.1 kg) |
| Operating temperature: | 41 °F to 95 °F (5 °C to 35 °C) |
| Operating humidity: | 5 % to 90 % |

Outputs

| | |
|--------------------------------|--|
| VIDEO OUT: | 1.0 V (p-p), 75 Ω, sync negative, RCA jack x 1 |
| HDMI OUT (video/audio): | 19 pin (HDMI standard, Type A) |
| ANALOG AUDIO OUT: | 2.0 Vrms (1 kHz, 0 dB), 600 Ω, RCA jack (L, R) x 1 |
| DIGITAL OUT (COAXIAL): | 0.5 V (p-p), 75 Ω, RCA jack x 1 |

System

| | |
|-------------------------------|---|
| Laser: | Semiconductor laser, wavelength: 405nm / 650 nm |
| Signal system: | Standard NTSC Color TV system |
| Frequency response: | 20 Hz to 20 kHz (48 kHz, 96 kHz, 192 kHz sampling) |
| Signal-to-noise ratio: | More than 100 dB (ANALOG OUT connectors only) |
| Harmonic distortion: | Less than 0.008% |
| Dynamic range: | More than 95 dB |
| Bus power supply: | DC 5 V $\bar{\bar{=}}$ 500 mA |
| Accessories: | Video cable (1) Audio cable (1) Remote control (1) Batteries (1) |

Note: Design and specifications are subject to change without prior notice.

The unit's Audio Output Specifications

| Source \ Jack/ Setting | Analog Output Stereo | SPDIF (DIGITAL AUDIO OUT)*5 | | |
|---------------------------|-------------------------|-----------------------------|------------------------|------------------------|
| | | PCM Stereo | DTS Re-encode*3, *6 | Primary Pass-Thru*1 |
| Dolby Digital | PCM 2ch | PCM 2ch | DTS | Dolby Digital |
| Dolby Digital Plus | PCM 2ch | PCM 2ch | DTS | Dolby Digital |
| Dolby TrueHD | PCM 2ch | PCM 2ch | DTS | Dolby Digital |
| DTS | PCM 2ch | PCM 2ch | DTS | DTS |
| DTS-HD | PCM 2ch | PCM 2ch | DTS | DTS |
| Linear PCM 2ch | PCM 2ch | PCM 2ch | DTS | PCM 2ch |
| Linear PCM 5.1ch | PCM 2ch | PCM 2ch | DTS | PCM 2ch |
| Linear PCM 7.1ch | PCM 2ch | PCM 2ch | DTS | PCM 2ch |

| Source \ Jack/ Setting | HDMI OUT | | | |
|---------------------------|---------------|-------------------|--------------------|---------------------------------|
| | PCM Stereo | PCM Multi-Ch*3 | DTS Re-encode*6 | Primary Pass-Thru *1, *2, *3 |
| Dolby Digital | PCM 2ch | PCM 5.1ch | DTS | Dolby Digital |
| Dolby Digital Plus | PCM 2ch | PCM 7.1ch | DTS | Dolby Digital Plus |
| Dolby TrueHD | PCM 2ch | PCM 7.1ch | DTS | Dolby TrueHD |
| DTS | PCM 2ch | PCM 5.1ch | DTS | DTS |
| DTS-HD | PCM 2ch | PCM 7.1ch | DTS | DTS-HD |
| Linear PCM 2ch | PCM 2ch | PCM 2ch | DTS | PCM 2ch |
| Linear PCM 5.1ch | PCM 2ch | PCM 5.1ch | DTS | PCM 5.1ch |
| Linear PCM 7.1ch | PCM 2ch | PCM 7.1ch | DTS | PCM 7.1ch*4 |

Notes:

- *1 The secondary and interactive audio may not be included in the output bitstream if [SPDIF] or [HDMI] option is set to [Primary Pass-Thru]. (Except LPCM Codec : the output always include interactive and secondary audio.)
- *2 This player automatically selects the HDMI audio according to the decoding capability of the connected HDMI device even though [HDMI] option is set to [Primary Pass-Thru].
- *3 The [PCM Multi-CH]/[Primary Pass-Thru] setting of the [HDMI] option and [DTS Re-Encode] setting of the [SPDIF] option cannot be set together. If you set the [HDMI] option to [PCM Multi-CH] or [Primary Pass-Thru], the [SPDIF] option is set to [PCM Stereo] automatically. Also, if you set the [SPDIF] option to [DTS Re-Encode], the [HDMI] option is set to [PCM Stereo] automatically.
- *4 The LPCM audio recorded at 192kHz sampling frequency will be outputted as stereo sound.
- *5 On the PCM audio output, the sampling frequency of SPDIF (DIGITAL AUDIO OUT) is limited to 96 kHz.
- *6 If the [HDMI] or [SPDIF] option is set to [DTS Re-Encode], the audio output is limited to 48 kHz and 5.1 ch. If the [HDMI] or [SPDIF] option is set to [DTS Re-Encode], the DTS Re-Encode audio is outputted for BD-ROM discs, and the original audio is outputted for the other discs (like [Primary Pass-Thru]).
- If [HDMI] option is set to [PCM Multi-CH] and [SPDIF] option is set to [Primary Pass-Thru] when the unit plays back Dolby Digital Plus or TrueHD audio, SPDIF (DIGITAL AUDIO OUT) jack is limited to "PCM 2ch".
- If the HDMI connection is version 1.3 and Dolby Digital Plus/Dolby TrueHD is outputted from HDMI OUT jack, SPDIF (DIGITAL AUDIO OUT) jack is limited to "PCM 2ch" (When the HDMI and SPDIF are connected simultaneously).
- The audio is outputted as PCM 48 kHz/16 bit for MP3/WMA file and PCM 44.1kHz/16 bit for Audio CD while playback.
- The Dolby TrueHD audio recorded on some Blu-ray discs consists of Dolby Digital and TrueHD audio. Dolby Digital audio is output through DIGITAL AUDIO OUT jacks and "DD" displays on the screen if TrueHD audio is not output (for example, when [HDMI] is set to [PCM Stereo] and [SPDIF] is set to [Primary Pass-Thru]).
- The analog 2 channel output connection is always output PCM 2CH sound.

Open source software notice

This product includes

- Freetype library : copyright © 2003 The FreeType Project (www.freetype.org).
- libpng library : copyright © 2004 Glenn Randers-Pehrson
- Zlib compression library: Copyright © 1995-2002 Jean-loup Gailly and Mark Adler.
- Expat library : copyright © 2006 expat maintainers.
- OpenSSL library :
 - cryptographic software written by Eric Young (ey@cryptsoft.com).
 - software written by Tim Hudson (tjh@cryptsoft.com).
 - software developed by the OpenSSL Project for use in the OpenSSL Toolkit. (<http://www.openssl.org>)
- libcurl library : Copyright © 1996 - 2008, Daniel Stenberg, daniel@haxx.se
- boost C++ library : © Copyright Beman Dawes 1999-2003
- UPnP SDK : Copyright © 2000-2003 Intel Corporation
- Libnet : © 1998 - 2004 Mike D. Schiffman mike@infonexus.com
- Libpcap

This product includes other open source software.

- Copyright © David L. Mills 1992-2006
- Copyright © 1998-2003 Daniel Veillard.
- Copyright © 1998, 1999 Thai Open Source Software Center Ltd.
- Copyright © 1990 The Regents of the University of California.
- Copyright © 1998-2005 The OpenSSL Project.
- Copyright © 1991, 1992 Paul Kranenburg <pk@cs.few.eur.nl>
- Copyright © 1993 Branko Lankester <branko@hacktic.nl>
- Copyright © 1993 Ulrich Pegelow <pegelow@moorea.uni-muenster.de>
- Copyright © 1995, 1996 Michael Elizabeth Chastain <mec@duracef.shout.net>
- Copyright © 1993, 1994, 1995, 1996 Rick Sladkey <jrs@world.std.com>
- Copyright © 1999,2000 Wichert Akkerman <wakkerma@debian.org>

All rights reserved.

Permission is hereby granted, free of charge, to any person obtaining a copy of this software and associated documentation files (the "Software"), to deal in the Software without restriction, including without limitation the rights to use, copy, modify, merge, publish, distribute, sublicense, and/or sell copies of the Software, and to permit persons to whom the Software is furnished to do so, subject to the following conditions:

THE SOFTWARE IS PROVIDED "AS IS", WITHOUT WARRANTY OF ANY KIND, EXPRESS OR IMPLIED, INCLUDING BUT NOT LIMITED TO THE WARRANTIES OF MERCHANTABILITY, FITNESS FOR A PARTICULAR PURPOSE AND NONINFRINGEMENT. IN NO EVENT SHALL THE AUTHORS OR COPYRIGHT HOLDERS BE LIABLE FOR ANY CLAIM, DAMAGES OR OTHER LIABILITY, WHETHER IN AN ACTION OF CONTRACT, TORT OR OTHERWISE, ARISING FROM, OUT OF OR IN CONNECTION WITH THE SOFTWARE OR THE USE OR OTHER DEALINGS IN THE SOFTWARE.



LIMITED WARRANTY

USA ONLY

ONLY FOR PRODUCT PURCHASED IN U.S.A.

CONSUMER VIDEO 1-90

JVC COMPANY OF AMERICA (JVC) warrants this product and all parts thereof, except as set forth below ONLY TO THE ORIGINAL RETAIL PURCHASER to be FREE FROM DEFECTIVE MATERIALS AND WORKMANSHIP from the date of original purchase for the period shown below. ("The Warranty Period")

| | | | |
|-------|-------------|-------|----------------|
| PARTS | 1 YR | LABOR | 90 DAYS |
|-------|-------------|-------|----------------|

THIS LIMITED WARRANTY IS VALID ONLY IN THE FIFTY (50) UNITED STATES, THE DISTRICT OF COLUMBIA AND IN THE COMMONWEALTH OF PUERTO RICO.

WHAT WE WILL DO:

If this product is found to be defective within the warranty period, JVC will repair or replace defective parts with new or rebuilt equivalents at no charge to the original owner. Such repair and replacement services shall be rendered by JVC during normal business hours at JVC authorized service centers. Parts used for replacement are warranted only for the remainder of the Warranty Period. All products may be brought to a JVC authorized service center on a carry-in basis. Color televisions with a screen size of 27" or greater qualify for in-home service. In such cases, a technician will come to your home and either repair the TV there or remove and return it if it cannot be repaired in your home.

WHAT YOU MUST DO FOR WARRANTY SERVICE:

Please do not return your product to the retailer
Instead, return your product to the JVC authorized service center nearest you. If shipping the product to the service center, please be sure to package it carefully, preferably in the original packaging, and include a brief description of the problem(s). Please call 1-800-252-5722 to locate the nearest JVC authorized service center. Service locations can also be obtained from our website <http://www.jvc.com>. If your product qualifies for in-home service, the service representative will require clear access to the product.

If you have any questions concerning your JVC Product, please contact our Customer Relations Department at 800-252-5722

WHAT IS NOT COVERED:

- This limited warranty provided by JVC does not cover:
1. Products which have been subject to abuse, accident, alteration, modification, tampering, negligence, misuse, faulty installation, lack of reasonable care, or if repaired or serviced by anyone other than a service facility authorized by JVC to render such service, or if affixed to any attachment not provided with the products, or if the model or serial number has been altered, tampered with, defaced or removed;
 2. Initial installation, installation and removal from cabinets or mounting systems.
 3. Operational adjustments covered in the Owner's Manual, normal maintenance, video and audio head cleaning;
 4. Damage that occurs in shipment, due to act of God, and cosmetic damage;
 5. Signal reception problems and failures due to line power surge;
 6. User Removal Memory Devices/Video Pick-up Tubes/CCD Image Sensors are covered for 90days from the date of purchase;
 7. Accessories;
 8. Batteries (except that Rechargeable Batteries are covered for 90 days from the date of purchase);
 9. Products used for commercial purposes, including, but not limited to rental.
 10. Loss of data resultant from malfunction of hard drive or other data storage device.

There are no express warranties except as listed above.

THE DURATION OF ANY IMPLIED WARRANTIES, INCLUDING THE IMPLIED WARRANTY OF MERCHANTABILITY, IS LIMITED TO THE DURATION OF THE EXPRESS WARRANTY HEREIN.

JVC SHALL NOT BE LIABLE FOR ANY LOSS OF USE OF THE PRODUCT, INCONVIENCE, OR ANY OTHER DAMAGES, WHETHER DIRECT, INCIDENTAL OR CONSEQUENTIAL (INCLUDING, WITHOUT LIMITATION, DAMAGE TO TAPES, RECORDS OR DISCS) RESULTING FROM THE USE OF THIS PRODUCT, OR ARISING OUT OF ANY BREACH OF THIS WARRANTY. ALL EXPRESS AND IMPLIED WARRANTIES, INCLUDING THE WARRANTIES OF MERCHANTABILITY AND FITNESS FOR PARTICULAR PURPOSE, ARE LIMITED TO THE WARRANTY PERIOD SET FORTH ABOVE.

Some states do not allow the exclusion of incidental or consequential damages or limitations on how long an implied warranty lasts, so these limitations or exclusions may not apply to you. This warranty gives you specific legal rights and you may also have other rights which vary from state to state.

JVC COMPANY OF AMERICA 1700 Valley Road
 DIVISION OF JVC AMERICAS CORP. Wayne, NJ 07470
<http://www.jvc.com>

REFURBISHED PRODUCTS CARRY A SEPARATE WARRANTY, THIS WARRANTY DOES NOT APPLY. FOR DETAIL OF REFURBISHED PRODUCT WARRANTY, PLEASE REFER TO THE REFURBISHED PRODUCT WARRANTY INFORMATION PACKAGED WITH EACH REFURBISHED PRODUCT.

For customer use:

Enter below the Model No. and Serial No. which is located either on the rear, bottom or side of the cabinet. Retain this information for future reference.

| | |
|-----------------|------------------|
| Model No. : | Serial No. : |
| Purchase date : | Name of dealer : |

FOR SERVICING (Only in U.S.A.)

TO OUR VALUED CUSTOMER

THANK YOU FOR PURCHASING THIS JVC PRODUCT.
WE WANT TO HELP YOU ACHIEVE A PERFECT EXPERIENCE.

**NEED HELP ON HOW TO HOOK UP?
NEED ASSISTANCE ON HOW TO OPERATE?
NEED TO LOCATE A JVC SERVICE CENTER?
LIKE TO PURCHASE ACCESSORIES?**

XV-BP10 / XV-BP11

JVC[®] IS HERE TO HELP!
TOLL FREE: 1(800)252-5722
<http://www.jvc.com>

Remember to retain your Bill of Sale for Warranty Service.

Do not attempt to service the product yourself

Caution

To prevent electrical shock, do not open the cabinet.
There are no user serviceable parts inside.
Please refer to qualified service personnel for repairs.

BT-51005-9
(0904)

JVC

EN

© 2009 Victor Company of Japan, Limited

0809SKMLGEEGL
P/N: MFL62026484

Free Manuals Download Website

<http://myh66.com>

<http://usermanuals.us>

<http://www.somanuals.com>

<http://www.4manuals.cc>

<http://www.manual-lib.com>

<http://www.404manual.com>

<http://www.luxmanual.com>

<http://aubethermostatmanual.com>

Golf course search by state

<http://golfingnear.com>

Email search by domain

<http://emailbydomain.com>

Auto manuals search

<http://auto.somanuals.com>

TV manuals search

<http://tv.somanuals.com>