

VM9512

Installation and Operation Manual



240

Watts Peak
Watts en Crête
Vatios el Máximo
60W x 4

CONTENTS

Thank you for choosing a Jensen product. We hope you will find the instructions in this owner's manual clear and easy to follow. If you take a few minutes to look through it, you'll learn how to use all the features of your new Jensen VM9512 Mobile Multimedia Receiver for maximum enjoyment.

Preparation.....	1
Installation	5
Anti-Theft Feature	6
Controls and Indicators	7
Remote Control	9
Using the TFT Monitor	12
Operating Instructions	14
Multi-ZONE Operation.....	15
Setup Menu	16
Tuner Operation	18
Satellite Radio Operation	20
DVD/VCD Video Operation	22
DVD/CD Audio Operation	25
MP3/WMA/iPod Operation	26
Troubleshooting	29
Specifications	32

PREPARATION

Congratulations on your purchase of the Jensen VM9512 Mobile Multimedia Receiver.

It's a good idea to read all of the instructions before beginning the installation. We recommend having your Jensen VM9512 installed by a reputable installation shop.

Features

DVD

- Aspect Ratio - Cinema, Normal and OFF (Standby)
- Fast Forward, Fast Reverse - 2X, 4X and 8X
- Slow Forward, Slow Reverse - 2X, 4X and 8X
- Play, Pause, Stop, Next Chapter and Previous Chapter
- ESP - 2MB Buffer

CD / MP3 / WMA

- ID3 Tag Compatible
- Directory Search (MP3 / WMA Only)
- Direct Track Access via Remote control
- Burn Up To 1500 MP3 and WMA Files onto a DVD+R / RW
- Audible Forward / Reverse Track Search
- Random, Repeat and Intro
- Play, Pause, Stop, Next Track and Previous Track
- ESP - 2MB Buffer

AM-FM

- USA/Europe/Latin America/Asia Frequency Spacing
- 30 Station Presets (18 FM, 12 AM)
- Auto Stereo/Mono
- Local/Distance
- Auto Store/Preview Scan
- RDS (Radio Data System)

Sat Radio Ready

- Compatible with XM and Sirius Tuners (Sold Separately)
- Requires XMDJEN100 or JXMC Cables (Sold Separately)
- Satellite Channel Name, Artist, Song and Categories Displayed on TFT Screen

iPod

- **jLinkDirect** - High Speed Direct Connect Interface to Access iPod Playlists, Artists, Albums, Songs, **Photos and **Video (** Requires Photo or Video iPod)
- Power Management Charges iPod while Connected
- Requires jLinkCable iPod Interface Cable (included)

MediaLink⁴

- Under Dash Interface Allows Portable Media Devices to be Connected
- MediaLink⁴ Includes the Following Connectivity:

- USB - Supports Hard Drives and Flash Memory Drives
- LinkDirect 8-pin DIN for iPod
- 3.5mm Audio Only Input
- RCA Audio /Video Input

Chassis

- 1.0 DIN (Import/ISO-DIN Mountable)
- Motorized/Swivel Flip-Out/Flip-Up LCD Screen
- 7" TFT Active Matrix LCD with Anti-Glare Coating
- Screen Tilt/Angle Adjustment
- Heat Management System - Forced-Air Cooling to Keep the Chip Sets Operating at Nominal Temperatures

General

- Bluetooth - Bluetooth hands-free profile for safety / convenience and A2DP profile for streaming music from a PDA / PMP
- Navigation Ready (Nav101 Only)
- 38-Key Infrared Remote Control with 5-way Joystick
- Two Composite Video Outputs for Additional Screens
- Compatible with MZ7TFT Rear Seat Monitors with Touch Screen Interface
- Two Audio /Video Auxiliary Inputs
- 200-Ohm Preamp Line Output - All Audio Channels
- 4VRMS Line Output - All Channels
- Rotary Encoder Audio Control
- Seven-Band EQ with Eight Preset EQ Curves
- Spectrum Analyzer
- Front, Rear, Center and Subwoofer Line Output
- Subwoofer Crossover and Phase Control
- Dolby Digital / Pro-Logic II
- Programmable Volume Control
- Rear Camera Input (Normal and Mirror Image View)
- Auto TFT Dimmer
- 5-Way Joystick

Optional Equipment

- **NAV101**
The VM9512 is "navigation ready." Before accessing any navigation features, you must purchase and install the NAV101 module. All installation and operating instructions will be included with the NAV101 navigation module.
Once the NAV101 is connected and operating properly, the NAV source mode will become active. While the NAV101 is not installed, the NAV option appears gray, indicating the function is not available.
- **Rear Camera**
The VM9512 is "camera ready." Before accessing any camera features, you must purchase and install a rear video camera. Once the rear camera is connected and operating properly, the CAMERA source mode will become active. While the camera is not installed, the CAMERA option appears gray, indicating the function is not available.
- **Satellite Radio Tuner**
See "Satellite Radio Operation" on page 22.
- **iPod**
See "MP3/WMA Operation" on page 29.
- **Bluetooth Phone**
See "Bluetooth Operation" on page 32.

Tools and Supplies

You will need these tools and supplies to install your VM9512:

- Torx type, flat-head and Philips screwdrivers
- Wire cutters and strippers
- Tools to remove existing radio (screwdriver, socket wrench set or other tools)
- Electrical tape
- Crimping tool
- Volt meter/test light
- Crimp connections
- 18 gauge wire for power connections
- 16 – 18 gauge speaker wire

Disconnecting the Battery

To prevent a short circuit, be sure to turn off the ignition and remove the negative (-) battery cable prior to installation.

NOTE: If the VM9512 is to be installed in a car equipped with an on-board drive or navigation computer, do not disconnect the battery cable. If the cable is disconnected, the computer memory may be lost. Under these conditions, use extra caution during installation to avoid causing a short circuit.

WARNING! Only connect the unit to a 12-volt power supply with proper grounding.

WARNING! Never install this unit where operation and viewing could interfere with safe driving conditions.

WARNING! To reduce the risk of a traffic accident (except when using for rear view video camera) never use the video display function while driving the vehicle. This is a violation of federal law.

WARNING! Never disassemble or adjust the unit.

WARNING! To prevent injury from shock or fire, never expose this unit to moisture or water.

WARNING! Never use irregular discs.

WARNING! To prevent damage to the mechanism inside this unit, avoid impact to the TFT monitor.

WARNING! Using an improper fuse may cause damage to the unit and result in a fire.

WARNING! The monitor employs an automatic motorized mechanism. To prevent damage to the core mechanism, please do not push, pull or swivel the monitor manually, other than in the manner explained in "Monitor Left/Right Angle Adjustment" on page 12.

WIRING DIAGRAM

* See the MediaLink and Satellite Connections diagram for more information about connecting a satellite receiver and an iPod (through the MediaLink).

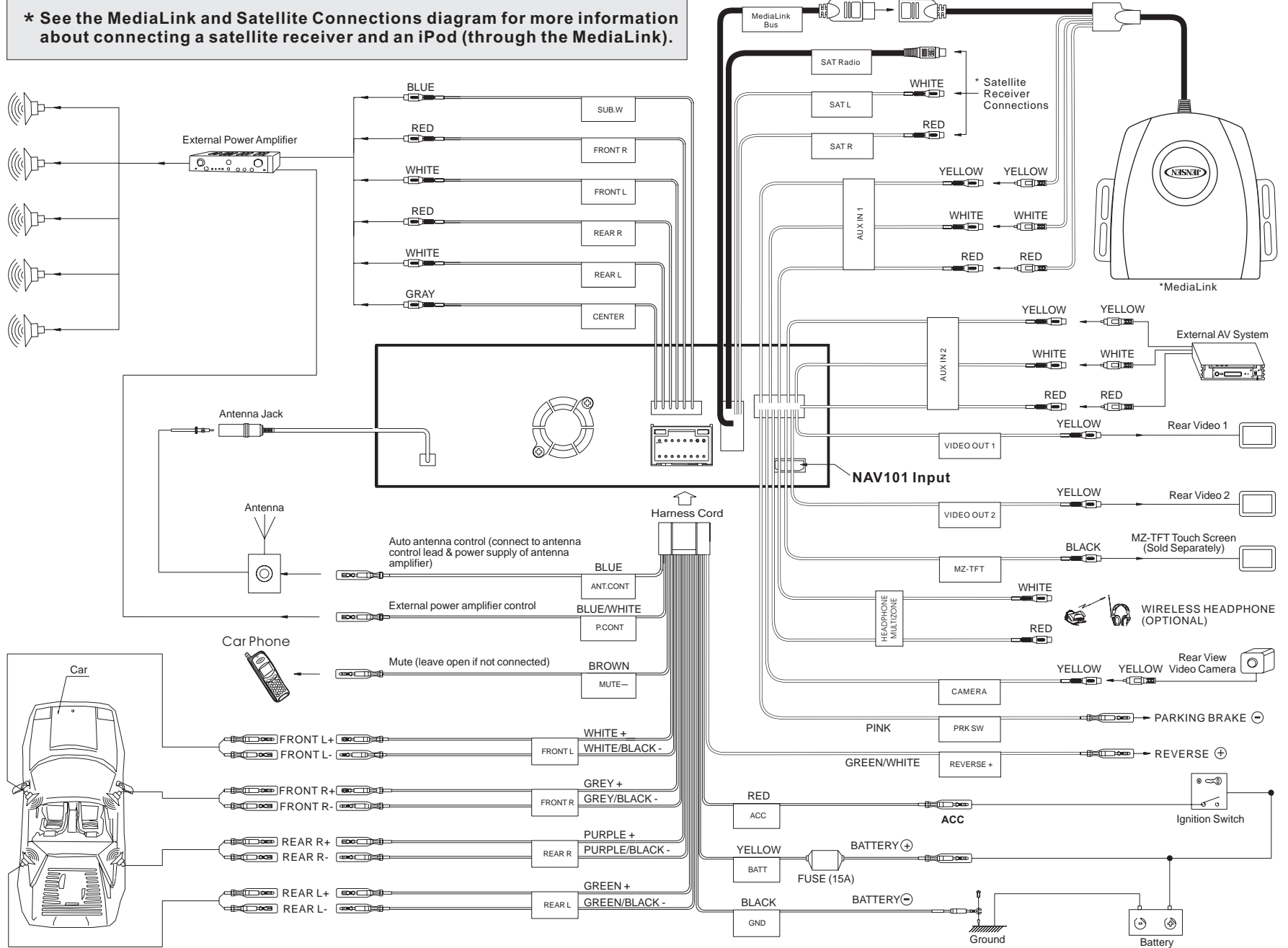

MEDIALINK AND SATELLITE CONNECTIONS

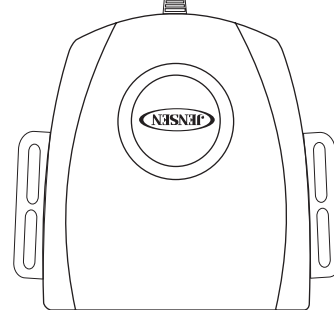
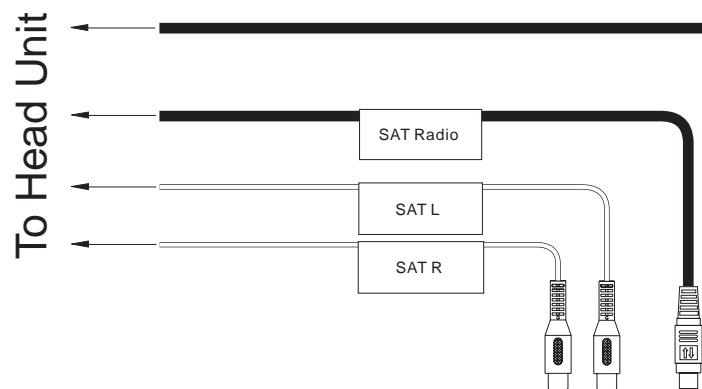

*SAT Cable Kit: JXMC or XMDJEN100 (sold separately)

**XM or Sirius satellite tuner (sold separately)

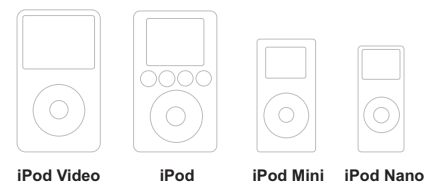
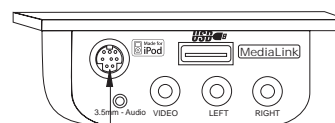
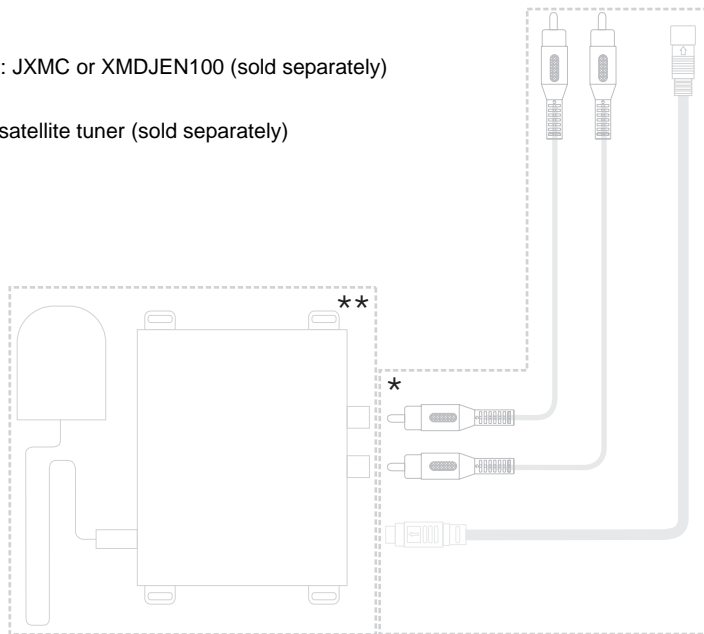

jLink iPod Cable (Included)

INSTALLATION

Pre-installation

1. Press the metal levers on both sides to remove the half-sleeve from the radio.

PREPARE RADIO

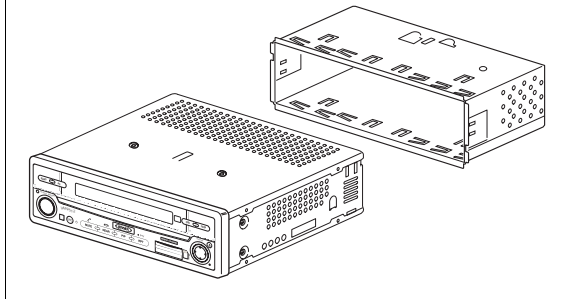

2. Install the half-sleeve.
 - a. Install adapter if necessary (optional).
 - b. Install half-sleeve into adapter or dashboard (use only the supplied screws). Do not force the sleeve into the opening or cause it to bend or bow.
 - c. Locate the series of bend-tabs along the top, bottom and sides of the mounting sleeve. With the sleeve fully inserted into the dashboard opening, bend as many of the tabs outward as necessary so that the sleeve is firmly secured to the dashboard.
 - d. Install support strap to make the unit more stable.

INSTALL HALF SLEEVE

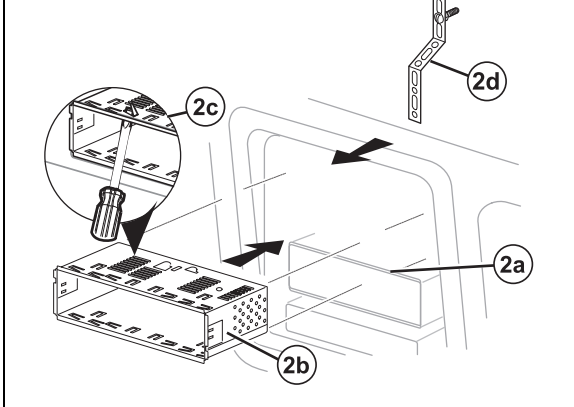

CAUTION! Be careful not to damage the car wiring.

3. Place the radio in front of the dashboard opening so the wiring can be brought through the mounting sleeve.

Wiring

Complete wiring as illustrated in the wiring diagram on page 3. Once the wiring is complete, reconnect the battery negative terminal. If there is no ACC available, connect the ACC lead to the power supply with a switch.

NOTE: When replacing a fuse, be sure to use correct type and amperage to avoid damaging the radio. The VM9512 uses one 10 amp mini-ATM fuse, located in the black filter box in-line with the main wire harness.

Final Installation

After completing the wiring connections, turn the unit on to confirm operation (ignition switch must be on). If unit does not operate, recheck all wiring until problem is corrected. Once proper operation is achieved, turn off the ignition switch and proceed with final mounting of the chassis.

1. Connect wiring adapter to existing wiring harness.
2. Connect antenna lead.
3. Carefully slide the radio into the half-sleeve, making sure it is right-side-up, until it is fully seated and the spring clips lock it into place.

NOTE: For proper operation of the CD/DVD player, the chassis must be mounted within 20° of horizontal. Make sure the unit is mounted within this limitation.

4. Attach one end of the perforated support strap (supplied) to the screw stud on the rear of the chassis using the hex nut provided. Fasten the other end of the perforated strap to a secure part of the dashboard either above or below the radio using the screw and hex nut provided. Bend the strap to position it as necessary.

CAUTION! The rear of the radio must be supported with the strap to prevent damage to the dashboard from the weight of the radio or improper operation due to vibration.

5. Replace any items you removed from the dashboard.

FINAL INSTALLATION

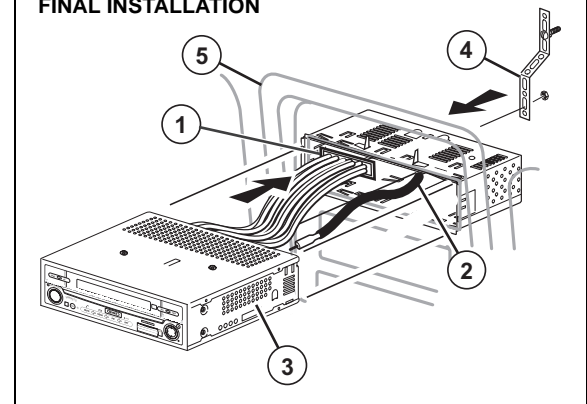

Final ISO-DIN Installation

1. Remove trim ring.
2. Mount factory brackets on new radio using existing screws from old radio.
3. Slide radio chassis into dash opening and secure.
4. Reinstall dash panel.

FINAL ISO-DIN INSTALLATION

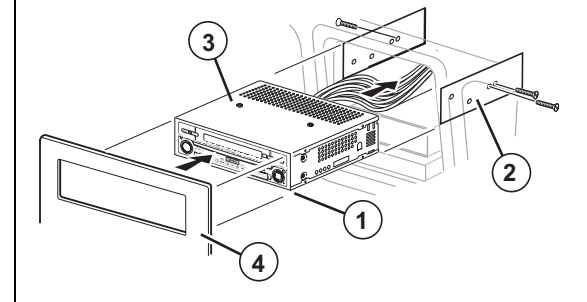

ANTI-THEFT FEATURE

The VM9512 is equipped with an anti-theft feature requiring the user to enter a password upon initial power on.

The default user password is 012345 (6 digits).

To change the anti-theft and RATINGS protection password, perform the following steps:

1. Press the **SETUP** button (31) on the remote control or touch the  button on the screen to enter the "SETUP" menu.
2. Touch **RATING** to view the "RATING" sub-menu. The small "lock" icon will be "unlocked".
3. Enter a new 6-digit password and press **ENTER**.

The "lock" icon will lock and the new anti-theft password will be set, as well as the password for RATING protection (see "Rating Sub-menu Features" on page 18).

NOTE: If you forget your password, contact Customer Service at 1-800-323-4815 for assistance.

CONTROLS AND INDICATORS

Button Operation

1. OPEN/CLOSE

Press to activate the automatic mechanical system and move the TFT monitor into viewing position. Press again to close the TFT.

2. DISP

With the TFT monitor open, press to cycle through information available on the TFT screen.

With the TFT monitor closed, *press and hold* to view the clock.

In DVD Mode, press to view the top and bottom information bars. Press again to turn "Display Off".

3. AS

Press to automatically store the first six strong stations in preset memory. Applies to current band only.

4. BAND

Press the **BAND** button to change the AM, FM or SAT band.

5. AUDIO

Rotate to adjust the volume. Press to enter and/or confirm audio settings.

6. SRC

Press to select playing mode.

7. LCD Display

8. MUTE

Press to silence the receiver. Press again to resume previous volume level.

BT Mode: Answer Bluetooth call.

NOTE: The VM9512 features Softmute, which will allow the volume to increase or decrease gradually when the MUTE function is activated or deactivated.

9. IR Remote Control Receiver

10. (left joystick)

DVD/Disc Mode: Press once to play back the previous chapter/track.

TUNER Mode: Press once to auto-search for the previous available radio station.

MENU Mode: Press once to move the cursor to the left.

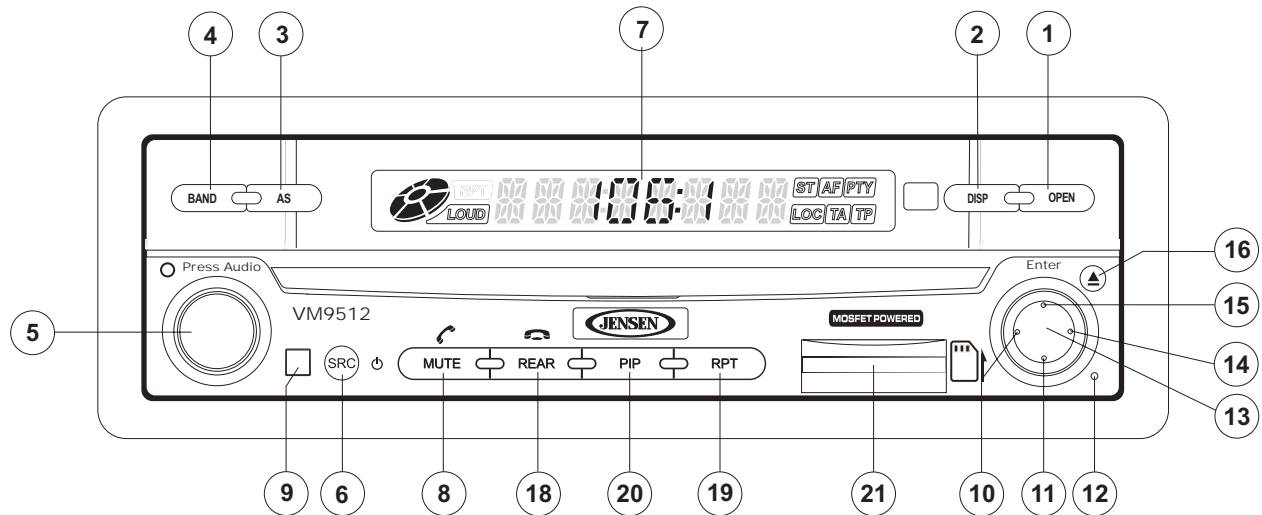

11. (down joystick)

DVD/Disc Mode: Press once for slow forward/slow reverse.

TUNER Mode: Press to go down one frequency step.

MENU Mode: Press once to move the cursor down.

12. Reset

Press to reset system settings to factory default (except the password and parental lock setting).

CONTROLS AND INDICATORS

13. Pause/Play/Enter

Press to pause or resume playback or to confirm current selection.

14. (right joystick)

DVD/Disc Mode: Press once to enter the next chapter or track.

TUNER Mode: Press once to auto-search the next available radio station.

MENU Mode: Press once to move the cursor to the right.

15. (up joystick)

DVD/Disc Mode: Press once for fast forward/fast reverse.

TUNER Mode: Press to go up one frequency step.

MENU Mode: Press once to move the cursor up.

16. (▲)

Press once for disc insertion/ejection.

Press and hold to reset core mechanism position.

17. TFT Display

18. REAR

Select rear zone source. Allows front passengers to listen to the radio while rear passengers listen to a CD, MP3, WMA or watch DVDs.

BT Mode: Disconnect Bluetooth call.

19. RPT

Press to control repeat playback function.

20. PIP

Activate Picture In Picture feature.

21. SD Card Slot

Insert SD card for playback of audio files.

22. WIDE

Press to adjust the display aspect of the picture to one of two settings: CINEMA, NORMAL or Standby (screen off).
NOTE: Only CINEMA and Standby are available for non-video sources.

Press and hold to adjust Brightness and Contrast.

23/24. ANGLE/TILT

Press to activate the tilt function. Press once to adjust the downward tilt angle of the screen one step at a time or press and hold to adjust the angle in a continuous motion up or down.

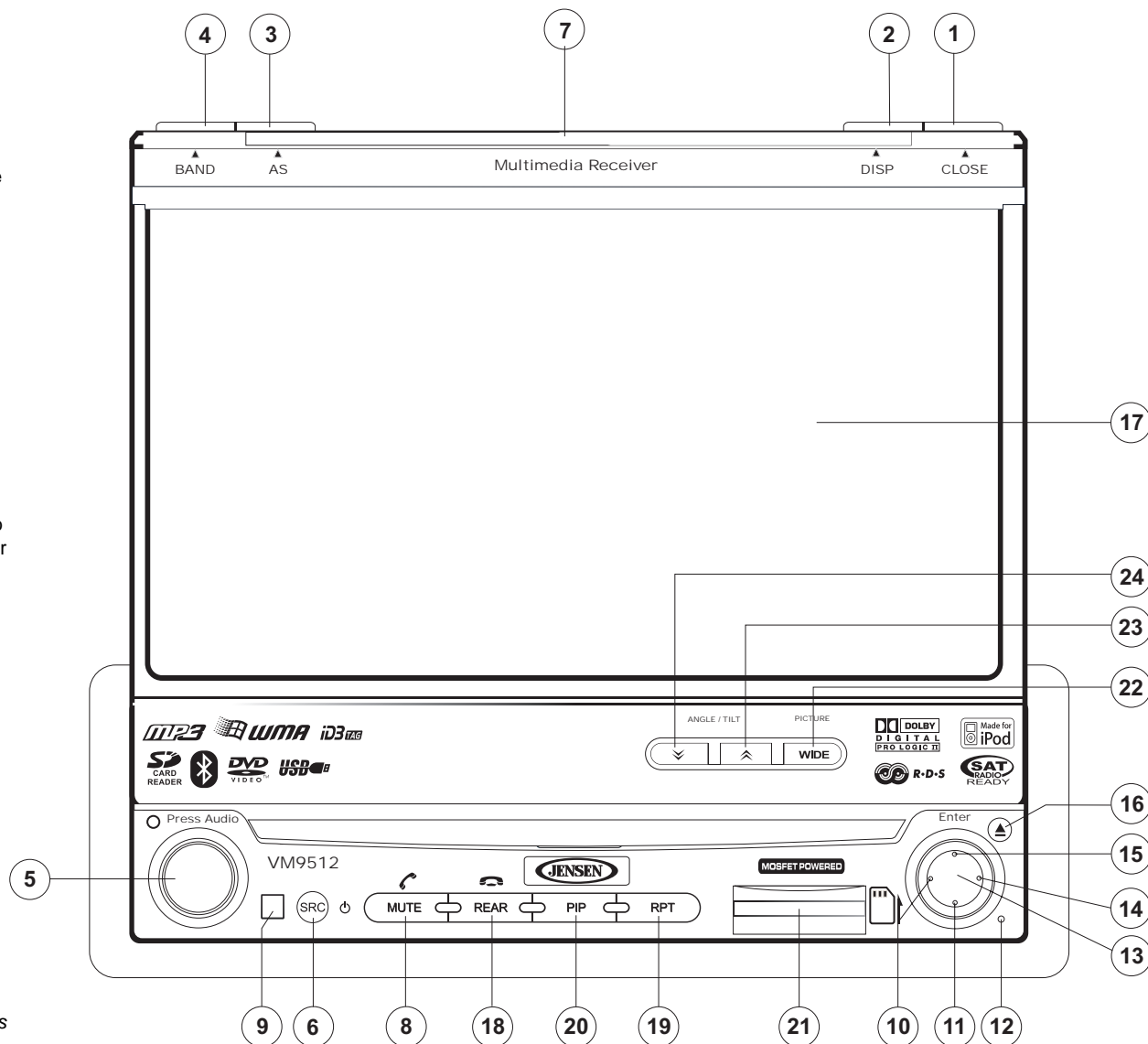

REMOTE CONTROL

The VM9512 Remote controls both the front and rear zones. To switch from front to rear zone, move the F/R switch (32) located on the right side of the controller.

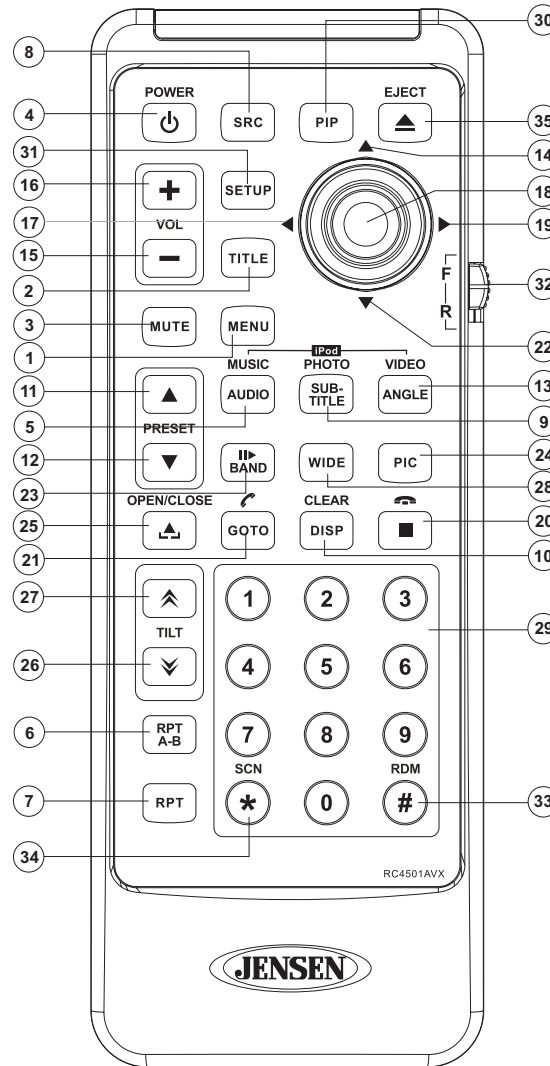

NOTE: Your remote control may differ slightly from the one pictured here. The above diagram is for illustrative purposes only.

Table 1: Remote Control Functions

Button		Function					
Name	Ref#	DVD	VCD	TUNER	CD/MP3	SATELLITE	iPod
MENU	1	Enters the main menu of the disc	Turns on/off PBC when playing VCD			Displays diagnostics screen	Displays iPod menu
TITLE	2	Enters the title menu of the disc	Plays first ten seconds of each chapter/title			Category list in CG mode	
MUTE	3	Toggles on/off audio output	Toggles on/off audio output	Toggles on/off audio output	Toggles on/off audio output	Toggles on/off audio output	Toggles on/off audio output
POWER/⏻	4	Turns the power on/off	Turns the power on/off	Turns the power on/off	Turns the power on/off	Turns the power on/off	Turns the power on/off
AUDIO	5	Changes the audio language for disc playback					Selects iPod Music mode
RPT A-B	6	Setup to repeat playback from time frame A to time frame B	Setup to repeat playback from time frame A to time frame B				
RPT	7	Repeats playback of current chapter	Repeats playback of current chapter		Repeats playback of current track		Repeats playback of current track
SRC	8	Selects playing source	Selects playing source	Selects playing source	Selects playing source	Selects playing source	Selects playing source
SUBTITLE	9	Language selection for subtitle					Selects iPod Photo mode
DISP/ CLEAR	10	Displays playing information/ Delete entry or move backwards to correct error in Direct Access mode	Displays playing information/ Delete entry or move backwards to correct error in Direct Access mode	Displays audio mode Delete entry or move backwards to correct error in Direct Access mode	Displays audio mode Delete entry or move backwards to correct error in Direct Access mode	Displays audio mode Delete entry or move backwards to correct error in Direct Access mode	Displays audio mode Delete entry or move backwards to correct error in Direct Access mode
PRESET ▲	11	Zooms in when playing DVD, DivX or Photo	Zooms in	Navigates the preset station list	Navigates list window	Navigates the preset station list	Navigates list window
PRESET ▼	12	Zooms out when playing DVD, DivX or Photo	Zooms out	Navigates the preset station list	Navigates list window	Navigates the preset station list	Navigates list window
ANGLE	13	Plays back disc in different angle (if available) for a scene	Plays back Picture CD with different angle (if available) of picture displayed	Switches MEM keypad off		Switches MEM keypad off	Selects iPod Video mode
Joystick ^	14	Fast forwards the disc content	Fast forwards the disc content		Fast forwards the disc content		Accesses iPod Menu
VOL -	15	Decreases volume	Decreases volume	Decreases volume	Decreases volume	Decreases volume	Decreases volume
VOL +	16	Increases volume	Increases volume	Increases volume	Increases volume	Increases volume	Increases volume
Joystick <	17	Selects the previous chapter for playback	Selects the previous chapter for playback	Searches an available radio station by decreasing tuning frequency	Selects the previous track for playback	Searches an available radio station by decreasing tuning frequency	Selects prior track
Joystick (press)	18	ENTER, Pauses playback/ starts playback	ENTER, Pauses playback/ starts playback	Auto memory scan	ENTER, Pauses playback/ starts playback	ENTER, Toggles the on-screen menu between CAT/ CH mode	ENTER
Joystick >	19	Selects the next chapter for playback	Selects the next chapter for playback	Searches an available radio station by increasing tuning frequency	Selects the next track for playback	Searches an available radio station by increasing tuning frequency	Selects the next track for playback
■	20	Stops playback	Stops playback		Stops playback		
GOTO	21	Enters Direct Access mode	Enters Direct Access mode	Enters Direct Access mode	Enters Direct Access mode	Enters Direct Access mode	Enters Direct Access mode
Joystick V	22	Fast reverses the disc content	Fast reverses the disc content		Fast reverses the disc content		Pauses playback/starts playback

Table 1: Remote Control Functions

Button		Function					
Name	Ref#	DVD	VCD	TUNER	CD/MP3	SATELLITE	iPod
>/BAND	23	Slow Forward/Slow Reverse X2, X4, X8	Play/pause	Selects AM/FM Band.	Play/pause	Selects SAT1, SAT2 or SAT3 band.	
PIC	24	Displays Brightness/Contrast Controls	Displays Brightness/Contrast Controls	Displays Brightness/Contrast Controls	Displays Brightness/Contrast Controls	Displays Brightness/Contrast Controls	Displays Brightness/Contrast Controls
OPEN/CLOSE	25	Opens/closes the TFT monitor	Opens/closes the TFT monitor	Opens/closes the TFT monitor	Opens/closes the TFT monitor	Opens/closes the TFT monitor	Opens/Closes the TFT monitor
TILT ⚓	26	Decreases monitor tilt angle	Decreases monitor tilt angle	Decreases monitor tilt angle	Decreases monitor tilt angle	Decreases monitor tilt angle	Decreases monitor tilt angle
TILT ⚓	27	Increases monitor tilt angle	Increases monitor tilt angle	Increases monitor tilt angle	Increases monitor tilt angle	Increases monitor tilt angle	Increases monitor tilt angle
WIDE	28	Selects display mode: CIN-EMA, NORMAL or Standby	Selects display mode: CIN-EMA, NORMAL or Standby	Selects display mode: CIN-EMA or Standby	Selects display mode: CIN-EMA or Standby	Selects display mode: CIN-EMA or Standby	Selects display mode: CIN-EMA or Standby
1, 2, 3, 4, 5, 6, 7, 8, 9, 0 (Numeric Keypad)	29	Directly accesses chapter		1-6 selects preset for current band	Directly accesses track	1-6 selects preset for current band	
PIP	30	Picture In Picture view of Front source, Rear Zone or NAV	Picture In Picture view of Front source, Rear Zone or NAV	Picture In Picture view of Front source, Rear Zone or NAV	Picture In Picture view of Front source, Rear Zone or NAV	Picture In Picture view of Front source, Rear Zone or NAV	Picture In Picture view of Front source, Rear Zone or NAV
SETUP	31	Displays Setup menu	Displays Setup menu	Displays Setup menu	Displays Setup menu	Displays Setup menu	Displays Setup menu
F/R	32	F controls front zone R controls rear zone	F controls front zone R controls rear zone	F controls front zone R controls rear zone	F controls front zone R controls rear zone	F controls front zone R controls rear zone	F controls front zone R controls rear zone
RDM	33	Plays all chapters in random order			Plays all tracks in random order		Plays all tracks in random order
SCN	34			Preview scan	Plays the first ten seconds of each track	Preview scan	
EJECT	35	Ejects disc	Ejects disc	Ejects disc	Ejects disc	Ejects disc	Ejects disc

USING THE TFT MONITOR

Open/Close TFT Monitor

Open TFT Monitor

Press the **OPEN** button (1) on the front panel or press the (▲) button (25) on the remote control to activate the mechanism that moves the display panel into the viewing position.

Close TFT Monitor

Press the **OPEN** button (1) on the front panel or press the (▲) button (25) on the remote control to load the display panel back into the compartment.

TFT Monitor Auto Open

If "TFT Auto Open" is "on" when the unit is turned on, the monitor automatically moves to the viewing position.

If "TFT Auto Open" is "off" when the unit is turned on, press the **OPEN** button (1) or (▲) button (25) on the remote control to move the monitor into the viewing position.

If "TFT Auto Open" is set to "Manual", the TFT will not close when the key is turned off.

Monitor Tilt Angle Adjustment

A known characteristic of LCD panels is the quality of the display in relationship to the viewing angle. The monitor angle can be adjusted for optimum viewing using one of the following methods.

Step by Step Angle Adjustment

Press the (▲) or (▼) button on the control panel (23, 24) or remote control (26, 27) to adjust the tilt angle of the screen one step at a time.

Continuous Angle Adjustment

Press and hold the (▲) or (▼) button on the control panel or remote control to adjust the tilt angle in a continuous motion.

Monitor Left/Right Angle Adjustment

To manually adjust the left/right angle of the TFT screen, follow these steps:

1. Make sure the TFT screen is "Out". Press the **OPEN** button (1), if necessary.

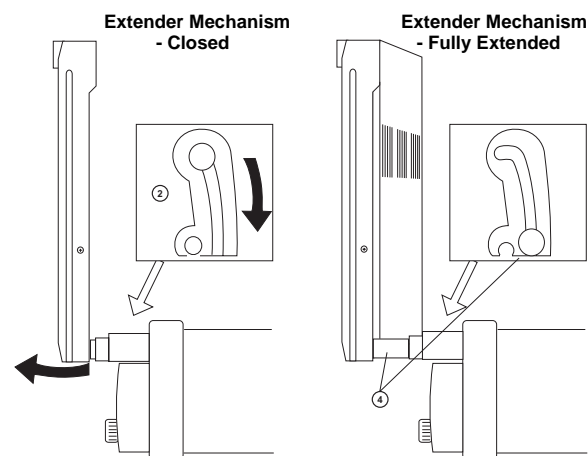

2. Locate the extender mechanism behind the screen.
3. Firmly grasp both sides of the screen near the bottom.
4. Gently pull on either the left or right side until the extender mechanism becomes fully extended.

Reverse Driving Use

If the rear-view video camera is connected, the unit is on, and the monitor is stationed inside the main compartment of the unit, the monitor automatically moves into the viewing position and switches to CAMERA mode upon reverse driving. When the reverse driving stops, the monitor returns to the main storage compartment.

If the monitor is in display mode, the monitor automatically switches to CAMERA mode upon reverse driving. When the reverse driving stops, the monitor returns to its original input mode.

Aspect Ratio

Press the **WIDE** button (28) on the remote control or **WIDE** button (22) on the monitor to adjust the aspect ratio as follows (only active with video source):

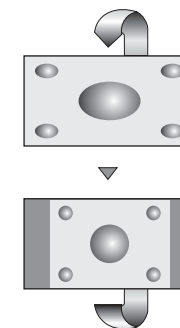

CINEMA

The entire screen is extended horizontally to the aspect ratio of 16 to 9. The extension ratio is the same at any point.

NORMAL

The conventional display image has a 4 to 3 ratio of horizontal to vertical, leaving a blank area on the right and left sides of the display.

STANDBY

Screen becomes black. Touch screen to resume.

Image Setting

Table 2 shows the video output mode for each playing source.

Table 2: Video Output Modes

Playing Source	Video Output Modes
RADIO	RGB Mode
SAT	RGB Mode
DISC	RGB Mode
BT	RGB Mode
AUX 1	CVBS Mode
AUX 2	CVBS Mode
NAV	RGB Mode
CAMERA	CVBS Mode

*CVBS – Composite Video Baseband Signal

Parameter Adjustment Procedure

1. **Enter Picture Quality Setting Mode:**
Press the **PIC** button (24) on the remote control or *press and hold* the **WIDE/PICTURE** button (22) on the monitor.
2. **Select Item to Set:**
Use the up/down joystick buttons to select "BRIGHT" or "CONTRAST".
3. **Set Parameters:**
Use the left/right joystick buttons to modify the settings.
4. **Exit Picture Quality Setting Mode:**
Press the **PIC** button on the remote control or the **WIDE/PICTURE** button on the monitor

Parking Brake

Parking Brake Inhibit

When the pink "Parking" wire is connected to the vehicle brake switch, the front TFT monitor will display video only when the parking brake sequence is engaged. Before starting the parking brake sequence, the radio must be on with the video media disc inserted and playing.

Parking Brake Sequence

There are two situations that can start the Parking Brake Sequence (this is the preferred method). The timing window is between 3 ~ 5 seconds.

- Parking brake is engaged (on) when the vehicle is started or the accessory/ignition is turned on. To activate video, the following sequence of events must be completed:
 - a. Release parking brake for 3 ~ 5 seconds.
 - b. Reapply parking brake.
 - c. Video should be displayed on the TFT monitor within 1 ~ 2 seconds.
- Parking break is disengaged (off) when the vehicle is started or the accessory/ignition is turned on. To activate video, the following sequence of events must be completed:
 - a. Set parking brake for 3 ~ 5 seconds.
 - b. Release parking brake for 3 ~ 5 seconds.
 - c. Reapply parking brake.
 - d. Video should be displayed on the TFT monitor within 1 ~ 2 seconds.

Monitor Movement Mechanism

If an obstruction occurs in the monitor path, the following protective measurements can be executed to prevent damage to the mechanism or monitor:

Table 3: Monitor Protective Measures

Obstruction	Self Protection	OPEN Button Pressed	Power Reconnected
Monitor loading out horizontally	Unit stops at obstruction point	Monitor fully extended horizontally	Monitor is automatically loaded into unit
Monitor loading in horizontally	Unit stops at obstruction point	Monitor fully extended horizontally	Monitor is automatically loaded into unit
Monitor loading out vertically	Unit stops at obstruction point	Monitor swivels back to the unit	Monitor swivels back to the unit
Monitor loading in vertically	Unit stops at obstruction point	Monitor swivels back to the unit	Monitor swivels back to the unit

After the protective procedure is executed, normal operation is resumed by pressing the **OPEN** button (1) or disconnecting and reconnecting the power.

OPERATING INSTRUCTIONS

Power On / Off

Press the **⏻/SRC** button (6) on the unit (or the **⏻/POWER** button (4) on the remote control) to turn the unit on. The buttons on the front of the unit light up and the current mode status appears in the LCD (7). You can also turn on the unit by pressing the **OPEN** button (1) and opening the TFT screen.

Press and hold the **⏻** button to power off the unit. The monitor is drawn back into the main compartment.

Audible Beep Confirmation

An audible beep tone confirms each function selection. The Beep tone can be disabled through the Setup menu.

Volume Adjustment

To increase or decrease the volume level, turn the rotary encoder (5) on the front panel or press the **VOL+ / VOL-** buttons (15, 16) on the remote control. When the volume level reaches "0" or "40", a beep sounds, indicating that the adjustment limit has been reached. The volume ranges from "0" to "40". The LCD or TFT screen displays the volume level for 3 seconds.

Programmable Turn-On Volume

This feature allows the user to select a turn-on volume setting regardless of the volume setting prior to turning the unit off. To program a specific turn-on volume level, turn the **AUDIO** control (2) to adjust the volume to the desired turn-on volume. Push and hold the **AUDIO** button while the yellow speaker icon and level indication is displayed on the screen. The unit will beep two times to confirm your turn-on volume setting.

Mute

Press the **MUTE** button on the front panel (8) or remote control (3) to mute the volume from the unit. Press the **MUTE** button again to restore the volume. "MUTE" is displayed on the LCD. Adjusting the volume or using any of the audio setup features cancels the mute function.

Line Mute

If the "MUTE" wire is connected, audio output mutes when a telephone call is received by the car phone.

Playing Source Selection

Press the **SRC** button on the front panel (6) or remote control (8) to change between available playing sources in the following order: RADIO, SAT, DISC, NAV, BT, iPod, SD, USB,

AUX1, AUX2 and CAMERA. The playing mode is displayed on the TFT and LCD screens.

Auxiliary Devices

External peripheral devices can be connected to this unit via RCA output or MediaLink⁴. Select "AUX1" or "AUX2" mode to access and control connected auxiliary devices.

Source Menu

To access the SOURCE MENU, touch the TFT screen in the top left corner of the screen.

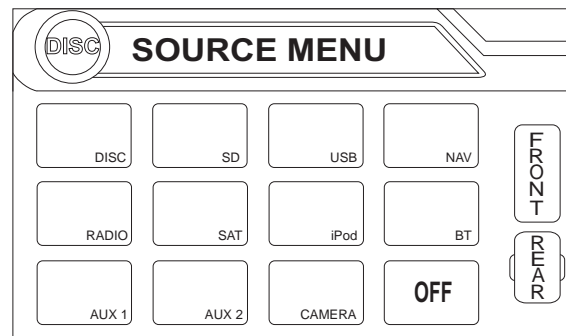

This menu allows you to select a source for the front or rear zone. Touch FRONT or REAR to choose the zone for which you would like to specify the source. (See "Multi-ZONE Operation" on page 16.)

Audio Control Menu

The Audio Control menu features a 7-band graphic equalizer, which allows you to easily adjust your audio system to meet the acoustical characteristics of your vehicle, which vary depending on the type of vehicle and its measurements. Proper setting of the Fader and Balance boosts the effects of the cabin equalizer.

Press the **AUDIO** button (5) on the front panel to display the audio menu. To adjust an audio feature:

1. Use the left/right joystick buttons to highlight the audio feature to be adjusted.
2. Press the joystick **ENTER** button on the control panel (13) or remote control (18) to select the highlighted option.
3. Use the joystick to adjust the selected feature to the desired setting.

Table 4: Audio Adjustments

Function	Adjustment Options	
EQ	User	In user mode, you can manually adjust each of the seven frequency bands.
	Acoustic	Use the on-screen arrows to select a predefined equalization curve.
	Urban	
	Rave	
	Latin	
	Dance	
	Hip Hop	
Rock		
FAD-BAL	Use this screen to adjust the output level for each speaker in your surround system from 0 to -24dB. You can also adjust the master volume from this screen.	

NOTE: The EQ mode will automatically change to "USER" when individual EQ bands are adjusted.

Proper setting of the Fader and Balance complement the effects of the cabin equalizer.

The Audio menu will automatically exit after a few seconds of inactivity. To exit quickly, touch the top left corner of the screen or press and hold the **AUDIO** button (5).

Alternate Display Options

A menu located on the left side of the screen provides immediate access to the Equalizer, Rear Zone screen view and PIP (Picture in Picture) features.

- **EQ:** Touch to view Spectrum Analyzer > Equalizer.
- **REAR:** Touch to view the Rear Zone screen. Control options appear below the PIP image, depending on the source.

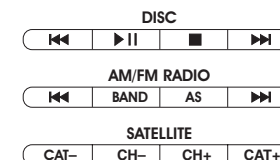

- **PIP:** Touch to view the Rear Zone, current Front Zone, or NAV screen. Use the left/right arrows below the PIP image to change the PIP source.

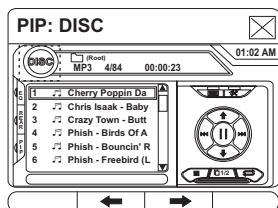

System Reset

To correct a system halt or other illegal operation, use the tip of a pen to press the reset button (12) located on the front bottom-right corner of the unit. After a system reset, the unit restores all factory default settings.



[RESET] Button

NOTE: *If the unit is reset while a DVD is playing, the DVD resumes play once the reset is complete.*

MULTI-ZONE OPERATION

Independent sources can be played simultaneously on the VM9512. For example, a video game console can be seen on the front screen while DVD video is available to rear passengers.

Connecting the Rear Zone Touch Screen

You can connect up to two additional monitors (sold separately) for rear passengers, one of which can be a Touch Screen. You can also connect a wireless headphone system to one of your rear monitors, as illustrated below.

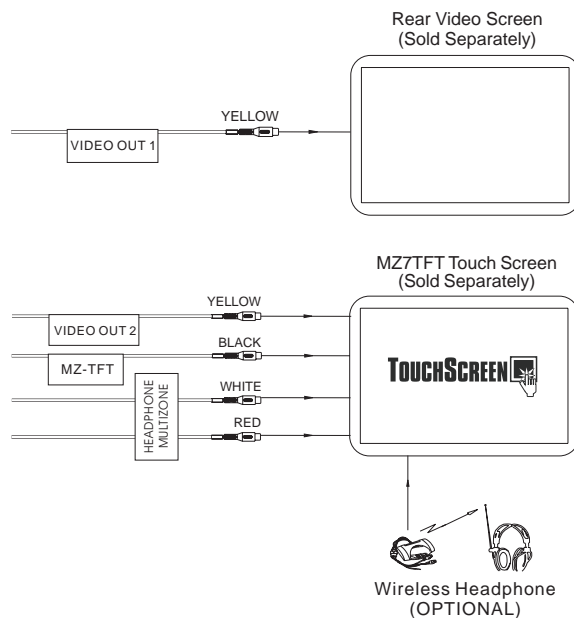

Changing the Rear Zone Source

To access the SOURCE MENU, touch the TFT screen in the top left corner of the screen.

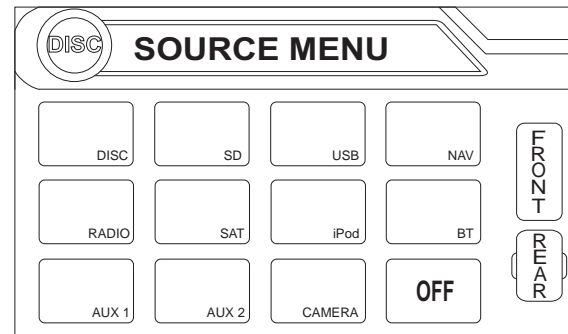

This menu allows you to select a source for the front or rear zone. Touch FRONT or REAR to choose the zone for which you would like to specify the source.

Controlling the Rear Zone Screen(s)

If you have a rear touch screen installed, you can touch the screen to control most rear zone functions.

You can also use the remote control. The VM9512 remote controls both the front and rear zones. To switch from front to rear zone, move the F/R switch (32) located on the right side of the remote controller.



NOTE: You cannot change or control the front zone source from the rear zone video screen.

Touch the **REAR** button on the left side of the screen to view a "Picture in Picture" image of the rear screen.

Turning the Rear Screen Off

Touch the OFF button (on the SOURCE MENU) to suspend operation of the rear screen. Any operation assigned exclusively to the rear source will be suspended until reactivated using either the front or rear zone touch screen or the remote control.

SETUP MENU

To access system settings, press the **SETUP** button (31) on the remote control or touch the button on the screen to enter the "SETUP" menu. The "GENERAL" sub-menu appears highlighted in blue.

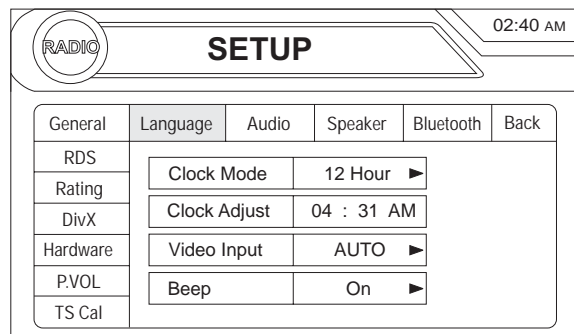

Accessing Menu Items

Touch the sub-menu name or use the joystick to select a sub-menu (Language, Audio, RDS, etc.).

The features available for adjustment under the highlighted sub-menu option will appear in the center of the screen.

Adjusting a Feature

1. Use the touchscreen or press the **Λ** or **V** buttons on the joystick to select the feature to be adjusted.
2. Enter the option field for the feature you want to adjust by using the touchscreen or pressing the **ENTER** (joystick) button. A submenu appears in a second row with the selected option highlighted in blue.
3. Select a new value by using the touchscreen or pressing the **Λ** or **V** buttons on the joystick.
4. Use the touchscreen or press the **ENTER** (joystick) button to confirm setup.

General Sub-menu Features

Setting	Options	Function
Clock Mode	12 Hour	Clock displays 12 hour time using AM and PM.
	24 Hour	Clock displays 24 hour time up to 23:59.

Setting	Options	Function
Clock Adjust	(HH:MM)	The clock appears in the top right corner of the screen and on the LCD screen during certain operations. NOTE: The AM/PM indication will change as you continue to adjust the hour past 12.
Video Input (Input circuitry autodefects the video signal from the Aux In source).	NTSC	The color signals are output in the standard NTSC format.
	PAL	The color signals are output in the standard PAL format.
	Auto	The color signal output is switched automatically based on the current video input signal - NTSC or PAL.
Beep	On	When turned on, an audible beep tone confirms each function selection.
	Off	No beep sounds.

Language Sub-menu Features

If a DVD supports more than 1 Subtitle or Audio language, all the languages are available for selection during playback. If the selected language is not supported by the DVD, then the default language is used.

Setting	Options	Function
OSD	English	On Screen Display appears in English.
DVD Audio	English	DVD Audio is heard in English when the option is available.
	Spanish	DVD Audio is heard in Spanish when the option is available.
	French	DVD Audio is heard in French when the option is available.
DVD Subtitle	English	DVD subtitles automatically appear in English when available.
	Spanish	DVD subtitles automatically appear in Spanish when available.
	French	DVD subtitles automatically appear in French when available.
	Off	DVD subtitles do not appear automatically.
Disc Menu	English	DVD menu (if applicable) is displayed in English.
	Spanish	DVD menu (if applicable) is displayed in Spanish.
	French	DVD menu (if applicable) is displayed in French.

Audio Sub-menu Features

Setting	Options	Function
DRC	Off	Employ the Dynamic Range Control for better playback for low volumes.
	On	
Audio Mode	Surround	Choose Stereo to send the same signal to the front and rear left/right speakers. If you have a center speaker, you can choose the Surround option when supported by your media.
	Stereo	
Dolby Pro II	Music	Optimized for music reproduction when playing music encoded in Dolby.
	Movie	Optimized for video reproduction when playing movies encoded in Dolby.
	Matrix	Use with Dolby Matrix encoded media.
Sub. W Filter	50Hz	Selecting a crossover frequency sets a cut-off frequency of the subwoofer's LPF (low-pass filter).
	80Hz	
	100Hz	
	120Hz	
	150Hz	

Speaker Sub-menu Features

- Choose **4 CH**, **4.1 CH** or **5.1 CH** depending on the speaker configuration in your vehicle.
- Use the **Test Tone** feature to verify speaker settings. Make changes using the EQ/FAD-BAL menu, accessed by pressing and holding the **AUDIO** button (volume control).
- Subwoofer Phase Adjustment: Touch the **sub.w** icon to access the subwoofer polarity controls and reverse the subwoofer signal polarity from **0°** to **180°**. Reversing polarity can improve bass response related to speaker configuration.
- Delay Setting: Delay is available when the media is Dolby Digital encoded or digital bitstream.
 - **RL** and **RR** only are available in 4.0 and 4.1 mode
 - Touch the **RL**, **RR** and **Cent** speaker icons to access the delay setting
 - L and R Rear channels: 0 - 15 msec
 - Center channel: 0 - 5 msec

Bluetooth Sub-menu Features

Setting	Options	Function
Bluetooth	On	Enable Bluetooth function.
	Off	Disable Bluetooth function.
Auto Answer	On	The unit automatically answers all incoming calls.
	Off	Manually answer calls by touching the "call" button.
Connect	Manual	Connect the last active mobile phone by touching the CONNECT icon when disconnected.
	Auto	Automatically connect when your paired phone is in range.
Pairing Code		The default code is "1234". Touch the keypad icon to open the keypad and enter the pairing code or pass key required for Bluetooth connection to your mobile phone. Not all phones/devices require a pairing code. The default code is "0000" for many models.

RDS Sub-menu Features

Setting	Options	Function
RDS	On	Unit will display Radio Data System information when available.
	Off	
CT	On	Automatically synchronize the radio's time based on RDS radio signals.
	Off	

Setting	Options	Function
Tuner Region	USA	AM Frequency Spacing - 10kHz AM Frequency Band - 530kHz~1720kHz FM Frequency Spacing - 200kHz FM Frequency Band - 87.5MHz~107.9MHz
	America 1	AM Frequency Spacing - 10kHz AM Frequency Band - 530kHz~1720kHz FM Frequency Spacing - 100kHz FM Frequency Band - 87.5MHz~108.0MHz
	Arabia	AM Frequency Spacing - 9kHz AM Frequency Band - 531kHz~1620kHz FM Frequency Spacing - 100kHz FM Frequency Band - 87.5MHz~108.0MHz
	China	AM Frequency Spacing - 9kHz AM Frequency Band - 522kHz~1620kHz FM Frequency Spacing - 100kHz FM Frequency Band - 87.5MHz~108.0MHz
	America 2	AM Frequency Spacing - 5kHz AM Frequency Band - 520kHz~1600kHz FM Frequency Spacing - 100kHz FM Frequency Band - 87.5MHz~108.0MHz
	Europe	AM Frequency Spacing - 9kHz AM Frequency Band - 522kHz~1620kHz FM Frequency Spacing - 50kHz FM Frequency Band - 87.5MHz~108.0MHz
	Korea	AM Frequency Spacing - 9kHz AM Frequency Band - 531kHz~1602kHz FM Frequency Spacing - 200kHz FM Frequency Band - 88.1MHz~107.9MHz
	OIRT (International Radio and Television Organization)	AM Frequency Spacing - 9kHz AM Frequency Band - 531kHz~1602kHz FM Frequency Spacing - 200kHz FM Frequency Band - 88.1MHz~107.9MHz

Rating Sub-menu Features

The DVD system has a built-in parental lock feature to prevent unauthorized persons from viewing restricted disc content. By default, the rating system is set at the highest setting (with no restrictions). The parental lock is released

only by entering the correct password. Once the password is entered, rating is available for setup.

Setting	Options	Function
Password	-----	Enter the default six-digit password (012345).
Rating	1. Kid Safe	Select the appropriate rating level for the intended audience. You may override higher ratings by using your password.
	2. G	
	3. PG	
	4. PG-13	
	5. PG-R	
	6. R	
	7. NC-17	
	8. Adult	
Load Factory	Reset	Select "Reset" to restore the factory default settings for the <i>Rating system only</i> .

To reset the password, access the "RATING" menu and enter the current password. Once the correct password is entered, you can access the "Password" field and enter a new one.

NOTE: Record the password and keep it in a safe place for future reference. The rating for each disc is marked on the disc, disc packing, or documentation. If the rating is not available on the disc, the parental lock feature is unavailable. Some discs restrict only portions of the disc and the appropriate content will play. For details, please refer to the disc description.

DivX Sub-Menu Features

Select the DivX sub-menu to view your DivX registration code. You must use this code to register your player, allowing you to purchase video using the DivX Video On Demand format.

Hardware Sub-menu Features

If the rear-view video camera is connected, the unit is on, and the TFT monitor is retracted inside the unit, the TFT monitor automatically moves into the viewing position and Camera mode is selected upon shifting into REVERSE gear. When shifting into DRIVE gear, the TFT monitor is retracted back inside unit after ten seconds.

Setting	Options	Function
Camera In	Normal	
	Mirror	Reverse the camera image as if looking through a rear-view mirror.
TFT Auto Open	Auto	The TFT panel automatically opens when the unit is turned on.
	Manual	When the ignition is turned OFF, the TFT panel DOES NOT retract if it was previously out
	Off	You must press the OPEN button (1) to open the TFT panel.
TFT Set Back	Off	TFT screen remains fully extended.
	On	TFT screen moves back slightly after opening.
Auto Dimmer	Off	TFT screen brightness remains constant unless manually adjusted.
	On	TFT screen will automatically dim when less light is available.

If the monitor is in display mode, the monitor automatically switches to CAMERA mode upon reverse driving. When the reverse driving stops, the monitor return to its original input mode.

P.VOL Sub-menu Features

Setting	Options	Function
Source	DISC	Choose a source for which you would like to increase the relative volume (LEVEL). Use the +/- buttons to increase relative volume for specified source up to 6 decibels.
	RADIO	
	SD	
	SAT	
	AUX 1	
	USB	
	BT	
	AUX 2	
	iPod	
	NAV	

TS Cal (Screen Calibration)

To access the “Screen Calibration” function from the SETUP menu, select the “TS CAL” option.

After entering calibration mode, a crosshair + appears in a corner quadrant of the screen. To begin calibration, *press and hold* the crosshair for one second until it moves to the next quadrant. Continue for each quadrant until the calibration is completed.

To exit without performing calibration, touch the **BACK** button.

Exiting the System Setup Menu

To exit setup mode and resume normal playback, press the **SETUP** button (31) on the remote control or touch the **BACK** button on the screen.

TUNER OPERATION

Tuner TFT Display

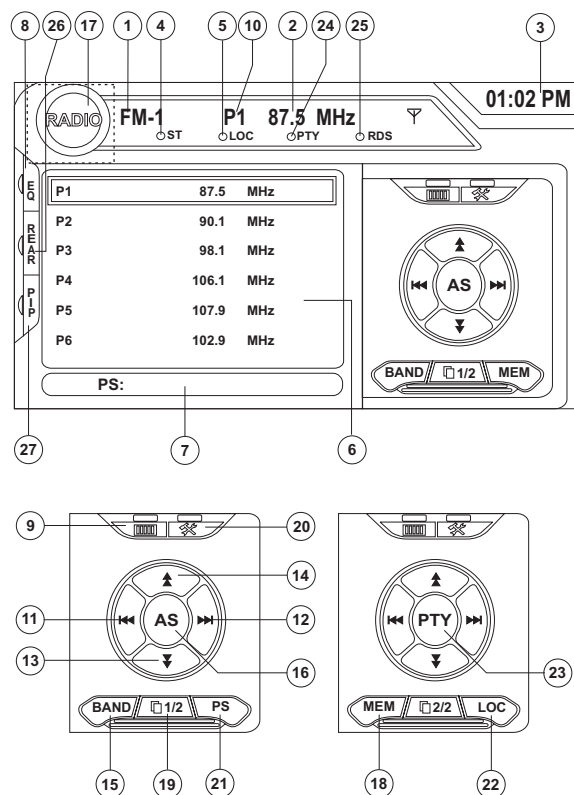

1. Current radio band indicator
2. Radio frequency indicator
3. Clock
4. Stereo broadcasting indicator
5. Strong Local signal broadcasting indicator
6. Preset radio stations: Touch to recall preset stations
7. RDS Information: PS (Program Service), PTY (Program Type), RT (Radio Text)
8. **EQ**: Touch to view Spectrum Analyzer > Equalizer
9. Touch to access the direct entry screen
10. Current preset station indicator
11. **<<**: Touch to seek backward
12. **>>**: Touch to seek forward
13. **∨**: Touch to tune backward one step

14. **∧**: Touch to tune forward one step
15. **BAND**: Touch to change between AM/FM bands
16. **AS**: Touch to automatically store stations
17. Touch to view the **SOURCE MENU** and select a new playback source
18. **MEM**: View screen used to enter current channel into preset memory
19. **1/2** or **2/2**: Touch this page button to view a second page of on-screen buttons
20. Touch to view the **SETUP** menu
21. **PS** (Preview Scan): Touch to scan all stations available, stopping for 5 seconds at each and continuing until a station is selected
22. **LOC**: Touch to tune to strong local stations
23. **PTY**: When **PTY** is pressed, the Program Type categories are listed, allowing listeners to find similar programming by genre. When a **PTY** category is selected from the touch screen menu, the radio will start scanning for the selected category.
24. Indicates the **PTY** function is activated
25. Indicates the **RDS** function is activated
26. **REAR**: Touch to view the Rear source screen
27. **PIP**: Touch to view Rear, Front or NAV source

Switch to Radio Tuner source

- Touch the top left corner of the screen (the **RADIO** circle) to view the **SOURCE MENU**. Touch "RADIO".
- Press the **SRC** button (6) on the front panel or remote control (8) to switch to the AM/FM or RADIO source.

Select FM/AM Band

Touch the **BAND** button (15) on the screen, or press the **BAND** button on the unit (4) or remote control (20) to change between the following bands: FM1, FM2, FM3, AM1, and AM2.

NOTE: The BAND button on the unit only works when the TFT is closed.

Seek Tuning

To seek the next higher station:

- Touch the **>>** button on screen.
- Move the joystick to the right.

To seek the next lower station:

- Touch the **<<** button on screen.
- Move the joystick to the left.

Manual Tuning

To increase or decrease the tuning frequency one step:

- Touch the **∧** or **∨** buttons on screen.
- Move the joystick left/right.

Direct Tuning

To enter a radio station directly, touch the button or press the **GOTO** button (21) on the remote control to display the direct entry menu.

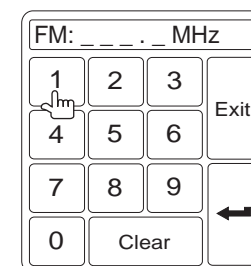

Enter the desired radio station using the on-screen number pad. Press **Enter** to tune to the selected station. To exit the screen without changing the station, touch **Exit**. To clear your entry and start over, touch **Clear**.

Using Preset Stations

Six numbered preset buttons store and recall stations for each band. All six stored stations (P1-P6) for the current band appear on the screen.

Storing a Station

1. Select a band (if needed), then select a station.
2. Touch the on-screen **MEM** button (18) to open the preset screen.

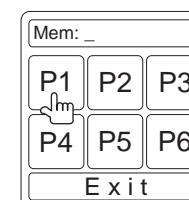

3. Touch the preset number in which you would like to store the current station (or press **EXIT** to cancel and

close the menu). The preset number and station appears highlighted.

Recalling a Station

1. Select a band (if needed).
2. Touch an on-screen preset button (6) to select the corresponding stored station.

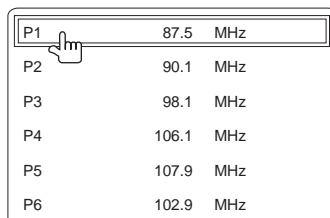

P1	87.5	MHz
P2	90.1	MHz
P3	98.1	MHz
P4	106.1	MHz
P5	107.9	MHz
P6	102.9	MHz

Auto Store (AS)

To select six strong stations and store them in the current band:

1. Select a band (if needed).
2. Press the **AS** button (3) on the control panel or touch **AS** on the screen for 2 seconds to activate the Auto Store function.

The new stations replace stations already stored in that band.

Preview Scan (PS)

To scan the AM or FM band for a preview of available stations in your particular area, touch the **PS** button (21). Touch again to stop preview scan.

Local Radio Station Seeking (LOC)

When the Local function is on, only radio stations with a strong local radio signal are played. To activate the Local function in AM/FM tuner mode, touch the **1/2** button to access the second screen of menu options, and then touch the on-screen **LOC** button. Touch the **LOC** button again to turn Local off. When the Local function is active, the LOC indicator at the top of the screen is illuminated.

SATELLITE RADIO OPERATION

Listeners can subscribe to XM® Radio on the Web by visiting www.xmradio.com, or by calling (800) 967-2346. Customers should have their Radio ID ready (see "Displaying the Identification (ID) Code"). Customers can receive a limited number of free-to-air channels without activation.

Listeners can subscribe to Sirius® Radio on the Web by visiting www.sirius.com, or by calling (888) 539-SIRIUS. Customers should have their Sirius ID ready (Sirius ID is located on the Satellite Radio Tuner, sold separately). Customers can listen to music samples by tuning to channel 184.

Accessing Satellite Radio Mode

Press the **SRC** button (8) on the front panel or remote control (8) to switch to the SAT source.

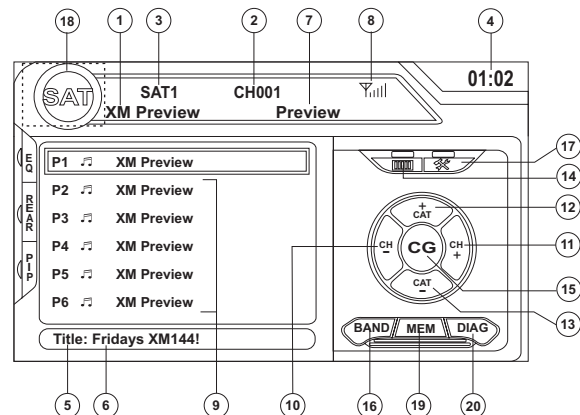

1. SAT channel name
2. SAT channel number
3. SAT band
4. Time
5. Song title
6. Artist name
7. Song category
8. Signal strength indicator
9. Current preset channels/on-screen preset buttons
10. **CH -**: Select the previous channel
11. **CH +**: Select the next channel
12. **CAT +**: Select next channel in current category only

13. **CAT -**: Select previous channel in current category only
14. Touch to enter channel directly using keypad on screen
15. **CG**: Access Channel/Category Guide mode
16. **BAND**: Change between SAT1, SAT2 and SAT3 bands
17. Touch to view the SETUP menu
18. Touch this area to view the SOURCE MENU and select a new playback source
19. **MEM**: View screen used to enter current channel into preset memory
20. **DIAG**: This feature is reserved for use by service professionals for troubleshooting.

Displaying the Identification (ID) Code

Before you listen to satellite radio, you must subscribe to the service using your radio's identification number. To display the radio ID, press the left/right buttons (16, 17) on the joystick or the **CH -** or **CH +** buttons on the touch screen repeatedly to tune to channel "000". The screen displays the radio ID where the channel name is usually displayed.

Selecting a Station

Use the left/right joystick buttons or the **CH -** or **CH +** buttons on the touch screen to change to another station.

Preset Mode

To enter preset mode, touch the **BAND** button on the screen, or press the **BAND** button on the unit (14) or remote control (20) to change between the following bands: SAT1, SAT2, or SAT3 (indicated in the top left corner of the TFT screen).

Six numbered preset buttons store and recall stations for each band. All six stored stations (P1-P6) for the current band appear on the TFT screen.

Storing a Station

1. Select a band (if needed), then select a station.
2. Touch the on-screen **MEM** button (18) to open the preset screen.

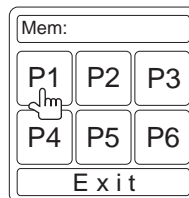

3. Touch the preset number in which you would like to store the current station (or press **EXIT** to cancel and close the menu). The preset number and station appears highlighted.

Recalling a Station

1. Select a band (if needed).
2. Touch an on-screen preset button to select the corresponding stored station.

Direct Tuning

To enter a radio station directly, touch the button or press the **GOTO** button (21) on the remote control to display the direct entry menu.



Enter the desired radio station using the on-screen number pad. Touch the **Enter** button to tune to the selected station. To exit the screen without changing the station, touch **Exit**. To clear your entry and start over, touch **Clear**.

Channel/Category Guide Mode

There are two search modes to help navigate through channels and or categories. To access the Channel/Category Guide mode, press the **ENTER** button (18) on the remote control or the **CG** button on the touch screen.

Channel Guide is the default search mode. To access Category Guide, press the **TITLE** button (2) on the remote control or touch **CAT** on the touch screen. To return to the Channel Guide, touch **CH** on the screen or press the **SUBTITLE** button (9) on the remote control.

Channel Guide Mode

When Channel Guide mode is selected, the first six satellite channels are displayed in the boxes in the bottom left of the TFT screen and the on-screen menu changes to facilitate search mode.

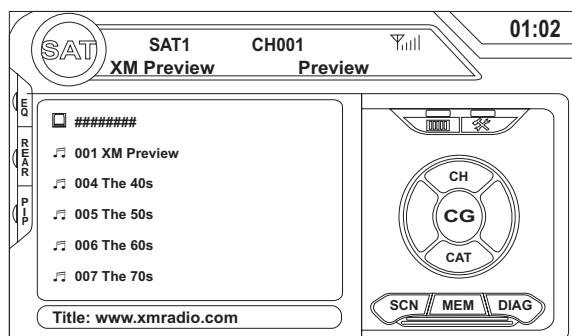

- While in Search Mode, to switch between Channel and Category search modes, press the **CH** or **CAT** buttons on the touch screen.
- Use the scroll bar and arrows on the touch screen to view the next/previous page of stations. Each page contains six channels to select from.
- Press the on-screen **SCN** button to preview each of the 6 channels displayed for 10 seconds.
- Press the **CG** button to return to the Preset Mode screen.
- To select a channel while in Channel Guide mode, touch the channel name on the screen. The channel will begin playing and the unit will return to the Preset Mode.

Category Guide Mode

When Category Mode is selected, folder icons appear on the screen next to category choices.

- While in Search Mode, to switch between Channel and Category search modes, press the **CH** or **CAT** buttons on the touch screen.
- Use the scroll bar and arrows on the touch screen to view the next/previous page of categories. Each page contains six categories to select from.
- To select a category, touch the corresponding category name or folder icon. The channels in that category will be displayed on the screen.
- Use the scroll bar and arrows on the touch screen to view the next/previous six stations in the selected category.
- Touch the on-screen **SCN** button to preview each channel in the selected category for 10 seconds.
- Touch the channel name to play that channel.
- Touch the on-screen **CG** button to return to the Preset Mode screen.

DVD/VCD VIDEO OPERATION

NOTE: When properly installed, DVD video cannot be displayed on the main TFT screen unless the parking brake is applied. If you attempt to play a DVD while the vehicle is moving, the TFT screen displays "PARKING" with a blue background. Rear video screens, if applicable, will operate normally.

Opening/Closing the TFT Video Screen

Opening the TFT Screen

To open the TFT video screen, press the **OPEN** button (1). The unit beeps and then opens.

Closing the TFT Screen

Press the **OPEN** button (1) again to close the TFT screen. If the screen is in the "IN" position, it moves out before closing.

Insert/Eject Disc

Upon inserting a DVD disc, DVD mode is entered and disc play begins.

NOTE: If Parental Lock (Rating) is activated and the disc inserted is not authorized, the 6-digit code must be entered and/or the disc must be authorized (see "General Sub-menu Features" on page 17).

You cannot insert a disc if there is already a disc in the unit or if the power is off.

NOTE: DVD-R and DVD-RW will not play unless the recording session is finalized and the DVD is closed.

Ejecting a Disc

Press the **▲** button (21) on the unit or remote control (35) to eject the disc. The unit automatically reverts to Tuner mode. You may eject a disc with the unit powered off. The unit will remain off after the disc is ejected.

Reset the Loading Mechanism

If the disc loads abnormally or an abnormal core mechanism operation occurs, press and hold the **▲** button (21) on the unit or remote control (35) to reset the loading mechanism. Normal operation resumes.

Accessing DVD Mode

To switch to DVD mode when a disc is already inserted, press the **SRC** button (15) on the front panel or remote control (8) until "DISC" appears at the bottom of the screen.

Controlling Playback

To access the on-screen controls, touch the screen. Touch the **1/2** button to view a second page of controls

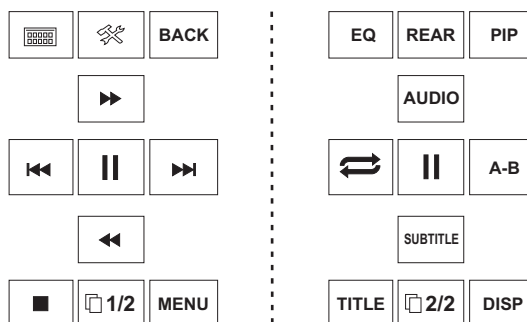

Stopping Playback

Touch the stop button (■) on the screen or press the **■ / BAND** button (20) on the remote control to stop DVD play.

Pausing Playback

Touch the pause button (||) on the screen (or press the **>||** button on the remote control) to suspend disc playback. Press the **>** button on the screen to resume disc playback.

Fast Forward Playback

Press the **Λ** button on the joystick or the **>>** button on the screen to fast forward. Keep pressing and releasing the button to increase the rate from "2X" to "4X", "6X", and "8X". Press the joystick enter button (18) on the remote control or touch the play button (**>**) to resume normal playback.

Fast Reverse Playback

Press the **V** joystick button or touch the **<<** button on the screen to play the current title in fast reverse. Keep pressing and releasing the button to increase the rate from "2X" to "4X", "6X", and "8X".

Press the joystick **ENTER** button (18) on the remote control or touch the play button (**>**) to resume normal playback.

Slow Forward/Slow Reverse Playback

Press the **||>**/**BAND** button on the remote control to slow forward/slow reverse. Keep pressing and releasing the button to increase the slow forward rate from "2X" to "4X" and "8X" and then begin slow reverse.

Repeat Playback

Press the **RPT** button (19) on the control panel, the **RPT** button (7) on the remote control, or the **↺** button on screen to alter repeat mode according to the following:

- DVD: Repeat Chapter, Repeat Title, Repeat Off
- VCD (PBC Off): Repeat Single, Repeat Off

NOTE: For VCD play, the repeat function is not available if PBC is on.

Sectional Repeat Function (A-B)

Use the **A-B** function to define a specific area of a disc to repeat.

- Press the **RPT A-B** button (6) on the remote control (or the **A-B** button on screen) to set the start point (A) of the repeated section.
- Press the **RPT A-B** button again once you reach the desired end point (B) of the repeated section. The selected portion of the DVD will now repeat continuously.
- Press the **RPT A-B** button again to cancel the **A-B** section setting and stop repeat play.

Random Playback

With a DVD, VCD, or CD playing, press the **RDM** button on the control panel (21) or remote control (33) to activate random playback and play all chapters/tracks in random order. "On" appears on the screen.

Press the **>** button on the joystick to play the next random track.

Press the **RDM** button again to turn random play off.

NOTE: When a VCD is playing with PBC turned "On", activating random playback automatically turns PBC off.

Picture in Picture (PIP)

Press the **PIP** button (30) on the remote control to view a Picture in Picture image of the Front source, Rear Zone or NAV screen. Use the left/right arrows at the bottom of the image to change the PIP source.

Accessing the DVD Menu

Press the **MENU** button (1) on the remote control to recall the main DVD menu. Use the joystick to select a title from the menu or touch the title on screen.

Press the **TITLE** button (2) on the remote control or on screen to select a different title for playback.

Press the **ENTER** (joystick) button to confirm your selection and begin playback. You can also select a title using the touch screen.

Moving Through Chapters

Press the **>** button on the joystick or the **>>|** button on screen to advance to the next chapter on the DVD.

Press the **<** button on the joystick or the **|<<** button on screen to move to the previous chapter.

Direct Chapter / Track Selection

Remote Control Direct Entry

During DVD, VCD and CD playback, you can use the numeric keypad on the remote control (29) to access a track directly.

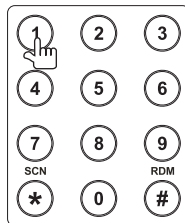

Touch Screen Direct Entry

To select a title, chapter/track, or specific playback time

directly, touch the button on screen control to display the direct entry menu.

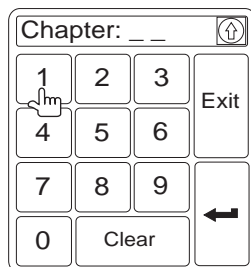

Use the button to select Title, Chapter, or Time entry.

- Title: _/#
- Chapter: _ _/###
- Time: _ : _ : _

Enter the desired title, chapter/track, or time using the on-screen number pad and then press the **Enter** button. To exit the screen without making a selection, touch **Exit**. To clear your entry and start over, touch **Clear**.

Viewing an Alternate Picture Angle (DVD Only)

Some DVDs contain scenes that have been shot simultaneously from different angles. For discs recorded with multiple angles, press the **ANGLE** button (13) on the remote control to toggle available angles of the on-screen image.

Zooming

Press the **PRESET** **Λ** and **V** buttons (11, 12) on the remote control to enlarge and pan through the video image using the following options: "ZOOM 1.5", "ZOOM 2", "ZOOM 3", and "OFF".

Multi-Language Discs (DVD Only)

Changing Audio Language

If you are watching a disc recorded in multiple languages, press the **AUDIO** button (5) on the remote control to choose a language.

Changing Subtitle Language

If you are watching a disc recorded in multiple languages with subtitles, press the **SUBTITLE** button (9) on the remote control to choose the language in which you would like the subtitles to appear.

NOTE: During VCD playback, press the AUDIO button (5) on the remote control to choose between Left Channel, Right Channel, and Stereo.

PBC (Play Back Control - VCD Only)

For VCDs with play back functionality, play back control (PBC) provides additional controls for VCD playback.

Press the **MENU** button (1) on the remote control to toggle the PBC function "On"/"Off". Once PBC is on, playback starts from track 1 of the play list.

NOTE: When PBC is activated, fast forward, slow playback, and previous/next track are available. Repeat and direct track selection are not available.

When PBC is activated, selecting random, scan, or search playback automatically deactivates PBC.

Playback Information

During DVD and VCD playback, press the **DISP** button on the control panel (2) or remote control (10) to display playback information on the screen, including the media playing and current playback time.

DVD Playback Information

The following information is displayed at the top of the screen during DVD playback:

- Title: 05/08 – "05/08" indicates the fifth of 8 titles on the DVD is currently playing.
- Chapter: 012/016 – "002/016" indicates that the second of 16 titles on the DVD is currently playing.
- 00:41:28 – "00:41:28" indicates the playback time of the current title.

The following information is displayed at the bottom of the screen:

- Front: Source
- Rear: Source
- CLOCK

VCD Playback Information

The following information is displayed at the top of the screen during VCD playback:

- VCD 2.0 – Format of current disc.
- Title: 06/18 – "06/18" indicates the sixth of 18 tracks on the VCD is currently playing.
- 00:02:18 – "00:02:18" indicates the playback time of the current track.

General Disc Information

Table 5: Disc Properties

Symbol	12cm Disc Properties	Max Play Time
	Single side single layer (DVD-5) Single side double layer (DVD-9) Double side single layer (DVD-10) Double side double layer (DVD-18)	(MPEG 2 Method) 133 minutes 242 minutes 266 minutes 484 minutes
	Single side single layer (VCD)	(MPEG 1 Method) 74 minutes
	Single side single layer	74 minutes

Table 6: Disc Symbols

Symbol	Meaning
	Number of voice languages recorded. The number inside the icon indicates the number of languages on the disc (maximum of 8).
	Number of subtitle languages available on the disc (maximum of 32).
	Number of angles provided (maximum of 9).
	Aspect ratios available. "LB" stands for Letter Box and "PS" stands for Pan/Scan. In the example on the left, the 16:9 video can be converted to Letter Box video.
	Indicates the region code where the disc can be played. <ul style="list-style-type: none"> • Region 1: USA, Canada, East Pacific Ocean Islands • Region 2: Japan, Western Europe, Northern Europe, Egypt, South Africa, Middle East • Region 3: Taiwan, Hong Kong, South Korea, Thailand, Indonesia, South-East Asia • Region 4: Australia, New Zealand, Middle and South America, South Pacific Ocean Islands/Oceania • Region 5: Russia, Mongolia, India, Middle Asia, Eastern Europe, North Korea, North Africa, North-West Asia • Region 6: Mainland China • ALL: All regions

DVD/CD AUDIO OPERATION

Instructions for TFT control and Insert/Eject are the same for DVD and CD operation. Please see the DVD/Disc Video Operation section for information about these topics.

The VM9512 will play music or other audio files from the following disc media:

- CD-DA
- CD-R/RW
- DVD
- DVD+R/RW
- DVD-R/RW

Upon inserting a disc with the TFT screen open, the disc and track title (if available), along with the track number and playing time appear on the screen.

CD Player User Interface

The on-screen indicators and touch key areas for CD playback are outlined below.

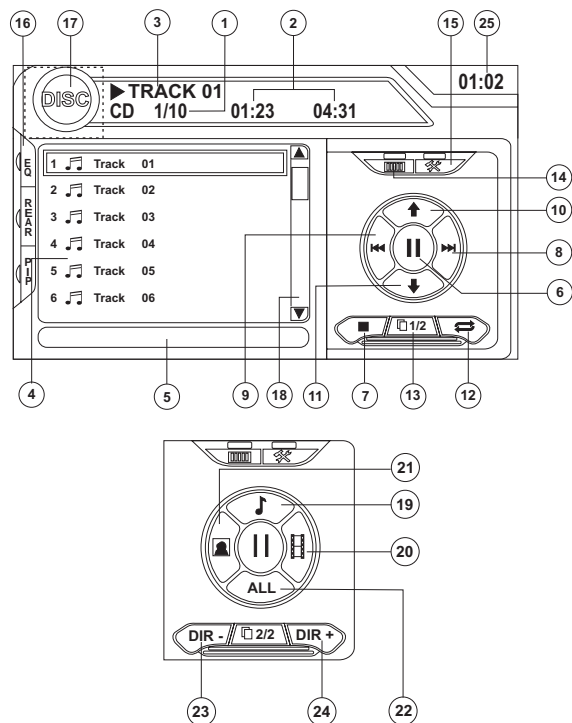

1. Current track and total number of tracks on disc

2. Elapsed playing time/length of track
3. Current track title
4. Available track titles
5. ID3 information
6. ||: Touch to pause/play disc playback
7. ■: Touch to stop disc playback
8. >>|: Touch to move to next track
9. |<<: Touch to move to previous track
10. ↑/>>: Touch to navigate playlist/touch to fast forward
11. ↓/<<: Touch to navigate playlist/touch to fast rewind or reverse
12. Touch to activate/deactivate Repeat play mode
13. 1/2 or 2/2: Touch this page button to view a second page of on-screen buttons
14. Touch to access the direct entry screen
15. Touch to view the SETUP menu
16. Touch to view Spectrum Analyzer > Equalizer
17. Touch to view the SOURCE MENU and select a new playback source
18. Touch the scroll bar and arrows to view the previous/next page of songs
19. Touch to access the Music menu
20. Touch to access the Video menu
21. Touch to access the Photo menu
22. Browse all files
23. DIR -: Touch to view the previous folder
24. DIR +: Touch to view the next folder
25. Current time

Controlling Playback

Stopping Playback

Touch the ■ button on screen or press the ■ button (20) on the remote control to stop disc playback.

To resume playback, touch the ► button on screen or press the joystick button.

Pausing Playback

Touch the ► button on screen or press the joystick button to suspend or resume disc playback.

Moving Through Tracks

Press the >>| button (19) on the remote control or on screen or use the > button on the joystick to advance to the next track on the disc.

Press the |<< button (17) on the remote control or on screen or use the < button on the joystick to move to the previous track.

Repeat Playback

Touch the ⇌ button on screen, press the RPT button on the remote control (7) control panel (19) to alter repeat mode according to the following:

- DVD: Repeat Chapter, Repeat Title, Repeat Off
- CD-DA: Repeat One, Repeat All, Repeat Off
- CD-R/RW: Repeat One, Repeat All, Repeat Off
- DVD-R/RW: Repeat One, Repeat All, Repeat Off

Track Scan Select (CD-DA discs only)

During disc play, press the SCN button on the remote control (34) or control panel (20) to play the first 10 seconds of each track. When a desired track is reached, press the SCN button again to cancel the function and play the selected track.

Random Play Select

While disc play is stopped, press the RDM button on the remote control (33) to play the tracks on the disc in a random, shuffled order. Touch the RDM button again to cancel Random Play mode.

NOTE: CD-R and CD-RW will not play unless the recording session is finalized.

Fast Forward

Touch the ↑ button on screen or press the ▲ button on the joystick to fast forward. Keep pressing and releasing the button to increase the rate from "2X" to "4X", "6X", and "8X".

Fast Reverse

Touch the ↓ button on screen or press the ▼ button on the joystick to fast reverse. Keep pressing and releasing the button to increase the rate from "2X" to "4X", "6X", and "8X".

Direct Track Entry

To select a track directly, touch the  button on screen to display the direct entry menu.

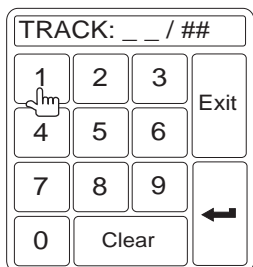

Enter the desired track number using the on-screen number pad, and then press the **Enter** button. To exit the screen without making a selection, touch **Exit**. To clear your entry and start over, touch **Clear**.

MP3/WMA OPERATION

Instructions for TFT control and Insert/Eject are the same for DVD and MP3 operation. Please see the DVD/Disc Video Operation section for information about these topics.

MP3/WMA Media and File Requirements

This player allows you to play back MP3 and WMA files recorded onto CD-R/RWs, DVD+R/RWs, and DVD-R/RWs. For CD-RW discs, please make sure it is formatted using the full method and not the quick method to prevent illegal disc operation.

Up to 1500 songs/files can be burned onto a disc for a MEGA DVD music mix. Do not exceed this number of songs/files or disc readability problems may occur.

MP3 Format Compatibility

The file naming formats listed below are compatible with this unit:

- ISO 9660 – file name: 12 characters, file extension: 3 characters
- ISO 9660 – file name: 31 characters, file extension: 3 characters
- Joliet – 64 characters

If the file or folder name does not conform to ISO 9660 file system standards, it may not be displayed or played back correctly. Use the following settings when compressing audio data for your MP3 disc:

- Transfer Bit Rate: 128kbps
- Sampling Frequency: 48kHz

When recording MP3 up to the maximum disc capacity, disable additional writing. For recording on an empty disc up to maximum disc capacity, use the "Disc at once" setting.

MP3 Playing Order

When selected for play, files and folders (Folder Search, File Search or Folder Select) are accessed in the order they were written by the CD writer. As a result, the order in which they are expected to be played may not match the order in which they are actually played. You may be able to set the order in which MP3/WMA files are to be played by writing them onto a medium such as a CD-R with their file names beginning with play sequence numbers such as "01" to "99".

For example, a medium with the following folder/file hierarchy is subject to Folder Search, File Search or Folder Select, as shown below.

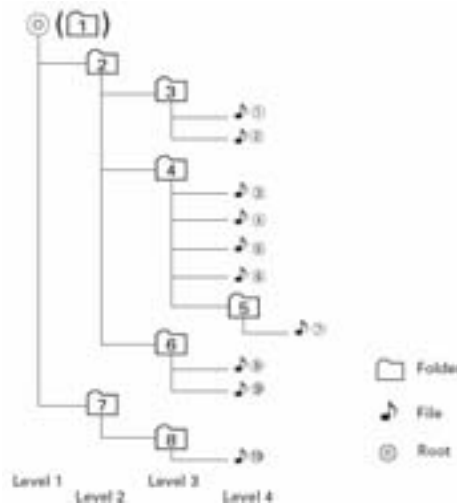

The VM9512 player will only recognize three folder levels and does not display folders containing only other folders. In the example above, the unit will display folders 3, 4, 6, and 8, but not 2 and 7 since they do not contain any tracks directly. Folder 5 is not recognized at all since it is at the fourth level.

Loading an SD Card

Insert the SD card into the SD slot (21) on the front of the radio. The unit will read the audio media files on the card automatically.

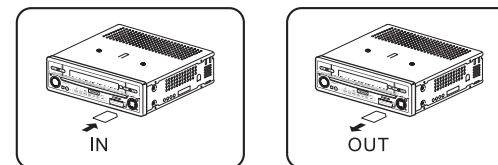

To remove the card, first press the **SRC** button (6) to switch to another mode and stop SD playback. Pull the SD card out to remove it.

Loading a USB Device

1. Locate the USB jack located on the MediaLink⁴.

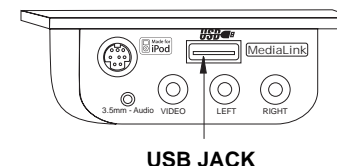

2. Insert the USB device into the USB jack. The unit will read the audio media files on the USB device automatically.

To remove the USB device, press the **SRC** button (6) to switch to another mode and then remove the USB device from the USB jack.

MP3 User Interface

The on-screen indicators and touch key areas for MP3 playback are outlined below.

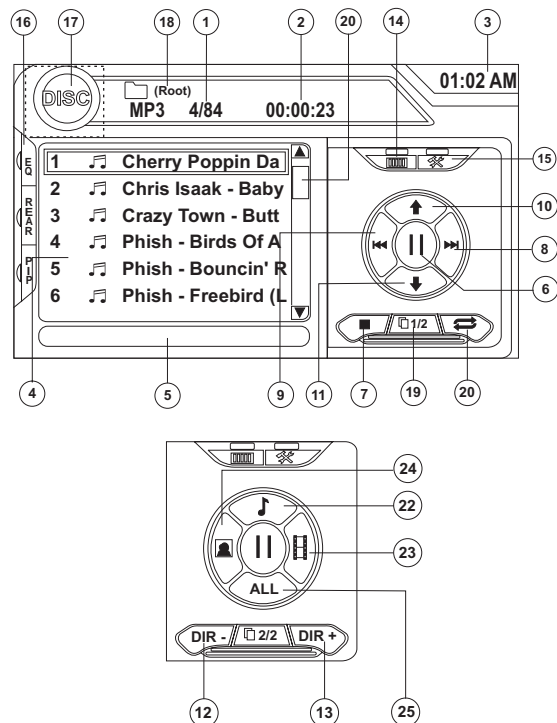

1. Current track and total number of tracks on root of disc
2. Elapsed playing time, track length
3. Current time
4. Track titles
5. ID3 information
6. || : Touch to play/pause disc playback
7. ■: Touch to stop disc playback
8. >>|: Touch to move to next track
9. |<<: Touch to move to previous track
10. ↑/>>: Touch to navigate playlist/touch to fast forward
11. ↓/<<: Touch to navigate playlist/touch to fast rewind or reverse
12. DIR -: Touch to view the previous folder
13. DIR +: Touch to view the next folder
14. Touch to access the direct entry screen
15. Touch to view the SETUP menu
16. Touch to view Spectrum Analyzer > Equalizer

17. Touch to view the SOURCE MENU and select a new playback source
18. Folder name
19. 1/2 or 2/2: Touch this page button to view a second page of on-screen buttons
20. Touch the scroll bar and arrows to view the previous/next page of songs
21. Touch to activate/deactivate Repeat play mode
22. Touch to access the Music menu
23. Touch to access the Video menu
24. Touch to access the Photo menu
25. Browse all files

Controlling MP3/WMA Disc Playback

Playing MP3/WMA Files

After inserting a MP3/WMA disc, files will play in the sequence of the "Root" directory.

NOTE: When burning MP3 / WMA files onto a DVD disc, use the 2X or 4X burning option, if available. This slower burning speed will help eliminate buffer errors and increase disc reading reliability. Also, use folders when burning large numbers of songs / files to a disc for easy music navigation. Select the "Disc at Once" option and close your disc.

Stopping Playback

Touch the ■ button on screen or press the ■/BAND button (20) on the remote control to stop disc playback.

To resume playback, touch the ► button on screen, press the joystick button (13) on the front panel, or press the >|| button (18) on the remote control.

Pausing Playback

Touch the ► button on screen, press the joystick button (13) on the front panel, or press the >|| button (18) on the remote control to suspend or resume disc playback.

Moving Through Tracks

Press the >>| button (19) on the remote control or on screen or use the > button on the joystick (14) to advance to the next track on the disc.

Press the |<< button (17) on the remote control or on screen or use the < button on the joystick (10) to move to the previous track.

Repeat Playback

Touch the ⇌ button on screen, press the RPT button (19) on the control panel or press the RPT button (7) on the remote control to alter repeat mode according to the following: Repeat Single, Folder Repeat, Repeat Off.

Random Play Select

Press the RDM button (33) on the remote control to play the files on the disc in a random, shuffled order. Press RDM again to cancel Random Play mode.

NOTE: CD-R and CD-RW will not play unless the recording session is finalized.

iPod OPERATION

iPod User Interface

The on-screen indicators and touch key areas for iPod playback are outlined below.

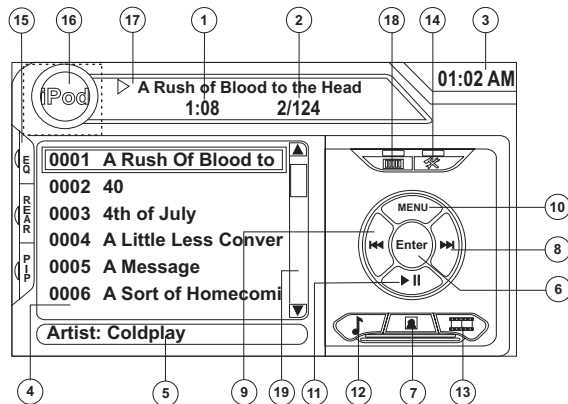

1. Elapsed playing time
2. Current track and total number of files
3. Current time
4. Media titles/menu information
5. ID3 information
6. Enter
7. Touch to access photos
8. >>|: Touch to move to next track
9. |<<: Touch to move to previous track
10. Touch to access the iPod menu
11. >||: Touch to play/pause disc playback
12. Touch to access music files
13. Touch to access video files
14. Touch to access the SETUP screen
15. Touch to view Spectrum Analyzer > Equalizer
16. Touch to view the SOURCE MENU and select a new playback source
17. Song title
18. Touch to view the direct entry menu
19. Touch the scroll bar and arrows to view the previous/next page of songs

Controlling Your iPod

The unit will automatically switch to iPod mode when an iPod is plugged into the MediaLink⁴. To return to the iPod menu from any other source menu, press the **SRC** button (6) on the

front panel or remote control (8) until the iPod menu appears on the screen.

NOTE: Be sure your iPod has the latest Apple firmware installed to avoid connectivity issues.

The following touch screen icons and remote control buttons are used to access the iPod menus:

Menu	Touch Screen	Remote Control
Music		AUDIO
Photos		SUB-TITLE
Videos		ANGLE

Use the touchscreen, the joystick, or the directional keys on the remote control to navigate the iPod menus.

iPod Music Playback

To access iPod music files, touch the button on screen or press the **AUDIO** button (5) on the remote control.

- Touch the > || button on screen to play/pause.
- Touch >>| on screen, press the >>| button (19) on the remote control, or press the > button on the joystick (17) to move to the next item on the menu.
- Touch |<< on screen, press the |<< button (17) on the remote control, or press the < button on the joystick (16) to move to the previous item on the menu.
- Use the touch screen or press the >|| button (18) on the remote control or the joystick **ENTER** button (20) on the control panel to select the highlighted menu option.
- Press the >> button (14) on the remote control or the **Λ** button (18) on the joystick, or touch the **MENU** button on screen to return to the previous menu.

Fast Forward/Fast Reverse

Press and hold the |<< or >>| buttons on screen or on the remote control (17, 19) for 1 second and continue to hold for fast forward or fast reverse. Release to resume normal playback.

Photo Playback

While iPod photos can be viewed on the VM9512 screen, you must use the iPod to control photo playback options.

Touch the icon on screen or press the **SUB-TITLE** button (9) on the remote control to access the iPod PHOTO mode. The VM9512 will release control back to the iPod so you can

select video media to be displayed on the TFT monitor. To exit PHOTO mode, touch the screen.

Video Playback

While iPod video can be viewed on the VM9512 screen, you must use the iPod to control video playback options.

Touch the button on screen or press the **ANGLE** button (13) on the remote control to access iPod VIDEO mode. The VM9512 will release control back to the iPod so you can select video media to be displayed on the TFT monitor. To exit VIDEO mode, touch the screen, press the >> button (14) on the remote control, or press the **MENU** button on the iPod.

NOTE: To transmit the video from your iPod to the VM9512 screen, you must set the following options through the iPod video settings menu: TV Out = On, TV Signal = NTSC, and Widescreen = On.

NOTE: After disconnecting your iPod, the VM9512 will always return to the last mode accessed when the iPod is plugged back into the unit.

Direct Track/File Entry

To select a track/file directly, touch the button on screen control to display the direct entry menu.

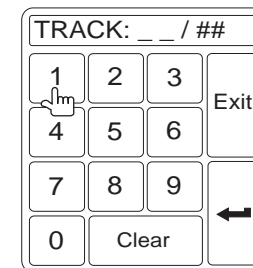

Enter the desired track/file using the on-screen number pad. Press the **Enter** button to tune to the selected station. To exit the screen without changing the station, touch **Exit**. To clear your entry and start over, touch **Clear**.

You can also use the numeric keypad (29) on the remote control to access files directly.

BLUETOOTH OPERATION

About Bluetooth

Bluetooth is a short-range wireless radio connectivity technology that is developed as a cable replacement for mobile phones, handheld PCs and other devices. Bluetooth operates in 2.4 GHz frequency range and transmits voice and data at speeds up to 1 megabit per second. Bluetooth was launched by a special interest group (SIG) comprised of Ericsson Inc., Intel Corp., Nokia Corp., Toshiba and IBM in 1998, and it is currently developed by nearly 2,000 companies worldwide. The Bluetooth word mark and logos are owned by the Bluetooth SIG, Inc. and any use of such marks by Audiovox Corporation is under license. Other trademarks and trade names are those of their respective owners.

NOTE: *The line-of-sight distance between this unit and your cellular phone must be 8 meters or less for sending and receiving voice and data via Bluetooth wireless technology. However, the transmission distance may become shorter than the estimated distance, depending on the environment in use.*

Before attempting to use the Bluetooth functions on the VM9512, please make sure your mobile phone supports Bluetooth functions (Headset or Handsfree profiles or both). Adhere to the following guidelines for successful operation.

- Before using Bluetooth functions, you must pair your mobile phone to the VM9512 head unit (see "Pairing the Bluetooth System with Your Mobile Phone and Head Unit"). To ensure the best reception for pairing and reconnection, please make sure the phone battery is fully charged before you begin.
- Try to perform pairing within a few minutes of the phone being turned on.
- Once the unit has been paired with the phone, the unit's model number, "VM9512", will be displayed on the mobile phone.
- To achieve the best performance, always keep the mobile phone within 3 meters of the head unit.
- Always keep a clear path between the mobile phone and the head unit. Never place a metal object or any other obstacle between the mobile phone and the head unit.
- Some mobile phones (like Sony Ericsson) may have a "Power Saving Mode" option. PLEASE DO NOT use the power saving mode with the VM9512.
- Before accepting or making a call, make sure your mobile phone's "Bluetooth function" is turned on.

- To ensure the best conversation quality/performance, stay within one meter of the head unit when talking.
- To "disconnect" the mobile phone from the head unit, turn the Bluetooth connectivity off on the mobile phone.
- **Phone Book direct searching through the head unit is only available if the mobile phone supports Phone Book Download.** If the feature is not supported, the head unit will display "Phone book not provided by this phone" when an attempt is made to download a phone book.

Bluetooth User Interface

The on-screen indicators and touch key areas for Bluetooth operation are outlined below.

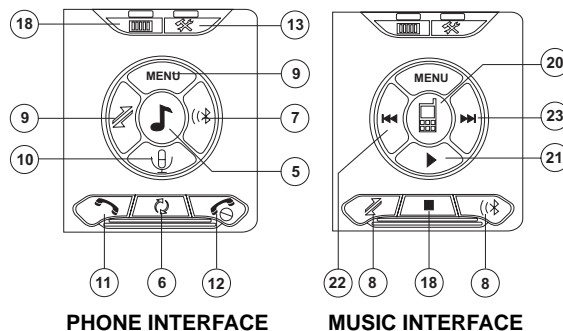
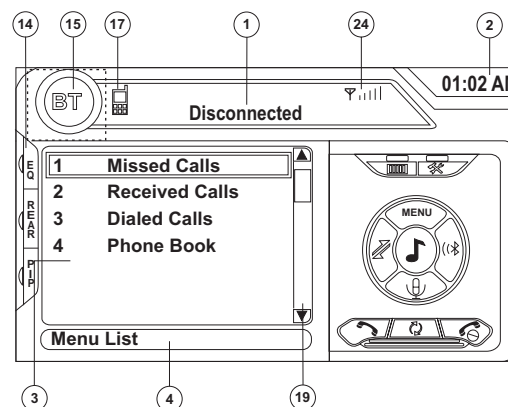

1. Current connection status/device connected
2. Current time
3. Bluetooth menu
4. Current operation status
5. Toggle Music/Phone menu
6. Transfer active call back to handset
7. Pair your Bluetooth phone (first time use)
8. Connect/disconnect Bluetooth device (phone, PDA, personal music player, etc.) with hand-free function
9. Exit call listing display
10. Mute/unmute microphone (located on left side of radio) during active call
11. Answer incoming call/make call
12. Reject incoming call/end call/quit pairing process/quit reading phone book or call listing
13. Touch to view the SETUP menu
14. Touch to view Spectrum Analyzer > Equalizer
15. Touch to view the SOURCE MENU and select a new playback source
16. Indicates connection/current operation (--> indicates incoming call, <-- indicates dialing alert)
17. Touch to access the direct entry screen
18. ■: Touch to stop playback
19. Touch the scroll bar and arrows to view the previous/next page of songs
20. Toggle Music/Phone menu/mode
21. Play/Pause selected file
22. |<<: Touch to move to the previous file
23. >>|: Touch to move to the next file
24. Signal strength indicator

Hands Free Profile (HFP)

To use a phone wirelessly with this unit, it is necessary to first establish a connection using Bluetooth wireless technology. Connection is normally established using HFP (Hands Free Profile), which gives you full control of functions available on the telephone source. However, depending on your phone, the connection may be made using HSP (Head Set Profile), making some functions unavailable. This is a limitation of your phone, not the VM9512.

Since there are a number of Bluetooth mobile phone implementations available on the market, operations with your Bluetooth mobile phone using this unit vary greatly. Please refer to the instruction manual that came with your Bluetooth mobile phone along with this manual while operating your phone with this unit.

Pairing the Bluetooth System with Your Mobile Phone and Head Unit

- Press the (☎) button (8) to initiate the pairing process. Keep the mobile phone within 2 meters of the head unit when pairing. (To terminate the pairing process, press the (☎) button again.)
- Select the Bluetooth setup option on the mobile phone to be paired (please refer to the phone's instruction manual to learn how to enter Bluetooth setup, turn Bluetooth on/off, and perform pairing).

NOTE: Some phones require a "pass key" or pairing code to connect. If your phone requires a pass key or pairing code, you will need to enter this number in the Pairing Code field under the Bluetooth SETUP menu. The default pairing code for many phones is "0000". The default code for the VM9512 is "1234". See "Bluetooth Sub-menu Features" on page 18 for instructions on entering the pairing code.

- Select "VM9512" from the pairing list on the mobile phone.
 - If pairing is successful, the TFT will display the paired mobile phone model number or name (as specified in your phone's Bluetooth Setup menu).
 - If pairing fails, "Phone Pairing Fail" is displayed at the bottom of the screen.

Reconnecting

Once the Bluetooth device has been paired, you can touch the connect (☎) button to reconnect.

NOTE: You can only connect to a phone using the buttons on the on-screen Phone interface.

Each time the (☎) button is pressed, the head unit will automatically reconnect with the mobile phone once (only if the mobile phone was previously paired with the head unit).

Managing Incoming Calls

When connected to a Bluetooth phone, the unit will mute audio output, pause CD play, and change to the Bluetooth screen when a call is received. An incoming phone number will appear at the top of the screen. If the screen is closed, the number will scroll across the LCD. If the incoming call has no caller ID, the TFT or LCD will display "Restricted Number".

Answering an Incoming Call

To answer the call, touch the (☎) button.

For best reception, speak loudly and clearly. The microphone is located on the left side of the unit.

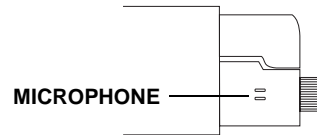

To end the conversation, press the (☎) button. The screen will display the call duration for 3 seconds, and then return to the previous mode.

Rejecting an Incoming Call

Touch the (☎) button to reject an incoming call. The call will revert to your phone and can be answered directly or left for voice mail.

Volume Control

To increase or decrease the volume level, turn the rotary encoder (5) on the front panel or press the VOL+/VOL- buttons (15, 16) on the remote control.

Microphone Mute

To mute the microphone, touch the (🔇) button. Touch again to resume microphone functionality.

Making an Outgoing Call

NOTE: Press the (☎) button from the main Bluetooth screen to automatically dial the last call received.

- Touch the (☎) button to open the direct dial screen.

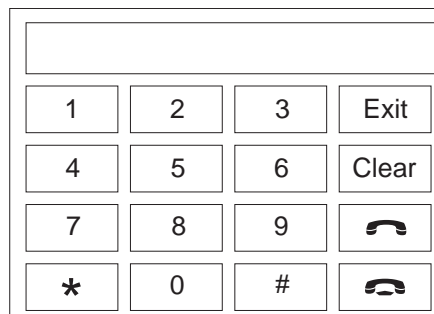

- Use the 0-9, *, and # buttons to input the phone number.
 - Touch the **CLEAR** button to clear the last digit.
 - Touch the (☎) button to clear the entire number and start over.
- After entering the phone number, press the (☎) button to dial the call. The direct dial screen will close once your call is connected.

To end the conversation, press the (☎) button.

Call Transfer

While talking, to transfer audio from the head unit back to the mobile phone, touch the (☎) button (7). The TFT will display "Transfer". You can only transfer a call after it has been answered.

Menu List

The menu list appears on the left side of the screen and can be accessed from other modes by touching the **MENU** button on the right side of the screen.

NOTE: Not all phones allow access to missed, received or dialed calls and some will not allow uploading of your phone's address book.

Missed Calls

The Missed Calls list retrieves the list of Missed numbers from your phone. The last missed number is the first number on the list. Touch the Missed Calls menu option to view the list. To make a call from the Missed Calls list, touch the number and then touch the (☎) button. The TFT will display "Cannot get missed record" when the feature is not available.

Dialed Calls

The Dialed Calls list retrieves the list of dialed numbers from your phone. The last dialed number is the first number on the list. Touch the Dialed Calls menu option to view the list. To make a call from the Dialed Calls list, touch the number and then touch the (☎) button. The TFT will display "Cannot get dialed record" when the feature is not available.

Received Calls

Use the Received Calls list to view the last 10 received numbers stored on your phone. To access the Received list, touch the Received Calls menu option. The last received number is the first number on the list. To make a call from the Received Calls list, touch the number and then touch the (☎) button. The TFT will display "Cannot get received record" when the feature is not available.

Phone Book

1. Touch the Phone Book menu option to display the phone book stored on your mobile phone, if compatible. The screen will display "Ready..." while the phone book is downloading.
2. Once the download is completed, you can use the arrow buttons and scroll bar on the right side of the window to navigate the list. Since the unit downloads one page of entries at a time, there may be a slight delay while the next page of numbers is downloaded.
3. Touch to highlight the number you want to dial and then touch the  button.

NOTE: Some mobile phones do not support Phone Book upload through Bluetooth. This is a limitation of the phone, not the VM9512.

Bluetooth Setup

Auto Answer

You can choose to have the VM9512 automatically answer incoming calls to your paired Bluetooth phone. To turn "Auto answer" on:

1. Touch the  button to view the SETUP menu.
2. Select the "Bluetooth" sub-menu.
3. Touch the area to the right of "Auto answer" to select "On".

Auto Connect

The auto Connect option will allow the VM9512 to automatically connect to your previously paired Bluetooth when it is in range. When the Connect option is set to "Manual", you must press the  button to re-establish a connection with your phone. To turn auto "Connect" on:

1. Touch the  button to view the SETUP menu.
2. Select the "Bluetooth" sub-menu.
3. Touch the area to the right of "Connect" to select "Auto".

Advanced Audio Distribution Profile (A2DP)

The VM9512 allows you to play back audio files from your phone, PDA or personal music player using a Bluetooth connection.

Before using an audio player, it may be necessary to enter a PIN code into the unit. Enter the PIN code referring to "Bluetooth Sub-menu Features" on page 18.

NOTE: Please quit A2DP mode before attempting to make a phone call, as unexpected results may occur depending on your mobile phone model.

The VM9512 can control a Bluetooth audio player via Advanced Audio Distribution Profile (A2DP) or Audio/Video Remote Control Profile (AVRCP). Bluetooth audio players (or Bluetooth adapters) compatible with these profiles can be connected to this unit. Functionality varies depending on the profile used:

- A2DP: Stream audio from your Bluetooth compatible audio player and listen to the music through your VM9512. Play/pause, song selection, etc. are not possible.
- AVRCP: Play back, pause, select songs, etc. while streaming audio from your Bluetooth compatible audio player to the VM9512.

NOTE: Song information (e.g. elapsed playing time, song title, song index, etc.) cannot be displayed on this unit.

Since there are a number of Bluetooth audio players available on the market, operations with your Bluetooth audio player using this unit vary greatly.

Please refer to the instruction manual that came with your Bluetooth audio player as well as this manual while operating your player with the VM9512.

Refer to the MUSIC INTERFACE instructions under "Bluetooth User Interface" on page 32 for information about on-screen indicators and touch screen functions that may be available during audio playback.

TROUBLESHOOTING

Table 7: Troubleshooting

Problem	Cause	Corrective Action
GENERAL		
Unit will not power on	Radio Fuse blown	Install new fuse with correct rating
	Car battery fuse blown	Install new fuse with correct rating
	Illegal operation	Press the RESET button located in the bottom right corner of the front panel
Remote control does not function	Battery depleted	Replace battery with new one
	Battery installed incorrectly	Remove battery and install correctly
No/low audio output	Improper audio output connection	Check wiring and correct
	Volume set too low	Increase volume level
	Improper "MUTE" connection	Review wiring diagram and check "MUTE" connection
	Speakers damaged	Replace speakers
	Heavily biased volume balance	Adjust the channel balance to the center position
	Speaker wiring is in contact with metal part of car	Insulate all speaker wiring connections
Poor sound quality or distortion	Pirated disc is in use	Use original copy
	Speaker power rating not compatible with unit	Connect proper speakers
	Speaker is shorted	Check speaker contact
Tel-Mute malfunction	"MUTE" wire is grounded	Check that the "MUTE" connection is not grounded and that it's properly insulated
Unit resets itself when engine is off	Incorrect connection between ACC and positive battery wire	Check wiring and correct
TFT MONITOR		
Monitor does not open automatically	TFT Auto Open is turned off	Turn TFT Auto Open on
No image	Incorrect connection to parking brake wire	Check wiring and correct
	PRK SW is activated and parking brake is not engaged	Stop vehicle in safe place and apply parking brake
Flashing image or interference appears on screen	DVD is not compatible with current TV system settings	Change setup to accommodate disc
	Improper video signal connections	Check wiring and correct
Prolonged image or improper height/width ratio display	Improper aspect ratio setup	Use correct aspect ratio setting
Monitor stops at incorrect position	Moving path is blocked	Press OPEN key to restart monitor movement
TUNER		
Weak station searching	Auto antenna is not fully extended	Connect the auto antenna control cable properly
	Auto antenna not properly connected	Connect the auto antenna control cable properly
	LOCAL function is activated	Turn LOCAL function off
Cannot insert disc	Disc already inside unit	Eject current disc and insert new one

Table 7: Troubleshooting

Problem	Cause	Corrective Action
Disc does not play back	Disc is warped or scratched	Use disc in good condition
	Disc is dirty or wet	Clean disc with soft cloth
	Laser pickup is dirty	Clean laser pickup with cleaning disc
	Incompatible disc is used	Use compatible disc
	Disc rating exceeds Parental Lock rating limit	Change Parental Lock settings to lower restriction
	Disc region code is not compatible with unit	Use disc with proper region code
	Disc is inserted upside down	Insert disc with label side up
Image blurred, distorted, or dark	Disc is illegally copied	Use original disc
PBC cannot be used during VCD playback	PCB is not available on the disc	
No repeat or searching while playing VCD	PCB is on	Turn PCB off
MP3		
Interruption occurred during playback	Disc is dirty or scratched	Clean disc or replace
	File is damaged/bad recording	Recreate disc with good files
Incorrect playback message displayed	Message is longer than LCD can display	
SAT RADIO		
No Sound	Incorrect cable connections	Check RCA cables
Satellite source not available	Incorrect cable connections	Check Satellite Data cable
IPOD		
iPod source not available	Incorrect cable connections	Check jLink and MediaLink cables
Cannot see video and photo media on TFT screen	Wrong iPod Video Settings	Change iPod video settings to TV Out = On

Error Messages

Table 8: Error Messages

Message Displayed	Cause	Corrective Action
Loading	Disc is being read	
No Disc	Disc is dirty	Clean disc with soft cloth
	Disc is upside down	Insert disc with label side up
	Disc not present in loading compartment	Insert disc
Bad Disc	Disc is dirty	Clean disc with soft cloth
	Disc is upside down	Insert disc with label side up
Unknown disc	Disc format is not compatible with this unit	
Region Error	DVD is not compatible with region code of unit	
Error	Illegal mechanism operation	Press EJECT key for 5 seconds to reset loading mechanism

Care and Maintenance

1. Use only a clean silicone cloth and neutral detergent to clean the front panel or monitor. A rough cloth and non-neutral detergent (such as alcohol) may result in scratching or discoloration.
2. Do not get water or cleaning fluids on the unit.
3. If the temperature inside the player gets too hot, a protective circuit automatically stops play of the disc. If this occurs, allow the unit to cool before operating the player again.
4. Never insert anything other than a 5" (12 cm) disc into the player as the mechanism can be damaged by foreign objects.
5. Do not attempt to use a 3" (8 cm) CD-Single disc in this unit, either with or without an adaptor, as damage to the player and/or disc may occur. Such damage is not covered by the Warranty on this product.
6. The CD player may not operate properly in extreme hot or cold. If such conditions occur, allow the interior of the vehicle to reach a normal temperature before using player.
7. When the vehicle warms up during cold weather or under damp conditions, condensation may appear on the LCD panel. Should this occur, the screen will not operate properly until the moisture has evaporated.
8. We suggest you use a cleaning disc in this unit more frequently than in the unit in your home due to the environmental conditions of the vehicle.

SPECIFICATIONS

DVD/CD Player

Compatible Disc Media: DVD + R / RW (Single and Dual Layer) and CD-R / RW

Compatible Media Formats: CD-DA, MP3, WMA, VCD, SVCD, AVI, MPEG1 / 2, XviD, DivX and Kodak picture CD (JPEG).

Signal to Noise Ratio: >95dBA

Dynamic Range: >95dB

Frequency Response: 20Hz to 20 kHz, -3dB

Channel Separation: > 60dB @ 1 kHz

D/A Converter: High performance 24-bit / 192 kHz sample rate, Multi-Bit Sigma-Delta Modulator

Video

Format: NTSC, PAL (auto-detection)

Output: 1Vp-p (75-ohm)

Input: 1Vp-p (75-ohm)

FM Tuner

Mono Sensitivity (-30dB): 9dBf

Quieting Sensitivity (-50dB): 15dBf

Alternate Channel Selectivity: 70dB

Signal to Noise Ratio @ 1 kHz: 58dB

Image Rejection: 80dB

Stereo Separation @ 1 kHz: >30dB

Frequency Response: 30Hz - 15 kHz, -3dB

AM Tuner

Sensitivity (-20dB): 15uV

Signal to Noise Ratio @ 1 kHz: 50dB

Image Rejection: 60dB

Frequency Response: 50Hz - 2 kHz, -3dB

Monitor

Screen Size: 7.0" (Measured diagonally), 16:9 Widescreen

- 6.06" (154.1mm) W X 3.42" (87mm) H

Screen Type: TFT Liquid Crystal Display (LCD) active matrix

Response Time: 30mSec rise time, 50mSec fall time

Resolution:

- 336,960 sub pixels, 1440 (W) X 234 (H)

Viewing angle:

- 65 degrees left or right
- 40 degrees up
- 65 degrees down

General

Auxiliary Input Impedance: 10k-ohm

Power Supply: 11 to 16VDC, negative ground

Power Antenna (Blue): 500mA max, current limited protection

Amplifier Remote (Blue/White): 500mA max, current limited protection

Operating Temperature: -20C ~ 65C

Fuse: 15-amp, mini ATM type

DIN chassis dimensions: 7" X 7" X 2" (178mm x 178mm x 50mm)

CEA Power Ratings



Power Output: 18 Watts RMS x 4 channels into 4-Ohms @ < 1% THD+N

Signal to Noise Ratio: 70dBA below reference (Reference: 1 Watt, 4-Ohms)

Frequency Response: 20 Hz - 20 kHz, -3dB. (Aux Input used as reference input)

Reference Supply Voltage: 14.4VDC

**Specifications subject to change without notice.*

Limited Warranty

CD or Multimedia Radios/Headunits

DO NOT RETURN THIS PRODUCT TO THE STORE

Audiovox Electronics Corporation (“the Company”) is committed to quality and customer service, and are pleased to offer you this Warranty. Please read it thoroughly and contact the Company at 1-800-323-4815 with any questions.

Who is covered?

The Company extends this warranty to the original retail purchaser of products purchased through an authorized Audiovox retailer in the U.S.A., Puerto Rico or Canada. This warranty is not transferable or assignable. Proof of purchase is required in the form of an original sales receipt.

What is covered?

The Company warrants that should this product or any part thereof, under normal use, be proven defective in material or workmanship within 12 months from the date of original purchase, such defect(s) will be repaired or replaced with a new or reconditioned product (at the Company's option) without charge for parts and repair labor.

What is not covered?

This Warranty *does not* cover the following:

- Damage incurred during shipping or transporting the product to the Company or a service center
- Elimination of car static or motor noise
- Defects in cosmetic, decorative or non-operative structural parts
- Correction of antenna problems
- Costs incurred for installation, removal or reinstallation of the product
- Consequential damage to compact discs, USB devices, digital media cards, accessories or vehicle electrical systems
- Damage caused by improper installation, mishandling, misuse, neglect, accident, blown fuse, battery leakage, theft or improper storage
- Products whose factory serial number/bar code label(s) or markings have been removed or defaced
- Damage resulting from moisture, humidity, excessive temperature, extreme environmental conditions or external natural causes

Please review the “Care and Maintenance” section of your Installation and Operation Manual for additional information regarding the proper use of your product.

Limitations

THE EXTENT OF THE COMPANY'S LIABILITY UNDER THIS WARRANTY IS LIMITED TO THE REPAIR OR REPLACEMENT PROVIDED ABOVE AND, IN NO EVENT, SHALL THE COMPANY'S LIABILITY EXCEED THE PURCHASE PRICE PAID BY PURCHASER FOR THE PRODUCT.

This Warranty is in lieu of all other express warranties or liabilities. ANY IMPLIED WARRANTIES, INCLUDING ANY IMPLIED WARRANTY OF MERCHANTABILITY, SHALL BE LIMITED TO THE DURATION OF THIS WRITTEN WARRANTY. ANY ACTION FOR BREACH OF ANY WARRANTY HEREUNDER INCLUDING ANY IMPLIED WARRANTY OF MERCHANTABILITY MUST BE BROUGHT WITHIN A PERIOD OF 24 MONTHS FROM DATE OF ORIGINAL PURCHASE. IN NO CASE SHALL THE COMPANY BE LIABLE FOR ANY CONSEQUENTIAL OR INCIDENTAL DAMAGES FOR BREACH OF THIS OR ANY OTHER WARRANTY, EXPRESS OR IMPLIED, WHATSOEVER. No person or representative is authorized to assume for the Company any liability other than expressed herein in connection with the sale of this product.

Some states do not allow limitations on how long an implied warranty lasts or the exclusion or limitation of incidental or consequential damage so the above limitations or exclusions may not apply to you. This Warranty gives you specific legal rights and you may also have other rights which vary from state to state.

Obtaining Warranty Service

- To obtain repair or replacement within the terms of this Warranty, call 1-800-323-4815 for the location of a warranty station serving your area.
- You must prepay the initial shipping charges to the Company. The Company will pay the return shipping charges for all warranted products returned to an address within the U.S.A., Puerto Rico or Canada.
- Please package the product securely to avoid shipping damage. We recommend using a carrier that provides tracking service to prevent lost packages. Lost or damaged packages are not covered by this warranty.
- Provide a detailed description of the problem(s) for which you require service.

if it's too
LOUD
you're too
OLD!



Audiovox Electronics Corporation
Hauppauge, NY 11788
Technical Assistance: 1-800-323-4815
www.jensen.com

© 2007 Audiovox
Ver. 070607
Printed in China

Free Manuals Download Website

<http://myh66.com>

<http://usermanuals.us>

<http://www.somanuals.com>

<http://www.4manuals.cc>

<http://www.manual-lib.com>

<http://www.404manual.com>

<http://www.luxmanual.com>

<http://aubethermostatmanual.com>

Golf course search by state

<http://golfingnear.com>

Email search by domain

<http://emailbydomain.com>

Auto manuals search

<http://auto.somanuals.com>

TV manuals search

<http://tv.somanuals.com>