



MP6312i

Instruction Manual



INTRODUCTION

Congratulations on your purchase of the Jensen MP6312i Mobile Receiver. It's a good idea to read all of the instructions before beginning the installation. We recommend having your Jensen MP6312i installed by a reputable installation shop.

Features

CD / MP3 / WMA

- ID3 Tag Compatible
- Last Position Memory
- Directory Search (MP3 / WMA Only)
- MP3/WMA search by Track, File and Character
- Audible Forward / Reverse Track Search
- Random, Repeat and Intro
- Play, Pause, Stop, Next Track and Previous Track
- ESP Buffer (Electronic Shock Protection)

AM-FM

- RDS - Radio Data Service
- USA / Europe Frequency Spacing
- 30 Station Presets (18 FM / 12 AM)
- Auto Stereo / Mono
- Local / Distant Reception
- Auto Store / Preview Scan

Sat Radio Ready

- Compatible with XM and Sirius Tuners (Sold Separately)
- Requires XMDJEN100 and JXMC Cables (Sold Separately)

iPod Ready

- Made for iPod
- Access Playlists, Artist, Albums and Songs
- Requires JLink iPod Cable (Sold Separately)

MediaLink

- Under dash Interface allows Portable Media Devices to be connected
- MediaLink1 includes the following connectivity:
 - jLinkDirect 8-pin DIN for iPod
 - 3.5mm audio only Input

Chassis

- Detachable Faceplate
- 1.0 DIN (Import / ISO-DIN Mountable)
- 8 Character / Segment Type LCD Display

- Chassis Mounted Rear Auxiliary Inputs

General

- Infrared Remote Control
- Programmable Volume Control
- Three Preset EQ Curves
- Loudness
- Rotary Encoder Audio Control
- 12/24 Hour Clock
- Beep Tone Confirmation (On-OFF Option)
- Front and Rear Line Outputs
- 200-Ohm Preamp Line Outputs
- 2VRMS Line Outputs

INSTALLATION

This unit is designed for installation in cars, trucks and vans with an existing radio opening. In many cases, a special installation kit will be required to mount the radio to the dashboard. These kits are available at electronics supply stores and car stereo specialty shops. Always check the kit application before purchasing to make sure the kit works with your vehicle. If you have trouble locating a kit or need installation assistance, contact Technical Support at 1-800-323-4815 from 9:00am to 6:00pm EST Monday through Friday.

Tools and Supplies

The following tools and supplies are needed to install the radio:

- Torx type, flathead and Philips screwdrivers
- Wire cutters and strippers
- Tools to remove existing radio (screwdriver, socket wrench set or other tools)
- Electrical tape
- Crimping tool
- Volt meter/test light
- Crimp connections
- 18 gauge wire for power connections
- 16-18 gauge speaker wire

Preparation

1. Disconnect Battery

Before you begin, always disconnect the battery negative terminal.

NOTE: If the MP6312i is to be installed in a car equipped with an on-board drive or navigation computer, do not disconnect the battery cable. If the cable is disconnected, the computer memory may be lost. Under these conditions, use extra caution during installation to avoid causing a short circuit.

2. Remove Transport Screws

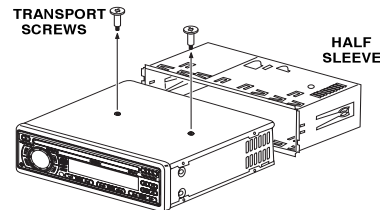

3. Remove Radio from Sleeve

Lift latches on both sides of sleeve to remove half-sleeve from radio.

Mounting Sleeve Installation

1. Slide the mounting sleeve off the chassis. If it is locked into position, use the removal tools (supplied) to disengage it.
2. Check the dashboard opening size by sliding the mounting sleeve into it.

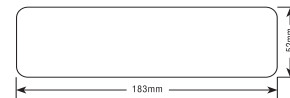

If the opening is too small, carefully cut or file as necessary until the sleeve easily slides into the opening. Do not force the sleeve into the opening or cause it to bend or bow. Check for sufficient space behind the dashboard for the radio chassis.

3. Locate the series of bend tabs along the top, bottom, and sides of the mounting sleeve. With the sleeve fully inserted into the dashboard opening, bend as many of the tabs outward as necessary to firmly secure the sleeve to the dashboard.

CAUTION: For proper operation of the CD player, the chassis must be mounted within 20° of horizontal. Make sure the unit is mounted within this limitation.

- Place the radio in front of the dashboard opening so the wiring can be brought through the mounting sleeve. Follow the wiring diagram carefully and make certain all connections are secure and insulated with wire nuts or electrical tape. See "Wiring" on page 5. After completing the wiring connections, turn the unit on to confirm operation (vehicle ignition must be on). If the unit does not operate, re-check all wiring until the problem is corrected.
- Make sure the radio is right-side up, then carefully slide the radio into the mounting sleeve until it is fully seated and the spring clips lock it into place.
- Secure the rear of the unit to the car body using the mounting bolt and rubber cushion.
- Test the radio using the Operating Instructions that follow.

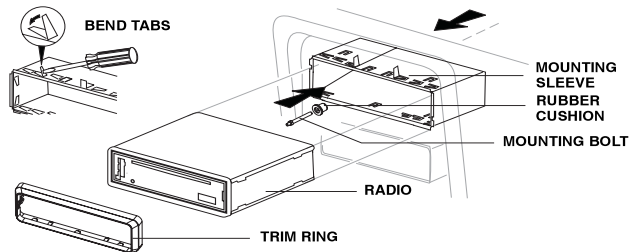
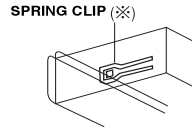

Kit Installation

If your vehicle requires the use of an installation kit to mount this radio, follow the instructions included with the installation kit to attach the radio to the mounting plate supplied with the kit.

- Wire and test the radio as outlined in the Mounting Sleeve Installation instructions.
- Install the radio/mounting plate assembly to the sub-dashboard according to the instructions in the installation kit.
- Attach the support strap to the radio and dashboard as described in the Universal Installation instructions.
- Replace the dashboard trim panel.

ISO Installation

This unit has threaded holes in the chassis side panels which may be used with the original factory mounting brackets of some vehicles to mount the radio to the dashboard. Please consult with your local car stereo shop for assistance on this type of installation.

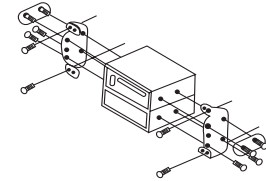

- Remove the existing factory radio from the dashboard or center console mounting. Save all hardware and brackets as they will be used to mount the new radio.
- Carefully unsnap the plastic frame from the front of the new radio chassis. Remove and discard the frame.
- Remove the factory mounting brackets and hardware from the existing radio and attach them to the new radio. Do not exceed M5 x 9 MM maximum screw size. Longer screws may damage components inside the chassis.
- Wire the new radio to the vehicle as outlined in the Universal Installation instructions.
- Mount the new radio assembly to the dashboard or center console using the reverse procedure of step 1.

Fuses

When replacing a fuse, make sure the new fuse is the correct type and amperage. Using an incorrect fuse could damage the radio.

Reconnect Battery

When wiring is complete, reconnect the battery negative terminal.

Removing the Radio

To remove the radio after installation, remove the trim ring by lifting in the center and pulling it off from either side. Insert the removal keys straight back until they lock, then pull the radio out. If removal keys are inserted at an angle, they will not lock properly and will not release the unit.

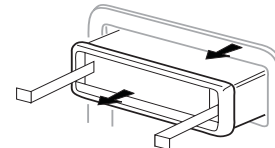

Technical Assistance

If you require assistance, contact Technical Support at 1-800-323-4815 from 9:00am to 6:00pm EST Monday through Friday.

WIRING

NOTE: The amplifier in this radio is only designed for use with four speakers. Never combine (bridge) outputs for use with two speakers. Never ground negative speaker leads to chassis ground. Failure to wire exactly as shown may cause electrical damage to the radio.

NOTE: Only connect speakers with a nominal impedance of 4 ohms. Speakers with a load impedance less than 4 ohms could damage the unit.

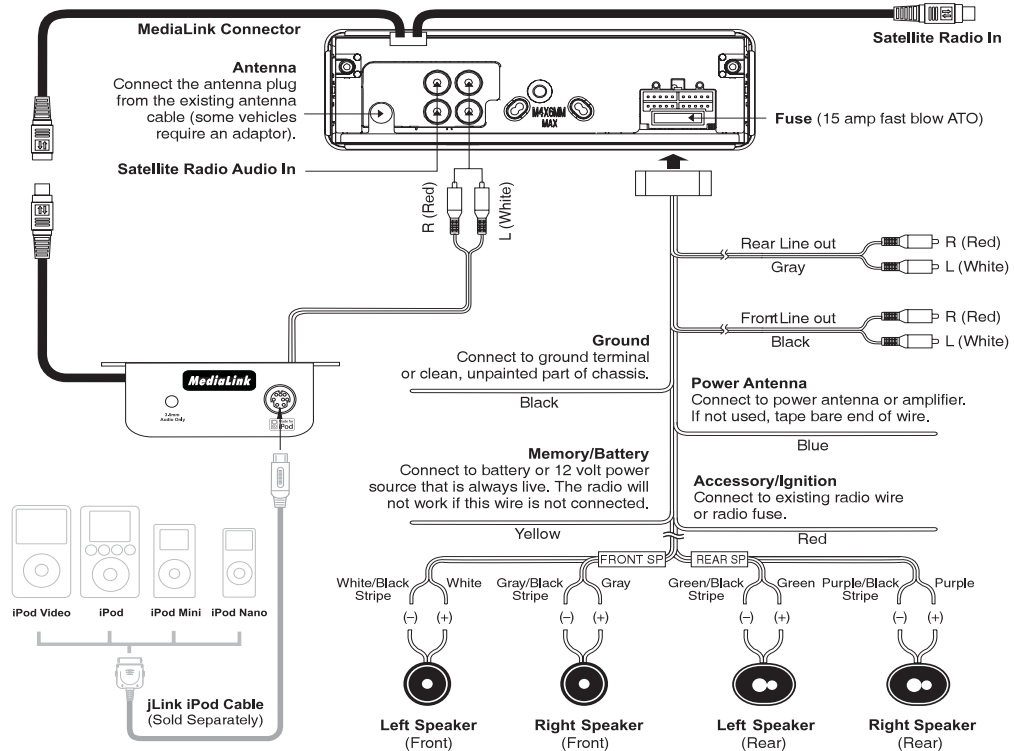

FRONT PANEL RELEASE

The front panel release button (4) releases the mechanism that holds the front panel to the chassis.

Detaching the Front Panel

To detach the front panel, first press the front panel release button to release the left side of the panel. Next, grasp the released side and pull it off the chassis. After removing the front panel, store it in the supplied carrying case to protect it from dirt and damage.

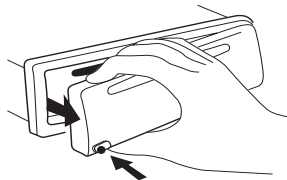

Re-attaching the Front Panel

To re-attach the front panel, make sure the electrical terminals on the back of the panel are free of dust and dirt, as debris could cause intermittent operation or other malfunctions. Position the right side of the panel in place until correctly engaged, then lightly press the left side of the panel until the mechanism locks it into place.

OPERATION

Power

Press the power button (2) to turn the unit on. *Press and hold* the power button again to turn the unit off.

NOTE: LCD panels may take longer to respond when subjected to cold temperatures for an extended period of time. In addition, the visibility of the numbers on the LCD may decrease slightly. The LCD display will return to normal when the temperature increases to a normal range.

Source

Press the SRC button (6) to select a different mode of operation, as indicated on the display panel. Available modes include tuner (FM1, FM2, FM3, AM1, AM2), CD, auxiliary (AUX), SAT and iPod. CD, SAT and iPod mode only appear when the source is available.

Audio Mute

Press the mute button (2) to silence the audio volume. "Mute" appears on the display. Press mute button (2) again to restore volume to the previous setting.

Volume / Audio Control

To increase the volume, turn the rotary encoder (5) clockwise. To decrease the volume, turn the rotary encoder counter-clockwise. When volume is adjusted, the volume level will be shown on the display panel as a number ranging from "0" (lowest) to "46" (highest).

Press the MENU button (5) repeatedly to step through the following audio functions: bass (BAS), treble (TRE), balance (BAL), fader (FAD) and volume (VOL). The unit automatically exits audio control mode after five seconds of inactivity.

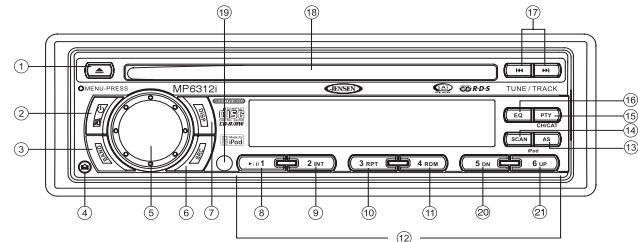
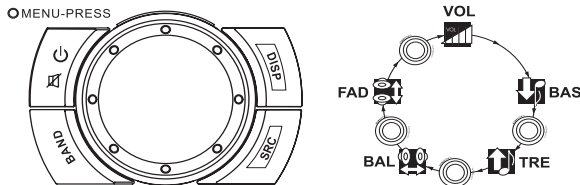

Bass

To adjust the bass level from "-6" to "+6", press the MENU button (5) until "BAS" appears in the display. Turn the rotary encoder clockwise to increase or counter-clockwise to decrease the bass. "0" represents a flat response.

Treble

To adjust the treble level from "-6" to "+6", press the MENU button until "TRE" appears in the display. Turn the rotary encoder clockwise to increase or counter-clockwise to decrease the treble. "0" represents a flat response.

Balance

To adjust the balance from "12L" (full left) to "12R" (full right), press the MENU button until "BAL" appears in the display. Turn the rotary encoder to adjust the balance between the left and right speakers. "L = R" represents a center balance.

Fader

To adjust the fader from "12F" (full front) to "12R" (full rear), press the MENU button until "FAD" appears in the display. Turn the rotary encoder to adjust the fader between the front and rear speakers. "F = R" represents a center fader level.

Equalizer Selector

The equalizer function applies preset sound effects to the unit's audio output signal. Press **EQ** (16) to step through the following equalizer options: "ROCK", "HIP-HOP", "DANCE", and "EQ OFF".

When the equalizer function is activated, the most recently selected bass/treble levels cannot be adjusted. When the equalizer function is not active, the unit will return to the most recently selected bass and treble levels.

Menu Operation

Press and hold the **MENU** button (5) for more than two seconds to access the menu. Press the **MENU** button to move through the following menu options: LOUD ON/OFF, 12/24 HOUR, VOL LAST/VOL ADJ, BEEP ON/OFF, AREA SET, LO/DX. The following procedures assume you have already accessed the menu.

Loudness On/Off

When listening to music at low volume levels, this feature will boost the bass and treble ranges to compensate for the characteristics of human hearing. To change the loudness setting:

1. Press the **MENU** button (5) to select the "LOUD" feature.
2. Turn the rotary encoder (5) to select "ON" or "OFF".

When activated, "LOUDNESS" appears on the display panel.

12/24 Hour Time Format

This option allows selection of a 12 hour or 24 hour clock format. "12 HOUR" is the default setting. Turn the rotary encoder to change to the 24 hour clock format.

Programmable Turn-on Volume Level

Press the **MENU** button (5) to select "VOL LAST" or "VOL ADJ".

- VOL LAST: When the unit is turned on, the volume will resume at the level selected when last turned off.
- VOL ADJ: After selecting "VOL ADJ", turn the rotary encoder (5) to select the desired level. When this option is selected, the unit will revert to the adjusted volume each time the unit is turned on.

Beep Tone

The beep tone feature allows the selection of an audible beep tone to be heard each time a button is pressed on the face of the radio. "BEEP ON" is the default setting.

To turn the audible beep off:

1. Press the **DISP** button to select "BEEP ON".
2. Turn the rotary encoder to select the "BEEP OFF" option.

Frequency Spacing

This option allows you to select the appropriate frequency spacing for your area. "U.S.A." is the default setting. Turn the rotary encoder to select "EUROPE".

Local/Distant Reception (LO/DX)

When the Local function is on, only radio stations with a strong signal are played.

To activate Local reception mode:

1. Press the **MENU** button (5) to select "DX" (If Local is already activated, "LO" appears in the menu instead of "DX").
2. Turn the rotary encoder (5) to select "LO".

NOTE: Distant mode is indicated by a triangle with circles above it.

Clock Set

1. Press the **DISP** button (7) to display the clock.
2. Press and hold the **DISP** button until the clock blinks.
3. Turn the rotary encoder (5) to the right to set the hour and to the left to set the minutes.

Reset Button

The **RESET** button is located on the front of the chassis and can only be accessed with the front panel removed. The reset circuitry protects the microprocessor circuitry. Since resetting the unit will erase the time and preset memories, it should only be activated upon initial installation after all wiring is complete, or if there is a malfunction of any of the switches on the unit. In these circumstances, pressing the **RESET** button will clear the system and return the unit to normal operation.

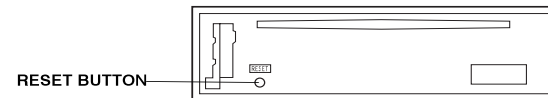

TUNER OPERATION

The MP6312i allows you to receive channels in U.S.A. or EUROPE mode. See "Frequency Spacing" on page 8 to learn how to change the tuner options.

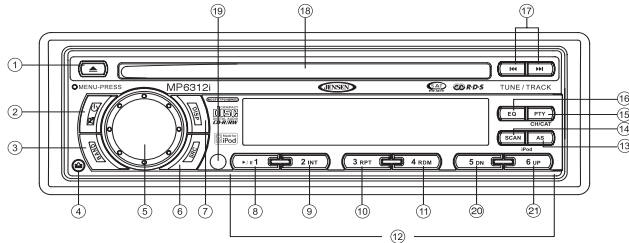

Select a Band

Press the **BAND** button (3) to change between three FM and two AM bands. Each band stores up to six preset stations.

Tuning

Auto Seek Tuning

Press the **TUNE/TRACK >>|** or **|<<** buttons (17) to move to the next/previous station automatically.

Manual Tuning

Press and hold the **TUNE/TRACK >>|** or **|<<** buttons (17) for more than three seconds to enter manual tuning mode. Next, press the **>>|** or **|<<** buttons to move the radio frequency number up or down one step.

Preset Stations

Up to six stations on each band can be stored as presets, which can then be instantly recalled by pressing the associated preset button (12). To store a station, turn the radio on and select the desired band and station. Press and hold the desired preset button (numbered one through six on the face of the radio) for more than two seconds. When stored, the preset number will appear in the display. The station is now stored and can be recalled by pressing the corresponding preset button. Repeat for the remaining five presets on the current band and for presets on the other four bands.

Preview Scan

Press the **SCAN** button (14) to scan all strong stations in the current band. The unit will stop at each station for five seconds before continuing to the next station. Press **SCAN** again to stop scanning and listen to the current station.

Automatic Store (AS)

Select six strong stations and store them in the current band using the Automatic Store feature. To enable this feature, press the **AS** button (13). The radio will automatically scan the band in use and enter strong stations into the preset memory positions for that band. After entering the stations into memory, the unit will automatically stop at each station for five seconds, allowing you to preview each selection. When using the Automatic Store feature, the new stations replace any stations already stored in preset memory for the selected band.

Program Type (PTY)

PTY defines the type of program being broadcast, when applicable. Not all stations are broadcast with PTY information. You can use the PTY function to play stations broadcast in the following categories:

- All PTY (any station with PTY information is searched)
- Traffic (the **TA** (Traffic Announcement) icon appears lit when a station broadcasting PTY Traffic Reports is selected)
- News
- Information
- Sports
- Talk
- Rock
- Classic Rock
- Adult Hits
- Soft Rock
- Top 40
- Country
- Oldies
- Soft
- Nostalgia
- Jazz
- Classical
- Rhythm and Blues
- Soft Rhythm and Blues
- Language

- Religious Music
- Religious Talk
- Personality
- Public
- College
- Weather
- Emergency Test
- Emergency

To search for stations in a PTY category:

1. Press the **PTY** button (15) to view the current PTY category.
2. Use the **TUNE/TRACK >>|** or **|<<** buttons (17) to move through the list of available categories.
3. After 2 seconds of inactivity, the radio will automatically scan and play the first station it locates in the selected category.

NOTE: PTY is a new broadcast technology that may not be extensively available in your area.

CD PLAYER OPERATION

Insert and Eject CD

Insert a CD, label side up. To stop CD play and eject the CD, press the eject button (1).

NOTE: The unit is designed for play of standard 5" (12 cm.) compact discs only. Do not attempt to use 3" (8 cm.) CD singles in this unit, either with or without an adaptor, as damage to the player and/or the disc may occur. Such damage will not be covered by the warranty on this product.

Pause

Press the pause >|| button (8) to suspend disc play. Press the pause >|| button again to resume disc play.

Track Select

Press the TUNE/TRACK >>| or |<< buttons (17) for less than one second to advance to the next track on the CD. The selected track number will appear on the display. Press and hold the TUNE/TRACK >>| or |<< buttons (17) to fast forward or fast reverse through the disc. CD play starts when the button is released.

Intro Scan (INT)

During disc play, press the INT button (9) to select "INT ON" and play the first 10 seconds of each track on the disc. When the desired track is reached, press INT again to end the scan and play the selected track.

Repeat (RPT)

Press the RPT button (10) during disc play to select "RPT ON" and continuously repeat the track. Press RPT again to stop repeating.

Random (RDM)

Press the RDM button (11) during disc play to select "RDM ON" and play all tracks on the CD in random, shuffled order. Press RDM again to stop random play.

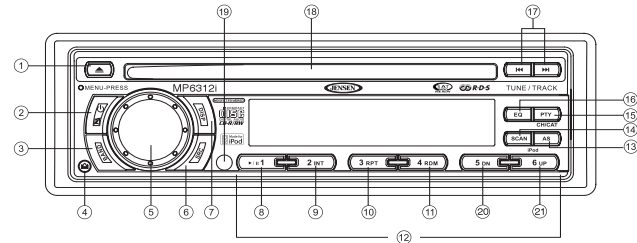

CD Player Error Codes

If a problem should develop while operating the CD player, an error code may appear on the display panel. This can indicate a number of problems with the unit, including a mechanical error or an error in the microprocessor control. If an error code appears, try ejecting and reloading the disc into the player. While the disc is out of the unit, make sure it is clean and undamaged, and then load it correctly. If this does not solve the problem, pressing the **RESET** button may help, but will erase the time and preset memory. If the suggested measures do not solve the problem, contact an approved warranty station near you for further assistance.

MP3/WMA OPERATION

MP3 and WMA (Windows Media Audio) music files are digital audio files that are compressed to allow more files on a single CD. This unit can play MP3/WMA directly from files contained on a CD-R/RW using the buttons on the receiver (or optional remote control) as described below. Many types of software are available for converting audio files into MP3/WMA formats. Jensen recommends *Nero* or *Roxio Easy CD Creator*. Depending on the media type and recording method, some CD-R/RWs may be incompatible with this unit. This unit supports playback of MP3/WMA and CDDA (CDA), Mixed-Mode CDs and CD-Extra (including multi-session discs). Discs on which the session has not been closed will not play.

Notes on MP3/ WMA Play

This unit can play MP3 (MPEG1, 2, 2.5 Audio Layer 3). However, the MP3 recording media and accepted formats are limited. When writing MP3/WMA, pay attention to the following restrictions.

Acceptable Media

The MP3/WMA recording media acceptable to this unit are CD-ROM, CD-R and CD-RW. When using CD-RW, use full format rather than quick format to prevent malfunction.

Acceptable Medium Formats

The following formats are available for the media used in this unit. The maximum number of characters used for file name including the delimiter (".") and three-character extension are indicated in parentheses.

- ISO 9660 Level 1 (11 characters)
- ISO 9660 Level 2 (31 characters)
- Joliet (31 characters)
- Romeo (31 characters)

Up to 200 characters can be displayed in the long file name format. For a list of available characters, see the instruction manual of the writing software and the section "Entering File and Folder Names" below. The media reproducible on this unit has the following limitations:

- Maximum number of nested folders: 8
- Maximum number of files per disc: 999
- Maximum number of folders per disc: 255

MP3/WMA files written in formats other than those listed above will not play successfully and their file or folder names will not display properly.

MP3/WMA Encoder and CD Writer Settings

Use the following settings when compressing audio data with the MP3 encoder.

- Transfer bit rate : 8 - 320 kbps
 - Sampling frequency: 8, 11.025, 12, 16, 22.05, 24, 32, 44.1, 48 kHz
- When using a CD writer to record MP3/WMA up to the maximum disc capacity, disable additional writing. To record an empty disc up to the maximum capacity at once, select the "disc at once" option.

Entering ID3 Tag

This unit supports ID3 tag versions 1.0 and 1.1. For character codes, refer to the table to the right.

Entering File and Folder Names

Names using the code list characters are the only file names and folder names that can be entered and displayed. Using any other character will cause the file and folder names to be displayed incorrectly. The unit recognizes and plays only files with the MP3/WMA extension.

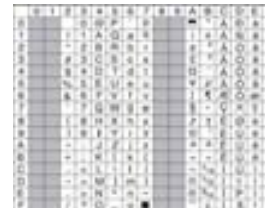

NOTE: A file name entered with characters not on the code list may not play correctly.

Writing Files into a Medium

When a medium containing MP3/WMA data is loaded, the unit checks all data. If the medium contains a large number of folders or non-MP3/WMA files, MP3/WMA play will be delayed, it may take time for the unit to move to the next file, and searches may not be performed smoothly. Loading such a medium may produce loud noise and cause damage to the speakers. **Do not attempt to play a medium containing a non-MP3/WMA file with the MP3/WMA extension or a medium containing non MP3/WMA files.**

Electronic Shock Protection

- 10 seconds for CD-DA (CDA)
- >45 seconds for MP3 recorded at 44.1kHz, 128kbps
- >90 seconds for WMA recorded at 44.1kHz, 128kbps

Bit Rates

The unit supports bit rates from 32 - 320 kbps.

MP3 Playing Order

When selected for play, files and folders (Folder Search, File Search or Folder Select) are accessed in the order they were written by the CD writer.

As a result, the order in which they are expected to be played may not match the order in which they are actually played. You may be able to set the order in which MP3/WMA files are to be played by writing them onto a medium such as a CD-R with their file names beginning with play sequence numbers such as "01" to "99". For example, a medium with the following folder/file hierarchy is subject to Folder Search, File Search or Folder Select as shown below.

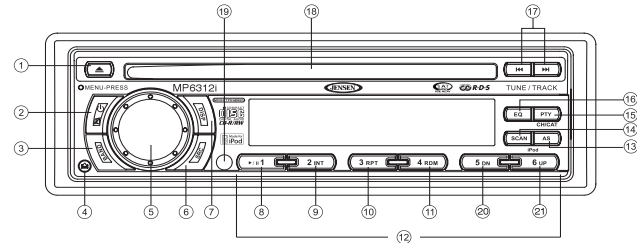

The MP6312i player will only recognize three folder levels and does not display folders containing only other folders. In the example above, the unit will display folders 3, 4, 6, and 8, but not 2 and 7 since they do not contain any tracks directly. Folder 5 is not recognized at all since it is at the fourth level.

Loading an MP3/WMA Disc



After the disc is loaded, "CD Read" is displayed then "MAX" followed by the number of tracks is displayed. The unit will then display ID3 information pertaining to the last selected category (Folder, File, Track, Artist, Album, or Track number and Elapsed time).

Pause

Press the pause >|| button (8) to suspend disc play. Press the pause >|| button again to resume disc play.

Accessing the ID3 Tag

Press the DISP button (7) repeatedly during MP3/WMA play to access the ID3 information manually. The display will show any of the following information that is programmed on the disc: Folder Name, File Name, Track Title, Artist Title, Album Name.

ICON	DESCRIPTION
	FOLDER ICON
	FILE ICON
	TRACK ICON
	ARTIST ICON
	ALBUM ICON

Track Select

Press the TUNE/TRACK >>| or |<< buttons (17) for less than one second to advance to the next track on the disc, or for more than one second to fast forward or fast reverse through the track. Disc play starts when the button is released.

Navigating Folders

Press the folder **UP** (21) button (also the "5" button) to advance 10 songs. Press the folder **DN** (20) button (also the "6" button) to move 10 songs in reverse.

Press and hold the folder **UP** button to skip to the next folder or the folder **DN** button to return to the previous folder.

Intro Scan (INT)

- Press the **INT** button (9) once to select "INT ON" and play the first 10 seconds of each track on the disc.
- Press **INT** twice to select "INT FOLDER" and play the first 10 seconds of each track in the current folder.
- To turn off intro scan and play the current track, press the **INT** button until "INT OFF" appears on the display.

Repeat (RPT)

- Press the **RPT** button (10) once to select "RPT ON" and repeatedly play the current file.
- Press **RPT** twice to select "RPT FOLDER" and repeatedly play all files in the current folder.
- To turn off repeat play, press the **RPT** button until "RPT OFF" appears on the display.

Random (RDM)

- Press the **RDM** button (11) once to select "RDM ON" and randomly play all files on the disc.
- Press **RDM** twice to select "RDM FOLDER" and randomly play all files in the current folder.
- To turn off random play, press the **RDM** button until "RDM OFF" appears on the display.

MP3/WMA File or Folder Search

The unit offers three methods of searching for files or folders on a disc.

Direct Track Search

1. Press the **AS** button (13) to activate the Track Search function. The LCD will display "TRK SCH".
2. Press the **MENU** button (5) to confirm.
3. Turn the rotary encoder (5) to select the third digit.
4. Press **MENU** to confirm and move to the second digit position.
5. Turn the rotary encoder to select the second digit.
6. Press **MENU** to confirm and move to the first digit position.
7. Turn the rotary encoder to select the first digit.
8. Press **MENU** to confirm and play the selected track.

Navigation Search

1. Press the **AS** button (13) twice. The LCD will display "Navigate".
2. Turn the rotary encoder (5) to navigate through all folders and sub-folders on the disc. The folder names will be displayed on the LCD.
 - Press the **MENU** button (5) for more than three seconds to play the first file in the folder.
 - Press **MENU** for less than three seconds to access the sub-folders or files.
- Turn the rotary encoder to navigate, then press the select knob to confirm and begin file play.
- During navigation search, turn the rotary encoder to the left to move back to the last upper level of a folder.

Direct Character Search

1. Press the **AS** button (13) three times. The LCD will display "CHAR - SCH".
2. Turn the rotary encoder (5) to choose a character, including letters A-Z, numbers 0-9 and blank spaces.
3. Press the **MENU** button (5) to confirm entry and move to the next character space. After the last character is entered, *press and hold* the **MENU** button to begin the search.
4. If only two characters are entered and there is more than one file that begins with these characters, turn the rotary encoder to navigate the files or folders.
5. Press **MENU** to confirm and play the file.

SATELLITE RADIO OPERATION

Listeners can subscribe to XM[®] Radio on the Web by visiting www.xmradio.com, or by calling (800) 967-2346. Customers should have their Radio ID ready (see "Displaying the Identification (ID) Code"). Customers can receive a limited number of free-to-air channels without activation.

Listeners can subscribe to Sirius[®] Radio on the Web by visiting www.sirius.com, or by calling (888) 539-SIRIUS. Customers should have their Sirius ID ready (Sirius ID is located on the Satellite Radio Tuner, sold separately). Customers can listen to music samples by tuning to channel 184.

Accessing Satellite Radio Mode

To switch to Satellite Radio mode, press **SRC** (2) until "- - SAT - -" appears on the display. This will not be displayed unless the unit is connected to an optional XM or Sirius receiver.

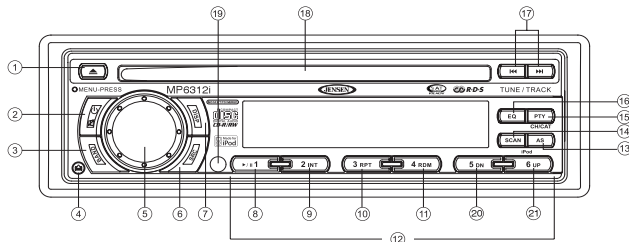

Displaying the Identification (ID) Code

Before you listen to Satellite Radio, you must subscribe to the service using your radio's identification number. To display the radio ID, press the **TUNE/TRACK** <<| button (17) to access channel 000. The screen displays "RADIO ID" followed by the ID number.

Selecting a Station

Press the **TUNE/TRACK** >>| or <<| button (17) to change to another station. Press and hold the **TUNE/TRACK** >>| or <<| button for more than one second to fast forward or fast reverse through the stations.

Preset Stations

Press the **BAND** button (3) to change between three SAT Radio bands. Each band stores up to six preset stations. You can store and recall a total of 18 preset stations.

Store a Station

1. Select a band (if needed), then select a station.
2. Hold a preset button (12) for three seconds. The preset number appears in the display.

Recall a Station

1. Select a band (if needed).
2. Press a preset button (12) to select the corresponding stored station.

Tuner Modes

Press the **DISP** button (7) to change the tuner mode to the following options in the order listed.

- Channel Name
- Genre (News, Sports, Hits, Kids, etc.)
- Artist name
- Song Name

If the selected channel name, artist, or title exceeds eleven characters, the display information will scroll upon selection.

Direct Tuning Mode

To enter a station directly, perform the following steps.

1. Press the **AS** button (13) once. "Direct" appears on the screen.
2. Press the **MENU** button (5) to display CH 001.
3. Turn the rotary encoder again to select the third digit of the desired channel (0-9).
4. Press **MENU** (5) to enter the number and move to the second position.
5. Turn the rotary encoder again to select the second digit of the desired channel (0 - 9).
6. Press **MENU** to enter the second number and move to the first position.
7. Turn the rotary encoder again to select the first digit of the channel you want to tune to (0 - 2).
8. Press **MENU** to enter the final number and access the channel.

NOTE: If the channel is unauthorized or invalid, "CH Unavail" appears on the LCD and the unit returns to the input interface after 2 seconds.

Category Tuning Mode

To select stations in a specific category, perform the following steps.

1. Press the **AS** button (13) twice. "CATEGORY" appears on the screen.
2. Turn the rotary encoder to move through the available categories.
3. Press the **MENU** button (5) to select the displayed category.
4. Once a category is selected, turn the rotary encoder to select stations in the current category.
5. Press **MENU** to select the displayed channel.

IPOD OPERATION

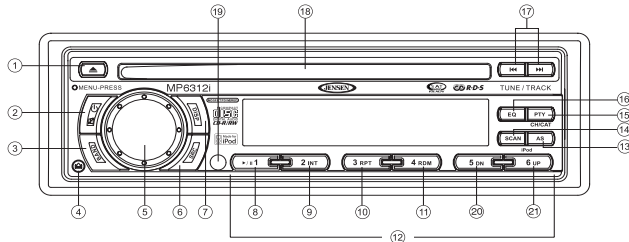

- **CMPOSER**

Press the **MENU** button (5) to select an option. At any point, you can press the **6 UP** button (21) to return to the previous option.

Some search categories require multiple selections before accessing a track, depending on the file structure on your iPod and availability of items in a particular search category. For example, after selecting **GENRE** you may be required to select **GENRE > ARTIST > ALBUM > SONG** before accessing the desired track. Continue using the rotary encoder/**MENU** button until you locate the track you would like to play.

Accessing iPod Mode

Press the **SRC** button (6) to change to iPod playback mode.

Selecting a Track

Press the **TUNE/TRACK >>|** or **|<<** button (17) to select a track.

Press and hold the **TUNE/TRACK >>|** or **|<<** button (17) to fast forward or fast reverse through the track.

Display Modes

Press the **DISP** button (7) to change the ID3 display to the following options in the order listed.

- Track number and elapsed playing time
- Song name
- Artist name
- Album name

If the selected album name, artist, or title exceeds eleven characters, the display information will scroll upon selection.

iPod Category Search

Press the **6 UP** button (21) to enter the iPod menu. Turn the rotary encoder (5) to choose from the following categories:

- PLIST
- ARTIST
- ALBUM
- GENRE
- SONG

REMOTE CONTROL

The remote control will allow you to control the basic functions of the MP6312i.

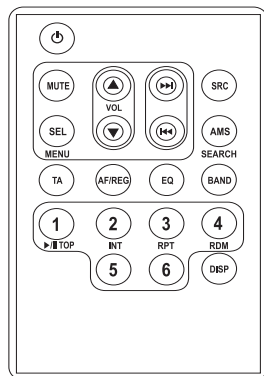

Operating Range

The remote control sensor (19) is located to the right of the **SRC** button. The remote control can operate within a distance of 3~5m.

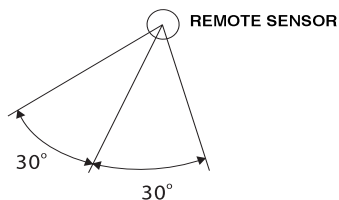

Replacing the Battery

When the range of operation of the card remote control becomes short or stops functioning, replace the battery with a new lithium battery. Be sure to observe the proper polarity, as indicated below.

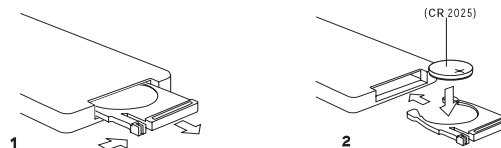

CARE AND MAINTENANCE

CD Player

The following guidelines will help you extend the life of your CD player:

1. When cleaning the vehicle interior, do not get water or cleaning fluids on the unit.
2. The CD player will not operate properly in extreme hot/cold or under damp conditions. In case of such conditions, wait until the vehicle interior reaches a normal temperature or any condensation on the disc player lens has evaporated before using the player.
3. Never insert anything other than round 5" CDs into the player. Attempting to insert CDs of other sizes (even with an adaptor) will cause damage not covered by the warranty.
4. Always remove the CD when the player is not in use.
5. The unit is designed with a vibration dampening CD mechanism to minimize interruption of disc play due to normal vibration in a moving vehicle. However, occasional sound skips may occur when driving on very rough roads. This will not scratch or damage the disc, and normal play will resume when the rough conditions cease.

Compact Discs

CD-R and CD-RW Capability

Depending on media type and method of "recording/burning", some CD-R/RWs may be incompatible with this unit. After "recording/burning", the session **must be closed**. Please refer to your software's recommended procedures for closing a disc/session. Review your recording software to familiarize yourself with the correct "recording/burning" procedures. We recommend using the latest versions of ROXIO™ or NERO™ burning software.

In addition, this unit will only recognize the CDDA (Compact Disc Digital Audio), .MP3 and .WMA formats "recorded / burned" onto a CD-R/RW. **This unit does not support .WAV, .OGG or other formats.**

CD Care and Handling

Dirt, dust, scratches and warpage can cause skips in the playback and deterioration of sound quality. Please follow these guidelines to take care of your compact discs.

1. Carefully wipe fingerprints, dust and dirt from the disc's playing surface with a soft cloth. Wipe in a straight motion from the inside to the outside of the disc.
2. Never use chemicals such as record sprays or household cleaners to clean CDs, as they can irreparably damage the disc's surface.

3. Discs should be kept in their storage cases when not in use.
4. Do not expose discs to direct sunlight, high temperatures or high humidity for long periods.
5. **Do not stick paper, tape or CD labels on disc surfaces, as internal damage may occur.**

TROUBLESHOOTING

Problem	Cause	Corrective Action
Does not operate (display does not light)	No power to yellow wire; no power to red wire	Check connection with test light; check vehicle fuse with test light
	Inline fuse blown	Replace fuse
No power to unit	Inline fuse blown	Check/replace fuse
No speakers operate (display lights normally)	Speaker harness not connected	Connect speaker harness; check speaker wires
Not all speakers operate	Incorrect splices or connections	Check all splices and connections
	Speaker wires shorting to chassis ground or to each other	Check splices; insulate all bare wires
Blows fuses	Power wire shorting to ground	Make sure wire is not pinched
	Speaker wires shorting to ground	Make sure wire is not pinched
	Incorrect fuse; fuse too small	Install fuse of correct rating

SPECIFICATIONS

CEA Power Ratings



*Specifications subject to change without notice.

Power Output 18 watts RMS X 4 channels into 4-ohms @ < 1% THD+N
 Signal to Noise Ratio 70dBA below reference (reference: 1 watt, 4-ohms)
 Frequency Response 20Hz to 20kHz (-3dB), Auxiliary input used as source reference
 Reference Supply Voltage 14.4VDC

CD Player

Compatible Disc Media CD-R / RW
 Compatible Media Formats CD-DA, MP3, WMA
 Signal to Noise Ratio @ 1 kHz >90dB
 Frequency Response 20Hz to 20 kHz, -3dB
 Channel Separation > 60dB @ 1 kHz
 D/A Converter 1bit/ channel

FM Tuner

Tuning Range 87.5MHz - 107.9MHz
 Mono Sensitivity (-30dB) 11dBf
 Quieting Sensitivity (-50dB) 15dBf
 Signal to Noise Ratio @ 1 kHz 58dB
 Stereo Separation @ 1 kHz: >30dB
 Frequency Response 30Hz - 12kHz, -3dB

AM Tuner

Tuning Range 530 kHz - 1710 kHz
 Sensitivity (-20dB) 15uV
 Signal to Noise Ratio @ 1 kHz 50dB
 Frequency Response 50Hz - 2kHz, -3dB

Auxiliary Input

Input Sensitivity 400mV RMS for 1 watt RMS into 4-ohms
 Frequency Response 20Hz to 20kHz, -3dB
 Input Impedance 10k ohms

General

Power Supply 11 to 16VDC, negative ground
 Power Antenna (Blue) 500mA max, current limited protection
 Operating Temperature -20C ~ 65C
 Fuse 15-amp, ATO type
 DIN Chassis Dimensions 7" X 7" X 2" (178mm x 178mm x 50mm)

Limited Warranty

CD or Multimedia Radios/Headunits

DO NOT RETURN THIS PRODUCT TO THE STORE

Audiovox Electronics Corporation (“the Company”) is committed to quality and customer service, and are pleased to offer you this Warranty. Please read it thoroughly and contact the Company at 1-800-323-4815 with any questions.

Who is covered?

The Company extends this warranty to the original retail purchaser of products purchased through an authorized Audiovox retailer in the U.S.A., Puerto Rico or Canada. This warranty is not transferable or assignable. Proof of purchase is required in the form of an original sales receipt.

What is covered?

The Company warrants that should this product or any part thereof, under normal use, be proven defective in material or workmanship within 12 months from the date of original purchase, such defect(s) will be repaired or replaced with a new or reconditioned product (at the Company's option) without charge for parts and repair labor.

What is not covered?

This Warranty *does not* cover the following:

- Damage incurred during shipping or transporting the product to the Company or a service center
- Elimination of car static or motor noise
- Defects in cosmetic, decorative or non-operative structural parts
- Correction of antenna problems
- Costs incurred for installation, removal or reinstallation of the product
- Consequential damage to compact discs, USB devices, digital media cards, accessories or vehicle electrical systems
- Damage caused by improper installation, mishandling, misuse, neglect, accident, blown fuse, battery leakage, theft or improper storage
- Products whose factory serial number/bar code label(s) or markings have been removed or defaced
- Damage resulting from moisture, humidity, excessive temperature, extreme environmental conditions or external natural causes

Please review the “Care and Maintenance” section of your Installation and Operation Manual for additional information regarding the proper use of your product.

Limitations

THE EXTENT OF THE COMPANY'S LIABILITY UNDER THIS WARRANTY IS LIMITED TO THE REPAIR OR REPLACEMENT PROVIDED ABOVE AND, IN NO EVENT, SHALL THE COMPANY'S LIABILITY EXCEED THE PURCHASE PRICE PAID BY PURCHASER FOR THE PRODUCT.

This Warranty is in lieu of all other express warranties or liabilities. ANY IMPLIED WARRANTIES, INCLUDING ANY IMPLIED WARRANTY OF MERCHANTABILITY, SHALL BE LIMITED TO THE DURATION OF THIS WRITTEN WARRANTY. ANY ACTION FOR BREACH OF ANY WARRANTY HEREUNDER INCLUDING ANY IMPLIED WARRANTY OF MERCHANTABILITY MUST BE BROUGHT WITHIN A PERIOD OF 24 MONTHS FROM DATE OF ORIGINAL PURCHASE. IN NO CASE SHALL THE COMPANY BE LIABLE FOR ANY CONSEQUENTIAL OR INCIDENTAL DAMAGES FOR BREACH OF THIS OR ANY OTHER WARRANTY, EXPRESS OR IMPLIED, WHATSOEVER. No person or representative is authorized to assume for the Company any liability other than expressed herein in connection with the sale of this product.

Some states do not allow limitations on how long an implied warranty lasts or the exclusion or limitation of incidental or consequential damage so the above limitations or exclusions may not apply to you. This Warranty gives you specific legal rights and you may also have other rights which vary from state to state.

Obtaining Warranty Service

- To obtain repair or replacement within the terms of this Warranty, call 1-800-323-4815 for the location of a warranty station serving your area.
- You must prepay the initial shipping charges to the Company. The Company will pay the return shipping charges for all warranted products returned to an address within the U.S.A., Puerto Rico or Canada.
- Please package the product securely to avoid shipping damage. We recommend using a carrier that provides tracking service to prevent lost packages. Lost or damaged packages are not covered by this warranty.
- Provide a detailed description of the problem(s) for which you require service.



Audiovox Electronics Corporation
Hauppauge, NY 11788
Technical Assistance: 1-800-323-4815
www.jensen.com

© 2007 Audiovox
Ver. 021607
Printed in China

Free Manuals Download Website

<http://myh66.com>

<http://usermanuals.us>

<http://www.somanuals.com>

<http://www.4manuals.cc>

<http://www.manual-lib.com>

<http://www.404manual.com>

<http://www.luxmanual.com>

<http://aubethermostatmanual.com>

Golf course search by state

<http://golfingnear.com>

Email search by domain

<http://emailbydomain.com>

Auto manuals search

<http://auto.somanuals.com>

TV manuals search

<http://tv.somanuals.com>