



VM9312

Instruction Manual



CONTENTS

Thank you for choosing a Jensen product. We hope you will find the instructions in this owner's manual clear and easy to follow. If you take a few minutes to look through it, you'll learn how to use all the features of your new Jensen VM9312 Mobile Multimedia Receiver for maximum enjoyment.

Preparation.....	1
Installation	2
Controls and Indicators	5
Controls and Indicators	6
Remote Control	7
Using the TFT Monitor	10
Operating Instructions	12
Setup Menu	13
Tuner Operation	15
Satellite Radio Operation	17
DVD/VCD Video Operation	19
DVD/CD Audio Operation	22
MP3/WMA Operation	23
iPod Operation	25
Troubleshooting	26
Specifications	29

PREPARATION

Congratulations on your purchase of the Jensen VM9312 Mobile Multimedia Receiver.

It's a good idea to read all of the instructions before beginning the installation. We recommend having your Jensen VM9312 installed by a reputable installation shop.

Features

DVD

- Aspect Ratio - Full and Normal
- Fast Forward - 2X, 4X, 8X and 32X
- Slow Motion - 1/2, 1/4, 1/6 and 1/7
- Play, Pause, Stop, Next Chapter and Previous Chapter

CD / MP3 / WMA

- CD-Text Compatible
- ID3 Tag Compatible
- Directory Search (MP3 / WMA Only)
- Direct Track Access via Remote Control
- Burn up to 1500 MP3 and WMA Files onto a DVD+R / RW
- Audible Forward / Reverse Track Search (CD-DA Only)
- Random, Repeat and Intro
- Play, Pause, Stop, Next Track and Previous Track

AM-FM

- USA / Europe / Latin America / Asia Frequency Spacing
- 30 Station Presets (18 FM / 12 AM)
- Auto Stereo / Mono
- Local / Distance
- Auto Store / Preview Scan
- RDS - Radio Data System

Sat Radio Ready

- Compatible with XM and Sirius Tuners (Sold Separately)
- Requires XMDJEN100 and JXMC Cables (Sold Separately)
- Satellite Channel Name, Artist, Song and Categories Displayed
- On TFT Screen

jLinkDirect

- High Speed Direct Connect Interface to Access iPod Playlists, Artists, Albums, Songs, **Photos and **Video (** Requires Photo or Video iPod)
- Intuitive Interface for easy iPod Navigation
- Power Management charges iPod while connected
- Requires jLinkCable (Sold Separately)

MediaLink

- Under dash Interface allows Portable Media Devices to be connected
- MediaLink1 includes the following connectivity:

- jLinkDirect 8-pin DIN for iPod
- 3.5mm audio only Input
- RCA Audio / Video Input

Chassis

- 1.0 DIN (Import / ISO-DIN Mountable)
- Motorized Flip-Out / Flip-Up LCD Screen
- 8 Character / Segment Type Secondary LCD Display
- 7" TFT Active Matrix LCD w/ Anti-Glare Coating
- 336,960 Sub Pixels (1440W X 234H)
- Pixel Pitch - 0.321W X 0.370H
- Screen Tilt / Angle Adjustment
- Beep Tone Confirmation (On-OFF Option)
- Heat Management System - Forced Air Cooling to keep the chip sets operating at nominal temperatures

General

- 44-Key Infrared Remote Control
- Two Composite Video Outputs for Additional Screens
- Two Audio / Video Auxiliary Inputs for Game Console, Camcorder, Navigation, etc.
- Three-Band Tone control (Bass, Mid and Treble) w/ Eight Preset EQ Curves
- Front, Rear and Subwoofer Line Output
- Subwoofer Phase Control - 0 ~ 180 degrees
- Programmable Volume Control
- Rear Camera Input (Normal and Mirror Image View)
- Touch Screen Calibration Mode
- 100-Ohm Preamp Line Output - All Audio Channels
- 2VRMS Line Output - All Channels
- Rotary Encoder Audio Control
- 5-Way Joystick

Tools and Supplies

You will need these tools and supplies to install your VM9312:

- Torx type, flat-head and Philips screwdrivers
- Wire cutters and strippers
- Tools to remove existing radio (screwdriver, socket wrench set or other tools)
- Electrical tape
- Crimping tool
- Volt meter/test light
- Crimp connections
- 18 gauge wire for power connections
- 16 – 18 gauge speaker wire

WARNING! Only connect the unit to a 12-volt power supply with proper grounding.

WARNING! Never install this unit where operation and viewing could interfere with safe driving conditions.

WARNING! To reduce the risk of a traffic accident (except when using for rear view video camera) never use the video display function while driving the vehicle. This is a violation of federal law.

WARNING! Never disassemble or adjust the unit.

WARNING! To prevent injury from shock or fire, never expose this unit to moisture or water.

WARNING! Never use irregular discs.

WARNING! To prevent damage to the mechanism inside this unit, avoid impact to the TFT monitor.

WARNING! Using an improper fuse may cause damage to the unit and result in a fire.

WARNING! The monitor employs an automatic motorized mechanism. To prevent damage to the core mechanism, please do not push, pull or swivel the monitor manually.

Optional Accessories

- jLinkCable - iPod interface Cable

Disconnecting the Battery

To prevent a short circuit, be sure to turn off the ignition and remove the negative (-) battery cable prior to installation.

NOTE: If the VM9312 is to be installed in a car equipped with an on-board drive or navigation computer, do not disconnect the battery cable. If the cable is disconnected, the computer memory may be lost. Under these conditions, use extra caution during installation to avoid causing a short circuit.

INSTALLATION

Pre-installation

1. Press the metal levers on both sides to remove the half-sleeve from the radio.

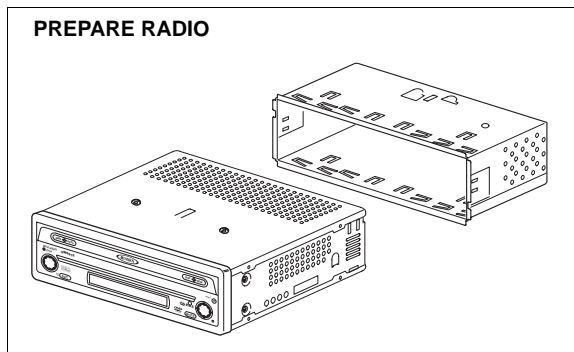

2. Install the half-sleeve.
 - a. Install adapter if necessary (optional).
 - b. Install half-sleeve into adapter or dashboard (use only the supplied screws). Do not force the sleeve into the opening or cause it to bend or bow.
 - c. Locate the series of bend-tabs along the top, bottom and sides of the mounting sleeve. With the sleeve fully inserted into the dashboard opening, bend as many of the tabs outward as necessary so that the sleeve is firmly secured to the dashboard.
 - d. Install support strap to make the unit more stable.

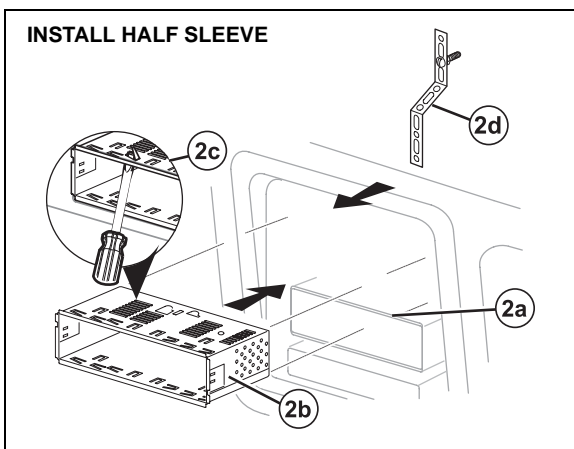

CAUTION! Be careful not to damage the car wiring.

3. Place the radio in front of the dashboard opening so the wiring can be brought through the mounting sleeve.

Wiring

Complete wiring as illustrated in the wiring diagram on page 3. Once the wiring is complete, reconnect the battery negative terminal. If there is no ACC available, connect the ACC lead to the power supply with a switch.

NOTE: When replacing a fuse, be sure to use correct type and amperage to avoid damaging the radio. The VM9312 uses one 10 amp mini-ATM fuse, located in the black filter box in-line with the main wire harness.

Final Installation

After completing the wiring connections, turn the unit on to confirm operation (ignition switch must be on). If unit does not operate, recheck all wiring until problem is corrected. Once proper operation is achieved, turn off the ignition switch and proceed with final mounting of the chassis.

1. Connect wiring adapter to existing wiring harness.
2. Connect antenna lead.
3. Carefully slide the radio into the half-sleeve, making sure it is right-side-up, until it is fully seated and the spring clips lock it into place.

NOTE: For proper operation of the CD/DVD player, the chassis must be mounted within 20° of horizontal. Make sure the unit is mounted within this limitation.

4. Attach one end of the perforated support strap (supplied) to the screw stud on the rear of the chassis using the hex nut provided. Fasten the other end of the perforated strap to a secure part of the dashboard either above or below the radio using the screw and hex nut provided. Bend the strap to position it as necessary.

CAUTION! The rear of the radio must be supported with the strap to prevent damage to the dashboard from the weight of the radio or improper operation due to vibration.

5. Replace any items you removed from the dashboard.

FINAL INSTALLATION

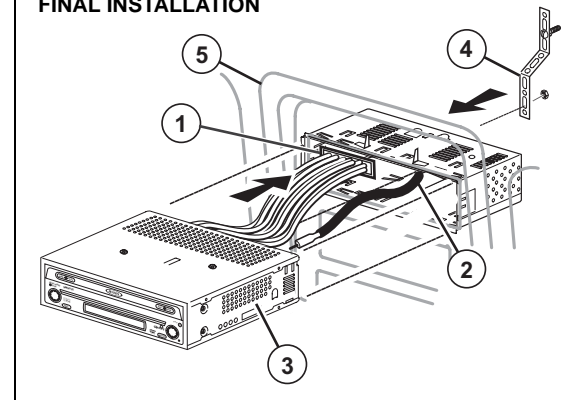

Final ISO-DIN Installation

1. Remove trim ring.
2. Mount factory brackets on new radio using existing screws from old radio.
3. Slide radio chassis into dash opening and secure.
4. Reinstall dash panel.

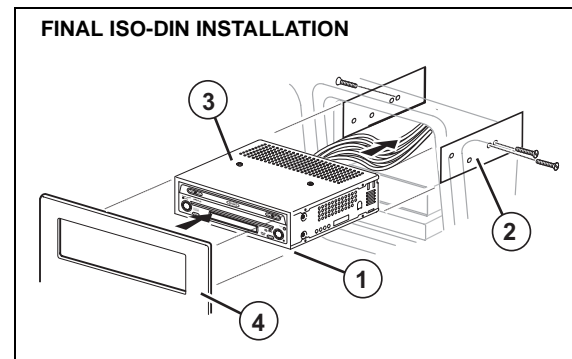

WIRING DIAGRAM

*** See the MediaLink and Satellite Connections diagram for more information about connecting a satellite receiver and an iPod (through the MediaLink).**

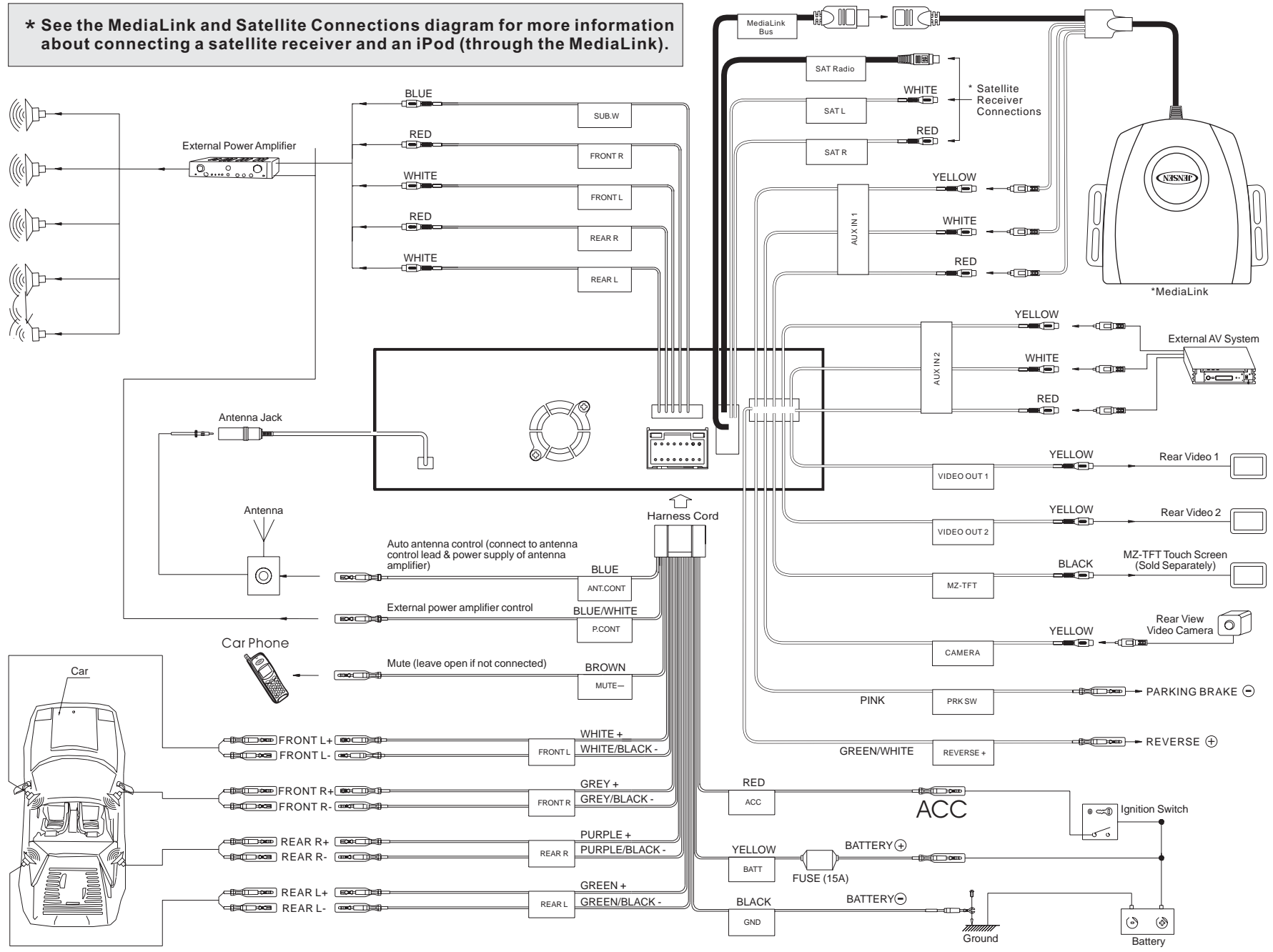

MEDIALINK AND SATELLITE CONNECTIONS

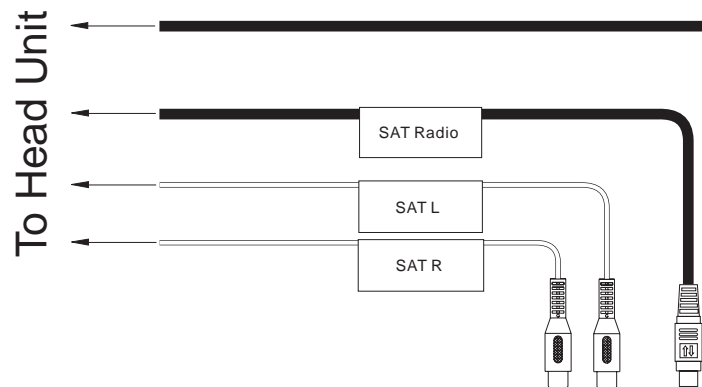

*SAT Cable Kit: JXMC or XMDJEN100 (sold separately)

**XM or Sirius satellite tuner (sold separately)

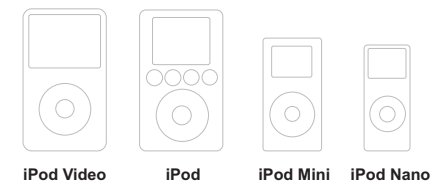
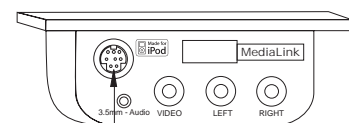
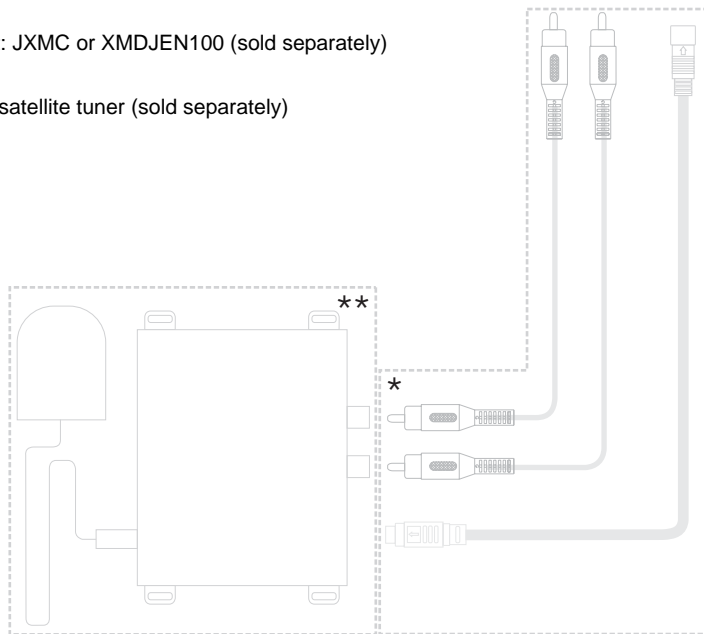

jLink iPod Cable (Sold Separately)

CONTROLS AND INDICATORS

Button Operation

1. OPEN

Press to activate the automatic mechanical system and move the TFT monitor into viewing position. Press again to close the TFT.

2. WIDE/DISP

Press to adjust the display aspect of the picture to one of two settings: Full or Normal.

With the monitor closed, press the **DISP** button to cycle through information available on the LCD screen.

3. PICTURE/AS/PS

Press to adjust the Brightness and Contrast. Press the **AUDIO** button (5) to move between Brightness to Contrast. Turn the rotary encoder (5) to adjust the setting for the selected option.

With the monitor closed, press **AS/PS** to automatically store strong radio stations in the six preset channels in the current band.

4. TILT/BAND

Press to activate the tilt function. Use the joystick to make adjustments while the red tilt icon is flashing. Press once to adjust the downward tilt angle of the screen one step at a time or *press and hold* to adjust the angle in a continuous motion.

With the monitor closed, press the **BAND** button to change the AM, FM or SAT band.

5. AUDIO/LO/DX

Rotate to adjust the volume. *Press and release* to enter and/or confirm audio settings. *Press and hold* to activate the Local (LOC) setting.

6. SRC

Press once to select playing mode.

7. LCD Display

8. MUTE

Press to silence the receiver. Press again to resume previous volume level.

NOTE: The VM9312 features *Softmute*, which will allow the volume to increase or decrease gradually when the *MUTE* function is activated or deactivated.

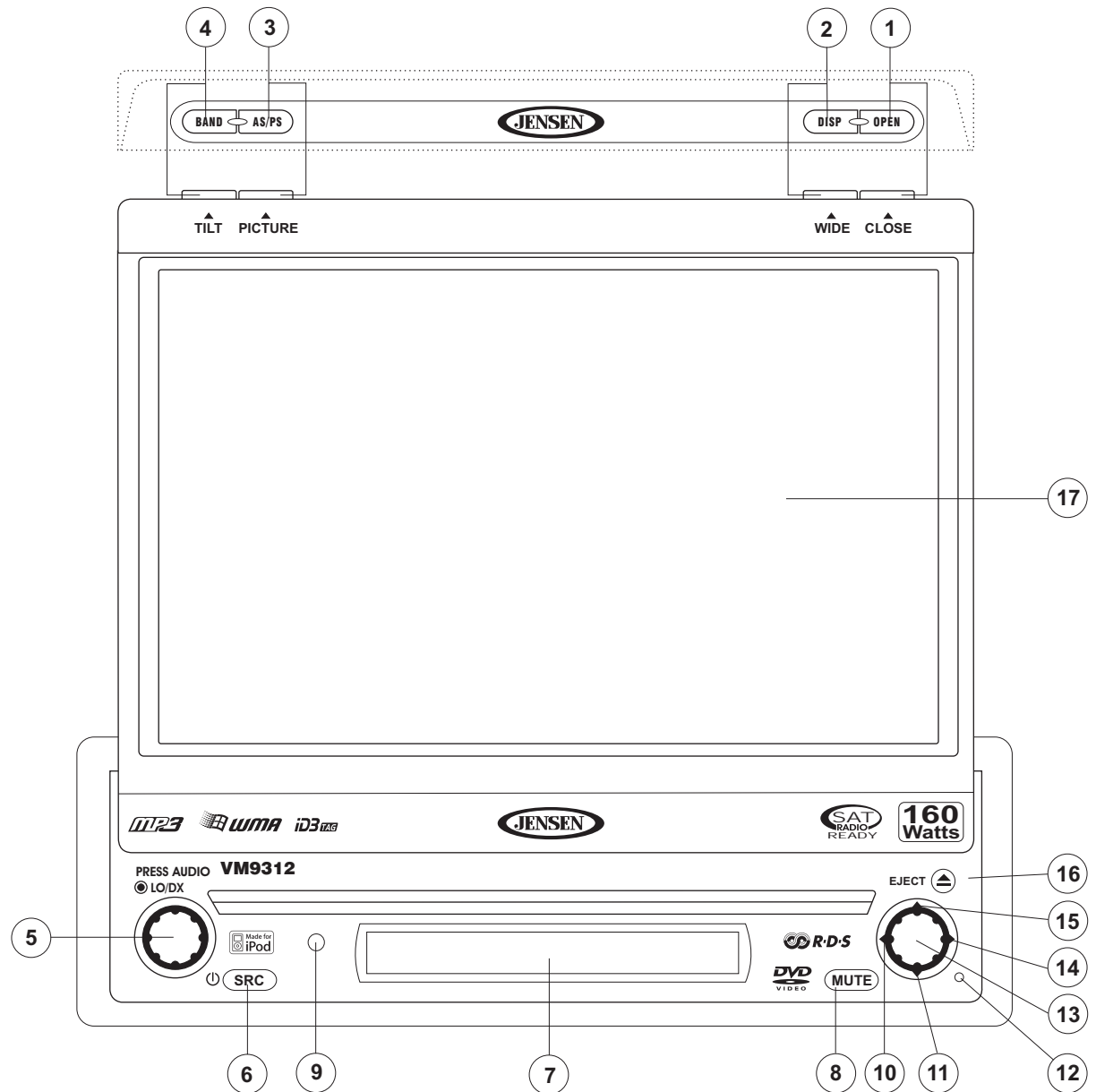

CONTROLS AND INDICATORS

9. IR Remote Control Receiver

10. (◀)

DVD Mode: Press once to play back the previous chapter/track.

TUNER Mode: Press once to auto-search for the previous available radio station.

MENU Mode: Press once to move the cursor to the left.

11. (▼)

DVD Mode: Press once for slow forward/slow reverse.

TUNER Mode: Press to go down one frequency step.

MENU Mode: Press once to move the cursor down.

12. RESET

Press to reset system settings to factory default (except the password and parental lock setting).

13. Pause/Play/Enter

Press to pause or resume playback or to confirm current selection.

14. (▶)

DVD Mode: Press once to enter the next chapter or track.

TUNER Mode: Press once to auto-search the next available radio station.

MENU Mode: Press once to move the cursor to the right.

15. (▲)

DVD Mode: Press once for fast forward/fast reverse.

TUNER Mode: Press to go up one frequency step.

MENU Mode: Press once to move the cursor up.

16. (▲)

Press once for disc insertion/ejection.

Press and hold to reset core mechanism position.

17. TFT Display

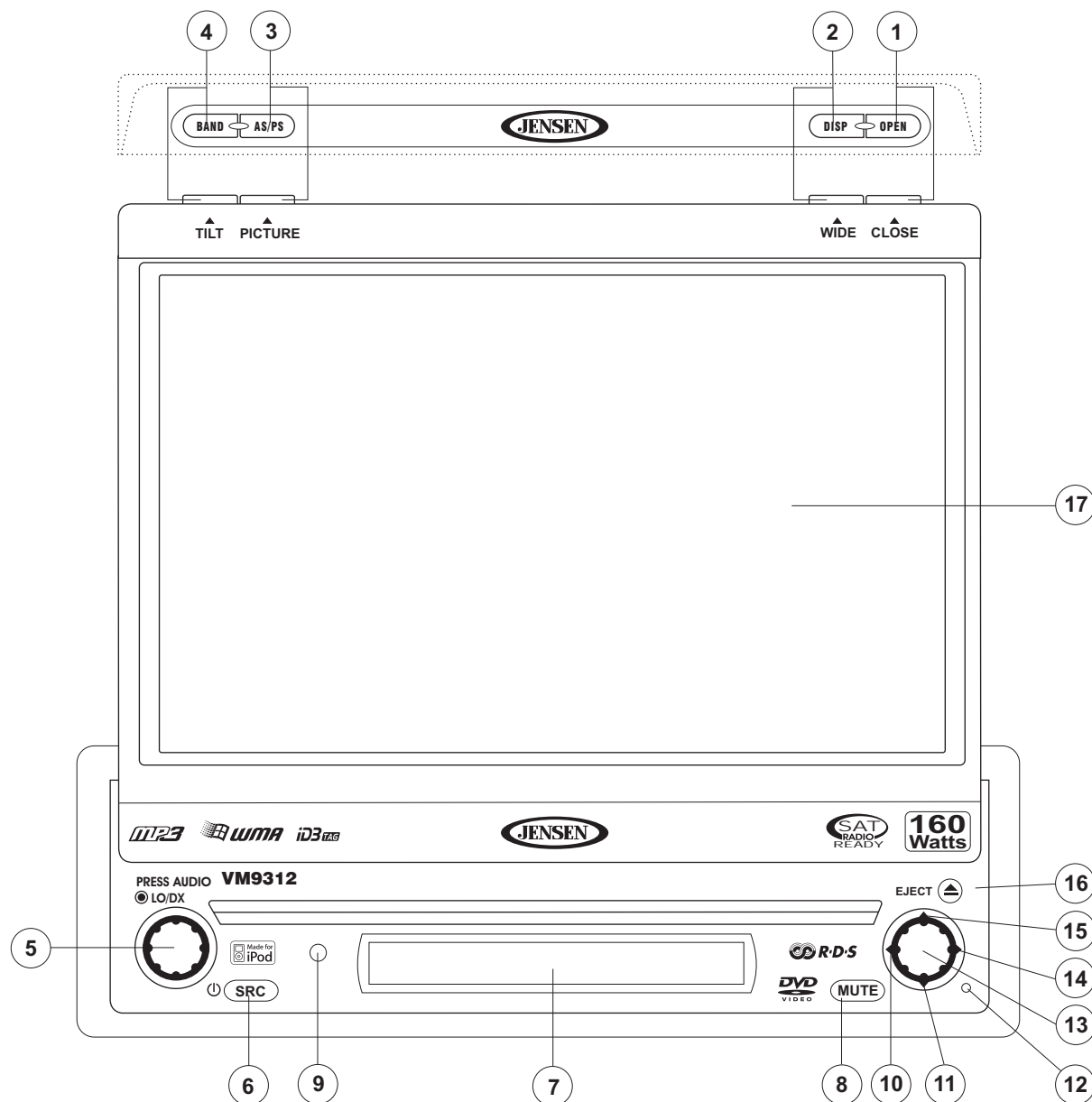

REMOTE CONTROL

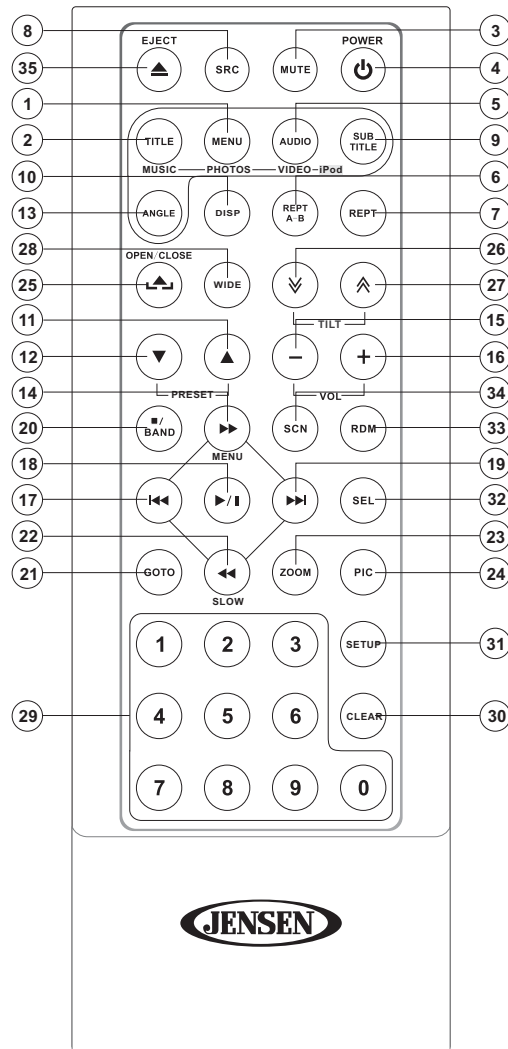

NOTE: Your remote control may differ slightly from the one pictured here. The above diagram is for illustrative purposes only.

Table 1: Remote Control Functions

Button		Function					
Name	Ref#	DVD	VCD	TUNER	CD/MP3	SATELLITE	iPod
MENU	1	Enters the main menu of the disc	Turns on/off PBC when playing VCD			Displays diagnostics screen	Selects Photo mode
TITLE	2	Enters the title menu of the disc	Plays first ten seconds of each chapter/title				Selects Music mode
MUTE	3	Toggles on/off audio output	Toggles on/off audio output	Toggles on/off audio output	Toggles on/off audio output	Toggles on/off audio output	Toggles on/off audio output
POWER/⏻	4	Turns the power on/off	Turns the power on/off	Turns the power on/off	Turns the power on/off	Turns the power on/off	Turns the power on/off
AUDIO	5	Changes the audio language for disc playback					Selects Video mode
REPT A-B	6	Setup to repeat playback from time frame A to time frame B	Setup to repeat playback from time frame A to time frame B				
REPT	7	Repeats playback of current chapter	Repeats playback of current chapter		Repeats playback of current track		Repeats playback of current track
SRC	8	Selects playing mode	Selects playing mode	Selects playing mode	Selects playing mode	Selects playing mode	Selects playing mode
SUBTITLE	9	Language selection for subtitle					
DISP	10	Displays playing information	Displays playing information	Displays playing information	Display playing information		Displays playing information
PRESET ▲	11			Navigates the preset station list			
PRESET ▼	12			Navigates the preset station list			
ANGLE	13	Plays back disc in different angle for a scene	Plays back Picture CD with different angle of picture displayed				
▶▶	14	Fast forwards the disc content	Fast forwards the disc content		Fast forwards the disc content		Accesses iPod Menu
VOL -	15	Decreases volume	Decreases volume	Decreases volume	Decreases volume	Decreases volume	Decreases volume
VOL +	16	Increases volume	Increases volume	Increases volume	Increases volume	Increases volume	Increases volume
◀◀	17	Selects the previous chapter for playback	Selects the previous chapter for playback	Searches an available radio station by decreasing tuning frequency	Selects the previous track for playback	Searches an available radio station by decreasing tuning frequency	Pauses playback/starts playback
▶/II	18	Pauses playback/starts playback	Pauses playback/starts playback		Pauses playback/starts playback	Toggles the on-screen menu between CAT/CH mode	
▶▶	19	Selects the next chapter for playback	Selects the next chapter for playback	Searches an available radio station by increasing tuning frequency	Selects the next track for playback	Searches an available radio station by increasing tuning frequency	Selects the next track for playback
■/BAND	20	Stops playback	Stops playback	Selects FM/AM band	Stops playback	Selects SAT1, SAT2, or SAT3 band	
GOTO	21	Goes to specific time frame and playback	Goes to specific time frame and playback				
◀◀	22	Slow playback/slow rewind playback	Slow playback/slow rewind playback				
ZOOM	23	Zooms in/out on an image	Zooms in/out on an image				
PIC	24	Displays set-up parameters	Displays set-up parameters				

Table 1: Remote Control Functions

Button		Function					
Name	Ref#	DVD	VCD	TUNER	CD/MP3	SATELLITE	iPod
OPEN/ CLOSE	25	Opens/closes the TFT monitor	Opens/closes the TFT monitor	Opens/closes the TFT monitor	Opens/closes the TFT monitor	Opens/closes the TFT monitor	Opens/Closes the TFT monitor
∨	26	Decreases monitor tilt angle	Decreases monitor tilt angle	Decreases monitor tilt angle	Decreases monitor tilt angle	Decreases monitor tilt angle	Decreases monitor tilt angle
∧	27	Increases monitor tilt angle	Increases monitor tilt angle	Increases monitor tilt angle	Increases monitor tilt angle	Increases monitor tilt angle	Increases monitor tilt angle
DISP	28	Selects display mode: FULL or NORMAL	Selects display mode: FULL or NORMAL				
1, 2, 3, 4, 5, 6, 7, 8, 9, 0 (Numeric Keypad)	29	Directly accesses chapter		1-6 selects preset for current band	Directly accesses track	1-6 selects preset for current band	
CLEAR	30	Delete entry or move backwards to correct error in Direct Access mode	Delete entry or move backwards to correct error in Direct Access mode	Delete entry or move backwards to correct error in Direct Access mode	Delete entry or move backwards to correct error in Direct Access mode	Delete entry or move backwards to correct error in Direct Access mode	Delete entry or move backwards to correct error in Direct Access mode
SETUP	31	Displays Setup menu	Displays Setup menu	Displays Setup menu	Displays Setup menu	Displays Setup menu	Displays Setup menu
SEL	32						
RDM	33	Plays all chapters in random order			Plays all tracks in random order		Plays all tracks in random order
SCN	34				Plays the first ten seconds of each track		
EJECT	35	Ejects disc	Ejects disc	Ejects disc	Ejects disc	Ejects disc	Ejects disc

USING THE TFT MONITOR

Open/Close TFT Monitor

Open TFT Monitor

Press the **OPEN** button (1) on the front panel or press the (▲) button (25) on the remote control to activate the mechanism that moves the display panel into the viewing position.

Close TFT Monitor

Press the **OPEN** button (1) on the front panel or press the (▲) button (25) on the remote control to load the display panel back into the compartment.

TFT Monitor Auto Open

If "TFT Auto Open" is "on" when the unit is turned on, the monitor automatically moves to the viewing position.

If "TFT Auto Open" is "off" when the unit is turned on, press the **OPEN** button (1) or (▲) button (25) on the remote control to move the monitor into the viewing position.

If "TFT Auto Open" is set to "Manual", the TFT will not close when the key is turned off.

Monitor Tilt Angle Adjustment

A known characteristic of LCD panels is the quality of the display in relationship to the viewing angle. The monitor angle can be adjusted for optimum viewing using one of the following methods:

Step by Step Angle Adjustment

Press the (▲) or (▼) button on the remote control to adjust the tilt angle of the screen one step at a time.

Continuous Angle Adjustment

Press and hold the (▲) or (▼) button on the remote control to adjust the tilt angle in a continuous motion.

Aspect Ratio

Press the **DISP** button (28) on the remote control or **DISP/WIDE** button (2) on the monitor to adjust the aspect ratio as follows:

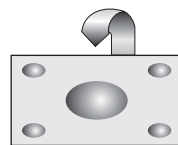

FULL

The entire screen is extended horizontally to the aspect ratio of 16 to 9. The extension ratio is the same at any point.

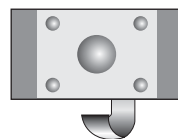

NORMAL

The conventional display image has a 4 to 3 ratio of horizontal to vertical, leaving a blank area on the right and left sides of the display.

Image Setting

Table 2 shows the video output mode for each playing source.

Table 2: Video Output Modes

Playing Source	Video Output Modes
AM/FM TUNER	RGB Mode
SAT TUNER	RGB Mode
iPod	RGB Mode
DVD	RGB Mode
AUX IN	CVBS Mode

*CVBS – Composite Video Baseband Signal

Parameter Adjustment Procedure

- Enter Picture Quality Setting Mode:**
Press the **PIC** button (24) on the remote control or the **PICTURE/AS/PS** button (3) on the monitor.
- Select Item to Set:**
Press the **AUDIO** button (5) on the control panel to select "BRIGHT" or "CONTRAST".
- Set Parameters:**
Press the +/- buttons (15, 16) on the remote or turn the rotary encoder (5) on the control panel.
- Exit Picture Quality Setting Mode:**
Press the **PIC** button (24) on the remote control or the **PICTURE/AS/PS** button (3) on the monitor

Parking Brake

Parking Brake Inhibit

When the pink "Parking" wire is connected to the vehicle brake switch, the front TFT monitor will display video only when the parking brake sequence is engaged. Before starting the parking brake sequence, the radio must be on with the video media disc inserted and playing.

Parking Brake Sequence

There are two situations that can start the Parking Brake Sequence (this is the preferred method). The timing window is between 3 ~ 5 seconds.

- Parking brake is engaged (on) when the vehicle is started or the accessory/ignition is turned on. To activate video, the following sequence of events must be completed:**
 - Release parking brake for 3 ~ 5 seconds.
 - Reapply parking brake.
 - Video should be displayed on the TFT monitor within 1 ~ 2 seconds.
- Parking brake is disengaged (off) when the vehicle is started or the accessory/ignition is turned on. To activate video, the following sequence of events must be completed:**
 - Set parking brake for 3 ~ 5 seconds.
 - Release parking brake for 3 ~ 5 seconds.
 - Reapply parking brake.
 - Video should be displayed on the TFT monitor within 1 ~ 2 seconds.

Monitor Movement Mechanism

If an obstruction occurs in the monitor path, the following protective measurements can be executed to prevent damage to the mechanism or monitor:

Table 3: Monitor Protective Measures

Obstruction	Self Protection	OPEN Button Pressed	Power Reconnected
Monitor loading out horizontally	Monitor is automatically loaded into unit	Monitor fully extended horizontally	Monitor is automatically loaded into unit
Monitor loading in horizontally	Unit stops at obstruction point	Monitor fully extended horizontally	Monitor is automatically loaded into unit

Table 3: Monitor Protective Measures

Obstruction	Self Protection	OPEN Button Pressed	Power Reconnected
Monitor loading out vertically	Unit stops at obstruction point	Monitor swivels back to the unit	Monitor swivels back to the unit
Monitor loading in vertically	Unit stops at obstruction point	Monitor swivels back to the unit	Monitor swivels back to the unit

After the protective procedure is executed, normal operation is resumed by pressing the **OPEN** button (1) or disconnecting and reconnecting the power.

OPERATING INSTRUCTIONS

Power On / Off

Press the **⏻**/SRC button (6) on the unit (or the **⏻** button (4) on the remote control) to turn the unit on. The buttons on the front of the unit light up and the current mode status appears in the LCD (7). You can also turn on the unit by pressing the **OPEN** button (1) and opening the TFT screen.

Press and hold the **⏻** button to power off the unit. The monitor is drawn back into the main compartment.

Audible Beep Confirmation

An audible beep tone confirms each function selection. The Beep tone can be disabled through the Setup menu.

Mute

Press the **MUTE** button (8) on the front panel or the **MUTE** button (3) on the remote to mute the volume from the unit. Press the **MUTE** button again to restore the volume. "MUTE" is displayed on the LCD. Adjusting the volume or using any of the audio setup features cancels the mute function.

Playing Source Selection

Press the **SRC** button (6) on the front panel or the **SRC** button (8) on the remote to change between available playing sources in the following order: AM/FM, DISC, AUX IN1, AUX IN2, SAT, and CAMERA. The playing mode is displayed on the TFT and LCD screens.

External peripheral devices can be connected to this unit via RCA output or MediaLink. Select "AUX-IN1" or "AUX IN2" mode to access and control connected auxiliary devices.

Volume Adjustment

To increase or decrease the volume level, turn the rotary encoder (5) on the front panel or press the **VOL+**/ **VOL-** buttons (15, 16) on remote control. When the volume level reaches "0" or "40", a beep sounds, indicating that the adjustment limit has been reached. The volume ranges from "0" to "40". The LCD or TFT screen displays the volume level for 3 seconds.

Audio Control Menu

The Audio Control feature allows you to easily adjust your audio system to meet the acoustical characteristics of your vehicle, which vary depending on the type of vehicle and its measurements. Proper setting of the Fader and Balance boosts the effects of the cabin equalizer.

Press the **AUDIO** button (5) on the front panel once to display the audio menu. To adjust an audio feature:

1. Turn the rotary encoder (5) on the front panel, press the (>>|)/(|<<) buttons (14, 22) on the remote control, or use the joystick to highlight the audio feature to be adjusted.
2. Press the joystick button (13) to select the highlighted option.
3. Rotate the **AUDIO** button (5), press the |<<, >>|, >>, or << buttons (17, 19, 14, 22) on the remote control, or use the joystick to adjust the selected feature to the desired setting.

Table 4: Audio Adjustments

Audio Function	Adjustable Range
EQ	User
	Acoustic
	Urban
	Rave
	Latin
	Dance
	Hip Hop
	Rock
BASS	-14 to +14
MID	-14 to +14
TREBLE	-14 to +14
SUB	-14 to 0
FAD	Grid
BAL	Grid

NOTE: The EQ mode will automatically change to "USER" when individual audio functions are adjusted.

The Audio menu will automatically exit after a few seconds of inactivity. To exit quickly, touch the top left corner of the screen or press and hold the **AUDIO** button (5).

System Reset

To correct a system halt or other illegal operation, use the tip of a pen  [RESET] Button to press the reset button (12) located on the front bottom-right corner of the unit. After a system reset, the unit restores all factory default settings.

NOTE: If the unit is reset while a DVD is playing, the DVD resumes play once the reset is complete.

Line Mute

If the "MUTE" wire is connected, audio output mutes when a telephone call is received by the car phone or when verbal navigation is performed.

SETUP MENU

To access system settings, press the **SETUP** button (31) on the remote control or touch the button on the screen to enter the "SETUP" menu. The "GENERAL" sub-menu appears highlighted in blue.

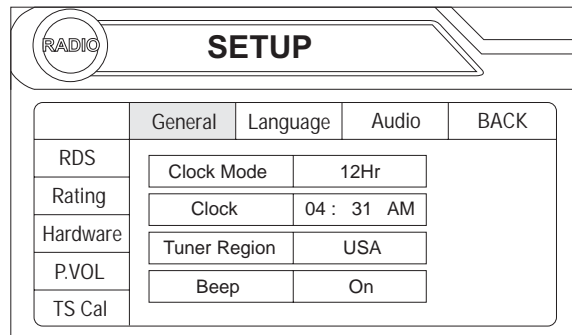

Accessing Menu Items

Touch the sub-menu name, press the <<, >>, <<<, or >>> direction buttons (22,14, 17, 19) on the remote control, or use the joystick to select a sub-menu (Language, Audio, RDS, etc.).

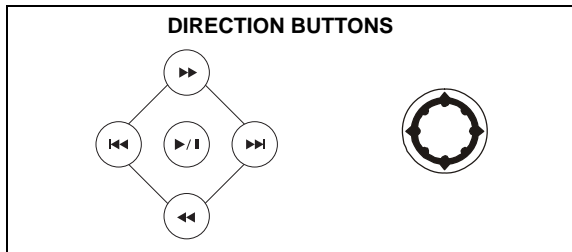

The features available for adjustment under the highlighted sub-menu option will appear in the center of the screen.

Adjusting a Feature

1. Use the touchscreen or press the **Λ** or **V** buttons (18, 19) on the joystick to select the feature to be adjusted.
2. Enter the option field for the feature you want to adjust by using the touchscreen or pressing the **>||** button (18) on the remote or the **ENTER** (joystick) button (13) on the unit. A submenu appears in a second row with the selected option highlighted in blue.

3. Select a new value by using the touchscreen or pressing the **>>** or **<<** buttons (14, 22) on the remote control or the **Λ** or **V** buttons (18, 19) on the joystick.
4. Use the touchscreen or press the **>||** button (18) on the remote control or press the joystick button (13) to confirm setup.

General Sub-menu Features

Setting	Options	Function
Clock Mode	12Hr	Clock displays 12 hour time using AM and PM.
	24Hr	Clock displays 24 hour time up to 23:59.
Clock	(HH:MM)	Clock appears in the top right corner of the screen and on the LCD screen during certain operations. NOTE: The AM/PM indication will change as you continue to adjust the hour past 12.
Tuner Region	USA	<ul style="list-style-type: none"> • AM Frequency Spacing - 10kHz • AM Frequency Band - 530kHz~1720kHz • FM Frequency Spacing - 200kHz • FM Frequency Band - 87.5MHz~107.9MHz
	S.Amer1	<ul style="list-style-type: none"> • AM Frequency Spacing - 10kHz • AM Frequency Band - 530kHz~1720kHz • FM Frequency Spacing - 100kHz • FM Frequency Band - 87.5MHz~108.0MHz
	Arabia	<ul style="list-style-type: none"> • AM Frequency Spacing - 9kHz • AM Frequency Band - 531kHz~1620kHz • FM Frequency Spacing - 100kHz • FM Frequency Band - 87.5MHz~108.0MHz
	China	<ul style="list-style-type: none"> • AM Frequency Spacing - 9kHz • AM Frequency Band - 522kHz~1620kHz • FM Frequency Spacing - 100kHz • FM Frequency Band - 87.5MHz~108.0MHz
	S. Amer2	<ul style="list-style-type: none"> • AM Frequency Spacing - 5kHz • AM Frequency Band - 520kHz~1600kHz • FM Frequency Spacing - 100kHz • FM Frequency Band - 87.5MHz~108.0MHz
	Europe	<ul style="list-style-type: none"> • AM Frequency Spacing - 9kHz • AM Frequency Band - 522kHz~1620kHz • FM Frequency Spacing - 50kHz • FM Frequency Band - 87.5MHz~108.0MHz

Setting	Options	Function
	Korea	<ul style="list-style-type: none"> • AM Frequency Spacing - 9kHz • AM Frequency Band - 531kHz~1602kHz • FM Frequency Spacing - 200kHz • FM Frequency Band - 88.1MHz~107.9MHz
Beep	On	When turned on, an audible beep tone confirms each function selection.
	Off	No beep sounds.

Language Sub-menu Features

If a DVD supports more than 1 Subtitle or Audio language, all the languages are available for selection during playback. If the selected language is not supported by the DVD, then the default language is used.

Setting	Options	Function
OSD	English	On Screen Display appears in English.
DVD Audio	English	DVD Audio is heard in English when the option is available.
DVD Subtitle	English	DVD subtitles automatically appear in English when available.
	Auto	DVD subtitles appear according to the default subtitle language specified on the disc.
	Off	DVD subtitles do not appear automatically.
Disc Menu	English	DVD menu (if applicable) is displayed in English.

Audio Sub-menu Features

Setting	Options	Function
DRC	Off	Employ the Dynamic Range Control for better playback for low volumes.
	On	
Subwoofer	Off	Turn the subwoofer on/off.
	On	

Setting	Options	Function
Sub.W Phase	0	Subwoofer output IN phase
	180	Subwoofer output OUT OF phase
		<i>NOTE: Depending on your installation, reversing the subwoofer phase may increase Bass output.</i>
Sub Filter	80Hz	Selecting a crossover frequency sets a cut-off frequency of the subwoofer's LPF (low-pass filter) and the "SMALL" speakers' HPF (high-pass filter). The Crossover frequency setting has no effect if the subwoofer is set to "OFF" and any other speaker is set to "LARGE".
	100Hz	
	120Hz	

RDS Sub-menu Features

Setting	Options	Function
RDS	On	Unit will display Radio Data System information when available.
	Off	

Rating Sub-menu Features

The DVD system has a built-in parental lock feature to prevent unauthorized persons from viewing restricted disc content. By default, the rating system is unlocked. Once setup, the parental lock is released only by entering the correct password. Once the password is entered, rating is available for setup.

Setting	Options	Function
Password	----	Enter a 4-digit password to activate the "Rating" feature.
Rating	1. Kid Safe	Select the appropriate rating level for the intended audience. You may override higher ratings by using your password.
	2. G	
	3. PG	
	4. PG-13	
	5. PG-R	
	6. R	
	7. NC-17	
	8. Adult	

Setting	Options	Function
Load Factory	Reset	Select "Reset" to restore the factory default settings for the Rating system only.

To reset the password, access the "RATING" menu and enter the current password. Once the correct password is entered, you can access the "Password" field and enter a new one.

NOTE: Record the password and keep it in a safe place for future reference. The rating for each disc is marked on the disc, disc packing, or documentation. If the rating is not available on the disc, the parental lock feature is unavailable. Some discs restrict only portions of the disc and the appropriate content will play. For details, please refer to the disc description.

Hardware Sub-menu Features

If the rear-view video camera is connected, the unit is on, and the TFT monitor is retracted inside the unit, the TFT monitor automatically moves into the viewing position and Camera mode is selected upon shifting into REVERSE gear. When shifting into DRIVE gear, the TFT monitor is retracted back inside unit.

Setting	Options	Function
Camera In	Normal	
	Mirror	
TFT Auto Open	On	The TFT panel automatically opens when the unit is turned on.
	Off	You must press the OPEN button (1) to open the TFT panel.
	Manual	When the ignition is turned OFF, the TFT panel DOES NOT retract if it was previously out
Video Input (Input circuitry auto-detects the video signal from the Aux In source).	NTSC	The color signals are output in the standard NTSC format.
	PAL	The color signals are output in the standard PAL format.
	Auto	The color signal output is switched automatically based on the current video input signal - NTSC or PAL.

If the monitor is in display mode, the monitor automatically switches to CAMERA mode upon reverse driving. When the

reverse driving stops, the monitor return to its original input mode.

P.VOL Sub-menu Features

Setting	Options	Function
Source	iPod	Choose a source for which you would like to increase the relative volume (LEVEL).
	Disc	
	Radio	
	SAT	
	AUX IN1	
	AUX IN2	
Level	0-6	Increase relative volume for specified source up to 6 decibels.

TS Cal (Screen Calibration)

To access the "Screen Calibration" function from the SETUP menu, select the "TS CAL" option.

After entering calibration mode, a crosshair + appears in a corner quadrant of the screen. To begin calibration, press and hold the crosshair for one second until it moves to the next quadrant. Continue for each quadrant until the calibration is completed.

Exiting the System Setup Menu

To exit setup mode and resume normal playback, press the **SETUP** button (31) on the remote control or touch the **BACK** button on the screen.

TUNER OPERATION

Tuner TFT Display

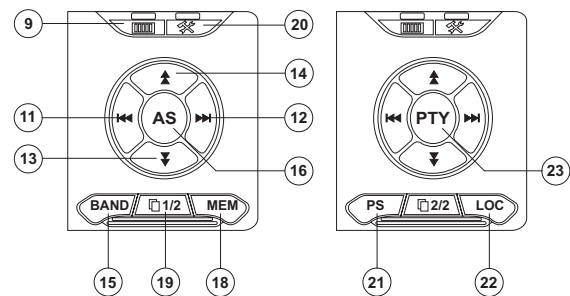
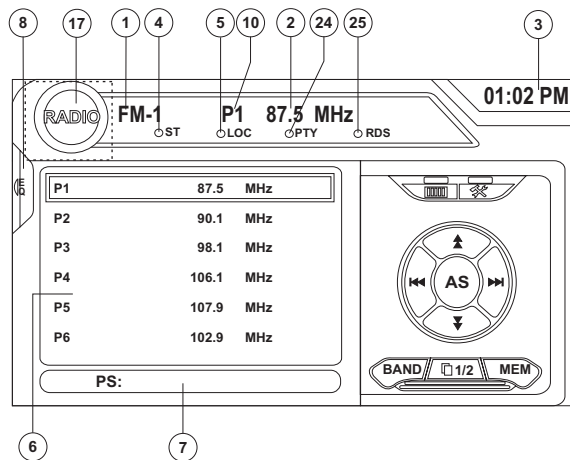

1. Current radio band indicator
2. Radio frequency indicator
3. Clock
4. Stereo broadcasting indicator
5. Strong Local signal broadcasting indicator
6. Preset radio stations: Touch to recall preset stations
7. RDS Information: PS (Program Service), PTY (Program Type), RT (Radio Text)
8. Touch for q23uick access to Equalizer level settings
9. Touch to access the direct entry screen
10. Current preset station indicator
11. <<<: Touch to seek backward
12. >>>: Touch to seek forward
13. <<: Touch to tune backward one step
14. >>: Touch to tune forward one step

15. **BAND**: Touch to change between AM/FM bands
16. **AS**: Touch to automatically store stations
17. Touch to view the **SOURCE MENU** and select a new playback source
18. **MEM**: View screen used to enter current channel into preset memory
19. **1/2** or **2/2**: Touch this page button to view a second page of on-screen buttons
20. : Touch to view the **SETUP** menu
21. **PS** (Preview Scan): Touch to scan all stations available, stopping for 5 seconds at each and continuing until a station is selected
22. **LOC**: Touch to tune to strong local stations
23. **PTY**: When **PTY** is pressed, the Program Type categories are listed, allowing listeners to find similar programming by genre. When a **PTY** category is selected from the touch screen menu, the radio will start scanning for the selected category.
24. Indicates the **PTY** function is activated
25. Indicates the **RDS** function is activated

Switch to Radio Tuner source

- Touch the top left corner of the screen (the **RADIO** circle) to view the **SOURCE MENU**. Touch "Radio".
- Press the **SRC** button (6) on the front panel or remote control (8) to switch to the AM/FM or RADIO source.

Select FM/AM Band

Touch the **BAND** button (15) on the screen, or press the **BAND** button on the unit (4) or remote control (20) to change between the following bands: FM1, FM2, FM3, AM1, and AM2.

NOTE: The BAND button on the unit only works when the TFT is closed.

Seek Tuning

To seek the next higher station:

- Touch the >>> button on screen.
- Press the >>> button (19) on remote control.
- Press the > button on the joystick (17).

To seek the next lower station:

- Touch the <<< button on screen.
- Press the <<< button (11) on the remote control.
- Press the < button on the joystick (16).

Manual Tuning

To increase or decrease the tuning frequency one step:

- Touch the or buttons on screen.
- Press the >> or << buttons (14, 22) on the remote control.
- Press the or buttons (18, 19) on the joystick.

Direct Tuning

To enter a radio station directly, touch the button or press the **GOTO** button (21) on the remote control to display the direct entry menu.

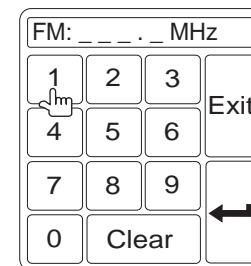

Enter the desired radio station using the on-screen number pad. Press the enter button (arrow) to tune to the selected station. To exit the screen without changing the station, touch **Exit**. To clear your entry and start over, touch **Clear**.

Using Preset Stations

Six numbered preset buttons store and recall stations for each band. All six stored stations (P1-P6) for the current band appear on the screen.

Storing a Station

1. Select a band (if needed), then select a station.
2. Touch the on-screen **MEM** button (18) to open the preset screen.

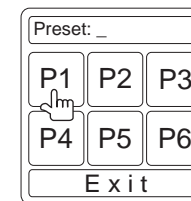

3. Touch the preset number in which you would like to store the current station (or press **EXIT** to cancel and close the menu). The preset number and station appears highlighted.

Recalling a Station

1. Select a band (if needed).
2. Touch an on-screen preset button (6) to select the corresponding stored station.

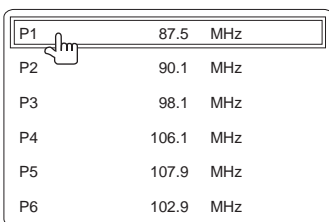

P1	87.5	MHz
P2	90.1	MHz
P3	98.1	MHz
P4	106.1	MHz
P5	107.9	MHz
P6	102.9	MHz

Auto Store (AS)

To select six strong stations and store them in the current band:

1. Select a band (if needed).
2. Press the **AS/PS** button (3) on the control panel or touch **AS** (16) on the screen for 2 seconds to activate the Auto Store function.

The new stations replace stations already stored in that band.

Preview Scan (PS)

To scan the AM or FM band for a preview of available stations in your particular area, touch the **PS** button (21) on page two of the on-screen controls. Touch again to stop preview scan.

Local Radio Station Seeking (LOC)

When the Local function is on, only radio stations with a strong local radio signal are played. To activate the Local function in AM/FM tuner mode, *press and hold* the **AUDIO/LO/DX** button (5) on the front panel. *Press and hold* **AUDIO/LO/DX** again to turn Local off. When the Local function is active, the LOC indicator at the top of the screen is illuminated.

SATELLITE RADIO OPERATION

Listeners can subscribe to XM® Radio on the Web by visiting www.xmradio.com, or by calling (800) 967-2346. Customers should have their Radio ID ready (see “Displaying the Identification (ID) Code”). Customers can receive a limited number of free-to-air channels without activation.

Listeners can subscribe to Sirius® Radio on the Web by visiting www.sirius.com, or by calling (888) 539-SIRIUS. Customers should have their Sirius ID ready (Sirius ID is located on the Satellite Radio Tuner, sold separately). Customers can listen to music samples by tuning to channel 184.

Accessing Satellite Radio Mode

Press the **SRC** button (8) on the front panel or remote control (8) to switch to the SAT source.

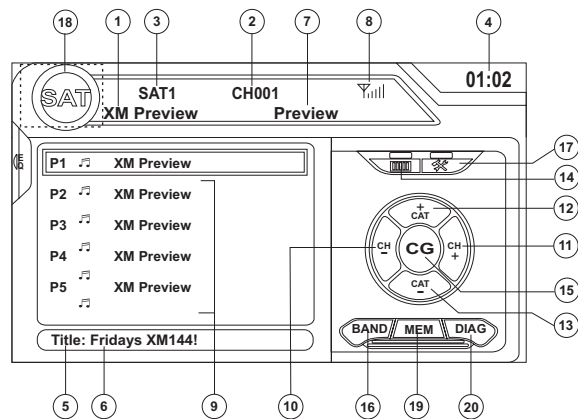

1. SAT channel name
2. SAT channel number
3. SAT band
4. Time
5. Song title
6. Artist name
7. Song category
8. Signal Strength Indicator
9. Current preset channels/on-screen preset buttons
10. **CH -**: Select the previous channel
11. **CH +**: Select the next channel
12. **CAT +**: Select next channel in current category only

13. **CAT -**: Select previous channel in current category only
14. Touch to enter channel directly using keypad on screen
15. **CG**: Access Channel/Category Guide mode
16. **BAND**: Change between SAT1, SAT2 and SAT3 bands
17. : Touch to view the SETUP menu
18. Touch this area to view the SOURCE MENU and select a new playback source
19. **MEM**: View screen used to enter current channel into preset memory
20. **DIAG**: This feature is reserved for use by service professionals for troubleshooting.

Displaying the Identification (ID) Code

Before you listen to satellite radio, you must subscribe to the service using your radio's identification number. To display the radio ID, press the < or > buttons (16, 17) on the joystick or the **CH -** or **CH +** buttons on the touch screen repeatedly to tune to channel "000". The screen displays the radio ID where the channel name is usually displayed.

Selecting a Station

Press the < or > buttons (16, 17) on the joystick, the |<< or >>| buttons (17, 19) on remote control, or the **CH -** or **CH +** buttons on the touch screen to change to another station.

Preset Mode

To enter preset mode, touch the **BAND** button on the screen, or press the **BAND** button on the unit (14) or remote control (20) to change between the following bands: SAT1, SAT2, or SAT3 (indicated in the top left corner of the TFT screen).

Six numbered preset buttons store and recall stations for each band. All six stored stations (P1-P6) for the current band appear on the TFT screen.

Storing a Station

1. Select a band (if needed), then select a station.
2. Touch the on-screen **MEM** button (18) to open the preset screen.

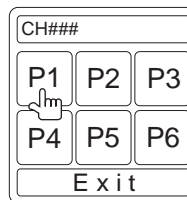

3. Touch the preset number in which you would like to store the current station (or press **EXIT** to cancel and close the menu). The preset number and station appears highlighted.

Recalling a Station

1. Select a band (if needed).
2. Touch an on-screen preset button to select the corresponding stored station.

Direct Tuning

To enter a radio station directly, touch the button or press the **GOTO** button (21) on the remote control to display the direct entry menu.

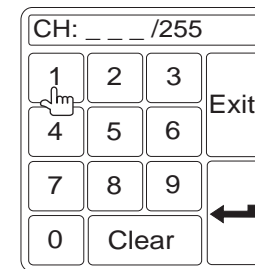

Enter the desired radio station using the on-screen number pad. Press the enter button (arrow) to tune to the selected station. To exit the screen without changing the station, touch **Exit**. To clear your entry and start over, touch **Clear**.

Channel/Category Guide Mode

There are two search modes to help navigate through channels and or categories. To access the Channel/Category Guide mode press, the **ZOOM** button (23) on the remote control or the **CG** button on the touch screen.

Channel Guide is the default search mode. To access Category Guide, press the **TITLE** button (2) on the remote control or touch **CAT** on the touch screen. To return to Channel Guide, touch **CH** on the screen or press the **SUBTITLE** button (9) on the remote control.

Channel Guide Mode

When Channel Guide mode is selected, the first six satellite channels are displayed in the boxes in the bottom left of the TFT screen and the on-screen menu changes to facilitate search mode.

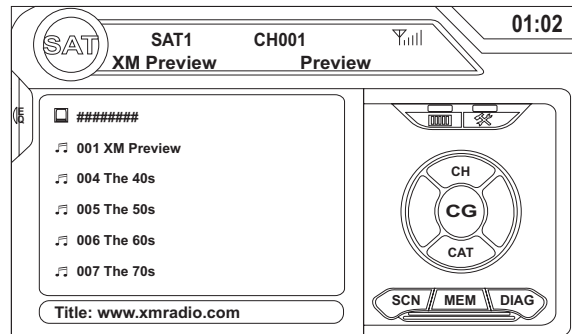

- While in Search Mode, to switch between Channel and Category search modes, press the **CH** or **CAT** buttons in the touch screen.
- Use the scroll bar and arrows on the touch screen to view the next/previous page of stations. Each page contains six channels to select from.
- Press the on-screen **SCN** button to preview each of the 6 channels displayed for 10 seconds.
- Press the **CG** button to return to the Preset Mode screen.
- To select a channel while in Channel Guide mode, touch the channel name on the screen. The channel will begin playing and the unit will return to the Preset Mode.

Category Guide Mode

When Category Mode is selected, folder icons appear on the screen next to category choices.

- While in Search Mode, to switch between Channel and Category search modes, press the **CH** or **CAT** buttons in the touch screen.
- Use the scroll bar and arrows on the touch screen to view the next/previous page of categories. Each page contains six categories to select from.
- To select a category, touch the corresponding category name or folder icon. The channels in that category will be displayed on the screen.
- Use the scroll bar and arrows on the touch screen to view the next/previous six stations in the selected category.
- Touch the on-screen **SCN** button to preview each channel in the selected category for 10 seconds.
- Touch the channel name to play that channel.
- Touch the on-screen **CG** button to return to the Preset Mode screen.

DVD/VCD VIDEO OPERATION

NOTE: When properly installed, DVD video cannot be displayed on the main TFT screen unless the parking brake is applied. If you attempt to play a DVD while the vehicle is moving, the TFT screen displays "PARKING" with a blue background. Rear video screens, if applicable, will operate normally.

Opening/Closing the TFT Video Screen

Opening the TFT Screen

To open the TFT video screen, press the **OPEN** button (1). The unit beeps and then opens.

Closing the TFT Screen

Press the **OPEN** button (1) again to close the TFT screen. If the screen is in the "IN" position, it moves out before closing.

Insert/Eject Disc

Upon inserting a DVD disc, DVD mode is entered and disc play begins.

NOTE: If Parental Lock (Rating) is activated and the disc inserted is not authorized, the 4-digit code must be entered and/or the disc must be authorized (see "General Sub-menu Features" on page 13).

You cannot insert a disc if there is already a disc in the unit or if the power is off.

NOTE: DVD-R and DVD-RW will not play unless the recording session is finalized and the DVD is closed.

Ejecting a Disc

Press the **▲** button (21) on the unit or remote control (35) to eject the disc. The unit automatically reverts to Tuner mode. You may eject a disc with the unit powered off. The unit will remain off after the disc is ejected.

Reset the Loading Mechanism

If the disc loads abnormally or an abnormal core mechanism operation occurs, press and hold the **▲** button (21) on the unit or remote control (35) to reset the loading mechanism. Normal operation resumes.

Accessing DVD Mode

To switch to DVD mode when a disc is already inserted, press the **SRC** button (15) on the front panel or remote control (8) until "DISC" appears at the bottom of the screen.

Using the Touch-Screen Controls

The touch key areas for DVD playback are outlined below.

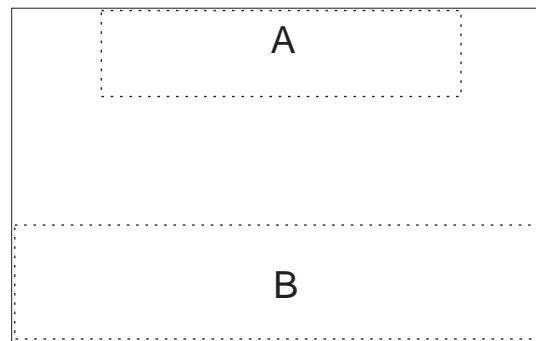

A – Displays playing information

B – Displays on-screen control menu

Controlling Playback

To access the on-screen controls, touch the bottom 1/3 of the screen (section B). Touch the **1/2** button to view a second page of controls

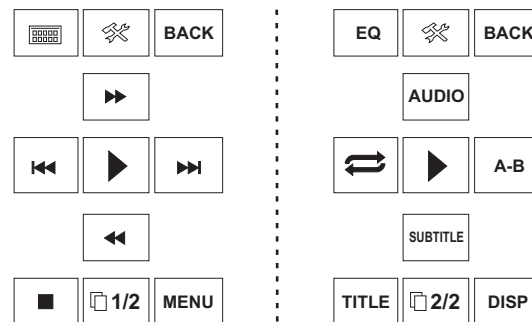

Stopping Playback

Touch the stop button (■) on the screen or press the **■/BAND** button (20) on the remote control to stop DVD play.

Pausing Playback

Touch the play/pause button (⏸) on the screen or press the **>/||** button on the remote control (18) to suspend or resume disc play.

Slow Motion Playback

Press the **<<** button (22) on the remote control, the **V** button (11) on the joystick, or the **<<** button on the screen to play the current title in slow motion. Keep pressing and releasing the button to increase the rate from "2X" to "4X", "8X", and "20X".

Press **>/||** (18) on the remote control or touch the onscreen play button (**>**) to resume normal play.

Fast Forward Playback

Press the **>>** button (14) on the remote control, the **Λ** button (15) on the joystick, or the **>>** button on the screen to fast forward. Keep pressing and releasing the button to increase the rate from "2X" to "4X", "8X", and "20X".

Press **>/||** (18) on the remote control or touch the onscreen play button (**>**) to resume normal play.

Repeat Playback

Press the **REPT** button (7) on the remote control or the **↺** button on screen to alter repeat mode according to the following:

- DVD: Repeat Chapter, Repeat Title, Repeat Off
- VCD (PBC Off): Repeat Single, Repeat Off

NOTE: For VCD play, the repeat function is not available if PBC is on.

Sectional Repeat Function (A-B)

Use the A-B function to define a specific area of a disc to repeat.

- Press the **REPT A-B** button (6) on the remote control (or the A-B button on screen) to set the start point (A) of the repeated section.
- Press the **REPT A-B** button again once you reach the desired end point (B) of the repeated section. The selected portion of the DVD will now repeat continuously.
- Press the **REPT A-B** button again to cancel the A-B section setting and stop repeat play.

Random Playback

With a DVD, VCD, or CD playing, press the **RDM** button (33) on the remote control to activate random playback and play all chapters/tracks in random order. "On" appears on the screen.

Press the **>>|** button (19) on the remote control or the **>** button on the joystick (17) to play the next random track.

Press the **RDM** button again to turn random play off.

NOTE: When a VCD is playing with PBC turned "On", activating random playback automatically turns PBC off.

Accessing the DVD Menu

Press the **MENU** button (1) on the remote control to recall the main DVD menu. Use the directional (arrow) buttons (<, >, A & V) on the joystick (16, 17, 18, 19) to select a title from the menu or touch the title on screen.

Press the **TITLE** button (2) on the remote control or on screen to select a different title for playback.

Press the >|| button (18) on the remote control or the **ENTER** (joystick) button (20) to confirm your selection and begin playback. You can also select a title using the touch screen.

Moving Through Chapters

Press the >>| button (19) on the remote control, the > button on the joystick (17) or the >>| button on screen to advance to the next chapter on the DVD.

Press the |<< button (17) on the remote control, the < button on the joystick (16), or the |<< button on screen to move to the previous chapter.

Goto Search

During DVD or VCD playback, perform the following steps to use the GOTO feature to access a specific location on a disc:

1. Press the **GOTO** button (21) on remote control to enter "GO TO" mode.
2. Press the >> or << buttons (14, 22) on the remote control or the < or > buttons (16, 17) on the joystick to select a category (highlighted in blue).
 - For DVD mode, you can choose Time or Title/Chapter search.

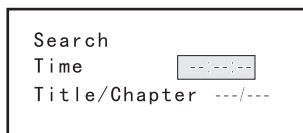

DVD Search

Time – Go to specific time in current title

Title/Chapter – Go to specific time in a chapter

- For VCD mode, press the **GOTO** button to choose between Track Search, Disc Search and Exit.

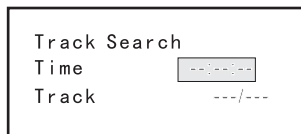

VCD Track Search

Time – Go to specific time in the current track

Track – Go to specific track



VCD Disc Search

Time – Go to specific time on disc

Track – Go to specific track

3. Enter a time into the field using the numeric keypad (29) on the remote control.
4. Press the >|| button (18) on the remote control or the **ENTER** (joystick) button (20) to go to the specified location on the disc.
5. Press the **GOTO** button again to exit.

Direct Chapter / Track Selection

Remote Control Direct Entry

During DVD, VCD and CD playback, you can use the numeric keypad on the remote control (29) to access a track directly.

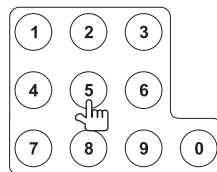

Touch Screen Direct Entry

To select a chapter/track directly, touch the button on screen control to display the direct entry menu.

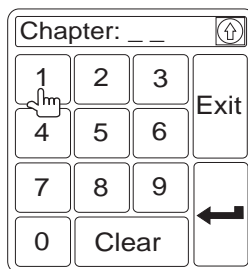

Enter the desired chapter/track using the on-screen number pad. Press the enter button (arrow) to tune to the selected station. To exit the screen without changing the station, touch **Exit**. To clear your entry and start over, touch **Clear**.

Viewing an Alternate Picture Angle (DVD Only)

Some DVDs contain scenes that have been shot simultaneously from different angles. For discs recorded with multiple angles, press the **ANGLE** button (13) on the remote control to toggle available angles of the on-screen image.

Zooming

Press the **ZOOM** button (23) on the remote control to enlarge and pan through the video image using the following options: "Q1", "Q2", "Q3", and "OFF".

Multi-Language Discs (DVD Only)

Changing Audio Language

If you are watching a disc recorded in multiple languages, press the **AUDIO** button (5) on the remote control to choose a language.

Changing Subtitle Language

If you are watching a disc recorded in multiple languages with subtitles, press the **SUBTITLE** button (9) on the remote control to choose the language in which you would like the subtitles to appear.

NOTE: During VCD playback, press the AUDIO button (5) on the remote control to choose between Left Channel, Right Channel, and Stereo.

PBC (Play Back Control - VCD Only)

For VCDs with play back functionality, play back control (PBC) provides additional controls for VCD playback.

Press the **MENU** button (1) on the remote control to toggle the PBC function "On"/"Off". Once PBC is on, playback starts from track one of the play list.

NOTE: When PBC is activated, fast forward, slow playback, and previous/next track are available. Repeat and direct track selection are not available.

When PBC is activated, selecting random, scan, or search playback automatically deactivates PBC.

Playback Information

During DVD and VCD playback, press the **INFO** button (10) on the remote control to display playback information on the

screen, including the media playing and current playback time.

DVD Playback Information

The following information is displayed at the top of the screen during DVD playback:

DVD T : 5/8 C : 2/16 00:41:28 2/6 Eng

- T : 5/8 – “5 / 8” indicates the fifth of 8 titles on the DVD is currently playing.
- C : 2/16 – “2 / 16” indicates that the second of 16 titles on the DVD is currently playing.
- 00:41:28 – “00:41:28” indicates the playback time of the current title.
- 2 / 6 Eng – The language display information indicates the second language out of 6 (English) is currently being used.

VCD Playback Information

The following information is displayed at the top of the screen during VCD playback:

VCD2.0 T: 6/18 00:02:18

- VCD2.0 – Format of current disc.
- T: 6/18 – “6/18” indicates the sixth of 18 tracks on the VCD is currently playing.
- 00:02:18 – “00:02:18” indicates the playback time of the current track.

General Disc Information

Table 5: Disc Properties

Symbol	12cm Disc Properties	Max Play Time
	Single side single layer (DVD-5) Single side double layer (DVD-9) Double side single layer (DVD-10) Double side double layer (DVD-18)	(MPEG 2 Method) 133 minutes 242 minutes 266 minutes 484 minutes
	Single side single layer (VCD)	(MPEG 1 Method) 74 minutes
	Single side single layer	74 minutes

Table 6: Disc Symbols

Symbol	Meaning
	Number of voice languages recorded. The number inside the icon indicates the number languages on the disc (maximum of 8).
	Number of subtitle languages available on the disc (maximum of 32).
	Number of angles provided (maximum of 9).
	Aspect ratios available. “LB” stands for Letter Box and “PS” stands for Pan/Scan. In the example on the left, the 16:9 video can be converted to Letter Box video.
	Indicates the region code where the disc can be played. <ul style="list-style-type: none"> • Region 1: USA, Canada, East Pacific Ocean Islands • Region 2: Japan, Western Europe, Northern Europe, Egypt, South Africa, Middle East • Region 3: Taiwan, Hong Kong, South Korea, Thailand, Indonesia, South-East Asia • Region 4: Australia, New Zealand, Middle and South America, South Pacific Ocean Islands/Oceania • Region 5: Russia, Mongolia, India, Middle Asia, Eastern Europe, North Korea, North Africa, North-West Asia • Region 6: Mainland China • ALL: All regions

DVD/CD AUDIO OPERATION

Instructions for TFT control and Insert/Eject are the same for DVD and CD operation. Please see the DVD/Disc Video Operation section for information about these topics.

The VM9312 will play music or other audio files from the following disc media:

- CD-DA
- CD-R/RW
- DVD
- DVD+R/RW
- DVD-R/RW

Upon inserting a disc with the TFT screen open, the disc and track title (if available), along with the track number and playing time appear on the screen.

CD Player User Interface

The on-screen indicators and touch key areas for CD playback are outlined below.

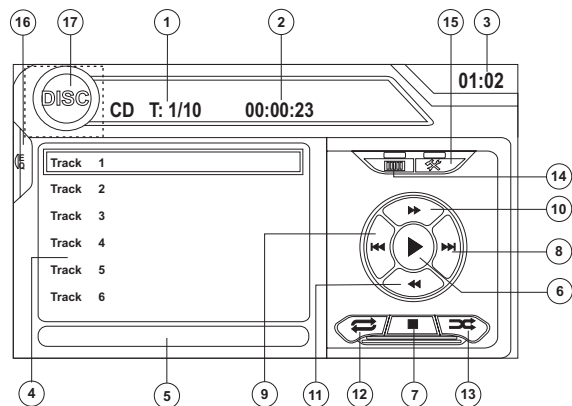

1. Current track and total number of tracks on disc
2. Elapsed playing time
3. Current time
4. Track titles
5. Disc title
6. ►: Touch to play/pause disc playback
7. ■: Touch to stop disc playback
8. >>|: Touch to move to next track
9. |<<: Touch to move to previous track
10. >>: Touch to fast forward current track
11. <<: Touch to rewind current track
12. Touch to activate/deactivate Repeat play mode
13. Touch to activate/deactivate Random mode

14. Touch to access the direct entry screen
15. ⚙️: Touch to view the SETUP menu
16. Touch for quick access to Equalizer level settings
17. Touch to view the SOURCE MENU and select a new playback source

Controlling Playback

Stopping Playback

Touch the ■ button on screen or press the ■/BAND button (20) on the remote control to stop disc play.

To resume playback, touch the ► button on screen, press the joystick button (13) on the front panel, or press the >|| button on the remote control (18).

Pausing Playback

Touch the ► button on screen, press the joystick button (13) on the front panel, or press the >|| button on the remote control (18) to suspend or resume disc play.

Moving Through Tracks

Press the >>| button (19) on the remote control or on screen or use the > button on the joystick (14) to advance to the next track on the disc.

Press the |<< button (17) on the remote control or on screen or use the < button on the joystick (10) to move to the previous track.

Repeat Playback

Touch the ⇄ button on screen or press the REPT button (7) on the remote control to alter repeat mode according to the following:

- DVD: Repeat Chapter, Repeat Title, Repeat Off
- CD-DA: Repeat Single, Repeat Off
- CD-R/RW: Repeat Single, Repeat Off
- DVD-R/RW: Repeat Single, Repeat Off

Track Scan Select (CD-DA discs only)

During disc play, press the SCN button (34) on the remote control to play the first 10 seconds of each track. When a desired track is reached, press the SCN button again to cancel the function and play the selected track.

Random Play Select

While disc play is stopped, touch the ⚡ button on screen or the RDM button (33) on the remote control to play the tracks on the disc in a random, shuffled order. Touch the ⚡ (RDM) button again to cancel Random Play mode.

NOTE: CD-R and CD-RW will not play unless the recording session is finalized.

Fast Forward

Touch the >> button on screen, press the >> button (14) on the remote control, or press the Λ button (18) on the joystick to fast forward. Keep pressing and releasing the button to increase the rate from "2X" to "4X", "8X", and "20X".

Direct Track Entry

To select a track directly, touch the [0-9] button on screen control to display the direct entry menu.

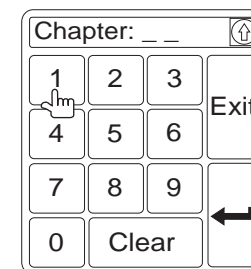

Enter the desired track using the on-screen number pad. Press the enter button (arrow) to tune to the selected station. To exit the screen without changing the station, touch **Exit**. To clear your entry and start over, touch **Clear**.

MP3/WMA OPERATION

Instructions for TFT control and Insert/Eject are the same for DVD and MP3 operation. Please see the DVD/Disc Video Operation section for information about these topics.

Media and File Requirements

This player allows you to play back MP3 and WMA files recorded onto CD-R/RWs, DVD+R/RWs, and DVD-R/RWs. For CD-RW discs, please make sure it is formatted using the full method and not the quick method to prevent illegal disc operation.

Up to 1500 songs/files can be burned onto a disc for a MEGA DVD music mix. Do not exceed this number of songs/files or disc readability problems may occur.

MP3 Format Compatibility

The file naming formats listed below are compatible with this unit:

- ISO 9660 – file name: 12 characters, file extension: 3 characters
- ISO 9660 – file name: 31 characters, file extension: 3 characters
- Joliet – 64 characters

If the file or folder name does not conform to ISO 9660 file system standards, it may not be displayed or played back correctly. Use the following settings when compressing audio data for your MP3 disc:

- Transfer Bit Rate: 128kbps
- Sampling Frequency: 48kHz

When recording MP3 up to the maximum disc capacity, disable additional writing. For recording on an empty disc up to maximum disc capacity, use the "Disc at once" setting.

MP3 Playing Order

When selected for play, files and folders (Folder Search, File Search or Folder Select) are accessed in the order they were written by the CD writer. As a result, the order in which they are expected to be played may not match the order in which they are actually played. You may be able to set the order in which MP3/WMA files are to be played by writing them onto a medium such as a CD-R with their file names beginning with play sequence numbers such as "01" to "99".

For example, a medium with the following folder/file hierarchy is subject to Folder Search, File Search or Folder Select, as shown below.

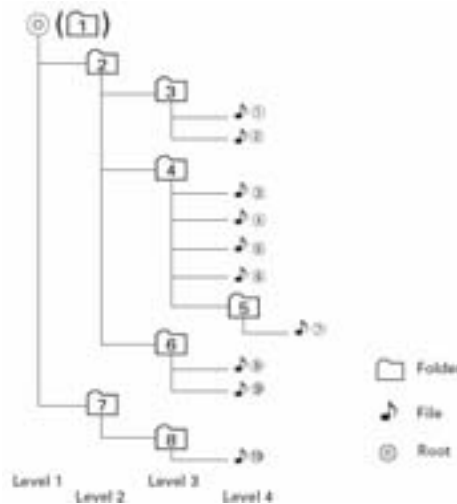

The VM9312 player will only recognize three folder levels and does not display folders containing only other folders. In the example above, the unit will display folders 3, 4, 6, and 8, but not 2 and 7 since they do not contain any tracks directly. Folder 5 is not recognized at all since it is at the fourth level.

MP3 Player User Interface

The on-screen indicators and touch key areas for MP3 playback are outlined below.

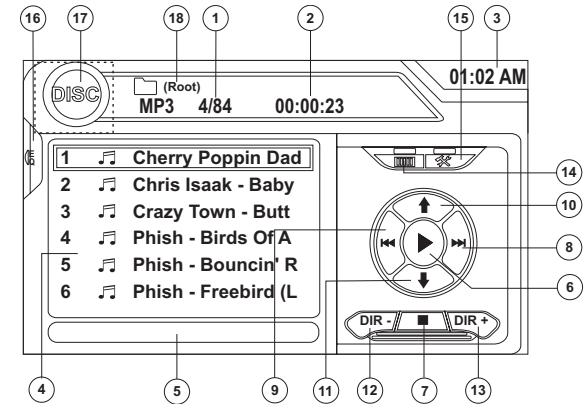

1. Current track and total number of tracks on disc
2. Elapsed playing time
3. Current time
4. Track titles
5. ID3 information
6. ►: Touch to play/pause disc playback
7. ■: Touch to stop disc playback
8. >>|: Touch to move to next track
9. |<<: Touch to move to previous track
10. ↑: Touch to view the next page of songs
11. ↓: Touch to view the previous page of songs
12. DIR -: Touch to view the previous folder
13. DIR +: Touch to view the next folder
14. Touch to access the direct entry screen
15. ⚙️: Touch to view the SETUP menu
16. Touch for quick access to Equalizer level settings
17. Touch to view the SOURCE MENU and select a new playback source
18. Folder name



Controlling Playback



Playing MP3/WMA Files

After inserting a MP3/WMA disc, files will play in the sequence of the "Root" directory.



NOTE: When burning MP3 / WMA files onto a DVD disc, use the 2X or 4X burning option, if available. This slower burning speed will help eliminate buffer errors and increase disc reading reliability. Also, use folders when burning large numbers of songs / files to a disc for easy music navigation. Select the "Disc at Once" option and close your disc.

Stopping Playback



Touch the  button on screen or press the  /BAND button (20) on the remote control to stop disc play.



To resume playback, touch the  button on screen, press the joystick button (13) on the front panel, or press the  button on the remote control (18).

Pausing Playback

Touch the  button on screen, press the joystick button (13) on the front panel, or press the  button on the remote control (18) to suspend or resume disc play.

Moving Through Tracks

Press the  button (19) on the remote control or on screen or use the  button on the joystick (14) to advance to the next track on the disc.

Press the  button (17) on the remote control or on screen or use the  button on the joystick (10) to move to the previous track.

Repeat Playback

Touch the  button on screen or press the REPT button (7) on the remote control to alter repeat mode according to the following: Repeat Single, Folder Repeat, Repeat Off

Random Play Select

Press the RDM button (33) on the remote control to play the files on the disc in a random, shuffled order. Press RDM again to cancel Random Play mode.

NOTE: CD-R and CD-RW will not play unless the recording session is finalized.

Direct Track Entry

Use the numeric keypad (29) on the remote control to access files directly or press the  button (see "Direct Track Entry" on page 22).

IPOD OPERATION

NOTE: Be sure your iPod has the latest Apple firmware installed to avoid connectivity issues.

Accessing iPod Mode

The unit will automatically switch to iPod mode when an iPod is plugged into the MediaLink. To return to the iPod menu from any other source menu, press the **SRC** button (6) on the front panel or remote control (8) until the iPod menu appears on the screen. The on-screen indicators and touch key areas for iPod playback are outlined below.

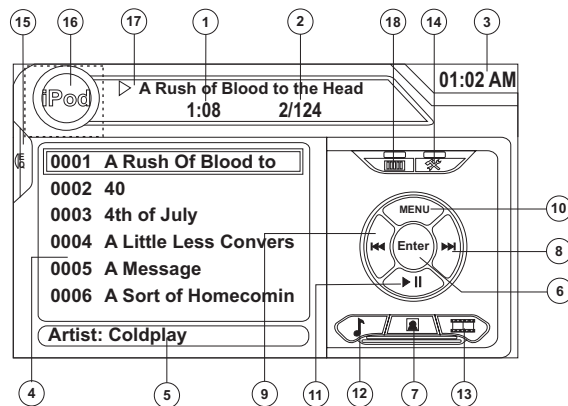

1. Elapsed playing time for current file
2. File number and total number of files on the disc
3. Current time
4. File titles
5. ID3 information (Artist/Album)
6. Touch to "Enter"
7. Touch to access the Photo menu
8. >>|: Touch to move to next track
9. |<<: Touch to move to previous track
10. **MENU**: Touch to view the iPod main menu
11. ▶||: Touch to play/pause disc playback
12. Touch to access the Music menu
13. Touch to access the Video menu
14. ⚙️: Touch to view the SETUP menu
15. Touch for quick access to Equalizer level settings
16. Touch to view the SOURCE MENU and select a new playback source
17. Current file title
18. Touch to access the direct entry screen

Controlling your iPod

Touch the **MENU** button to access the main iPod menu. The following touch screen icons and remote control buttons are used to access the iPod menus:

Menu	Touch Screen	Remote Control
Music		TITLE
Photos		MENU
Videos		AUDIO

Use the touchscreen, the joystick, or the directional keys on the remote control to navigate the iPod menus.

Music Playback

To access music files, touch the button on screen or press the **TITLE** button (2) on the remote control.

- Touch the > || button on screen to play/pause.
- Touch >>| on screen, press the >>| button (19) on the remote control, or press the > button on the joystick (17) to move to the next item on the menu.
- Touch |<< on screen, press the |<< button (17) on the remote control, or press the < button on the joystick (16) to move to the previous item on the menu.
- Use the touch screen or press the >|| button (18) on the remote control or the joystick **ENTER** button (20) on the head unit to select the highlighted menu option.
- Press the >> button (14) on the remote control or the **Λ** button (18) on the joystick, or touch the **MENU** button on screen, to return to the previous menu.

Fast Forward/Fast Reverse

Press and hold the |<< or >>| buttons on screen or on the remote control (17, 19) for 1 second and continue to hold for fast forward or fast reverse. Release to resume normal play.

Search Playlist/Artist/Album/Song

To search through Playlists, Artists, Albums and Songs, press the **1** button (29) on the remote control keypad while in one of the following directories: Playlist, Artist, Album or Song. The selected directory will be accessed with the number of pages and files in that directory displayed at the top of the page. To access the page or file, enter the page or file number directly from the remote control keypad. Press the |<< or >>| button (17, 19) on the remote control or the < or > button (16, 17) on the joystick to select the desired song or file.

Direct Track Entry

To select a track directly, touch the button on screen control to display the direct entry menu.

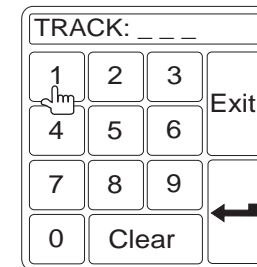

Enter the desired track using the on-screen number pad. Press the enter button (arrow) to tune to the selected station. To exit the screen without changing the station, touch **Exit**. To clear your entry and start over, touch **Clear**.

Photo Playback

While iPod photos can be viewed on the VM9312 screen, you must use the iPod to control photo playback options.

Touch the icon on screen or press the **MENU** button (1) on the remote control to access the iPod PHOTO mode. The VM9312 will release control back to the iPod so you can select video media to be displayed on the TFT monitor. To exit PHOTO mode, touch the screen.

Video Playback

While iPod video can be viewed on the VM9312 screen, you must use the iPod to control video playback options.

Touch the button on screen or press the **AUDIO** button (5) on the remote control to access iPod VIDEO mode. The VM9312 will release control back to the iPod so you can select video media to be displayed on the TFT monitor. To exit VIDEO mode, touch the screen, press the >> button (14) on the remote control, or press the **MENU** button on the iPod.

NOTE: To transmit the video from your iPod to the VM9312 screen, you must set the following options through the iPod video settings menu: TV Out = On, TV Signal = NTSC, and Widescreen = On.

NOTE: After disconnecting your iPod, the VM9312 will always return to the last mode accessed when the iPod is plugged back into the unit.

TROUBLESHOOTING

Table 7: Troubleshooting

Problem	Cause	Corrective Action
GENERAL		
Unit will not power on	Radio Fuse blown	Install new fuse with correct rating
	Car battery fuse blown	Install new fuse with correct rating
	Illegal operation	Press the RESET button located in the bottom right corner of the front panel
Remote control does not function	Battery depleted	Replace battery with new one
	Battery installed incorrectly	Remove battery and install correctly
No/low audio output	Improper audio output connection	Check wiring and correct
	Volume set too low	Increase volume level
	Improper "MUTE" connection	Review wiring diagram and check "MUTE" connection
	Speakers damaged	Replace speakers
	Heavily biased volume balance	Adjust the channel balance to the center position
	Speaker wiring is in contact with metal part of car	Insulate all speaker wiring connections
Poor sound quality or distortion	Pirated disc is in use	Use original copy
	Speaker power rating not compatible with unit	Connect proper speakers
	Speaker is shorted	Check speaker contact
Tel-Mute malfunction	"MUTE" wire is grounded	Check that "MUTE" connection is not grounded and that it's properly insulated
Unit resets itself when engine is off	Incorrect connection between ACC and positive battery wire	Check wiring and correct
TFT MONITOR		
Monitor does not open automatically	TFT Auto Open is turned off	Turn TFT Auto Open on
No image	Incorrect connection to parking brake wire	Check wiring and correct
	PRK SW is activated and parking brake is not engaged	Stop vehicle in safe place and apply parking brake
Flashing image or interference appears on screen	DVD is not compatible with current TV system settings	Change setup to accommodate disc
	Improper video signal connections	Check wiring and correct
Prolonged image or improper height/width ratio display	Improper aspect ratio setup	Use correct aspect ratio setting
Monitor stops at incorrect position	Moving path is blocked	Press OPEN key to restart monitor movement
TUNER		
Weak station searching	Auto antenna is not fully extended	Connect the auto antenna control cable properly
	Auto antenna not properly connected	Connect the auto antenna control cable properly
	LOCAL function is activated	Turn LOCAL function off
Cannot insert disc	Disc already inside unit	Eject current disc and insert new one

Table 7: Troubleshooting

Problem	Cause	Corrective Action
Disc does not play back	Disc is warped or scratched	Use disc in good condition
	Disc is dirty or wet	Clean disc with soft cloth
	Laser pickup is dirty	Clean laser pickup with cleaning disc
	Incompatible disc is used	Use compatible disc
	Disc rating exceeds Parental Lock rating limit	Change Parental Lock settings to lower restriction
	Disc region code is not compatible with unit	Use disc with proper region code
	Disc is inserted upside down	Insert disc with label side up
Image blurred, distorted, or dark	Disc is illegally copied	Use original disc
PBC cannot be used during VCD playback	PCB is not available on the disc	
No repeat or searching while playing VCD	PCB is on	Turn PCB off
MP3		
Interruption occurred during playback	Disc is dirty or scratched	Clean disc or replace
	File is damaged/bad recording	Recreate disc with good files
Incorrect playback message displayed	Message is longer than LCD can display	
SAT RADIO		
No Sound	Incorrect cable connections	Check RCA cables
Satellite source not available	Incorrect cable connections	Check Satellite Data cable
"ANTENNA" appears on the Satellite radio main screen	Antenna not connected	Check satellite antenna connection
IPOD		
iPod source not available	Incorrect cable connections	Check jLink and MediaLink cables
Cannot see video and photo media on TFT screen	Wrong iPod Video Settings	Change iPod video settings to TV Out = On

Error Messages

Table 8: Error Messages

Message Displayed	Cause	Corrective Action
Loading	Disc is being read	
No Disc	Disc is dirty	Clean disc with soft cloth
	Disc is upside down	Insert disc with label side up
	Disc not present in loading compartment	Insert disc
Bad Disc	Disc is dirty	Clean disc with soft cloth
	Disc is upside down	Insert disc with label side up
Unknown disc	Disc format is not compatible with this unit	
Region Error	DVD is not compatible with region code of unit	

Table 8: Error Messages

Message Displayed	Cause	Corrective Action
Error	Illegal mechanism operation	Press EJECT key for 5 seconds to reset loading mechanism

Care and Maintenance

1. Use only a clean silicone cloth and neutral detergent to clean the front panel or monitor. A rough cloth and non-neutral detergent (such as alcohol) may result in scratching or discoloration.
2. Do not get water or cleaning fluids on the unit.
3. If the temperature inside the player gets too hot, a protective circuit automatically stops play of the disc. If this occurs, allow the unit to cool before operating the player again.
4. Never insert anything other than a 5" (12 cm) compact disc into the player as the mechanism can be damaged by foreign objects.
5. Do not attempt to use a 3" (8 cm) CD-Single disc in this unit, either with or without an adaptor, as damage to the player and/or disc may occur. Such damage is not covered by the Warranty on this product.
6. The CD player may not operate properly in extreme hot or cold. If such conditions occur, allow the interior of the vehicle to reach a normal temperature before using player.
7. When the vehicle warms up during cold weather or under damp conditions, condensation may appear on the LCD panel. Should this occur, the screen will not operate properly until the moisture has evaporated.
8. We suggest you use a cleaning disc in this unit more frequently than in the unit in your home due to the environmental conditions of the vehicle.

SPECIFICATIONS

DVD/CD Player

Compatible Disc Media: DVD + R / RW (Single and Dual Layer) and CD-R / RW
 Compatible Media Formats: CD-DA, MP3, WMA, VCD, SVCD, AVI, MPEG1 / 2, XviD, DivX and Kodak picture CD (JPEG).

Signal to Noise Ratio: >95dBA

Dynamic Range: >95dB

Frequency Response: 20Hz to 20 kHz, -3dB

Channel Separation: > 60dB @ 1 kHz

D/A Converter: High performance 24-bit / 192 kHz sample rate, Multi-Bit Sigma-Delta Modulator

Video

Format: NTSC, PAL (auto-detection)

Output: 1Vp-p (75-ohm)

Input: 1Vp-p (75-ohm)

FM Tuner

Tuning Range: 87.5MHz - 107.9MHz

Mono Sensitivity (-30dB): 9dBf

Quieting Sensitivity (-50dB): 15dBf

Alternate Channel Selectivity: 70dB

Signal to Noise Ratio @ 1 kHz: 58dB

Image Rejection: 80dB

Stereo Separation @ 1 kHz: >30dB

Frequency Response: 30Hz - 15 kHz, -3dB

AM Tuner

Tuning Range: 530 kHz - 1720 kHz

Sensitivity (-20dB): 15uV

Signal to Noise Ratio @ 1 kHz: 50dB

Image Rejection: 60dB

Frequency Response: 50Hz - 2 kHz, -3dB

Monitor

Screen Size: 7.0" (Measured diagonally), 16:9 Widescreen

- 6.06" (154.1mm) W X 3.42" (87mm) H

Screen Type: TFT Liquid Crystal Display (LCD) active matrix

Response Time: 30mSec rise time, 50mSec fall time

Resolution:

- 336,960 sub pixels, 1440 (W) X 234 (H)

Viewing angle:

- 65 degrees left or right
- 40 degrees up
- 65 degrees down

General

Auxiliary Input impedance: 10k

Power Supply: 11 to 16VDC, negative ground

Power Antenna (Blue): 500mA max, current limited protection

Amplifier Remote (Blue/White): 500mA max, current limited protection

Operating Temperature: -20C ~ 65C

Fuse: 15-amp, mini ATM type

DIN chassis dimensions: 7" X 7" X 2" (178mm x 178mm x 50mm)

CEA Power Ratings



Power Output: 13 Watts RMS x 4 channels into 4-Ohms @ < 1% THD+N

Signal to Noise Ratio: 70dBA below reference (Reference: 1 Watt, 4-Ohms)

Frequency Response: 20 Hz - 20 kHz, -3dB. (Aux Input used as reference input)

Reference Supply Voltage: 14.4VDC

**Specifications subject to change without notice.*

Limited Warranty

CD or Multimedia Radios/Headunits

DO NOT RETURN THIS PRODUCT TO THE STORE

Audiovox Electronics Corporation (“the Company”) is committed to quality and customer service, and are pleased to offer you this Warranty. Please read it thoroughly and contact the Company at 1-800-323-4815 with any questions.

Who is covered?

The Company extends this warranty to the original retail purchaser of products purchased through an authorized Audiovox retailer in the U.S.A., Puerto Rico or Canada. This warranty is not transferable or assignable. Proof of purchase is required in the form of an original sales receipt.

What is covered?

The Company warrants that should this product or any part thereof, under normal use, be proven defective in material or workmanship within 12 months from the date of original purchase, such defect(s) will be repaired or replaced with a new or reconditioned product (at the Company's option) without charge for parts and repair labor.

What is not covered?

This Warranty *does not* cover the following:

- Damage incurred during shipping or transporting the product to the Company or a service center
- Elimination of car static or motor noise
- Defects in cosmetic, decorative or non-operative structural parts
- Correction of antenna problems
- Costs incurred for installation, removal or reinstallation of the product
- Consequential damage to compact discs, USB devices, digital media cards, accessories or vehicle electrical systems
- Damage caused by improper installation, mishandling, misuse, neglect, accident, blown fuse, battery leakage, theft or improper storage
- Products whose factory serial number/bar code label(s) or markings have been removed or defaced
- Damage resulting from moisture, humidity, excessive temperature, extreme environmental conditions or external natural causes

Please review the “Care and Maintenance” section of your Installation and Operation Manual for additional information regarding the proper use of your product.

Limitations

THE EXTENT OF THE COMPANY'S LIABILITY UNDER THIS WARRANTY IS LIMITED TO THE REPAIR OR REPLACEMENT PROVIDED ABOVE AND, IN NO EVENT, SHALL THE COMPANY'S LIABILITY EXCEED THE PURCHASE PRICE PAID BY PURCHASER FOR THE PRODUCT.

This Warranty is in lieu of all other express warranties or liabilities. ANY IMPLIED WARRANTIES, INCLUDING ANY IMPLIED WARRANTY OF MERCHANTABILITY, SHALL BE LIMITED TO THE DURATION OF THIS WRITTEN WARRANTY. ANY ACTION FOR BREACH OF ANY WARRANTY HEREUNDER INCLUDING ANY IMPLIED WARRANTY OF MERCHANTABILITY MUST BE BROUGHT WITHIN A PERIOD OF 24 MONTHS FROM DATE OF ORIGINAL PURCHASE. IN NO CASE SHALL THE COMPANY BE LIABLE FOR ANY CONSEQUENTIAL OR INCIDENTAL DAMAGES FOR BREACH OF THIS OR ANY OTHER WARRANTY, EXPRESS OR IMPLIED, WHATSOEVER. No person or representative is authorized to assume for the Company any liability other than expressed herein in connection with the sale of this product.

Some states do not allow limitations on how long an implied warranty lasts or the exclusion or limitation of incidental or consequential damage so the above limitations or exclusions may not apply to you. This Warranty gives you specific legal rights and you may also have other rights which vary from state to state.

Obtaining Warranty Service

- To obtain repair or replacement within the terms of this Warranty, call 1-800-323-4815 for the location of a warranty station serving your area.
- You must prepay the initial shipping charges to the Company. The Company will pay the return shipping charges for all warranted products returned to an address within the U.S.A., Puerto Rico or Canada.
- Please package the product securely to avoid shipping damage. We recommend using a carrier that provides tracking service to prevent lost packages. Lost or damaged packages are not covered by this warranty.
- Provide a detailed description of the problem(s) for which you require service.

if it's too
LOUD
you're too
OLD!



Audiovox Electronics Corporation
Hauppauge, NY 11788
Technical Assistance: 1-800-323-4815
www.jensen.com

© 2007 Audiovox
Ver. 020107
Printed in China

Free Manuals Download Website

<http://myh66.com>

<http://usermanuals.us>

<http://www.somanuals.com>

<http://www.4manuals.cc>

<http://www.manual-lib.com>

<http://www.404manual.com>

<http://www.luxmanual.com>

<http://aubethermostatmanual.com>

Golf course search by state

<http://golfingnear.com>

Email search by domain

<http://emailbydomain.com>

Auto manuals search

<http://auto.somanuals.com>

TV manuals search

<http://tv.somanuals.com>