

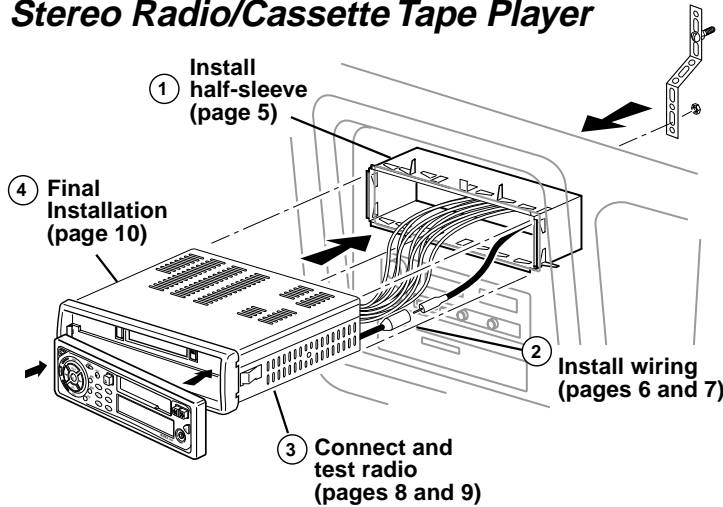

JENSEN®

How to Install the CR560X AM/FM Stereo Radio/Cassette Tape Player



Welcome!

What you're holding in your hands is no ordinary owner's manual. We've tried to make the instructions in this book clear and easy to follow.

For your Jensen stereo to work right, it must be installed correctly. This manual will show you how to install your new stereo like a pro. It's a good idea to read all of these instructions before you begin the installation. Most installations are straightforward and can be handled by a do-it-yourselfer with the right tools, patience, and the ability to follow instructions. But, do-it-yourself installation isn't for everyone. If you still don't feel confident after reading this book, consider turning the installation job over to someone better suited to it.

Warranty Service

If your Jensen stereo should ever require service, you will need to have the original dated receipt. If you ever need to return the unit for any reason, always include the receipt with the product.



Technical Assistance

For technical assistance with the installation of the CR560X, call 1-800-323-0221.

Installation

Contents

| | |
|--|----|
| Installation | 2 |
| Before You Begin Installation | 2 |
| Tools and Supplies Needed | 2 |
| Speaker Requirements | 2 |
| Adapters for Easier Installation | 2 |
| • Connections | 3 |
| • Crimp Connections | 3 |
| • Upgrading your System | 3 |
| Disconnect Battery | 4 |
| Remove Old Radio | 4 |
| Install Half-sleeve | 5 |
| Wiring | 5 |
| • Fuse Adapters | 5 |
| • Cars with a Single Speaker Wire | 5 |
| Wiring with a Wiring Adapter | 6 |
| Connect Wires | 6 |
| Install Wiring Inside the Car | 6 |
| Wiring Diagram—Advanced Installation | 7 |
| Testing | 8 |
| Reconnect Battery | 8 |
| Test Power Wiring | 8 |
| Test Antenna Connection | 8 |
| Test Memory Wiring | 8 |
| Set the Clock | 8 |
| Test Speaker Connections | 9 |
| Final Installation | 10 |
| Final Installation—ISO-DIN | 10 |
| Troubleshooting | 11 |
| Removing Radio from Dash | 11 |
| • Securing Wires | 11 |
| Specifications and Warranty | 12 |



Installation

Before You Begin Installation

Before you begin, you will need tools, supplies and adapters. It is best to make sure you have everything you need before you take your dashboard apart.

Tools and Supplies Needed

Basic Installation:

- Flat and Phillips screwdrivers
- Wire cutter
- Wire stripper
- Tools to remove existing radio (screwdriver, socket wrench set or other tools)
- Radio removal tool
- Electrical tape

Advanced Installation:

- Soldering iron
- Crimping tool
- Volt meter or 12 volt test light
- Solder
- Crimp connectors
- 14-18 gauge wire for power connections
- Speaker wire

Adapters for Easier Installation

Electrical and dashboard adapters make installation easier. Purchase adapters from your local Jensen retailer, electronics store or car stereo specialty store.

Wiring Harness Adapter

For a basic installation, you can purchase a wiring harness adapter for your car's existing radio connectors. This makes installation easy.

Dashboard Adapters

The opening in your dashboard may not match the size of your Jensen radio. Purchase an adapter kit for your car.

Antenna Adapter (GM cars)

1990 and newer GM cars have a small antenna connector. You will need an adapter when installing this radio in a newer GM car.

Speaker Requirements

Only connect the CR560X to speakers rated in the load impedance range of 4 to 8 ohms. Speakers with a load impedance less than 4 ohms could damage the CR560X.

Professional Tip**Connections**

Good wire connections are very important for best sound and long-term reliability. Here are two methods:

Splice

1. Strip 1/2 inch (12 mm) of insulation from both wires.
2. Wrap wires together
3. Fold wires over
4. Stretch electrical tape tightly over splice.

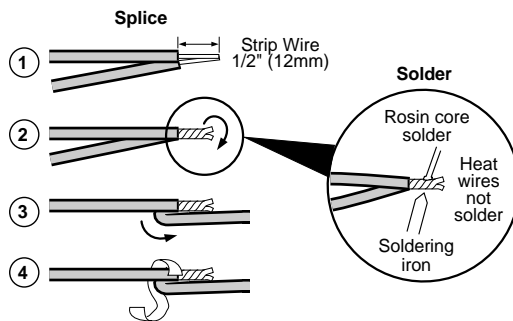
**Solder**

Solder is the best way to connect wires, but it takes skill and practice. Splice the wires (as shown above). Before taping, heat the wires (not the solder). When the wires are hot enough, touch the solder to the splice. The solder will flow over the wires. Stretch electrical tape tightly over splice.

Important:

Be very careful when soldering wires in your car. Cover nearby carpeting and seats to prevent damage from hot solder.

Professional Tip**Crimp Connections**

Purchase crimp connectors and crimping tool. Connectors are color coded. This Jensen radio uses RED connectors (18-20 gauge wire).

1. Strip 1/4 inch (6mm) of insulation from both wires.
2. Insert into connector.
3. Crimp tightly.

You can make permanent splices (using butt connectors) or select connectors that can be removed and reinstalled.

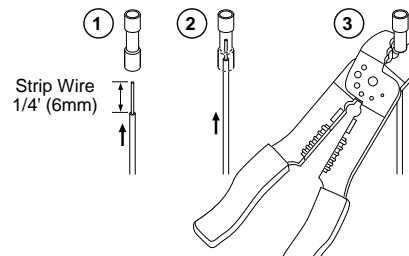
**Professional Tip****Upgrading Your System**

International Jensen makes a wide range of car stereo products that will make your car system sound better, great or INCREDIBLE!

Better Sound

Install a Jensen tape deck or CD player like you're doing now. High power units can make your existing speakers sound better and play louder.

Great Sound

Replace your existing speakers with Jensen speakers. Many of our speakers will fit into your car without cutting or drilling. You can also add an amplified graphic equalizer to tailor the sound to your liking.

INCREDIBLE Sound

Jensen offers a full line of amplifiers, high-power speakers and subwoofers that can turn your car into audio dynamite. You can go loud, louder and loudest by selecting Jensen components from your retailer.

Disconnect Battery

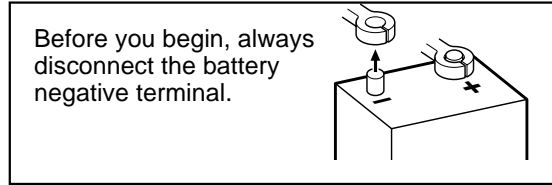

Remove Old Radio

Your original car radio is installed in one of four ways, depending on the car.

| | |
|---|---|
| <p>Bracket Mounted</p> <ol style="list-style-type: none"> 1. Remove dashboard faceplate 2. Unscrew brackets 3. Disconnect wiring harness and remove radio | <p>Removal Tool</p> <p>Some cars use a special removal tool to release the radio.</p> <ol style="list-style-type: none"> 1. Insert the tool(s) 2. Pull out the radio 3. Disconnect wiring harness and remove radio |
| <p>Replacing an Aftermarket Radio</p> <p>Use a screwdriver to bend tabs completely out of the way. Pull sleeve from dashboard. The sleeve should fit tightly and may be damaged unless you remove it carefully.</p> <ol style="list-style-type: none"> 1. Bend Tabs Flat 2. Pull Sleeve Out Caution: Edges are sharp. Use a rag or wear a glove. | <p>ISO-DIN</p> <ol style="list-style-type: none"> 1. Remove trim to expose DIN chassis. 2. Remove the ISO-DIN frame from the dashboard. 3. Unscrew screws from the sides. 4. Disconnect wiring harness and remove radio. |

Install Half-sleeve

Not needed for ISO-DIN (Japanese vehicle) installation.

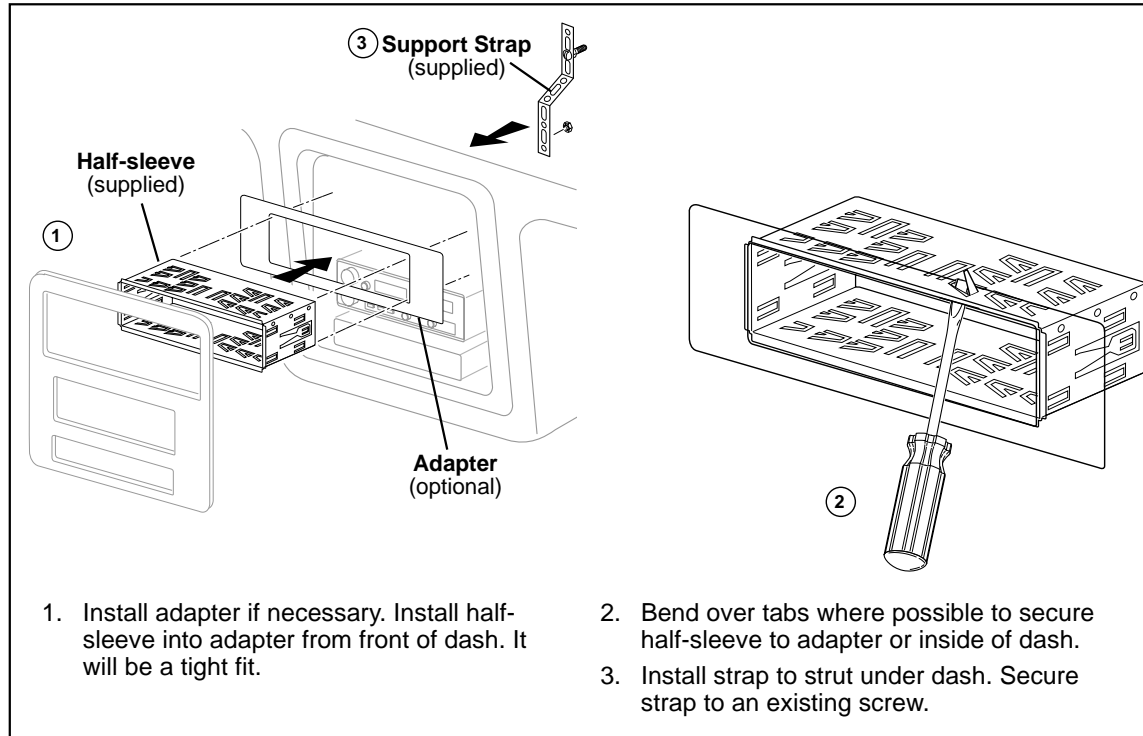

Wiring

Important

If wiring connections are made wrong, the unit will not operate properly and it could be damaged. Follow the installation instructions carefully, or have the installation handled by an experienced technician.

Professional Tip

Fuse Adapters

No convenient power wire? Install a fuse adapter having a spade connector.

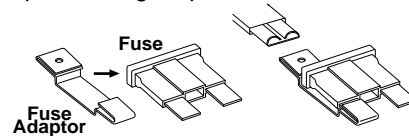

Crimp on a matching connector and attach:

- Yellow wire—Fuse marked MAIN, BAT or PWR
- Red wire—Fuse marked ACCY (accessory), or RADIO

Wiring with a Wiring Adapter

This is the easiest wiring method, because it replaces your existing radio. You will have to buy a wire harness adapter from your dealer, a car stereo installation shop or electronics store. If you use a wiring adapter, you can connect all wires to the radio before you even start to take your old radio out.

Connect Wires

Splice, crimp or solder the wires from the Jensen connector to the wiring adapter. Match the wires according to the chart (below) and the wiring adapter instructions.

Splices

You can make all these connections without even being in the car.

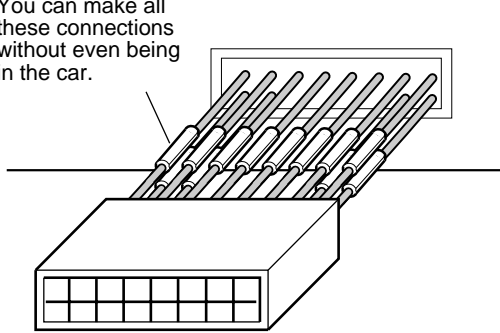

Wiring Adapter
(attach to car wiring harness)

Wiring Color Codes

| Function | Color |
|---------------|--------------|
| LF- Speaker | white/black |
| LF+ Speaker | white |
| LR- Speaker | green/black |
| LR+ Speaker | green |
| RF- Speaker | gray/black |
| RF+ Speaker | gray |
| RR- Speaker | violet/black |
| RR+ Speaker | violet |
| Power Antenna | dark blue |
| Ground | black |
| Ignition | red |
| Battery | yellow |

Install Wiring Inside the Car

1. Connect wiring adapter to the car's existing wiring harness.
2. Connect antenna extender cable to car antenna lead.
3. Slide radio part way into half-sleeve.

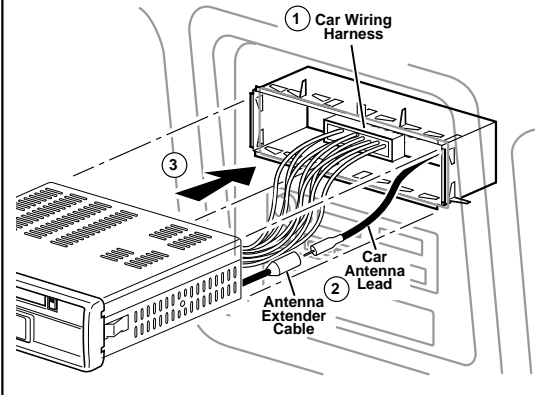

Go to **Testing** on page 8.

Wiring Diagram—Advanced Installation

If you are installing new speakers or amplifiers or replacing an aftermarket installation, use this diagram.

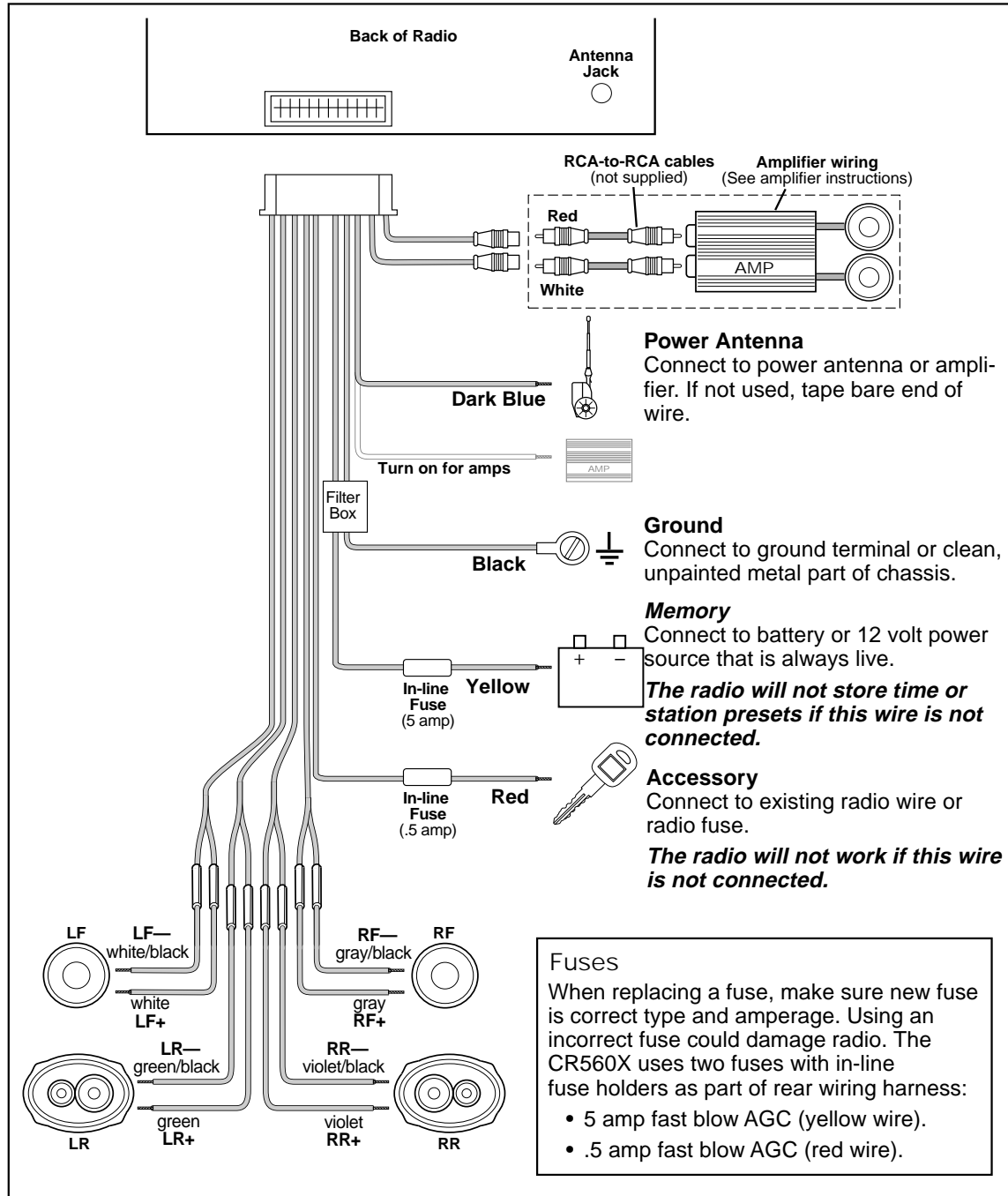

Go to **Testing** on page 8.

Testing

Before you finish the installation, you should do the following tests to make sure the wiring is correct and everything is operating properly.

Reconnect Battery

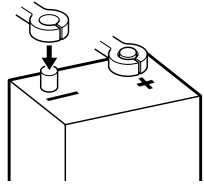

When wiring is complete, reconnect the battery negative terminal.





Test Power Wiring

1. Turn ignition switch on. Press the  (Power) button to turn the radio on. The display should light and show the radio display. If not, check the electrical connection at the yellow and red wires.
2. If equipped, the power antenna should also operate. If not, check electrical connections to the dark blue wire.

Test Antenna Connection

1. Hold a tuning button  or  for more than two seconds. The radio should tune to a nearby station. If not, check antenna connection.
2. Press  to increase volume until you can hear the radio playing.



Test Memory Wiring

1.  With the radio playing, hold button 1 for two seconds. CH 1 will appear on the display. You just stored the current station in memory.
2.  Turn the key off, then turn the key on again.
3. The radio should resume playing at the same station and volume. If not, make sure the yellow wire is connected properly.

Set the Clock

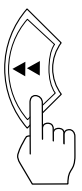
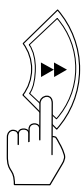











Press **DISP** button to display the clock.

1.  Press **DISP** button for three seconds until display flashes.
2.  Press **◀** to change minutes,  to change hours.

Test Speaker Connections

These tests make sure the speakers are connected right. If speakers don't play at all, both wires may not be connected. If the wrong speaker plays (you hear front speakers when you expect rear speakers) make sure you connected the wires right.

|  | Balance |  | Fader |
|---|--|---|--|
| <p>1 </p> <p>2 </p> <p></p> | <p>1. Press SEL four times.</p> <p>2. Hold the + button until the display shows BA.r 10.</p> <p>Only the right speakers should be playing. If not, check the wiring. Make sure you connected the wires just like the chart on page 6.</p> | <p>5 </p> <p>6 </p> <p></p> | <p>5. Press SEL five times.</p> <p>6. Hold the + button until the display shows FA.F 10.</p> <p>Only the front speakers should be playing. If not, check the wiring. Make sure you connected the wires just like the chart on page 6.</p> |
| <p>3 </p> <p>4 </p> <p></p> | <p>3. Press SEL four times again.</p> <p>4. Hold the - button until the display shows BA.L 10.</p> <p>Only the left speakers should be playing. If not, check the wiring. Make sure you connected the wires just like the chart on page 6.</p> | <p>7 </p> <p>8 </p> <p></p> | <p>7. Press SEL five times again.</p> <p>8. Hold the - button until the display shows FA.r 10.</p> <p>Only the rear speakers should be playing. If not, check the wiring. Make sure you connected the wires just like the chart on page 6.</p> |

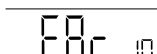
Once everything is operating correctly, perform **Final Installation** on page 10.

Final Installation

1. Slide radio chassis into half-sleeve
2. Secure to strap using nut
3. Install faceplate by fitting left edge into position then pushing right edge closed.
4. Reinstall any items you removed from the dashboard.

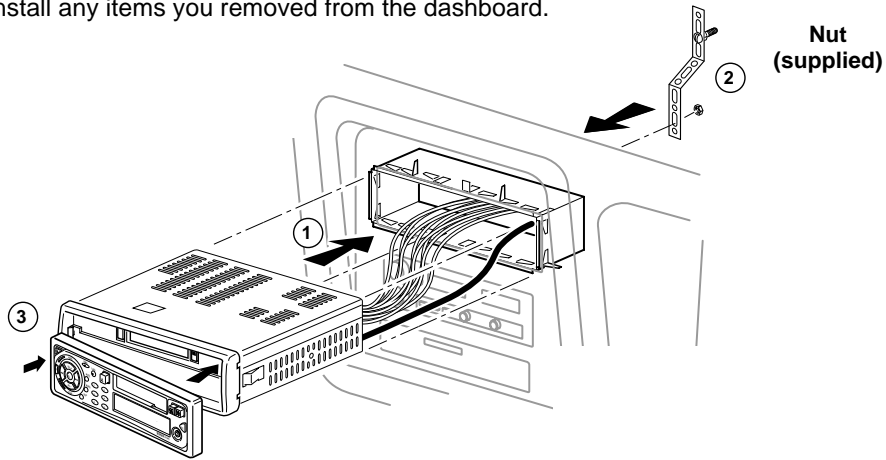

Final Installation-ISO-DIN

1. Remove trim ring from front of radio. Trim ring is not needed for this type of installation.
2. Mount factory brackets on new radio using existing screws from old radio.
3. Slide radio and frame into dash opening and secure.
4. Install dash panels previously removed.
5. Install faceplate by fitting left edge into position then pushing right edge closed.

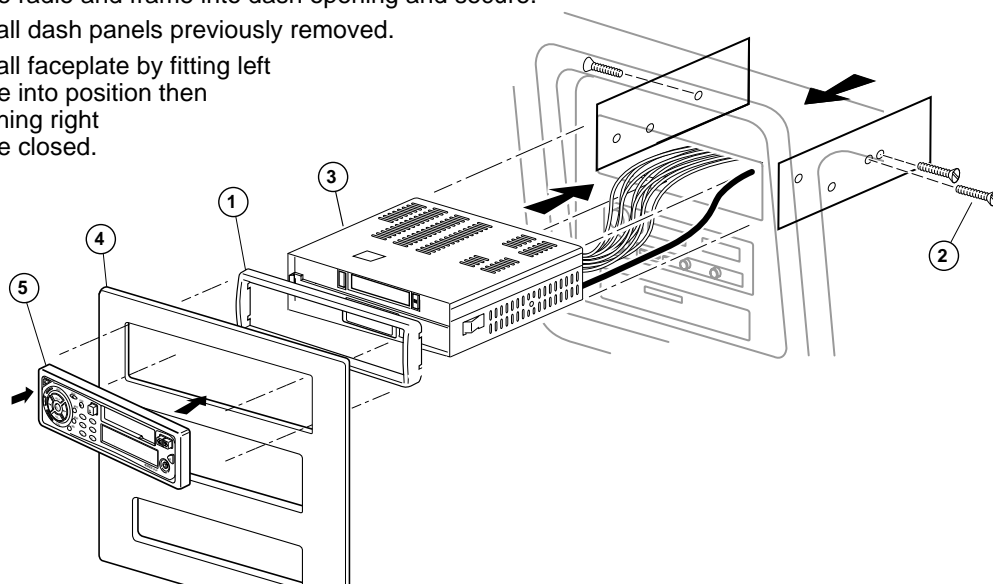

Troubleshooting

| Problem | Cause | Corrective Action |
|---|---|---|
| Does not operate (radio does not light) | No power to red wire (12V with key on) | Check connection Check vehicle fuse |
| | Inline fuse blown | Replace fuse |
| No speakers operate (radio lights normally) | Speaker wires not connected | Connect speaker wires |
| Not all speakers operate | Incorrect splices or connections | Check all splices and connections |
| | Speaker wires shorting to chassis ground or to each other | Check splices, insulate all bare wires |
| Blows fuses | Power wire shorting to ground | Insulate wire |
| | Speaker wires shorting to ground | Insulate wire |
| | Incorrect fuse | Install fuse of correct rating |
| Can't find cause of problem | | Call Jensen Technical Assistance (1-800-323-0221) |

Removing Radio from Dash

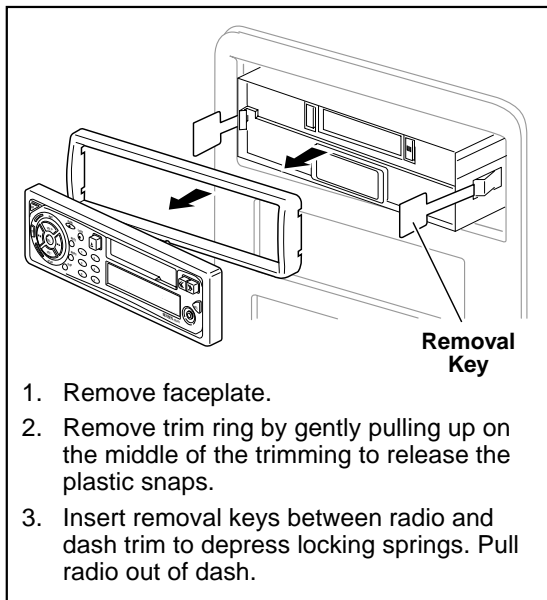

Professional Tip

Securing Wires

Be proud of your installation! Use wire ties to bundle wires together when possible. (But never bundle speaker wires and power wires together!)

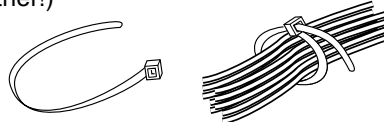

Secure loose wires to the car to make sure they don't rub or rattle.



Specifications

FM Tuner

| | |
|---|--------------------|
| Tuning range | 87.5 MHz-107.9 MHz |
| FM mono sensitivity | 12 dBf |
| 50 dB quieting sensitivity (stereo) | 16 dBf |
| Stereo separation @ 1 kHz | 40 dB |

AM Tuner

| | |
|--------------------------|--|
| Tuning range | 530 kHz-1710 kHz |
| Amplifier | |
| Total system power | 100 Watts peak |
| Power output | front: 2 x 25 Watts rear: 2 x 25 Watt |

Tape

| | |
|--|-------------|
| Frequency response | 50 Hz-14KHz |
| Wow & flutter | .15% JIS |
| Channel separation | 35db@1 KHz |
| Signal to noise ratio (a-weighted) | 55db |

General

| | |
|--------------------------------|----------------------------------|
| Power supply | 11-16 VDC, negative ground |
| Speaker output impedance | 4-8 Ohms |
| Fuses | fast blow AGC (.5 amp and 5 amp) |

Specifications subject to change without notice.

Limited One Year Warranty-USA and Canada

Length of Warranty. This warranty from Recoton Mobile Electronics shall be in effect for a period of one year from the date of the first consumer purchase.

Persons Protected. This warranty will be enforceable by the original owner and any subsequent owners during the warranty period so long as proof of date of purchase from an authorized Jensen dealer is presented whenever warranty service is required.

What is Covered. Except as otherwise specified below, this warranty covers all defects in material and workmanship in this product. The following are not covered: damage resulting from accident, misuse, abuse, neglect, product modification, improper installation, incorrect line voltage, unauthorized repair or failure to follow instructions supplied with the product; damage occurring during shipment (claims must be presented to the carrier); elimination of car static or other electrical interferences; any product purchased outside USA or Canada, or on which the serial number has been defaced, modified or removed.

How You Can Get Service.

U.S. Purchasers. Please telephone Jensen at 1-800-323-4815. We will either inform you of the name and address of an authorized Jensen repair station which will service the product or will advise you to send the product to a factory service center.

Canadian Purchasers. The product should be returned to the Jensen dealer from whom it was purchased and such dealer either will service or arrange for service of the product.

If shipment of the product is required, it should be packed securely. The original dated bill of sale must always be included with the product as proof of warranty coverage.

What We Will Pay For. We will pay for all labor and material expenses required to repair the product, but you must pay any labor costs for the removal and/or installation of the product. If the product is shipped for warranty service, you must prepay the initial shipping charges, but Jensen will pay the return shipping charges if the product is returned to an address inside the USA or Canada.

Limitation of Implied or Statutory Warranties and Conditions. All implied or statutory warranties and conditions, including warranties or conditions of merchantability, fitness for particular purposes and non-infringement, are limited in duration to the length of this warranty.

Exclusion of Certain Damages. Jensen's liability is limited to the repair or replacement, at our option, of any defective product and shall not include incidental or consequential economic damages of any kind.

Some states and/or provinces do not allow limitations on how long an implied warranty lasts and/or do not allow the exclusion or limitation of incidental or consequential damages, so the above limitations and exclusions may not apply to you.

This warranty gives you specific legal rights, and you may also have other rights which vary from state to state and province to province.

JENSEN®

Recoton Mobile Electronics
A Division of Recoton Audio Corporation
A RECOTON® COMPANY
1090 Emma Oaks Trail
Lake Mary, Florida 32746

©2000 Recoton Audio Corporation

Free Manuals Download Website

<http://myh66.com>

<http://usermanuals.us>

<http://www.somanuals.com>

<http://www.4manuals.cc>

<http://www.manual-lib.com>

<http://www.404manual.com>

<http://www.luxmanual.com>

<http://aubethermostatmanual.com>

Golf course search by state

<http://golfingnear.com>

Email search by domain

<http://emailbydomain.com>

Auto manuals search

<http://auto.somanuals.com>

TV manuals search

<http://tv.somanuals.com>