

# PA500 Owner's/Installation Manual

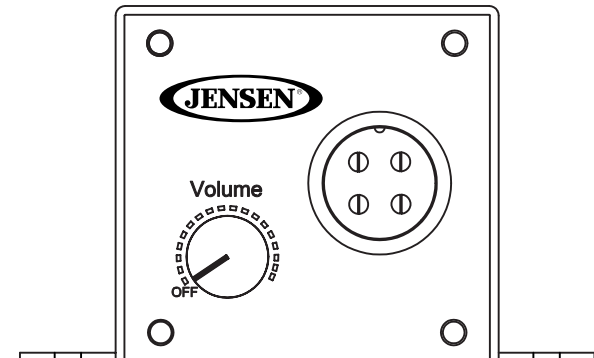

Universal Public Address System

ASA ELECTRONICS  
2602 Marina Drive  
Elkhart, IN 46514  
1-800-688-3135  
[www.asaelectronics.com](http://www.asaelectronics.com)

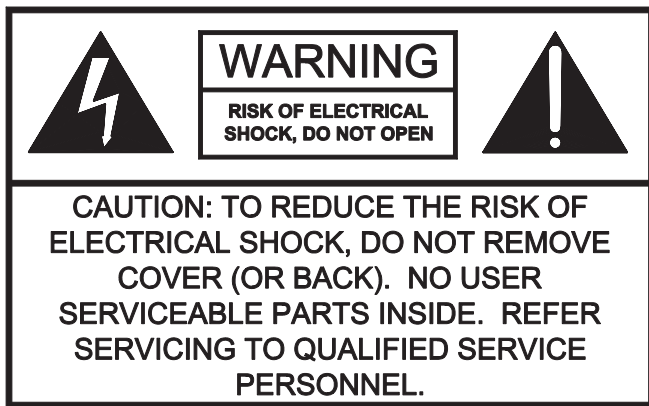

The lightning flash with the arrowhead symbol, within an equilateral triangle, is intended to alert the user to the presence of uninsulated "dangerous voltage" within the product's enclosure that may be of sufficient magnitude to constitute a electric shock to persons.



The exclamation point within an equilateral triangle is intended to alert the user to the presence of important operating and maintenance (servicing) instructions in the literature accompanying the appliance.

## Description:

The JENSEN PA500 is a universal public address system that can be utilized as a stand alone PA (when connected to speakers) or operate in conjunction with any existing radio/speaker set up.

## Operation:

The PA500 system amplifier connects in line between the vehicle's radio and the installed speakers. The installed radio will operate normally. When the microphone is activated by the "Push to Talk" (PTT) switch on the microphone, the speakers are electrically disconnected from the radio and engaged with the PA. The microphone triggers activation of the PA through the same speakers (muting/overriding the radio source). There is no need to adjust PA volume at the radio since the PA volume can be set using the volume/gain control on the PA500 itself. If the PA500 is installed in an enclosure the volume level can be pre-set by the installer.



# Panel Cutout (Optional Installation):

The PA500 may also be mounted through a panel (as shown below). In this method, the microphone volume may be adjusted or turned on/off to meet the operator's preference.

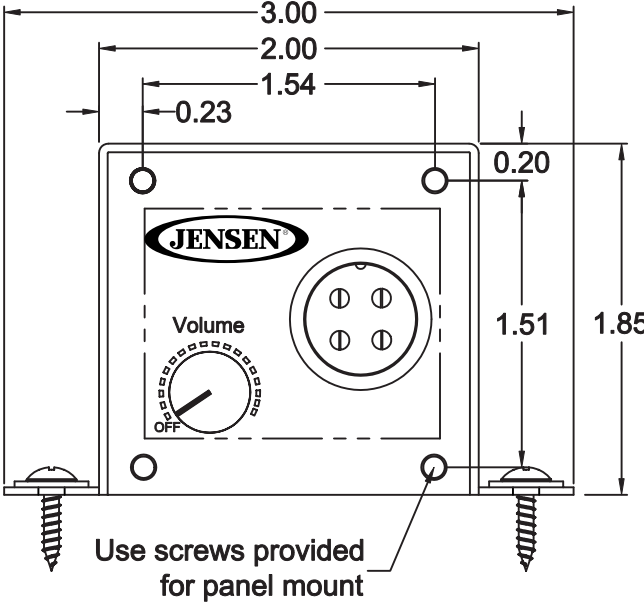
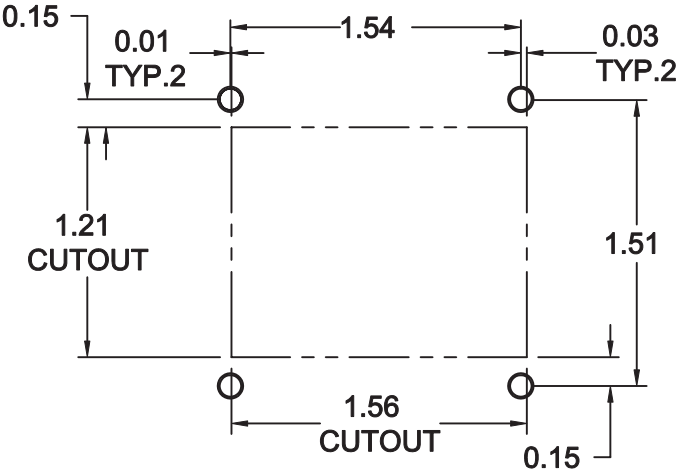

# Troubleshooting:

Symptom	Possible Cause	Possible Solution
Has audio from radio but not PA500	<ul style="list-style-type: none"> <li>- PA not turned on</li> <li>- Volume set too low on PA</li> <li>- In-line fuse blown</li> <li>- Input and output wired backwards</li> </ul>	<ul style="list-style-type: none"> <li>- Turn PA on</li> <li>- Adjust volume of PA to higher level</li> <li>- Check and replace in-line fuse</li> <li>- Reverse input and output wiring</li> </ul>
High pitched squeal (feed back)	<ul style="list-style-type: none"> <li>- Volume on PA set too high</li> </ul>	<ul style="list-style-type: none"> <li>- Turn volume on PA down</li> </ul>
Hand held MIC keyed and gets feed back	<ul style="list-style-type: none"> <li>- Volume on PA set too high</li> <li>- Volume on MIC set too high</li> </ul>	<ul style="list-style-type: none"> <li>- Turn volume on PA down</li> <li>- Turn volume down on MIC</li> </ul>
PA500 will not turn on, (does not have power)	<ul style="list-style-type: none"> <li>- In-line fuse on PA blown</li> </ul>	<ul style="list-style-type: none"> <li>- Replace fuse</li> </ul>

# Specifications:

- 4 Channels
  - Current Draw
  - Frequency Response
  - Size
  - Weight
- 25 Watts per channel, 4 ohm load
  - 7 Amp Max.
  - 100-10,000
  - 3.08" x 1.85" x 4.0" (W x H x D)
  - 15 oz.

## Speaker Connections:

### 3 Pair- 4Ohm Speakers

Curb Side  
6 Ohm  
Total Impedance

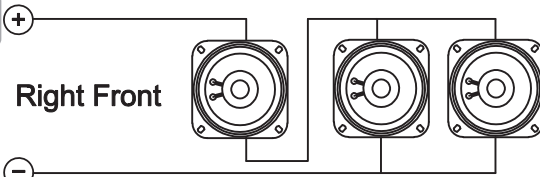

Driver Side  
6 Ohm  
Total Impedance

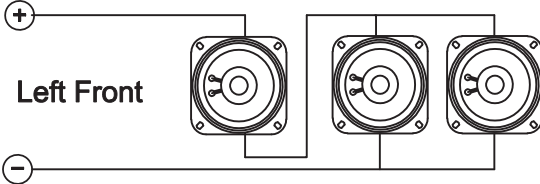

Align Speakers with "+" on top and "-" on bottom as shown

### 4 Pair- 4Ohm Speakers

Curb Side  
4 Ohm  
Total Impedance

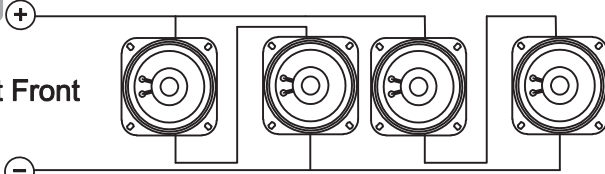

Driver Side  
4 Ohm  
Total Impedance

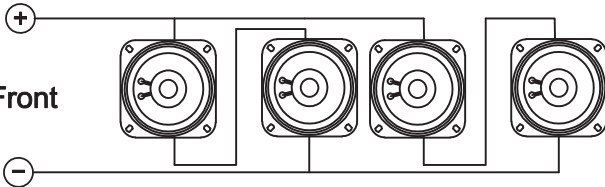

Align Speakers with "+" on top and "-" on bottom

### 5 Pair- 4Ohm Speakers

Curb Side  
4.8 Ohm  
Total Impedance

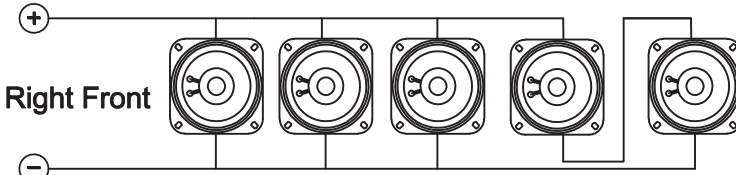

Driver Side  
4.8 Ohm  
Total Impedance

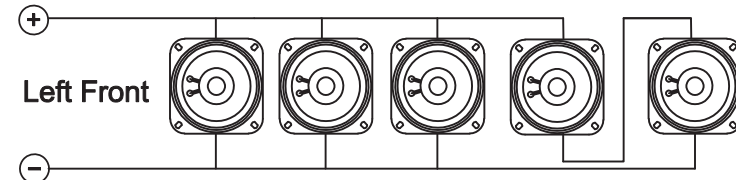

Align Speakers with "+" on top and "-" on bottom

## Optional Flange Mount Installation:

The PA500 may also be mounted in a "blind" location, using the mounting holes on the flanges. In this case, the microphone volume must be pre-set by the installer prior to the completion of the installation. The 30 ft. microphone extension/adaptor cable (P/N 1401035) or the 36" microphone extension/adaptor cable (P/N 1401040), is to be used to allow connection of a PTT (Push To Talk) type microphone by the operator.

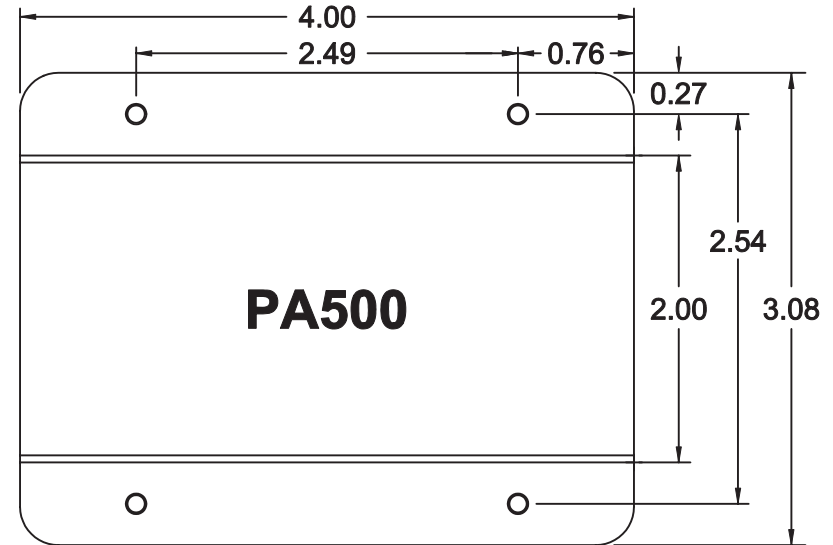

# Typical Wiring Connections:

## INPUT NOTES:

Wire Radio according to Manufacturer Spec.

PA500 can accept any radio (up to 4 Channels).

Maintain appropriate load requirements.  
(4 ohm minimum suggested)

## Radio to PA500

RA RF +	Gray
RA RF -	Gray/Black
RA LF +	White
RA LF -	White/Black
RA RR +	Violet
RA RR -	Violet/Black
RA LR +	Green
RA LR -	Green/Black

# PA500 Applications con't.:

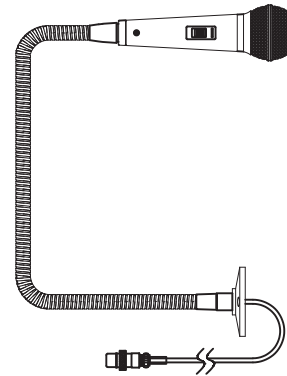

Boom Microphone  
P/N JMICBOM

## Optional Examples:

### INPUT 4 Wire

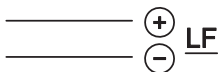
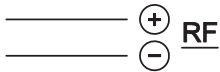

### OUTPUT 2 Speaker

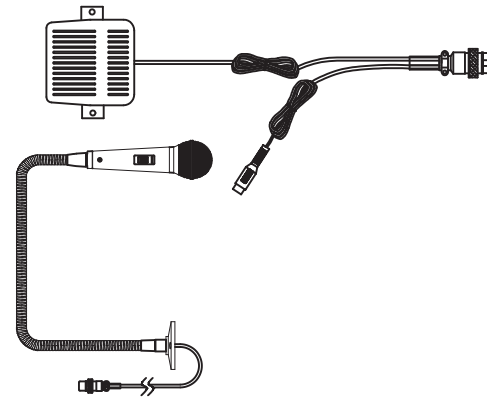
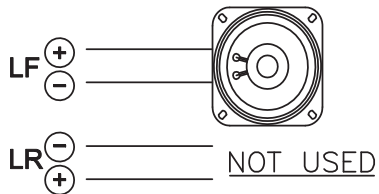
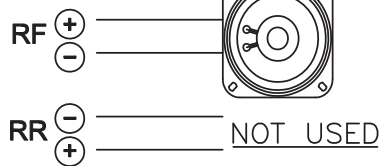

Boom Microphone with  
Foot Pedal  
P/N JMICBOMFP

※ The PA500 is also compatible with older VOYAGER and JENSEN Microphones such as the BVMH01 and BVMH01M

# JENSEN PA500 Applications

The JENSEN PA500 is compatible with the following JENSEN microphones:

Part Number	Description
JMICHND	Hand held Microphone
JMICBOM	Boom Microphone
JMICHST	Hostess Microphone
JMICBOMFP	Boom Microphone with foot pedal

In applications which require remote mounting of the PA500, JENSEN offers both a 3ft (#1401020) and a 20 ft (#1401003) extension/adapter cable

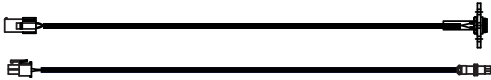

20 Ft Extension Cable  
P/N 1401003



3 Ft Extension Cable  
P/N 1401020

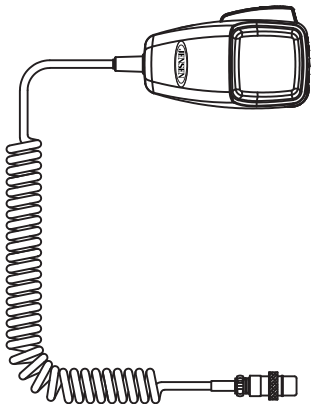

Hand Held Microphone  
P/N JMICHND

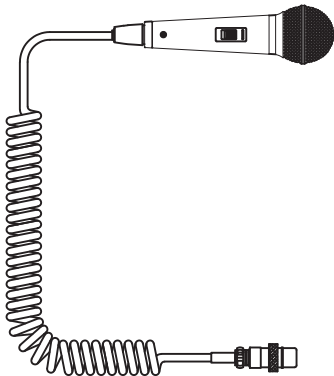

Hostess Microphone  
P/N JMICHST

## To PA500 Speakers

SP RF +
SP RF -
SP LF +
SP LF -
SP RR +
SP RR -
SP LR +
SP LR -

## OUTPUT NOTES:

Do not ground any leads.

Do not tie output leads together.

It is permissible to use only Front or Rear Inputs and Outputs in 2 speaker /4 Wire Systems

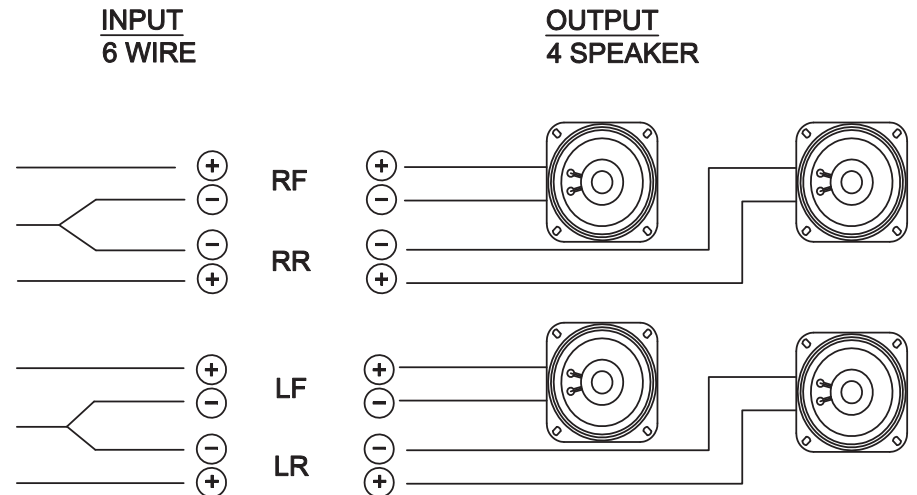

# PA500 Wiring:

## Wiring Chart for Radio and Speaker Connections

Wire Color	Speaker Connection
Gray	Right Front +
Gray/Black	Right Front -
White	Left Front +
White/Black	Left Front -
Violet	Right Rear +
Violet/Black	Right Rear -
Green	Left Rear +
Green/Black	Left Rear -

## Hardware Kit:

Quantity- Type  
4- M5 x 13mm Philips PH Tapping Screw

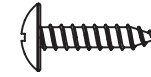

4- M3.5 Flat Washer

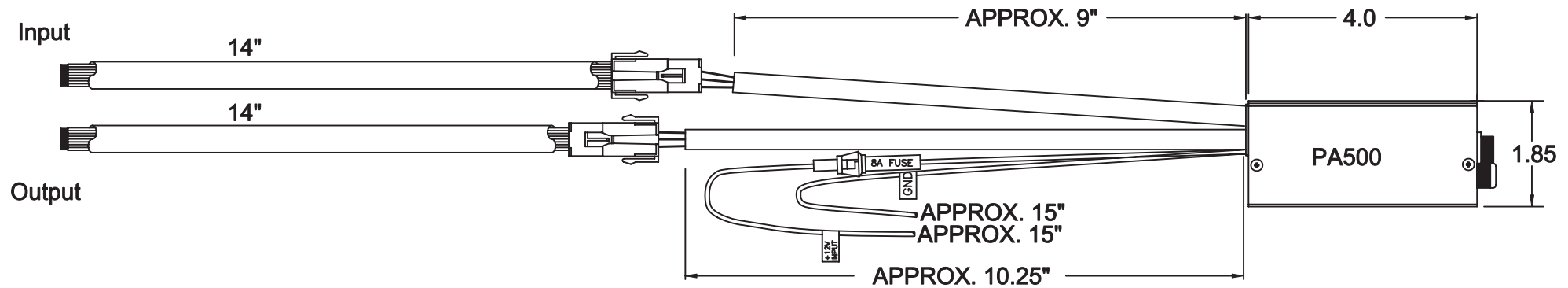



## Free Manuals Download Website

<http://myh66.com>

<http://usermanuals.us>

<http://www.somanuals.com>

<http://www.4manuals.cc>

<http://www.manual-lib.com>

<http://www.404manual.com>

<http://www.luxmanual.com>

<http://aubethermostatmanual.com>

Golf course search by state

<http://golfingnear.com>

Email search by domain

<http://emailbydomain.com>

Auto manuals search

<http://auto.somanuals.com>

TV manuals search

<http://tv.somanuals.com>