



DESIGNED TO MOVE [YOU]

DVDB01

DVD/CD/MP3 Player

Installation and Operation Manual

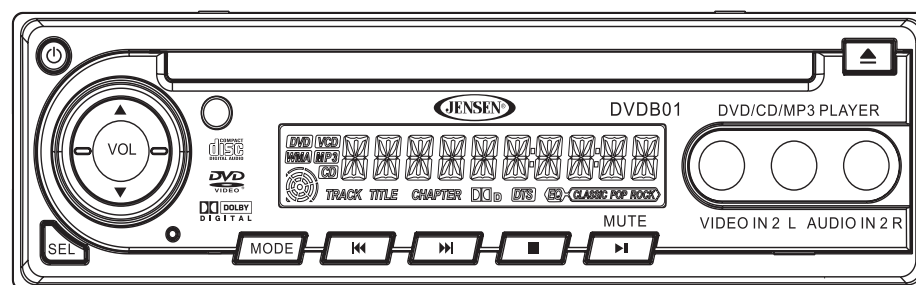

INTRODUCTION

Thank you for choosing a JENSEN product. We've tried to make the instructions in this owner's manual clear and easy to follow. If you take a few minutes to look through it, you'll learn how to use all of the features of your new JENSEN DVDB01 Mobile Multimedia DVD/CD/MP3 Player for maximum enjoyment.

Contents

Introduction.....	3
Preparation.....	4
Installation.....	5
Wiring.....	7
Controls and Indicators.....	9
Basic Operation.....	11
CD/DVD/VCD Operation.....	12
MP3 Operation.....	15
DVD Setup Menu.....	17
Disc Symbols and Properties.....	19
Troubleshooting.....	20
Specifications.....	21
Warranty.....	21

Features

- High temperature deck and OPU
- Slot type drive
- Front and rear AV jacks for system expansion
- Din size with mounting brackets included
- LCD display with amber back lighting
- Amber back lit buttons
- Dolby digital sound
- IR remote control included
- 12 volt operation
- Compatible with PAL and NTSC DVD (Video CD)
- L/R stereo analog audio outputs for connection to existing head unit aux inputs
- Composite video output

Precautions

- **Use the Proper Power Supply.**
This product is designed to operate with a 12 volt DC, negative ground battery system (the regular system in a North American car).
- **Protect the Disc Mechanism.**
Avoid inserting any foreign objects into the slot of this player. Failure to observe this may cause malfunction due to the precise mechanism of this unit.
- **Use Authorized Service Centers.**
Do not attempt to disassemble or adjust this precision product; contact a professional for assistance.

- **Avoid Moisture.**
To reduce the risk of fire or electric shock, do not expose this equipment to rain or moisture.
- **Use Recommended Accessories:**
TO REDUCE THE RISK OF FIRE OR ELECTRIC SHOCK AND ANNOYING INTERFERENCE, USE ONLY THE RECOMMENDED ACCESSORIES.

CAUTION: *This mobile DVD player is a Class I laser product that uses a visible/invisible laser beam which could cause hazardous radiation exposure if improperly directed. Be sure to operate the mobile DVD player as instructed. Use of controls or adjustments or performance of procedures other than those specified herein may result in hazardous radiation exposure. Do not open covers and do not attempt to repair the unit yourself. Refer servicing to qualified personnel.*

PREPARATION

It's a good idea to read all of the instructions before beginning the installation. We recommend having your JENSEN DVDB01 installed by a reputable installation shop.

Tools and Supplies

You will need these tools and supplies to install your DVDB01:

- Torx type, flat-head and Philips screwdrivers
- Wire cutters and strippers
- Tools to remove existing radio (screwdriver, socket wrench set or other tools)
- Electrical tape
- Crimping tool
- Volt meter/test light
- Crimp connections
- 18 gauge wire for power connections
- 16 – 18 gauge speaker wire

Disconnecting the Battery

To prevent a short circuit, be sure to turn off the ignition and remove the negative (-) battery cable prior to installation.

NOTE: If the DVDB01 is to be installed in a vehicle equipped with an on-board drive or navigation computer, do not disconnect the battery cable. If the cable is disconnected, the computer memory may be lost. Under these conditions, use extra caution during installation to avoid causing a short circuit.

INSTALLATION

DIN Front-Mount Installation

1. Use the supplied release keys to remove the half-sleeve from the unit.

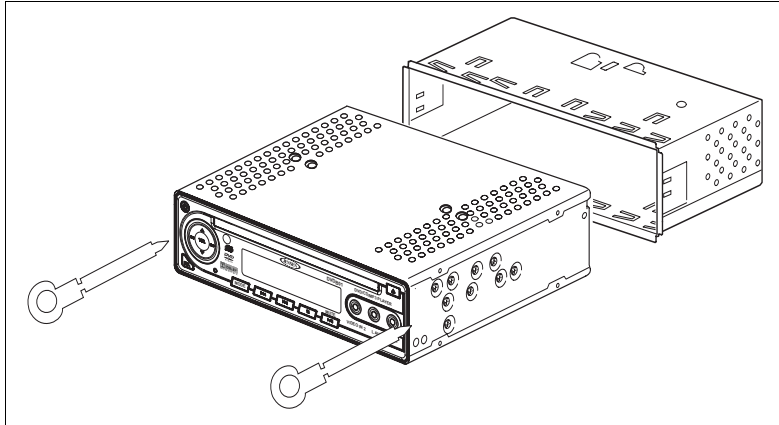

2. Install the half-sleeve.
 - a. Install adapter if necessary (optional).
 - b. Install half-sleeve into adapter or dashboard using the supplied screws. Do not force the sleeve into the opening or cause it to bend or bow.
 - c. Locate the series of bend tabs along the top, bottom and sides of the mounting sleeve. With the sleeve fully inserted into the dashboard opening, bend as many of the tabs outward as necessary to firmly secure the sleeve to the dashboard.

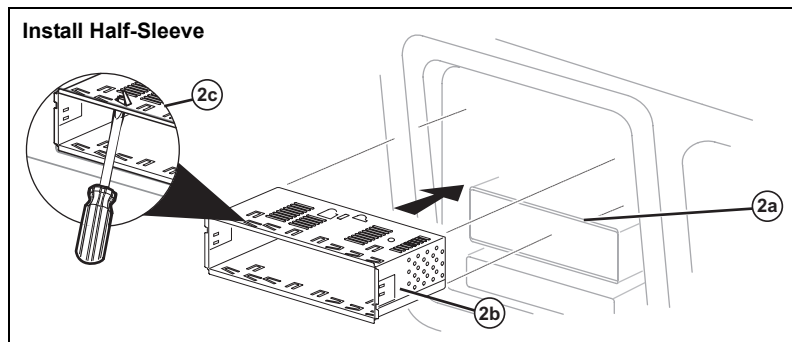

CAUTION! Be careful not to damage the vehicle's wiring.

3. Place the unit in front of the dashboard opening so the wiring can be brought through the mounting sleeve.
4. Complete wiring connections (see "Wiring" on page 7).
5. After completing the wiring connections, turn the unit on to confirm operation (ignition switch must be on). If unit does not operate, recheck all wiring until problem is corrected. Once the unit is properly operating, turn off the ignition switch and proceed with final mounting of the chassis.
6. Carefully slide the DVD player into the half-sleeve making sure it is right-side-up until it is fully seated and the spring clips lock it into place.

NOTE: For proper operation of the CD/DVD player, the chassis must be mounted within 30° of horizontal. Make sure the unit is mounted within this limitation.

7. Attach one end of the perforated support strap (supplied) to the screw stud on the rear of the chassis using the hex nut provided. Fasten the other end of the perforated strap to a secure part of the dashboard either above or below the unit using the screw and hex nut provided. Bend the strap to position it as necessary.

CAUTION! The rear of the unit must be supported with the strap to prevent damage to the dashboard from the weight of the unit or improper operation due to vibration.

8. Replace any items you removed from the dashboard.

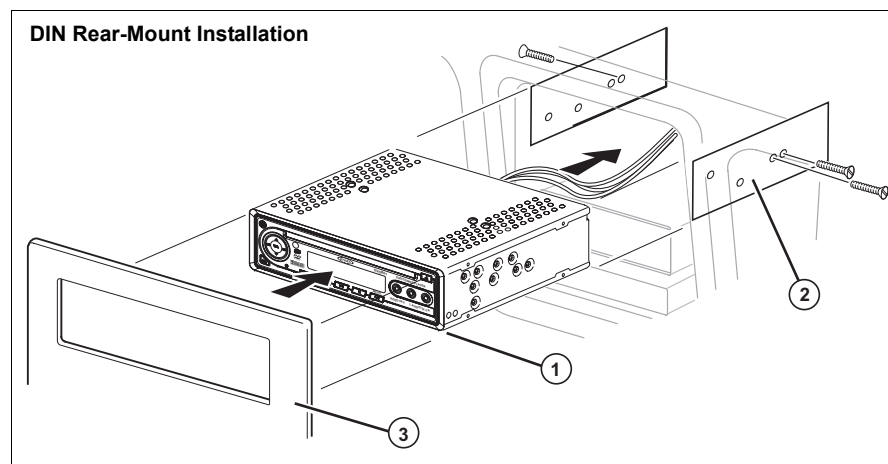
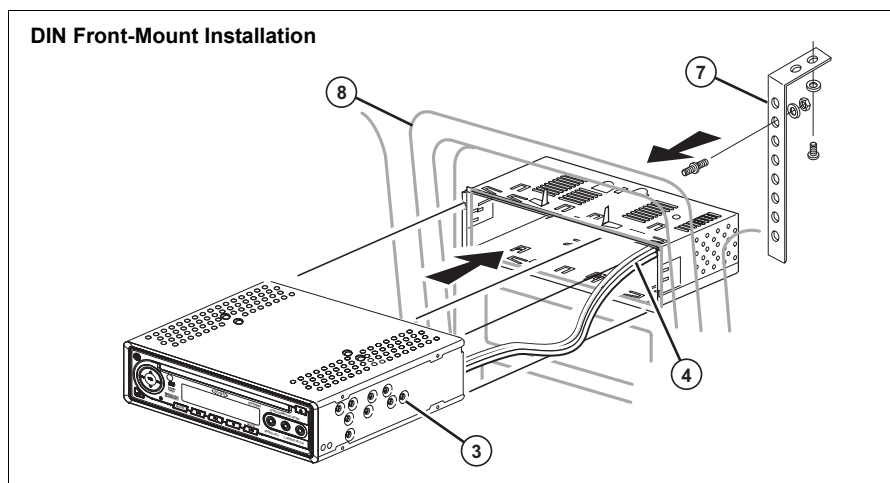

DIN Rear-Mount Installation

With some vehicles, you can use the screw holes located on both sides of the unit to fasten the unit to the factory radio mounting brackets supplied with your vehicle. To install this unit using factory mounting plates, perform the following steps:

1. Remove trim ring.

NOTE: The outer trim ring, sleeve and the metal strap are not used for DIN rear-mount installation.

2. Align the screw holes on the bracket with the screw holes on the unit, then tighten the screws (5x5mm) on each side.
3. Reinstall the dash panel.

Reconnecting the Battery

When wiring is complete, reconnect the battery negative terminal.

Removing the Unit

1. Make sure the ignition is turned off, then disconnect the cable from the vehicle battery's negative (-) terminal.
2. Remove the metal strap attached the back of the unit (if attached).
3. Lift the top of the outer trim ring then pull it out to remove it.
4. Insert both of the supplied keys into the slots at the middle left and right sides of the unit, then pull the unit out of the dashboard.

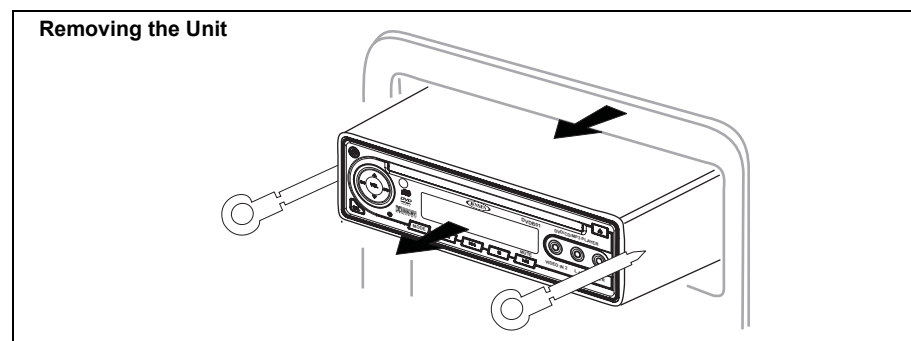

WIRING

Power/Accessory Connections

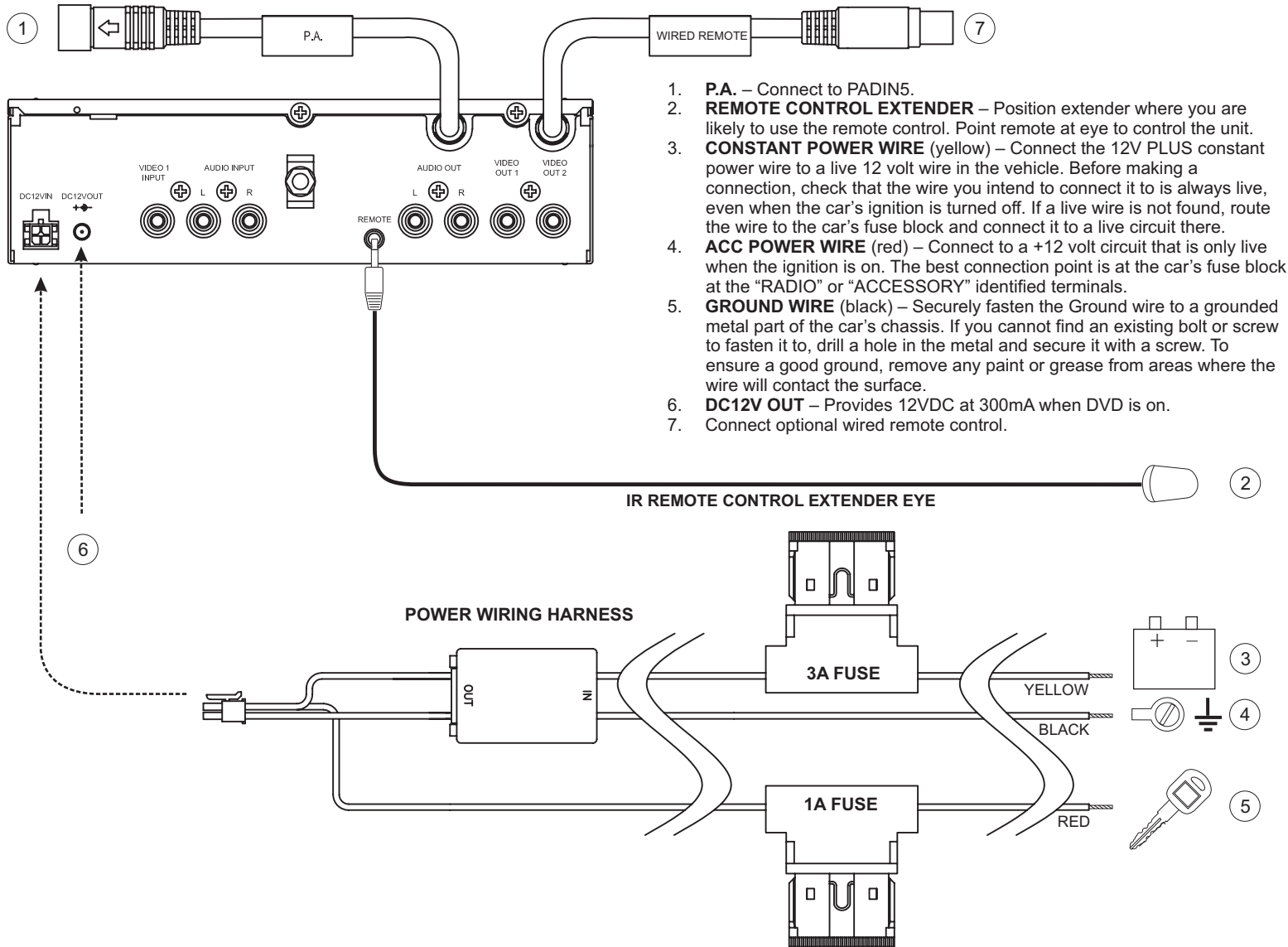

1. **P.A.** – Connect to PADIN5.
2. **REMOTE CONTROL EXTENDER** – Position extender where you are likely to use the remote control. Point remote at eye to control the unit.
3. **CONSTANT POWER WIRE** (yellow) – Connect the 12V PLUS constant power wire to a live 12 volt wire in the vehicle. Before making a connection, check that the wire you intend to connect it to is always live, even when the car's ignition is turned off. If a live wire is not found, route the wire to the car's fuse block and connect it to a live circuit there.
4. **ACC POWER WIRE** (red) – Connect to a +12 volt circuit that is only live when the ignition is on. The best connection point is at the car's fuse block at the "RADIO" or "ACCESSORY" identified terminals.
5. **GROUND WIRE** (black) – Securely fasten the Ground wire to a grounded metal part of the car's chassis. If you cannot find an existing bolt or screw to fasten it to, drill a hole in the metal and secure it with a screw. To ensure a good ground, remove any paint or grease from areas where the wire will contact the surface.
6. **DC12V OUT** – Provides 12VDC at 300mA when DVD is on.
7. Connect optional wired remote control.

Audio/Video Connections

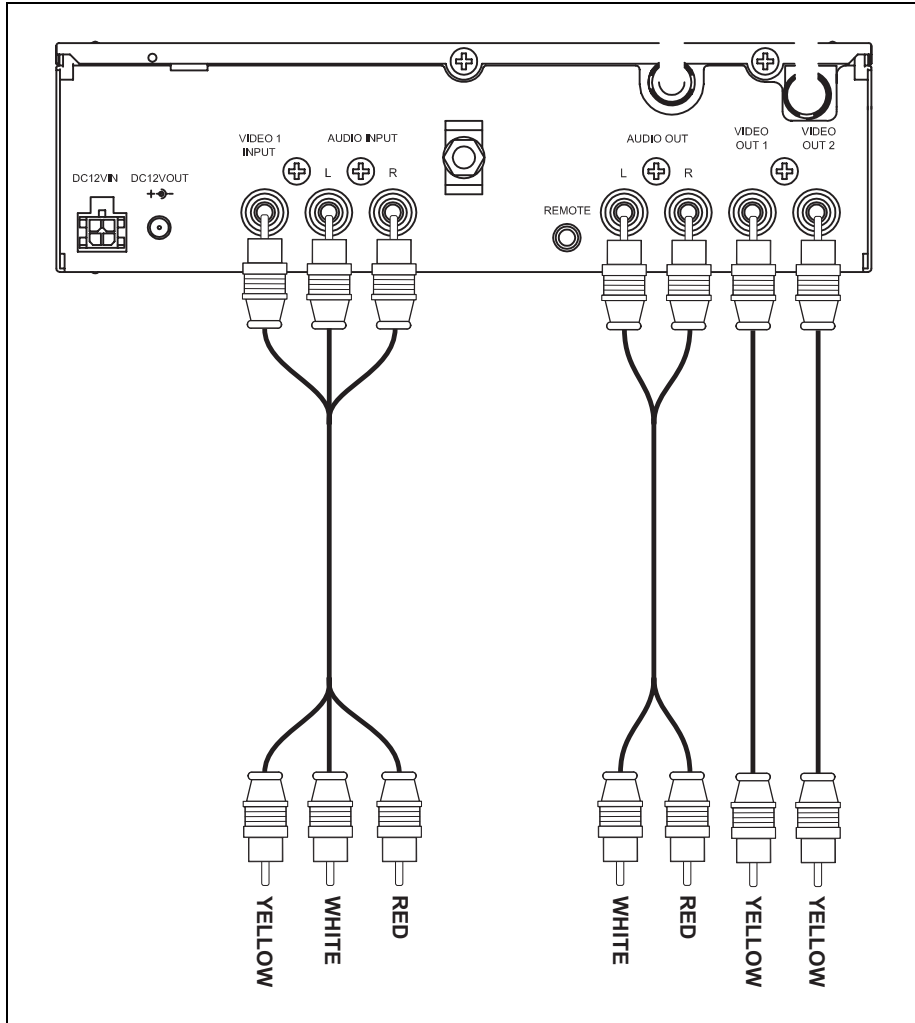

NOTE: When replacing a fuse, be sure to use correct type and amperage to avoid damaging the DVD player. The DVDB01 uses one 3 amp and one 1 amp ACC fuse, located in line with the power wires.

CONTROLS AND INDICATORS

The buttons located on the unit and the remote control that perform the same function are assigned the same number for reference on the diagrams and in the text.

Front Panel Operation

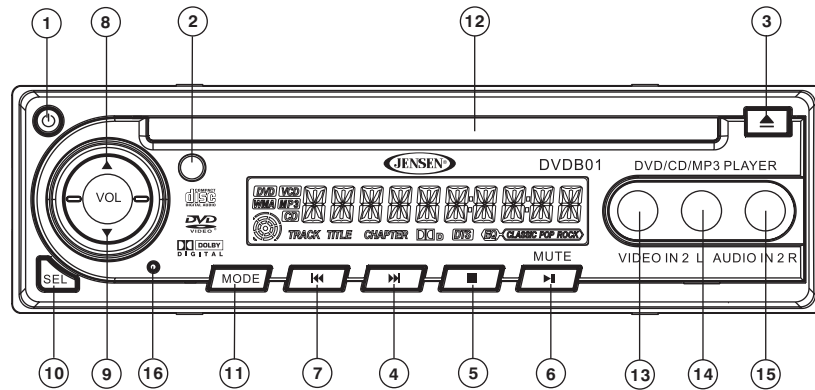

1. Power
2. Infrared Sensor
3. Eject
4. Fast Forward/Advance Chapter
5. Stop
6. Pause/Play/Mute
7. Rewind/Previous Chapter
8. Volume Up
9. Volume Down
10. Select
11. Mode
12. Disc Slot
13. Video In
14. Left Audio In
15. Right Audio In
16. Reset



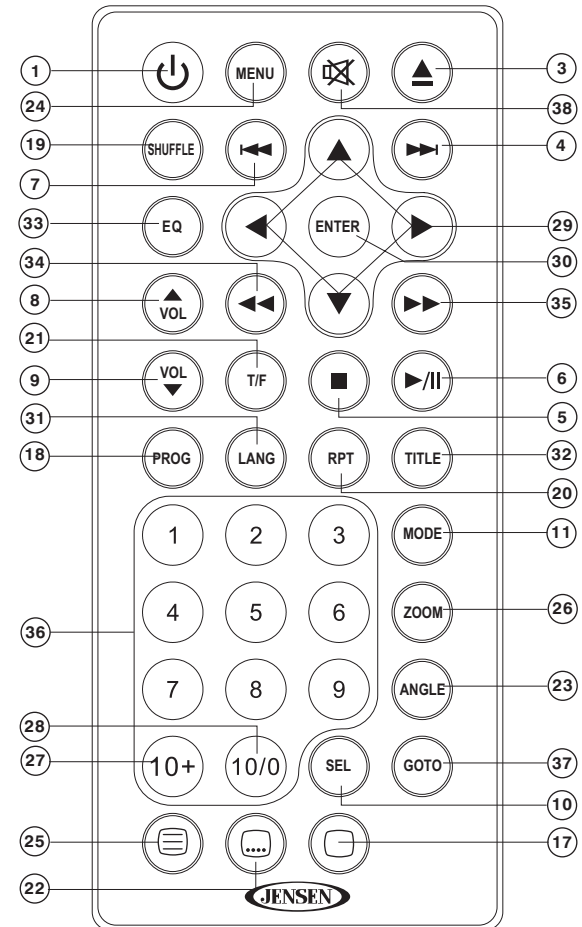



Remote Control Operation



Using the Remote Control

Point the remote control towards the player front face remote sensor IR (2). The operation angle is approximately 30 degrees in each direction of the front of the remote sensor.

Remote Control Functions

Ref #	Button	Function
1	 /POWER	Turn the unit ON or OFF
3	 /EJECT	Eject the disc
4	>>/TRACK	Skip to the next track/chapter
5		Stop disc playback
6	>	Play/pause the disc (for disc play mode)
7	<</TRACK	Go to previous track/chapter
8	VOL \wedge	Increase the volume level
9	VOL \vee	Decrease the volume level
10	SEL	Select the desired adjustment mode. Press VOL+/- to change settings.
11	MODE	Change between disc (DVD/VCD/CD/MP3) play mode and AV IN1 or AV IN2 mode
17		Display statistical disc information during playback
18	PROG	Display programmed playback screen, allowing you to enter tracks to play in programmed order.
19	SHUFFLE	Play tracks in random order (NOT for DVD)
20	RPT	Repeat current track/chapter
21	T/F	<i>Press and hold</i> to set clock. Use track down to adjust hours and track up to adjust minutes.
22		Change the SUBTITLE language on multi-subtitle language DVD discs
23	ANGLE	Change the viewing angle on multi-angle DVD discs
24	MENU (PBC)	Display the root menu stored on DVD discs/Switch between PBC ON and PBC OFF on VCD discs
25		Display the SETUP menu
26	ZOOM	Increase the picture size
27	10+	Use to select a digit for the tens position when performing track/file search.
28	10/0	
29	<, > \wedge , \vee	Select items left/right and ahead/back in menu mode
30	ENTER	Confirm selection of track/chapter
31	LANG	Change the audio sound track on multi-audio sound track DVD discs. Change the sound mode of VCD discs
32	TITLE	Display the TITLE menu stored on DVD disc

Ref #	Button	Function
33	EQ	Select the equalization mode, such as CLASSIC, POP, ROCK
34	<</TRACK	Search in reverse rapidly
35	>>/TRACK	Search forward rapidly
36	0-9	Enter track/chapter number directly. Use GOTO to search.
37	GOTO	Used with numeric buttons to search disc
38		Press to mute/resume audio.

BASIC OPERATION

Turning the Unit On/Off

Press the **POWER**  button (1) on the front panel or remote control to turn the unit on/off.

Inserting a Disc

Insert a disc, label side up, into the disc slot (12). The player will start playback automatically.



Ejecting a Disc

Press the **EJECT** button (3) to eject the disc from the slot. The unit does not have to be on to eject a disc.

NOTE: Do not drive with an ejected disc in the slot.

Audio Control

Volume

Press the **VOL**  button (8) to increase the volume, or the **VOL**  button (9) to decrease the volume.

Mute

Press the **MUTE** button (6) to silence the audio. Press **MUTE** again to resume audio.

Press the **SEL** button (10) on the front panel or remote control to select the desired audio adjustment mode. The adjustment mode will change in the following order:

Bass	Press SEL until "BAS" appears in the display.	Press the volume buttons to adjust the Bass from +06 to -06.
Treble	Press SEL until "TRE" appears in the display.	Press the volume buttons to adjust the Treble from +06 to -06.
Balance	Press SEL until "BAL" appears in the display.	Press the volume buttons to adjust the Balance from 12L to 12R.

Clock Display

Press the **T/F** button (21) to alternate between playing time and clock time.

Setting the Clock

Press and hold the **T/F** button (21) on the remote until the clock display flashes, and then release. Next, press < (29) or |<< (7) to adjust the hour and > (29) or >>| (4) to adjust the minutes. Continue changing the hour to move between AM and PM.

Mode

Press the **MODE** button (11) on the front panel or remote control to switch between disc (DVD/VCD/CD/MP3) mode, AV IN1, or AV IN2 mode.

Equalization

Press the **EQ** button (33) on the remote control to activate the equalization function. Continue pressing the **EQ** button to choose between the three equalizer modes (CLASSIC, POP and ROCK) or to turn the equalizer function off (DSP OFF).

Reset

The **RESET** button (16) is located on the front of the unit. You should engage the **RESET** button only in the following situations:

- After initial installation when all wiring is complete
- If all function buttons become inoperable
- If an error symbol appears on the display

To reset the unit, use a ballpoint pen or a thin metal object to depress the **RESET** button.

AV In Operation

You can connect another audio/video system to the unit through the AV IN terminals on the back (AV1 INPUT) or front panel (AV2 INPUT) of the unit. Once the device is connected, press the **MODE** button (11) on the front panel or remote control to select "AV IN1" or "AV IN2" mode.

CD/DVD/VCD OPERATION

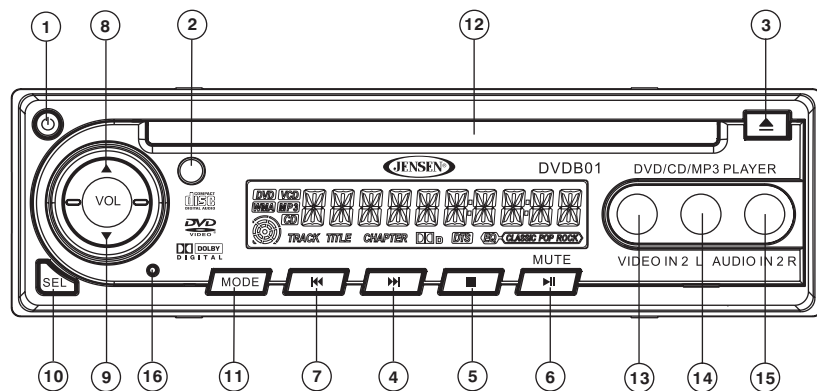

Stopping Play

- Press the stop ■ button (5) on the front panel or remote control to stop disc play. Press the >|| button (6) to resume normal playback.
- Press the stop ■ button (5) on the front panel or remote control twice to stop the playback and return to the initial chapter.

Moving Through Chapters/Tracks

- Press the >>| button (4) on the unit or remote control to advance to the next chapter/track.
- Press the |<< button (7) on the unit or remote control to move to the previous chapter/track.

Fast Forward/Fast Backward

Press the >>| button (35) on the remote control to fast forward. Keep pressing and releasing the button to increase the rate from "2X" to "4X", "8X" and "20X". Press the >|| button (6) to return to regular playback. *Press and hold* to fast-forward to a specific location. Release to begin playback from that point.

Press the <<| button (34) on the remote control to fast backward. Keep pressing and releasing the button to increase the rate from "2X" to "4X", "8X", and "20X". Press the >|| button (6) to return to regular playback. *Press and hold* to fast backward to a specific location. Release to begin playback from that point.

Pausing Playback

Press the >|| button (6) on the unit or the >|| button on the remote control during playback to temporarily stop playback. To return to normal playback, press the >|| button again.

Repeating Playback

Press the **RPT** button (20) on the remote control to select the repeat mode as follows:

DVD: CHAPTER > TITLE > REP ALL > OFF

VCD/CD: REP 1 > REP ALL > OFF

- Select CHAPTER to continuously repeat the current chapter.
- Select TITLE to continuously repeat the current title.
- Select REP 1 to continuously repeat the current track.
- Select REP ALL to continuously repeat all chapters/tracks on the current disc. After playing the last chapter/track, the unit will stop and display the elapsed time.

NOTE: The REPEAT feature does not support VCD 2.0 (with PBC ON).

PBC (Play Back Control) (VCD Only)

For VCDs with play back functionality, play back control (PBC) provides additional controls for VCD playback.

Press the **MENU** button (24) on remote control to toggle the PBC function "On"/"Off". Once PBC is on, playback starts from track one of the play list.

NOTE: During VCD playback you can press the **LANG** button (31) on the remote control during playback to switch the sound between mono and stereo sound in the following order: MONO LEFT > MONO RIGHT > STEREO.

Zooming

The Zoom function allows you to increase the picture size. Press the **ZOOM** button (26) on the remote control to toggle from 2X to 3X to 4X scale and then to 1/2, 1/3 and 1/4 scale. When the scale is 1/4X, press **ZOOM** again to select OFF and cancel the Zoom function.

During Zoom mode, press the arrow (<, >, Λ, V) buttons (29) to move the picture up, down, left, or right.

Random Play (CD/VCD Only)

Press the **SHUFFLE** button (19) on the remote control to select and play tracks in random order. The display will show "RANDOM". Press the >|| button to begin the shuffled playback. Press the **SHUFFLE** button again to turn shuffle off.

Remote Control Direct Track Entry

To select a track directly, use the number pad on the remote control (36). For single digit entries, press the corresponding number. For two digit entries, press the **10+** button (27) followed by the last digit (i.e., for track 16, press **10+** and then **6**).

Goto Search

During DVD or VCD playback, perform the following steps to use the GOTO feature to access a specific location on a disc:

Title/Chapter Search

To play a specific title/chapter:

1. Press the **GOTO** button (37) button. The On Screen Display information will appear with the track/chapter number highlighted (TRK 00/00).
2. Use the arrow (<, >, Λ, V) buttons (29) to move the cursor to the time field.
3. Use the numeric buttons (36) on the remote control to enter the desired title/chapter number.
4. Press the **ENTER** button (30).

Time Search

To enter an exact playback starting point:

1. Press the **GOTO** button (37).
2. When the On Screen Display information appears at the top of the screen, use the arrow (<, >, Λ, V) buttons (29) to move the cursor to the time field (00:00:00).
3. Use the numeric buttons (36) on the remote control to enter the playback starting point.
4. Press the **ENTER** button (30).

Playing in Programmed Order (CD/VCD)

1. Press the **PROG** button (18) to access the programmed playback screen:

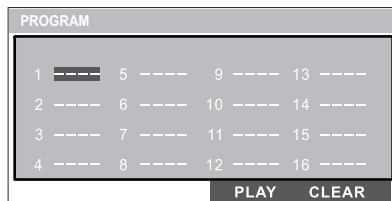

2. Use the arrow (<, >, Λ, V) buttons (29) on the remote control to access the fields on the "PROGRAM" screen.
3. Use the number buttons on the remote control to enter a track number in each field.
4. Press the >|| button (6) on the remote control or highlight "PLAY" on screen and then press the **ENTER** button (30) to begin playback in the numbered order indicated.
1. To delete the list, highlight "CLEAR" and then press **ENTER**. Press **PROG** to exit the programmed playback screen.

On-Screen Display Function

Press the display (□) button (17) during playback to view playback information at the top of the screen.

DVD Playback Information

The following information is displayed at the top of the screen during DVD playback:

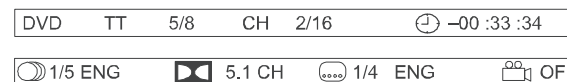

- TT 5/8 – "5 / 8" indicates the fifth of 8 titles on the DVD is currently playing.
- CH 2/16 – "2 / 16" indicates that the second of 16 chapters on the DVD is currently playing.
- Press □ repeatedly to view the following information: for elapsed/remaining playing time:
 - 00:02:18 – total elapsed playing time for disc
 - C -00 :34 :37 – remaining playing time
 - T 00:02:18 – total elapsed playing time for current track
 - C -00 :34 :37 – remaining playing time for current track
- 1/5 ENG – English is the selected audio language out of 5 possible choices
- 5.1 CH – The current language is recorded in 5.1 surround sound
- 1/4 ENG – English is the selected subtitle language out of 4 possible choices
- OFF – There are no alternate angles recorded for this scene

VCD Playback Information

The following information is displayed at the top of the screen during VCD playback:





- TRK ###/### – "1/18" indicates the first of 18 tracks on the VCD is currently playing.
- PBC: Indicates when PBC (Playback Control) is turned on.
- X – "X" indicates repeat play is OFF, "1" indicates repeat track, "D" indicates repeat directory, and "A" indicates repeat disc.
- Press □ repeatedly to view the following information for elapsed/remaining playing time:
 - 00:02:18 – total elapsed playing time for disc
 - C -00 :34 :37 – remaining playing time
 - T 00:02:18 – total elapsed playing time for current track
 - C -00 :34 :37 – remaining playing time for current track

CD Playback Information

The following information is displayed at the top of the screen during CD playback:



- TRK #### – “1/18” indicates the first of 18 tracks on the CD is currently playing.
-  – “X” indicates repeat play is OFF, “1” indicates repeat track, and “A” indicates repeat disc.
- Press  repeatedly to view the following information for elapsed/remaining playing time:
 -  00:02:18 – total elapsed playing time for disc
 - C-00 :34 :37 – remaining playing time
 - T 00:02:18 – total elapsed playing time for current track
 - C -00 :34 :37 – remaining playing time for current track

Multi-Language Discs (DVD Only)

Changing Audio Language

If you are watching a disc recorded in multiple languages, press the **LANG** button (31) on the remote control to choose a language. If no other languages are recorded, “INVALID KEY” is displayed in the top left corner of the screen.

Changing Subtitle Language

If you are watching a disc recorded in multiple languages with subtitles, press the  button (22) on the remote control to choose the language in which you would like the subtitles to appear. If no other languages are available, “INVALID KEY” is displayed in the top left corner of the screen.

Menu Function (DVD Only)

Press the **MENU** button (24) on the remote control while the disc is playing to display the disc root menu. You can navigate with the remote control navigation keys and select a feature with the **ENTER** button (30) on the remote control.

Title Menu Function (DVD Only)

If the DVD has multiple titles recorded on the disc, you can select a specific title from the title menu from which to start playback.

1. Press the **TITLE** button (32) on the remote control during playback to display the title menu.
2. Select the preferred title using the remote control arrow keys (29) and confirm by pressing the **ENTER** (30) button.

Viewing an Alternate Picture Angle (DVD Only)

Some DVDs contain scenes that have been shot simultaneously from different angles. For discs recorded with multiple angles, press the **ANGLE** button (23) on the remote control to toggle available angles of the on-screen image. If no other angles are recorded, “INVALID KEY” is displayed in the top left corner of the screen.

MP3 OPERATION

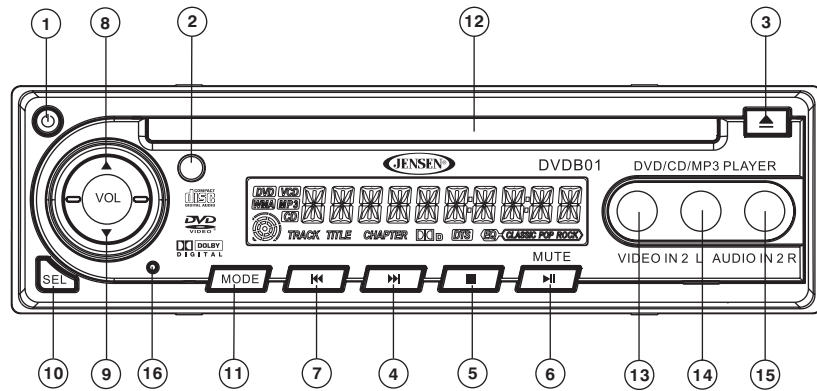

Insert/Eject Disc

Insert a disc label-side up into the disc slot (12), and the disc will begin to play. Press the eject button (3) to stop playback and eject the disc.



NOTE: MP4 streaming video format is not supported.

MP3 Monitor Display

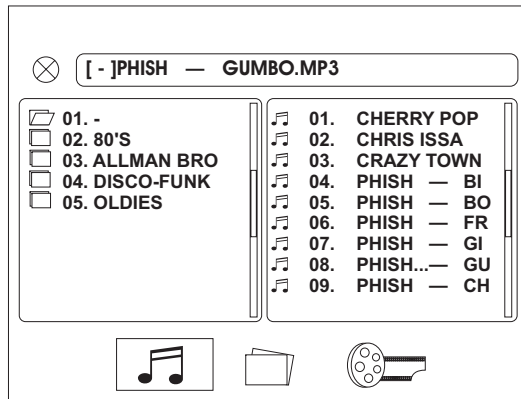

After loading an MP3 disc, the following screen will appear on your output monitor.



Select one of these icons to access the corresponding media on your disc or USB device. If the media type is not present, the icon will not be selectable.

-  : Audio
-  : Photos
-  : Video

Stopping Play

- Press the stop  button (5) on the front panel or remote control to stop disc play.
- Press the >|| button (6) to resume normal playback.
- Press the stop  button (5) on the front panel or remote control twice to stop the playback and return to the initial chapter.

Moving Through Chapters/Tracks

- Press the >>| button (4) on the unit or remote control to advance to the next chapter/track.
- Press the |<< button (7) on the unit or remote control to move to the previous chapter/track.

File/Folder Navigation

Press the arrow (<, >, ^, v) buttons (29) to navigate the on-screen display to choose folders/files when playing and MP3 disc. Press the ENTER button (30) to select.

Fast Forward/Fast Backward

Press the >> button (35) on the remote control to fast forward. Keep pressing and releasing the button to increase the rate from "2X" to "4X", "8X" and "20X". Press the >|| button (6) to return to regular playback. *Press and hold* to fast-forward to a specific location. Release to begin playback from that point.

Press the << button (34) on the remote control to fast backward. Keep pressing and releasing the button to increase the rate from "2X" to "4X", "8X", and "20X". Press the >|| button (6) to return to regular playback. *Press and hold* to fast backward to a specific location. Release to begin playback from that point.

Pausing Playback

Press the >|| button (6) on the unit or the >|| button on the remote control during playback to temporarily stop playback. To return to normal playback, press the >|| button again.

Repeating Playback

Press the RPT button (20) on the remote control to select the repeat mode as follows:

REP 1 > REP DIR > REP ALL > OFF

- Select REP 1 to continuously repeat the current file.
- Select REP DIR to to continuously repeat the current directory/folder.
- Select REP ALL to continuously repeat all files on the current disc. After playing the last file, the unit will stop and display the elapsed time.

Random Playback

Press the **SHUFFLE** button (19) on the remote control to select and play tracks in random order. The display will show "RANDOM". Press the **>||** button to begin the shuffled playback. Press the **SHUFFLE** button again to turn shuffle off.

Playing in Programmed Order

1. Press the **PROG** button (18) to access the programmed playback screen:

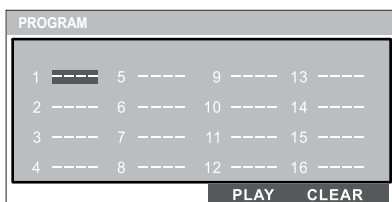

2. Use the arrow (<, >, ^, v) buttons (29) on the remote control to access the fields on the "PROGRAM" screen.
3. Use the number buttons on the remote control to enter a file number in each field.
4. Press the **>||** button (6) on the remote control or highlight "PLAY" on screen and then press the **ENTER** button (30) to begin playback in the numbered order indicated.
5. To delete the list, highlight "CLEAR" and then press **ENTER**. Press **PROG** to exit the programmed playback screen.

Remote Control Direct File Entry

To select a file directly, use the number pad on the remote control (36). For single digit entries, press the corresponding number. For two digit entries, press the **10+** button (27) followed by the last digit (i.e., for file 16, press **10+** and then **6**).

GOTO Direct File Access

Use the GOTO function to access a file directly.

1. Press the **GOTO** button (37) on the remote control. The On Screen Display information will appear with the file number highlighted.
2. Use the number keys on the remote control to enter the 3-digit file number directly (i.e. for file 10, enter "010").
3. Press the **ENTER** button to confirm and begin playback.

On-Screen Display Function

Press the display () button (17) during playback to view playback information at the top of the screen.

MP3 Playback Information

The following information is displayed at the top of the screen during CD playback:

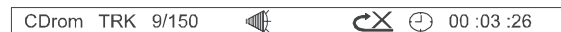

- TRK #### – "9/150" indicates the ninth of 150 tracks on the disc is currently playing.
- – "X" indicates repeat play is OFF, "1" indicates repeat song, and "D" indicates repeat directory (folder).
- Press repeatedly to view the following information for elapsed/remaining playing time:
 - 00:02:18 – total elapsed playing time for disc
 - C-00:34:37 – remaining playing time for disc

DVD SETUP MENU

Press the  (setup) button (29) on the remote control to access the SYSTEM SETUP menu and adjust system settings for the following categories:

- System Setup
- Language Setup
- Audio Setup
- Video Setup
- Digital Setup

Use the arrow (<, >) buttons (29) to choose between SYSTEM, LANGUAGE, or VIDEO setup options.

While in the setup menus, use the (<, >, ^, v) buttons (29) to select and change settings. The “up” and “down” arrows highlight the options, and the “right” and “left” arrows will change the setting for the highlighted option.

System Setup

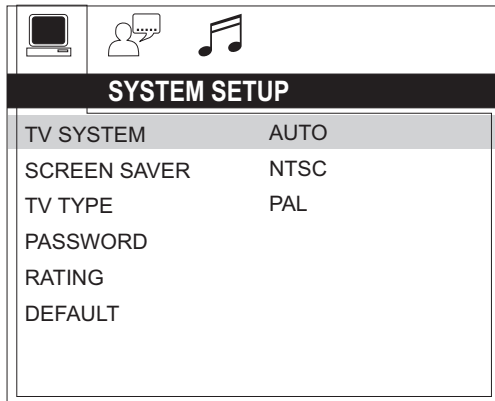

The System Setup menu controls the following features:

TV SYSTEM: This item is used to select a TV signal system to match your TV set. Select one of the following options: AUTO, NTSC or PAL.

SCREEN SAVER: Turn Screen Saver feature On/Off.

TV TYPE: Select one of the following picture formats: 4:3PS, 4:3LB or 16:9. 4:3 is a letterbox selection, and 16:9 is wide screen.

- 4:3PS: Image is played back in the PAN SCAN style. (If connected to a wide-screen TV, the left and right edges are cut off.)
- 4:3 LB: Image is played back in letter box style. (If connected to a wide-screen TV, black bands appear at the top and bottom of the screen.)
- 16:9: Select this option when a wide-screen TV set is connected.

PASSWORD: This item allows the selection of a new four-digit code to use for security purposes.

RATING: Select the parental control level for all DVD play. The security password is required to make changes to this feature.

DEFAULT: Use this item to restore default settings at any time.

Language Setup

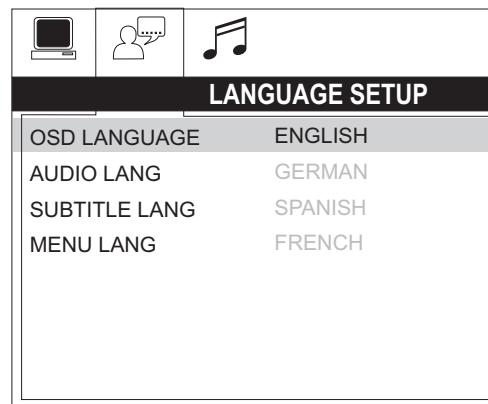

The Language Setup menu controls the following features:

On-Screen Display (OSD) Language: Set the OSD language to one of the following: English, German, Spanish or French.

Audio Language: Set the audio language to one of the following: Chinese, English, Japan, French, Spanish, Russian, Latin or German.

Subtitle Language: Set the subtitle language to one of the following: Chinese, English, Japan, French, Spanish, Russian, German or OFF.

Menu Language: Set the menu language to one of the following: Chinese, English, Japan, French, Spanish, Russian, German or Latin.

Audio Setup

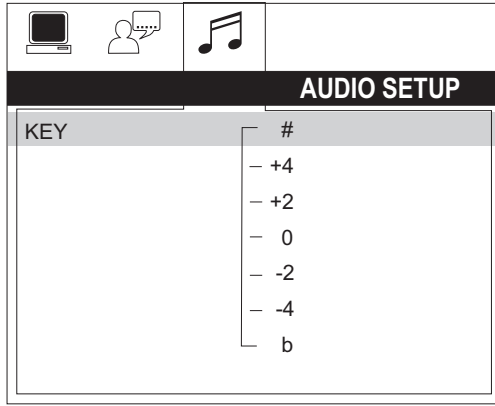

The Audio Setup menu controls the following features:

Key: This item changes the audio output key.

DISC SYMBOLS AND PROPERTIES

Table 1: Disc Properties









Symbol	12cm Disc Properties	Max Play Time
	Single side single layer (DVD-5) Single side double layer (DVD-9) Double side single layer (DVD-10) Double side double layer (DVD-18)	(MPEG 2 Method) 133 minutes 242 minutes 266 minutes 484 minutes
	Single side single layer (Video CD)	(MPEG 1 Method) 74 minutes
	Single side single layer	74 minutes
	Single side single layer	74 minutes

Table 2: DVD Disc Symbols

Symbol	Meaning
	Number of voice languages recorded. The number inside the icon indicates the number languages on the disc (maximum of 8).
	Number of subtitle languages available on the disc (maximum of 32).
	Number of angles provided (maximum of 9).
	Aspect ratios available. "LB" stands for Letter Box and "PS" stands for Pan/Scan. In the example on the left, the 16:9 video can be converted to Letter Box video.
	Indicates the region code where the disc can be played. <ul style="list-style-type: none"> • Region 1: USA, Canada, East Pacific Ocean Islands • Region 2: Japan, Western Europe, Northern Europe, Egypt, South Africa, Middle East • Region 3: Taiwan, Hong Kong, South Korea, Thailand, Indonesia, South-East Asia • Region 4: Australia, New Zealand, Middle and South America, South Pacific Ocean Islands/Oceania • Region 5: Russia, Mongolia, India, Middle Asia, Eastern Europe, North Korea, North Africa, North-West Asia • Region 6: Mainland China • ALL: All regions

NOTE: The following types of discs will not play in this unit: DVD-ROM, DVD-RAM, CDV, CD-G. DVD-R discs WILL play in this unit.

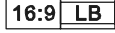
TROUBLESHOOTING

Problem	Cause	Corrective Action
Unit will not power on	Radio Fuse blown	Install new fuse with correct rating
	Car battery fuse blown	Install new fuse with correct rating
	Illegal operation	Press the RESET button located in the bottom right corner of the front panel
Remote control does not function	Battery depleted	Replace battery with new one
	Battery installed incorrectly	Remove battery and install correctly
Poor sound quality or distortion	Pirated disc is in use	Use original copy
Unit resets itself when engine is off	Incorrect connection between ACC and positive battery wire	Check wiring and correct
Cannot insert disc	Disc already inside unit	Eject current disc and insert new one
Disc does not play back	Disc is warped or scratched	Use disc in good condition
	Disc is dirty or wet	Clean disc with soft cloth
	Laser pickup is dirty	Clean laser pickup with cleaning disc
	Incompatible disc is used	Use compatible disc
	Disc region code is not compatible with unit	Use disc with proper region code
	Disc is inserted upside down	Insert disc with label side up
Image blurred, distorted, or dark	Disc is illegally copied	Use original disc
PBC cannot be used during VCD playback	PBC is not available on the disc	
No repeat or searching while playing VCD	PBC is on	Turn PBC off

Care and Maintenance

- Use only a clean silicone cloth and neutral detergent to clean the front panel or monitor. A rough cloth and non-neutral detergent (such as alcohol) may result in scratching or discoloration.
 - Do not get water or cleaning fluids on the unit.
 - If the temperature inside the player gets too hot, a protective circuit automatically stops play of the disc. If this occurs, allow the unit to cool before operating the player again.
 - Never insert anything other than a 5" (12 cm) compact disc into the player as the mechanism can be damaged by foreign objects.
 - Do not attempt to use a 3" (8 cm) CD-Single disc in this unit, either with or without an adaptor, as damage to the player and/or disc may occur. Such damage is not covered by the Warranty on this product.
 - The ventilation should not be impeded by covering the ventilation openings with items such as newspapers, table-cloths, curtains, etc.
 - The DVD player may not operate properly in extreme hot or cold. If such conditions occur, allow the interior of the vehicle to reach a normal temperature before using player.
- When the vehicle warms up during cold weather or under damp conditions, condensation may appear on the LCD panel. Should this occur, the screen will not operate properly until the moisture has evaporated.
 - We suggest you use a cleaning disc in this unit more frequently than in the unit in your home due to the environmental conditions of the vehicle.

SPECIFICATIONS

Supply Voltage: 12V DC (11V-15V), negative ground

Current Consumption: Less than 2A

Signal System: Composite video 1.0Vp-p 75ohms

Discs Played:

1. DVD-VIDEO disc
 - 5" (12 cm) single-sided, single-layer
 - 5" (12 cm) single-sided, double-layer
2. Compact disc (CD-DA/CD-R/CD-RW/MP3)
3. 5" (12 cm) VIDEO CD

Audio Output Level: 10kohms (2 ch 2.0 Vrms)

Audio Signal Output:

- Frequency response: 20Hz~20kHz
- S/N ratio: 80dB(JIS)
- Wow and Flutter below measurable limits

Specifications subject to change without notice.

This device complies with Part 15 of the FCC Rules. Operation is subject to the following two conditions:

- (1) This device may not cause harmful interference.
- (2) This device must accept any interference received, including interference that may cause undesired operation.

NOTE: The manufacturer is not responsible for any radio or TV interference caused by unauthorized modifications to this equipment. Such modifications could void the User's authority to operate the equipment.

LIMITED WARRANTY

90 Day / 12 Month Limited Warranty

AUDIOVOX SPECIALIZED APPLICATIONS, LLC (the Company) warrants to the original retail purchaser of this product that should this product or any part thereof, under normal use and conditions, be proven defective in material or workmanship within 90 days from the date of original purchase, such defect(s) will be repaired or replaced (at the Company's option) without charge for parts and repair labor. After the initial 90 day period and for a period of 12 months from the date of the original purchase, the Company will supply at no charge a replacement for any defective part(s).

To obtain repair or replacement within the terms of this warranty, the end user should contact the O.E.M. The product is to be delivered to the OEM or original place of purchase, with proof of warranty coverage (e.g. dated bill of sale, and serial number of the unit, and vin#), specification of defect(s), transportation prepaid, to an approved warranty station. This warranty does not extend to the elimination of externally generated static or noise, to the correction of antenna problems, to costs incurred for removal or reinstallation of the product, or to damage to any tapes, cd's, dvd's, speakers, accessories, or electrical systems. This warranty does not apply to any product or part thereof which, in the opinion of the Company, has been damaged through alteration, improper installation, mishandling, misuse, neglect, or accident. THE EXTENT OF THE COMPANY'S LIABILITY UNDER THIS WARRANTY IS LIMITED TO THE REPAIR OR REPLACEMENT PROVIDED ABOVE, AND, IN NO EVENT, SHALL THE COMPANY'S LIABILITY EXCEED THE PURCHASE PRICE PAID BY THE PURCHASER FOR THE PRODUCT.

This warranty is in lieu of all other express warranties or liabilities. ANY IMPLIED WARRANTIES, INCLUDING ANY IMPLIED WARRANTY OF MERCHANTABILITY, SHALL BE LIMITED TO THE DURATION OF THIS WARRANTY. ANY ACTION FOR BREACH OF ANY WARRANTY HEREUNDER INCLUDING ANY IMPLIED WARRANTY OF MERCHANTABILITY MUST BE BROUGHT WITHIN A PERIOD OF 30 DAYS FROM THE DATE OF ORIGINAL PURCHASE. IN NO CASE SHALL THE COMPANY BE LIABLE FOR ANY CONSEQUENTIAL OR INCIDENTAL DAMAGES FOR BREACH OF THIS OR ANY OTHER WARRANTY, EXPRESS OR IMPLIED WHATSOEVER. No person or representative is authorized to assume for the Company any liability other than that expressed herein in connection with the sale of this product.

Some states do not allow limitations on how long an implied warranty lasts or the exclusion or limitation of incidental or consequential damages so the above limitations or exclusions may not apply to you. This warranty gives you specific legal rights and you may also have other rights which vary from state to state.



ASA Electronics Corporation

www.asaelectronics.com

www.jensenrdirect.com

© 2009 ASA Electronics Corporation

v.061709

Free Manuals Download Website

<http://myh66.com>

<http://usermanuals.us>

<http://www.somanuals.com>

<http://www.4manuals.cc>

<http://www.manual-lib.com>

<http://www.404manual.com>

<http://www.luxmanual.com>

<http://aubethermostatmanual.com>

Golf course search by state

<http://golfingnear.com>

Email search by domain

<http://emailbydomain.com>

Auto manuals search

<http://auto.somanuals.com>

TV manuals search

<http://tv.somanuals.com>