

JENSEN®

MODEL JDTV-350
Portable ATSC Digital TV with 3.5" TFT LCD

**PLEASE READ THIS USER MANUAL COMPLETELY BEFORE
OPERATING THIS UNIT AND RETAIN THIS BOOKLET FOR
FUTURE REFERENCE.**

CONTENTS

Important Safety Instructions	
Compliance with FCC Regulations	
Dear Jensen Customer	
Accessories Included	
Power Source and Recharging	
Battery Warnings	
Replacing the Rechargeable Battery Pack	
Lithium Battery Safety Instructions	
TV Controls	
Using the Antennas	
Getting Started	
Function Menus and Settings	
Picture	
Audio	
Time	
Setup	
Channel	
Care and Maintenance	
Troubleshooting	
Specifications	
90 Day Limited Warranty and Service	

IMPORTANT SAFETY INSTRUCTIONS

TO PREVENT FIRE OR ELECTRICAL SHOCK HAZARD AND OTHER INJURIES, DO NOT EXPOSE THIS APPARATUS TO RAIN OR MOISTURE.

1. Read these instructions.
2. Keep these instructions.
3. Heed all warnings.
4. Follow all instructions.
5. Do not use this apparatus near water.
6. Cleaning - Unplug ac adaptor from this product from the wall outlet before cleaning. Do not use liquid cleaners or aerosol cleaners. Clean only with dry cloth.
7. Do not block any ventilation openings. Install in accordance with the manufacturer's instructions.
8. Do not place this product on an unstable cart, stand, tripod, bracket, or table. The product may fall, causing serious injury to a child or adult, and serious damage to the product. Use only with a cart, stand, tripod, bracket, or table recommended by the manufacturer, or sold with the product.
9. Do not install near any heat sources such as radiators, heat registers, stoves, or other apparatus (including amplifiers) that product heat.
10. Protect the power cord of the ac adaptor from being walked on or pinched particularly at plugs, convenience receptacles, and the point where they exit from the apparatus.
11. Only use attachments/accessories specified by the manufacturer.
12. Unplug this apparatus during lightening storms or when unused for a long periods of time.
13. This appliance shall not be exposed to dripping or splashing water and that no object filled with liquids such as vases shall be placed on the apparatus.
14. Do not overload wall outlet. Use only power source as indicated.
15. Use replacement part as specified by the manufacturer.
16. Power Sources - This product should be operated only from the type of power source indicated on the marking label. If you are not sure of the type of power supply to your home, consult your product dealer. For products intended to operate from battery power, or other sources, refer to the operating instruction.
17. Object and Liquid Entry - Never push objects of any kind into this product through openings as they may touch dangerous voltage points or short-out parts that could result in a fire or electric shock. Never spill liquid of any kind on the product.
18. Damage Requiring Service - Unplug this product from the wall outlet and refer servicing to qualified service personnel under the following conditions:
 - a) When the power-supply cord or plug is damaged,
 - b) If liquid has been spilled, or objects have fallen into the product,
 - c) If the product has been exposed to rain or water,
 - d) If the product does not operate normally by following the operating instructions. Adjust only those controls that are covered by the operating instructions as an improper adjustment of other controls may result in damage and will often require extensive work by a qualified technician to restore the product to its normal operation.
 - e) If the product has been dropped or damaged in any way, and
 - f) When the product exhibits a distinct change in performance - this indicates a need for service.



SAVE THESE INSTRUCTIONS

COMPLIANCE WITH FCC REGULATIONS

This equipment has been tested and found to comply with the limits for a TV receiver, pursuant to Part 15 of the FCC Rules. These limits are designed to provide reasonable protection against harmful interference in a residential installation. This equipment generates, uses and can radiate radio frequency energy and, if not installed and used in accordance with the instructions, may cause harmful interference to radio communications. However, there is no guarantee that interference will not occur in a particular installation. If this equipment does cause harmful interference to radio or television reception, which can be determined by turning the equipment off and on, the user is encouraged to try to correct the interference by one or more of the following measures:

- Reorient or relocate the receiving antenna.
- Increase the separation between the equipment and receiver.
- Connect the equipment into an outlet on a circuit different from that to which the receiver is connected.
- Consult the dealer or an experienced radio/TV technician for help.

WARNING

Changes or modifications to this unit not expressly approved by the party responsible for compliance could void the user's authority to operate the equipment.

DEAR JENSEN CUSTOMER

Selecting fine audio-visual equipment such as this TV unit you've just purchased is only the start of your enjoyment. Now it's time to consider how you can maximize the fun and excitement your equipment offers. This manufacturer and the Electronic Industries Association's Consumer Electronics Group want you to get the most out of your equipment by playing it at a safe level. One that lets the sound come through loud and clear without annoying blaring or distortion and, most importantly, without affecting your sensitive hearing.

Sound can be deceiving. Over time your hearing "comfort level" adapts to higher volumes of sound. So what sounds "normal" can actually be loud and harmful to your hearing. Guard against this by setting your equipment at a safe level BEFORE your hearing adapts.

To establish a safe level:

- Start your volume control at a low setting.
- Slowly increase the sound until you can hear it comfortably and clearly, and without distortion.

Once you have established a comfortable sound level:

- Set the volume control and leave it there.

Taking a minute to do this now will help to prevent hearing damage or loss in the future. After all, we want you listening for a lifetime.

We Want You Listening For a Lifetime

Used wisely, your new TV equipment will provide a lifetime of fun and enjoyment. Since hearing damage from loud noise is often undetectable until it is too late, this manufacturer and the Electronic Industries Association's Consumer Electronics Group recommend you avoid prolonged exposure to excessive noise.

Customer's Record:

The serial number of this product is found on its bottom. You should note the serial number of this unit in the space provided as a permanent record of your purchase to aid in identification in the event of theft or loss.

Model Number: JDTV-350

Serial Number: _____



ACCESSORIES INCLUDED

The followings have been included with your TV set:

- User Manual
- Quick Guide
- AC Adaptor (5V \equiv 1.5A \oplus - \ominus - \ominus)
- Li-ion Rechargeable Battery Pack (3.7V \equiv 2000mAh)
- External Antenna with MCX connector
- Stereo earbuds
- Protective pouch

POWER SOURCE AND RECHARGING

This TV operates on an included Li-ion battery pack and must be charged prior to use.

Please charge the TV for at least 6 hours before first use.

1. Set the TV Power Switch to Off. Plug the included AC Adaptor (5V=1.5A) into the DC Jack of the TV.
2. Once fully charged, you can watch the TV for about 2 hours. The average recharging time is approximately 5 hours for normal use.
3. To stop the charging process, disconnect the AC Adaptor.
4. When the battery power becomes low, the low battery indicator will pop up in the lower right corner of the screen as shown, please recharge as soon as possible or otherwise the unit will shut down on its own.



Notes

- While recharging, you may watch the TV as usual but charging time will be extended.
- Do not overcharge the player after the initial charge. Overcharging could shorten the battery's life and charging capacity.
- The Li-ion battery pack will normally offer up to 500 charge/discharge cycles.
- The Li-ion battery will discharge slowly on its own even when the unit is not in use, so if the unit is not used for an extended period of time it will be necessary to recharge the unit at least once every couple months to maintain normal performance.

Battery Warnings

1. The battery could cause injury or explode if incorrectly replaced. Replacement should be by a qualified technician and only with the same or equivalent type of battery.
2. Do not disassemble, crush, short-circuit or incinerate your battery as it may cause fire, injury, burns, explosion or other hazards.
3. Please dispose of properly for recycling.

Replacing the Rechargeable Battery Pack

After regular use over a period of time, the internal battery pack may store less and less energy per recharge than when it was fresh or even fails to recharge. If that happens, follows the procedure below to replace it:

1. Set the On/Off Switch of the TV to "OFF".
2. Open the Battery Compartment Cover and carefully unplug the old battery pack from the TV unit. Then gently plug in a new battery pack as shown. Note that the plug is polarized and fit in one direction only.
3. Replace the battery compartment cover securely.



Lithium Battery Safety Instructions

Do not burn or bury batteries. Do not puncture or crush. Do not disassemble.

Recycle lithium batteries. Do not dispose of in the trash.

If the electrolyte in the cells should get on your skin, thoroughly wash with soap and water. If in the eyes, rinse thoroughly with cool water. Immediately seek medical attention.

Use only chargers rated for lithium cells. Be sure the charger's voltage and current settings are correct for the battery pack being charged.

Charge batteries on a fireproof surface away from flammable items or liquids.

Batteries should NEVER be left unattended while charging. Only adults should charge the batteries.

Follow the manufacturer's instructions for charging the product and do not charge longer than recommended.

Unplug the charger when the battery is charged.



Recycle Rechargeable Batteries

Recycle your old rechargeable batteries at one of the many collection sites in the U.S. and Canada. To find the site nearest you, visit www.call2recycle.org or call toll-free 1-877-2-RECYCLE.

TV CONTROLS

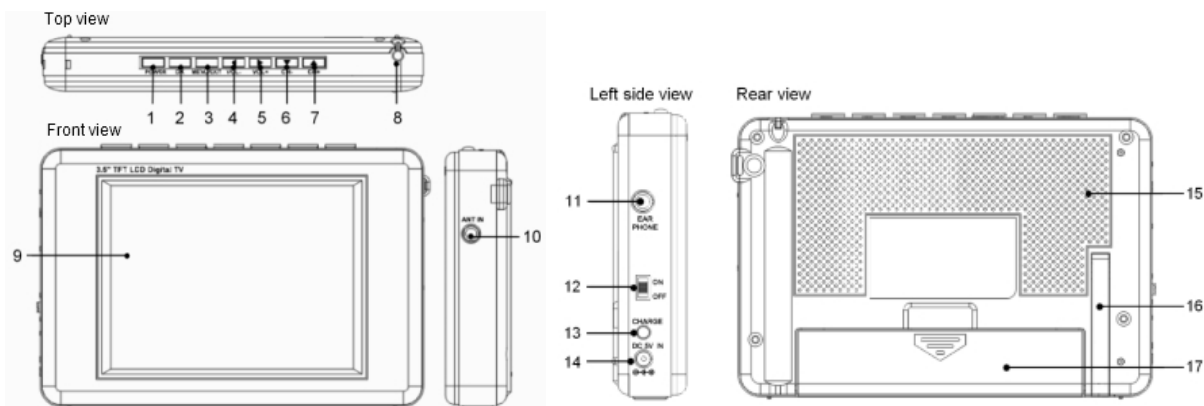

Control	Function
1. POWER	Press to switch unit between On and Standby mode.
2. OK (ENTER)	Press to choose a menu item or confirm a setting.
3. MENU/EXIT	While in TV mode, press to bring up the main function menu. Inside a function menu, press to end setting mode. Press again to return to TV mode.
4. VOL-	While watching TV, press to decrease the volume output. While in main menu, press to select previous function menu, e.g. Audio. Inside in a function menu, press to change the setting of the selected menu item.
5. VOL+	While watching TV, press to increase the volume output. While in main menu, press to select next function menu, e.g. Audio. Inside in a function menu, press to change the setting of the selected menu item.
6. CH-	While watching TV, press to recall the previous captured TV channel. While in main menu, press to select the first menu item for user adjustment. Inside in a function menu, press to move the selection bar down the list.
7. CH+	While watching TV, press to recall the next captured TV channel. Inside in a function menu, press to move the selection bar up the list.
8. Built-in Antenna	Fully extend this telescopic antenna for best indoor or outdoor reception. Tips: when receiving weak signal in the upper channels, folding back the last section may help to improve picture stability.
9. TFT Color Screen	This 4:3 screen delivers vivid pictures at 320H x 240V resolution.
10. Antenna Input	This jack accepts the external monopole antenna included with your TV set
11. Headphone Jack	This jack accepts a pair of stereo earbuds with a standard 3.5mm plug
12. On/Off Switch	This is the main power on/off switch. Always switch to "off" if you are not using the TV set for the next few hours to conserve battery power.
13. Charge Indicator	<ul style="list-style-type: none"> • It will light steadily when the AC adaptor is connected and On/Off Switch is set to "OFF". • It will flash when On/Off Switch is set to "ON" while battery is being recharged. • It will go off when the AC adaptor is connected and battery has been fully charged or the TV is operating on battery power.
14. DC Jack	This jack accepts the included AC adaptor for normal operation and charging.
15. Speaker Grille	Do not block these holes where speaker sound is emitted. They also serve as ventilation openings while TV is in operation.
16. Foldout Stand	Fold out the stand if you want to keep the TV set upright.
17. Battery Compartment Cover	Remove this cover to disconnect the internal Li-ion battery pack for replacement when necessary.

USING THE ANTENNAS

For normal outdoor use, fully extend the built-in antenna for best signal reception.

Reception of a stable picture may be impaired if:

- buildings or tall trees are blocking the broadcasting signals;
- it is snowing or raining heavily;
- you are moving along with your TV set;
- you are operating the TV set inside a moving vehicle;
- there are external interferences due to other RF devices nearby.

Notes

- Digital TV reception requires the TV set to be stationary while watching.
- Keep the built-in antenna stored folded and away from any fast moving or current carrying appliances such as a working fan.

If pixilation of the picture or weak reception occurs, try using the included magnetic base external antenna to improve the reception.

Fully extend the antenna cable and plug the MCX connector of the external antenna into the Antenna Jack of the TV set. Then try placing the external antenna in different locations, e.g. a window, until a stable picture can be obtained. The external antenna has a magnetic base for you to attach securely to a metal (iron) surface for improved reception.

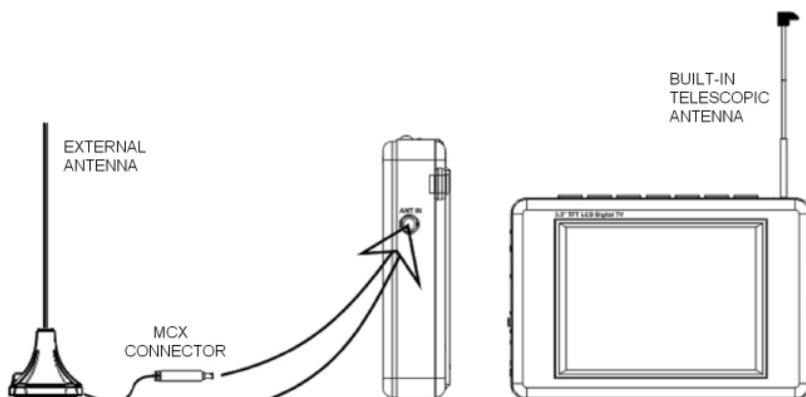

GETTING STARTED

When first powered on and there is no channel information stored in the memory, the TV screen will show a dialog for auto scan setup, press OK button to start auto scan mode.

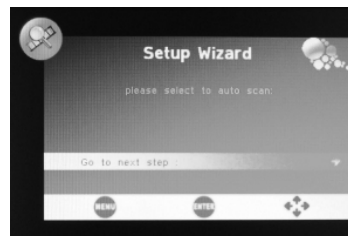

FUNCTION MENUS AND SETTINGS

There are 5 different menus: Picture, Audio, Time, Setup and Channel.

- Press MENU button to bring up the main menu.
- Press VOL+ or VOL- to select a menu.
- Press CH- button to select the first menu item and use VOL+ or VOL- button to adjust.
- Press EXIT button to finish settings and press again to return to normal TV mode.

PICTURE

1. Picture mode: Standard (default), Dynamic, Soft, Personal.
2. Contrast: 0 -100 (default is 50).
3. Brightness: 0 -100 (default is 50).
4. Sharpness: 0 -100 (default is 50).
5. Tint: 0 -100 (default is 50).
6. Color: 0 -100 (default is 50).
7. Color mode: Normal, Warm, Cool (default), Personal.
8. Zoom Mode: Wide (default), Zoom, Cinema, Normal.

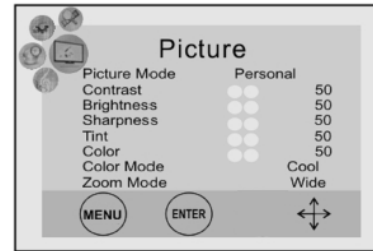

AUDIO

1. Audio Language mode: English (default), French, Spanish.
2. Balance: 0 -100 (default is 50).



TIME

1. Sleep Timer: Off (default), 5, 10, 15, 30, 45, 60, 90, 120, 180, 240.
2. Time zone: Pacific (default), Alaska, Hawaii, Atlantic, Eastern, Central, Mountain.
3. DST (Daylight Saving Time): On or Off (default).
4. Time format: 12-hour (default) or 24-hour.
5. Clock: this will display the current time using information transmitted with the receiving TV program.



SETUP

1. Menu (OSD) language: OSD English (default), French, Spanish.
2. Transparent: 0%, 25%(default), 50%, 75%, 100%.
3. OSD Time Out: 5sec, 15sec (default), 30sec, 45sec, 60sec.

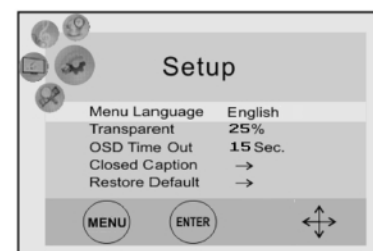

4. Closed caption:
 - (a) CC Mode: Select the CC display options from CC off (default), CC On, CC on mute.
 - (b) Basic Selection: Select the CC type options from CC1 (default), CC2, CC3, CC4, Text1, Text2, Text3, Text4, Off.
 - (c) Advanced selection: Select the CC on type options: Service1 (default), Service2, Service3, Service4, Service5, Service6, Off.
 - (d) Option Mode: there are more options on font style, foreground/background color/opacity, select Custom to make further adjustments:
 - (i) Font style: Select the CC font options: Default, Font 0, Font 1, Font 2, Font 3, Font 4.
 - (ii) FG color: Default, White, Red, Green, Blue, Yellow, Magenta, Cyan.

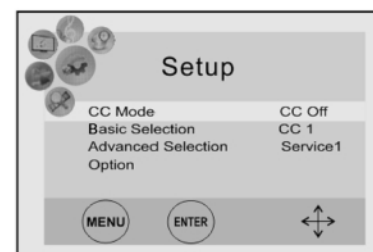

- (iii) BG color: Default, Black, Red, Green, Blue, Yellow, Magenta, Cyan.
 - (iv) FG opacity: Default, Solid, Flashing, Translucent, Transparent.
 - (v) BG opacity: Default, Solid, Flashing, Translucent, Transparent.
5. Restore Default: chose this to clear all personal preferences & settings and restore to factory default settings.

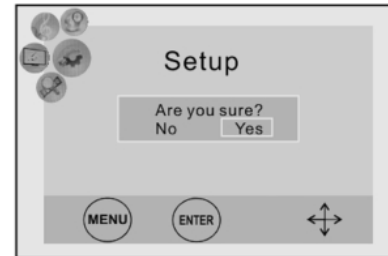
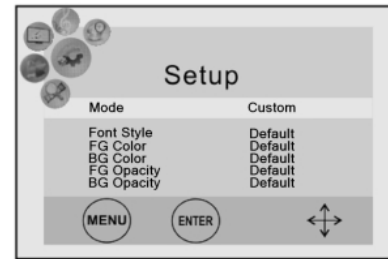

CHANNEL

1. Auto Scan:

When selected, will automatically seek out all available channels in your viewing area. Make sure the antenna is fully extended or you are using the external magnetic base antenna prior to scanning for channels.

- (i) Press the CH- button to scroll down to Auto Scan.
- (ii) Press the OK button to start the scan
- (iii) Once the scan is complete, the TV will automatically start playing the lowest channel found.
- (iv) You can now use the CH+ and CH- buttons to change the channels.



2. Show/Hide

Allows you to edit the channels you want shown on the TV once the scan is completed.

- (i) Use the CH- to scroll down to Show/Hide
- (ii) Press OK to enter.
- (iii) A list of all the channels found will display and a "V" will be shown next to the channel if it will show up when using the CH+ and CH- buttons during normal operation.
- (iv) Press the CH- button to scroll down through the channels.
- (v) Press the OK button to show the channel ("V" shown next to the channel) or to hide the channel (no "V" shown next to the channel).
- (vi) Press the MENU/EXIT button three times to return to normal viewing.

3. Channel No.

Displays the current channel you are currently viewing.

4. Channel Label

Displays the call letters of the TV station you are currently viewing.

- (i) You can edit the channel label by pressing the OK button.
- (ii) Use the VOL+/- and CH+/- buttons to edit the name you want displayed for the channel.
- (iii) Press the OK button when completed.

5. DTV Signal

Displays the signal strength or the TV station you are currently viewing.

CARE AND MAINTENANCE

1. Children should be supervised when using this TV set.

2. Never wrap the earbud or ac adaptor cord around any animal or person. Special care should be taken with long wires.
3. Fold back the delicate telescopic antenna when not in use to avoid possible damage.
4. Clean your unit with a damp (never wet) and lint-free cloth. Solvent or detergent should never be used. The TV panel should only be cleaned with special cleaning agent formulated for such purpose.
5. Avoid leaving your unit in direct sunlight or in hot, humid or dusty places.
6. Keep your unit away from heating appliances and sources of electrical noise such as fluorescent lamps or motors.

TROUBLESHOOTING

Problems	Possible Causes	Possible Solutions
TV cannot turn on	<ul style="list-style-type: none"> • Internal battery is exhausted. • Power On/Off switch is set to "off". 	<ul style="list-style-type: none"> • Recharge battery with provided ac adaptor. • Set Power On/Off switch is set to "on"
No picture received	<ul style="list-style-type: none"> • Signal is weak. • Receiving channel is not in service. 	<ul style="list-style-type: none"> • Fully extend the built-in antenna or change to the external antenna provided. • Try other TV channels.
Picture is pixilated	<ul style="list-style-type: none"> • Signal is weak. • Watching TV in a moving vehicle or user is walking 	<ul style="list-style-type: none"> • Fully extend the built-in antenna or change to the external antenna provided and try different locations. • Watch TV programs only when the TV is stationary.
Bright or dim pixels on TV screen	<ul style="list-style-type: none"> • This is due to possible manufacturing defects. 	<ul style="list-style-type: none"> • It is considered as acceptable if the total number of bright and dim pixels is not more than 4 at the corners.

SPECIFICATIONS

RF Reception	Terrestrial ATSC 8VSB: 54-860MHz (CH2 – 69)
Antennas	Built-in Antenna : telescopic, monopole type External Antenna : monopole type with 40-inch extension cord & MCX connector
Audio Processing	Digital Multi-lingual
Audio Output	Built-in Speaker and 3.5mm Headphone Jack
Video Processing	MPEG-2 Video Decoding, Terrestrial NTSC
TFT Color Panel	Size : 3.5 inches (diagonal) Resolution : 320H x 240V Aspect Ratio : 4:3
Power	Li-ion Battery Pack: 3.7V \approx 2000mAh AC Adaptor: 5V \approx 1.5A
Operating Temperature	14°F ~ 122°F (-10°C ~ 50°C)
Weight	6oz (170g)

90 DAY LIMITED WARRANTY AND SERVICE VALID IN THE U.S.A ONLY

SPECTRA MERCHANDISING INTERNATIONAL, INC. warrants this unit to be free from defective materials or factory workmanship for a period of 90 days from the date of original customer purchase and provided the product is utilized within the U.S.A. This warranty is not assignable or transferable. Our obligation under this warranty is the repair or replacement of the defective unit or any part thereof, except batteries, when it is returned to the SPECTRA Service Department, accompanied by proof of the date of original consumer purchase, such as a duplicated copy of a sales receipt.

You must pay all shipping charges required to ship the product to SPECTRA for warranty service. If the product is repaired or replaced under warranty, the return charges will be at SPECTRA's expense. There are no other express warranties other than those stated herein.

This warranty is valid only in accordance with the conditions set forth below:

1. The warranty applies to the SPECTRA product only while:
 - a. It remains in the possession of the original purchaser and proof of purchase is demonstrated.
 - b. It has not been subjected to accident, misuse, abuse, improper service, usage outside the descriptions and warnings covered within the user manual or non-SPECTRA approved modifications.
 - c. Claims are made within the warranty period.
2. This warranty does not cover damage or equipment failure caused by electrical wiring not in compliance with electrical codes or SPECTRA user manual specifications, or failure to provide reasonable care and necessary maintenance as outlined in the user manual.
3. Warranty of all SPECTRA products applies to residential use only and is void when products are used in a nonresidential environment or installed outside the United States.

This warranty gives you specific legal rights, and you may also have other rights which vary from state to state. TO OBTAIN SERVICE please remove all batteries (if any) and pack the unit carefully and send it prepaid by insured parcel post or UPS to SPECTRA at the address shown below. IF THE UNIT IS RETURNED WITHIN THE WARRANTY PERIOD shown above, please include a proof of purchase (dated cash register receipt) so that we may establish your eligibility for warranty service and repair of the unit without cost. Also include a note with a description explaining how the unit is defective. A customer service representative may need to contact you regarding the status of your repair, so include your name, address, phone number and e-mail address to speed the process.

IF THE UNIT IS OUTSIDE THE WARRANTY PERIOD, please include a check for \$65.00 to cover the cost of repair, handling and return postage. All out of warranty returns must be sent prepaid.

It is recommended that you contact SPECTRA first at 1-800-777-5331 or by e-mail at custserv@spectraintl.com for updated information on the unit requiring service. In some cases the model you have may be discontinued and SPECTRA reserves the right to offer alternative options for repair or replacement.

SPECTRA MERCHANDISING INTERNATIONAL, INC.
4230 North Normandy Avenue,
Chicago, IL60634, USA.
1-800-777-5331

To register your product, visit the link on the website below to enter your information.
<http://www.spectraintl.com/wform.htm>

Printed in China

Free Manuals Download Website

<http://myh66.com>

<http://usermanuals.us>

<http://www.somanuals.com>

<http://www.4manuals.cc>

<http://www.manual-lib.com>

<http://www.404manual.com>

<http://www.luxmanual.com>

<http://aubethermostatmanual.com>

Golf course search by state

<http://golfingnear.com>

Email search by domain

<http://emailbydomain.com>

Auto manuals search

<http://auto.somanuals.com>

TV manuals search

<http://tv.somanuals.com>