



HEAVY DUTY

JHD1620

AM/FM/RBDS/WB/AUX-IN/iPod Ready/SIRIUS Ready Heavy Duty Radio

Installation and Operation Manual

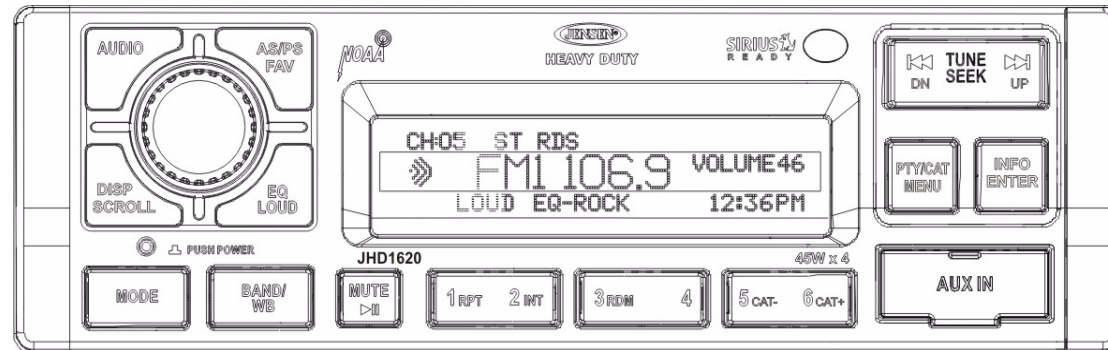

CONTENTS

Introduction	1
Safety Information	2
Installation	3
Wiring	4
Basic Operation	5
Tuner Operation	8
Satellite Radio Operation	10
iPod Operation	12
Care and Maintenance	13
Troubleshooting	13
Specifications	14

INTRODUCTION

System Features

Features of the Jensen JHD1620 mobile audio system include:

- Full Dot Matrix LCD
- AM/FM US/EURO Tuner with 30 Presets (12 AM, 18 FM)
- RBDS (Radio Broadcast Data Service) with PTY Search
- SIRIUS Radio Ready with Song Seek
- iPod Ready (Cable Sold Separately)
- Weatherband Tuner with SAME Technology
- Mute
- Pre-set Equalizer - 5 settings (Flat, Rock, Pop, Classical, User)
- Electronic Bass, Treble, Balance and Fader Controls
- Output Power 45W x 4
- Clock 12/24 Hour Selectable
- Public Announcement (PA) Feature with Optional Microphone (sold separately)
- IR Wireless Remote Control Ready (sold separately)
- 2-Channel Pre-amp Line Level Outputs
- 2-Wire Power with Non-Volatile Memory and Clock/Time Support
- Auxiliary Audio Input (Front 3.5mm Stereo Jack, Rear RCA)

Content List

- Jensen Heavy Duty Radio
- Hardware Kit
- 15AMP Fuse
- Installation Manual
- Quick reference Guide

HARDWARE KIT CONTENTS

FLANGE NUTS



MOUNTING STRAP

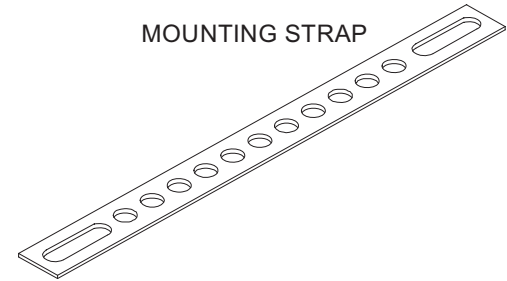

DIN SLEEVE
REMOVAL TOOL

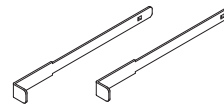

MOUNTING SCREW



MOUNTING BUSHING



SAFETY INFORMATION

When Driving

Keep the volume level low enough to be aware of the road and traffic conditions.

When Washing Your Vehicle

Do not expose the product to water or excessive moisture. Moisture can cause electrical shorts, fire or other damage.

When Parked

Parking in direct sunlight can produce very high temperatures inside your vehicle. Give the interior a chance to cool down before starting playback.

Use the Proper Power Supply

This product is designed to operate with a 12 volt DC negative ground battery system.

WARNING:

- TO REDUCE THE RISK OF FIRE OR ELECTRIC SHOCK, DO NOT EXPOSE THIS EQUIPMENT TO RAIN OR MOISTURE.
- TO REDUCE THE RISK OF FIRE OR ELECTRIC SHOCK AND ANNOYING INTERFERENCE, USE ONLY THE RECOMMENDED ACCESSORIES.

INSTALLATION

This unit is designed for installation in vehicle cabs with an existing 1-DIN radio opening. In many cases, a special installation kit will be required to mount the radio to the dashboard. See the dealer where the radio was purchased for kit availability. Always check the kit application before purchasing to make sure the kit works with your vehicle.

Before You Begin

1. **Disconnect Battery**
Before you begin, always disconnect the battery negative terminal.
2. **Remove Transport Screws**

Important Notes

- Before final installation, test the wiring connections to make sure the unit is connected properly and the system works.
- Use only the parts included with the unit to ensure proper installation. The use of unauthorized parts can cause malfunctions.
- Consult with your nearest dealer if installation requires the drilling of holes or other modifications to your vehicle.
- Install the unit where it does not interfere with driving and cannot injure passengers during a sudden or emergency stop.
- If the installation angle exceeds 30° from horizontal, the unit might not give optimum performance.
- Avoid installing the unit where it will be subject to high temperatures from direct sunlight, hot air, or from a heater, or subject to excessive dust, dirt or vibration.

DIN Front Mount

1. Slide the mounting sleeve off of the chassis if it has not already been removed. If it is locked into position, use the removal keys (supplied) to disengage it. The removal keys are depicted in "Removing the Unit" on page 3.
2. Check the dashboard opening size by sliding the mounting sleeve into it. If the opening is not large enough, carefully cut or file as necessary until the sleeve easily slides into the opening. Do not force the sleeve into the opening or cause it to bend or bow. Check that there will be sufficient space behind the dashboard for the radio chassis.
3. Locate the series of bend tabs along the top, bottom and sides of the mounting sleeve. With the sleeve fully inserted into the dashboard opening, bend as many of the tabs outward as necessary to firmly secure the sleeve to the dashboard.
4. Place the radio in front of the dashboard opening so the wiring can be brought through the mounting sleeve.
5. Follow the wiring diagram carefully and make certain all connections are secure and insulated with crimp connectors or electrical tape to ensure proper operation.
6. After completing the wiring connections, turn the unit on to confirm operation (vehicle accessory switch must be on). If the unit does not operate, recheck all wiring until the

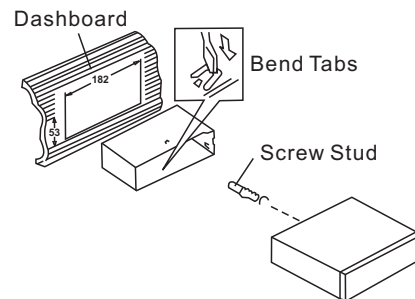

7. Carefully slide the radio into the mounting sleeve making sure it is right-side-up until it is fully seated and the spring clips lock it into place.
8. Attach one end of the perforated support strap (supplied) to the screw stud on the rear of the chassis using the hex nut provided. Fasten the other end of the perforated strap to a secure part of the dashboard either above or below the radio using the screw and plain washer provided. Bend the strap, as necessary, to position it. Some vehicle installations provide cavity for rear support. In these applications, place the rubber bushing over the screw stud and insert the radio.

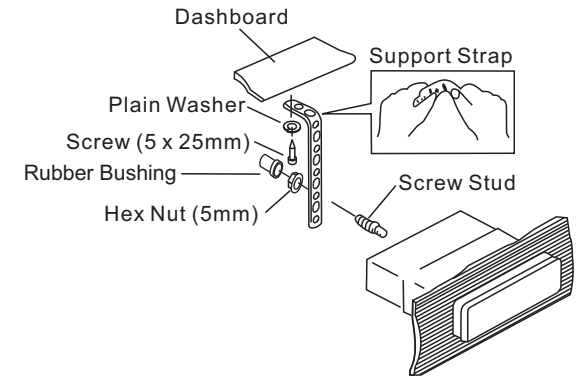

- CAUTION: The perforated rear support strap or rear rubber mounting bushing must be used in the installation of the radio. Installation without either may result in damage to the radio or the mounting surface and void the manufacturer's warranty.**
9. Test radio operation by referring to the operating instructions for the unit.

Removing the Unit

To remove the radio after installation, remove the plastic end caps, insert the removal keys straight back until they click, and then pull the radio out. If removal keys are inserted at an angle, they will not lock properly to release the unit.

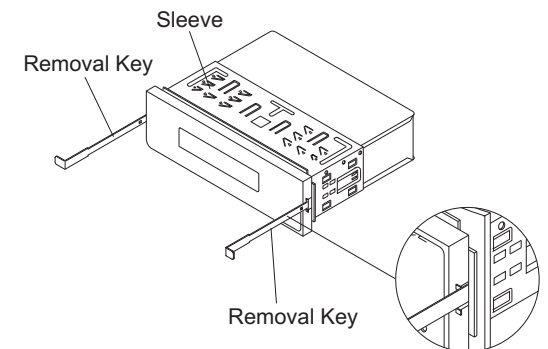

Reconnect Battery

When wiring is complete, reconnect the battery negative terminal.

WIRING

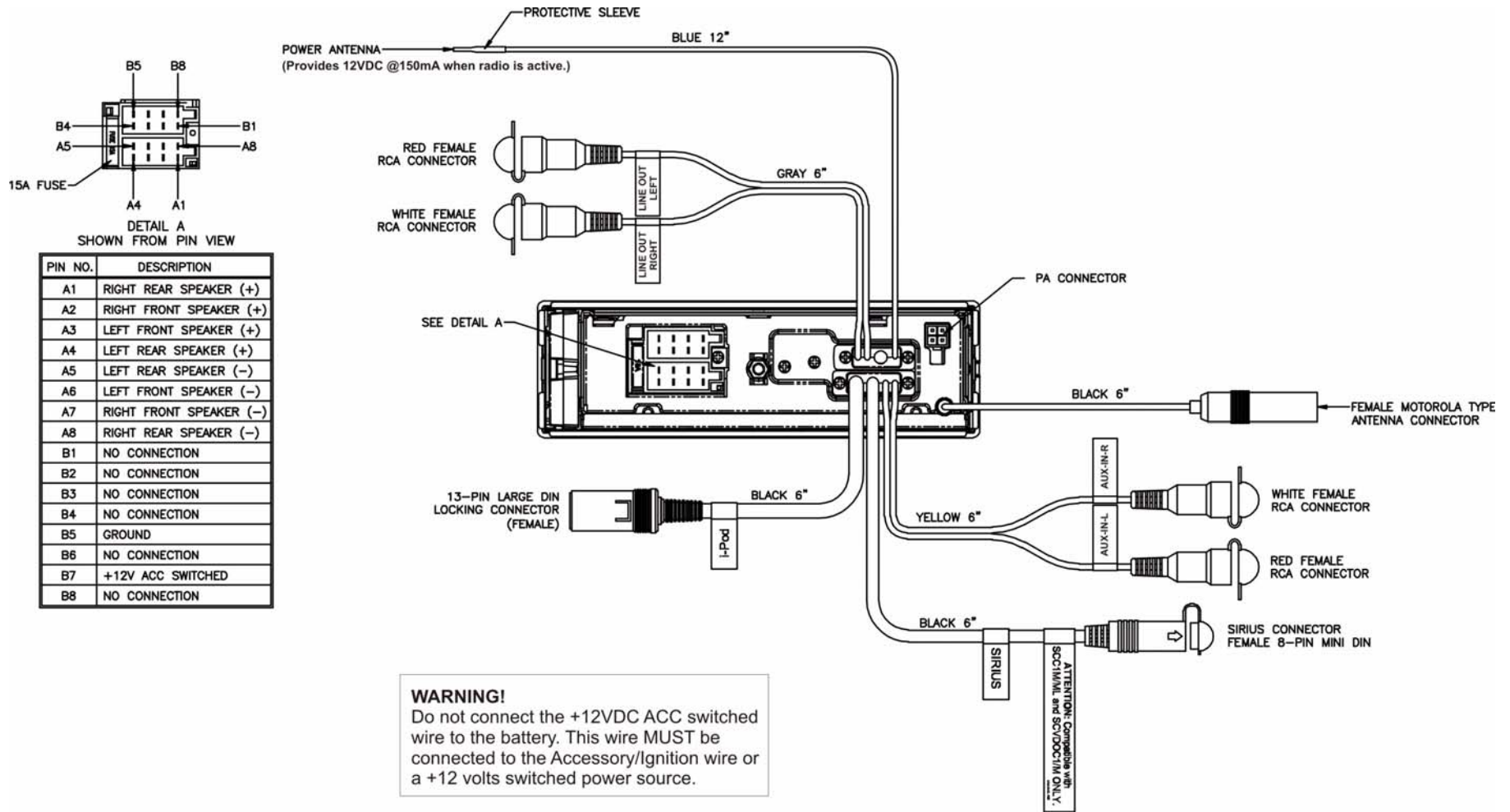

BASIC OPERATION

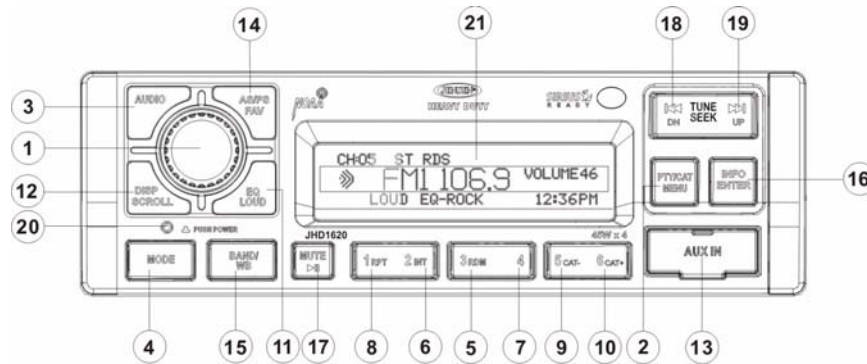

Power On/Off

Press the rotary encoder **POWER** button (1) to turn the unit on or off. The unit will resume at the last mode selected (Tuner, Auxiliary, etc.).

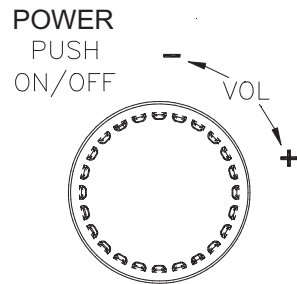

Volume Control

To increase the volume, turn the rotary encoder (1) to the right. To decrease the volume, turn the rotary encoder to the left. While adjusting the volume, the LCD displays a bar graph and numerical representation of the level.



The maximum volume setting is 40.

Mute

Press the **MUTE** button (17) to mute the audio output. Press **MUTE** again to restore the audio output to the previous level.

Mode

Press the **MODE** button (4) to select a different mode of operation, as indicated on the display panel. Available modes include the following: Tuner (AM/FM) > SAT (Sirius) > iPod > Auxiliary. Tuner is the default source when a prior source is no longer available.

NOTE: iPod or Sirius (SAT) mode will be skipped if the module is not installed.

NOTE: Sirius (SAT) mode will be skipped when the Region menu option is set to "EURO".

Reset

The reset button should be activated for the following reasons:

- initial installation of the unit when all wiring is completed
- function buttons do not operate
- error symbol on the display

Use a ball point pen or thin metal object to press the **RESET** button (20). This may be necessary should the unit display an error code.

Audio Menu

Press the **AUDIO** button (3) to access the audio menu. You can navigate through the audio menu items by pressing the **AUDIO** button repeatedly. Once the desired menu item appears on the display, adjust that option by turning the rotary encoder (1) within 5 seconds. The unit will automatically exit the audio menu after five seconds of inactivity. The following menu items can be adjusted.

Bass Level

Use the rotary encoder (1) to adjust the Bass level range from "-7" to "+7".

Treble Level

Use the rotary encoder (1) to adjust the Treble level range from "-7" to "+7".

Balance

Adjusting Balance controls the relative level between the left and right speakers in each pair. Use the rotary encoder (1) to adjust the Balance between the left and right speakers from "Left 12" to "Right 12".

Fader

Adjusting Fade controls the relative level between the front and rear speaker pairs. Use the rotary encoder (1) to adjust the Fader between the rear and front speakers from "Rear 12" to "Front 12".

System Menu

1. Press and hold the **PTY/CAT/MENU** button (2) for more than 2 seconds to enter the system menu. The first menu item, "Key Beep", will appear on the display.
2. Press the **TUNE/SEEK** |<< / >>| (18, 19) button repeatedly to navigate the system menu.
3. Press the **INFO/ENTER** button (16) to select the desired item.
4. Press the **INFO/ENTER** button again to adjust the selected menu item.

The following items can be adjusted:

- Key Beep (Click / Beep / Off): Turn the audible beep On/Off (heard when functions/ buttons are selected).
- LCD Backlight (1-10): Adjust LCD brightness.
- LCD Contrast (1-10): Adjust LCD contrast.
- Tuning Region (USA / EURO): Set frequency spacing for various regions.
- Power-Off Clock (On / Off)
- Clock Format (12Hour / 24Hour): Select 12 or 24 hour display mode.
- Set Clock (HH : MM):
 - Press the **INFO/ENTER** button (16) to view the clock set screen.
 - Press the **INFO/ENTER** button to move to the next digit.
 - Press the **TUNE/SEEK** |<< / >>| (18, 19) buttons to adjust the selected digit.
- Preset-Only Tuning (On / Off):
- Sirius Settings Menu (only appears when SIRIUS tuner is connected and in SIRIUS mode)
 - Clock Autoset (On / Off)
 - Time Zone1 (Atlantic / Eastern / Central / Mountain / Pacific / Alaska)
 - Daylight Saving Time (Observed / Not Observed)
 - Clear Skipped Channels (Yes / No)
 - Skipped Channels: List of Channels (Skipped / Visible)
 - Set Lock Code: _ _ _ _ _
 - Locked Channels: List of Channels (Locked / Unlocked)
 - Enable Song Seek (Yes / No)
 - Edit Favorite Songs: List of Favorite Songs (Enable / Disable / Delete)
- iPod Auto-Select (On / Off): Choose "On" to automatically detect and playback iPod when connected or "Off" to use the **MODE** button to select the iPod source.
- Weather Alert Configuration
 - Min Alert Level (All / None / Warnings / Watches)
 - Auto-On Enable (Yes / No): Select "Enabled" to turn on the radio when NOAA alerts are issued. This function only works when the +12V switched is on.
 - Alert Volume (Select Volume Level 0-40)
 - Clear SAME Codes <ENTER>
 - SAME Code 1: _ _ _ _ _
 - SAME Code 2: _ _ _ _ _
 - SAME Code 3: _ _ _ _ _
 - SAME Code 4: _ _ _ _ _
 - SAME Code 5: _ _ _ _ _
 - SAME Code 6: _ _ _ _ _
 - SAME Code 7: _ _ _ _ _
- Battery Alarm (Off / On)
- Battery Auto-Off (Off / On)
- Reset System Defaults <ENTER>: Press the **INFO/ENTER** button (16) to return the EEPROM to factory default set up values.

- Update Firmware <ENTER>: Press the **INFO/ENTER** button (16) to apply recent software updates.

Equalizer

Press the **EQ/LOUD** button (11) to choose one of the following pre-defined bass and treble curves: USER > FLAT > ROCK > CLASSICAL > POP.

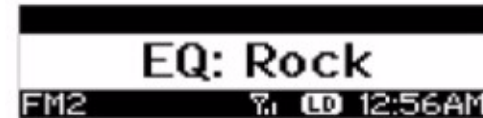

Loudness

Press and hold the **EQ/LOUD** button (11) to toggle loudness on/off. When listening to music at low volumes, this feature will boost the bass and treble ranges to compensate for the characteristics of human hearing.

Auxiliary Input

To access an auxiliary device:

1. Connect the portable audio player to either the AUX IN on the front panel (17) or at the rear of the unit.
2. Press the **MODE** button (4) to select "Auxiliary" mode. The rear AUX IN audio source will play by default until a device is inserted into the front jack.
3. Press **MODE** again to cancel "Auxiliary" mode and go to the next mode.

NOTE: The front AUX IN jack will override the rear auxiliary audio inputs.

PA Operation (microphone sold separately)

- Connect the PA Microphone with a 4-PIN connector to the 4-PIN socket on the rear of the unit.
- The unit will automatically switch to PA mode when the Mic switch is pushed "ON".
- The PA output level can be adjusted using the rotary volume encoder (1).
- With radio power off, the radio will wake up when PA mic is keyed to make an announcement. Please note that it will take a few seconds before the radio "wakes up" and PA is active. Radio will return to the off state when the PA mic is released.

Liquid Crystal Display (LCD)

The current frequency and activated functions are shown on the LCD panel (21).

NOTE: LCD panels may take longer to respond when subjected to cold temperatures for an extended period of time. In addition, the visibility of the characters on the LCD may decrease slightly. The LCD display will return to normal when the temperature increases to a normal range.

Setting the Clock

To set the clock to display the current time, turn the vehicle ignition on and turn the radio on. Enter the system menu and adjust the clock by selecting the "Set Clock" menu item.

- Press the **INFO/ENTER** button (16) to view the clock set screen.
- Press the **INFO/ENTER** button to move to the next digit.
- Press the **TUNE/SEEK** |<< / >>| (18, 19) buttons to adjust the selected digit.

When no adjustment is made for five seconds, the time will become set and normal operation will resume.

Scroll

When the information is too long to be displayed on the LCD, press the **DISP/SCROLL** button (12) to view the entire title. The information will scroll twice and then return to abbreviated text.

TUNER OPERATION

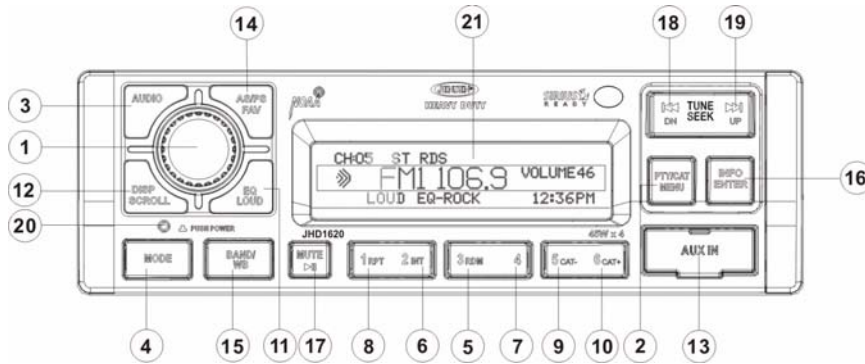

Select a Band

Press the **BAND/WB** button (15) to change between three FM bands and two AM bands. Press and hold the **BAND/WB** button to access the Weatherband (WB).

Manual Tuning

Press the **TUNE/SEEK** >>| or |<< buttons (19, 18) to seek stations up/down step by step.

Auto Seek Tuning

Press and hold the **TUNE/SEEK** >>| or |<< buttons (19, 18) to automatically seek the next or previous strong station.

NOTE: Seek tuning is not available for weather band channels. Use the up or down tuning buttons to manually select any of the seven available weather band channels.

Preset Stations

Six numbered preset buttons store and recall stations for each band.

Store a Station

Select a band (if needed), then select a station. Press and hold a preset button (5-10) for two seconds. The preset number will appear on the LCD.

Recall a Station

Select a band (if needed). Press a preset button (5-10) to select the corresponding stored station.

NOTE: Preset buttons are pre-assigned frequencies in weather band mode.

Automatically Store / Preset Scan (AS/PS)

Automatically Store

Select an AM or FM band. Press and hold the **AS/PS/FAV** button (14) for more than 2 seconds to automatically select 18 strong stations (12 for AM). "Storing Presets" appears on the screen and the new stations replace any stations already stored.

Preset Scan

Select a band. Press **AS/PS/FAV** (14) to scan stations stored in the current band. The unit will pause for 5 seconds at each preset station. Press **AS/PS/FAV** again to stop scanning when the desired station is reached.

RBDS Operation

This unit is equipped to display RBDS (Radio Broadcast Data Service) information when broadcast by the radio station.

NOTE: Radio stations broadcasting RBDS may not be available in your listening area.

In FM radio mode, press the **PTY/CAT/MENU** button (2) to list the following Program Type (PTY) options: ANY / News / Information / Sports / Talk / Rock / Classic Rock / Adult Hits / Soft Rock / Top 40 / Country / Oldies / Soft / Nostalgia / Jazz / Classical / Rhythm and Blues / Soft Rhythm & Blues / Foreign Language / Religious Music / Religious Talk / Personality / Public / College / Weather / Emergency Test / ALARM! ALARM!

To search for stations in a PTY category:

1. Press the **PTY/CAT/MENU** button (2) to view the current PTY category.
2. Press the **TUNE/SEEK** >>| or |<< buttons (19, 18) to move through the list of available categories and select the program type you wish to search.
3. After selecting the desired PTY, press the **PTY/CAT/MENU** button (2) to search the band for broadcasts of this type. "PTY Search" is displayed while the tuner is searching.

NOTE: Performing a PTY search on "ANY" will Seek Tune and stop on any station broadcasting RBDS, regardless of the program type.

Weather Band Operation

What is the NOAA Weather Radio/Weatheradio Canada?

NOAA (National Oceanic and Atmospheric Administration) is a nationwide system that broadcasts local weather emergency information 24 hours a day via the National Weather Service (NWS) network. The U.S. network has more than 530 stations covering the 50 states as well as the adjacent costal waters, Puerto Rico, the U.S. Virgin Islands and the U.S. Pacific Territories. Each local area has its own transmitting station and there are a total of seven broadcasting frequencies used. A similar system is available in Canada under the Weatheradio Canada service administered by Environment Canada.

Tuning to Weatherband

Press and hold the **BAND/WB** button (15) to access the Weatherband. The indication "WB" will appear on the display panel, along with the current number and channel indication: "WB-1", "WB-2", "WB-3", "WB-4", "WB-5", "WB-6" or "WB-7". The seven frequencies are shown in the following table:

Table 1: WB Frequencies

Frequency (MHz)	Preset
162.400	2
162.425	4
162.450	5
162.475	3
162.500	6
162.525	-
162.550	1

The above table also shows which preset button will access the frequency. Note that one frequency cannot be accessed using a preset button. The frequency can only be reached using the tuning controls.

Use the **TUNE/SEEK >>|** or **|<<** buttons (19, 18) or the preset buttons to tune to each of the seven channels until you find the weatherband station broadcasting in your area.

How many stations can I expect to receive?

Since the broadcasts are local weather and information, the transmission power is usually very low (much less than standard AM or FM stations) so you will usually receive only one station unless you are on the edge of two or more broadcast signals. The most you will receive will be two or three, and that is rare.

Is it possible I won't receive any stations?

Depending on where you are located, there is a possibility you will receive only a very weak signal or none at all. Also, similar to AM and FM signals, weatherband signals are subject to surrounding conditions, weather, obstructions of the signal by hills or mountains, etc.

NOAA Weather Alert

The Weather Alert function adds an additional level of user safety by automatically switching from any of the available function modes to weather band for a minimum of 60 seconds if a NOAA warning tone (1050 Hz) is received/detected. If no additional warning tone is received for 60 seconds, the unit will switch back to the last known function mode. See "System Menu" on page 6 to learn how to turn the WB Alert feature on.

SAME Decoding and Filtering

Specific Area Message Encoding (SAME) data is also broadcast prior to alert broadcasts. SAME data contains information about the geographic region affected by the alert, the type of alert, and its effective time. The geographic region included in the SAME data is called the Geographical Area code and has the form PSSCCC where "P" represents a portion of the county, "SS" is a two-digit state, territory, or offshore marine area identifier and "CCC" identifies the county, province, or major metropolitan area within the state. This unit can be configured through the system setting menu with up to seven Geographical Area codes to limit the automatic tuning or power on functions described above.

SAME data also includes the type of alert being broadcast. This unit can be configured through the System Setting Menu to limit the automatic tuning or power on functions based on the type of alert.

SAME is activated by programming a 6 digit code - called a FIPS code - into your radio. The FIPS code or Federal Information Processing System code is a six digit code that identifies the states and counties (or parishes) in the United States. The first digit identifies the county subdivision. The next two digits identify the state or territory, and the last three identify the county. The FIPS code for your area can be found by calling the NWS toll free number or visiting the web site.

The phone number is 1-888-NWS-SAME (1-888-697-7263) Upon calling, an automated system will prompt you to enter your state and county. When you confirm the information, the system will provide your six digit FIPS code.

The web site is: www.nws.noaa.gov/nwr/indexnw.htm. Upon selecting your state from the chart, you will see a listing of all the counties in that state. For each county there is a listing of the SAME# (FIPS code), the location of the transmitter, the WB frequency, the call sign, the transmitter power and miscellaneous remarks.

NOTE: Because broadcast areas overlap you may want to set more than one S.A.M.E. location. If you live near the border between counties, you may want to receive alerts from more than one tower.

Your radio is capable of being programmed with up to 7 different FIPS location codes. The default code has been programmed at the factory - 000000 - to respond to all messages within your area.

SATELLITE RADIO OPERATION

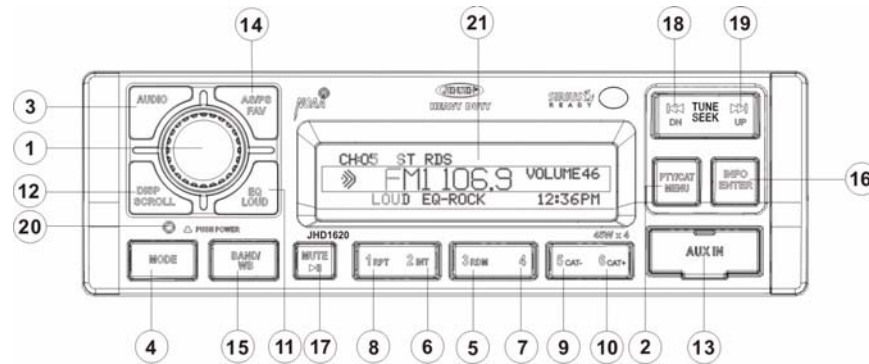

Switching to Sirius Satellite Radio (Requires optional Sirius tuner)

Press the **MODE** button (4) to change the mode to Sirius radio mode.

Accessing your Sirius RADIO ID

To display your Sirius radio ID, use the **TUNE/SEEK <</>>** button to tune to channel "000". The screen will display "Sirius ID" with the SID displayed in the middle of the LCD screen. The Sirius radio ID is 12 characters long.

Selecting a Band

In Sirius mode, press the **BAND/WB** button (15) to access the Sirius user-preset channel groups in the following order: SR1, SR2, SR3.

Category Tuning

1. Press the **PTY/CAT/MENU** button (2) to access Category mode.
2. While in category mode, press **5/CAT- OR 6/CAT+** buttons (9, 10) to choose a category.
3. Press the **TUNE/SEEK <</>>** buttons (18, 19) to choose desired channels in that category. (The current channel number within the chosen category will always be the default first channel tuned.)
4. Press the **PTY/CAT/MENU** button to return to channel tuning mode.

Channel Up/Down Tuning

Press the **TUNE/SEEK <</>>** buttons (18, 19) to search for a channel. *Press and hold* the **TUNE/SEEK** buttons to fast search.

Direct Tuning Mode

1. *Press and hold* the **INFO/ENTER** button (16) to enter direct tuning mode.
2. Press **TUNE/SEEK <</>>** buttons (18, 19) to change the first of three digits for the desired channel in the direct entry screen.
3. Press the **INFO/ENTER** button to confirm the entered digit and move to the second digit field.
4. Press **TUNE/SEEK <</>>** buttons to select the second digit.
5. Press the **INFO/ENTER** button to confirm the entered digit and move to the third digit field.
6. Press **TUNE/SEEK <</>>** buttons to select the third digit.
7. Press the **INFO/ENTER** button to confirm the three digit channel and tune to the selected channel.

Storing Preset Channels

The preset buttons (5-10) can be used to store 6 channels, allowing convenient access to your favorite channels.

Programming Channels

1. Select the channel you want to store in memory.
2. *Press and hold* a preset button (5-10) until the corresponding preset button number appears.
3. Repeat steps 1 and 2 to program additional channels.

Preset Recall

Press one of the six preset buttons (5-10) to directly select a preset channel stored in the current band.

Preset Scan

Press **AS/PS/FAV** button (14) to scan stations stored in all three user-preset channel groups (SR1, SR2 and SR3). The unit will pause for 10 seconds at each preset station. Press **AS/PS** again to stop scanning when the desired station is reached.

Preset Tuning

In Preset Tuning Mode, you can use the **TUNE/SEEK <</>>** buttons (18, 19) to access all 18 preset stations in sequential order. Access preset tuning mode through the system menu. Set Preset-Only Tuning to "ON."

Alternate Display Mode



Press the **DISP/SCROLL** button (12) to change the display information between single and dual line text display. In dual line mode, both artist and title are available for viewing.

Press and hold the **DISP/SCROLL** button to scroll the Artist/Song Title information.

While in category tuning list mode, press the **DISP/SCROLL** button in sequence to change the display information from Channel Name, Artist, and Song Title.



Satellite Signal Strength

The display will indicate satellite reception strength as shown below.

Signal Strength	Strength Display
No Signal	
Weak	
Good	
Excellent	

Channel Lock

Access Channel Lock through the System Menu under the "Sirius Satellite Radio" menu. See "System Menu" on page 6.

1. Select "Set Lock Code."
2. No channels can be locked with the default 0000 code. To set the lock code:
 - a. Press the **TUNE/SEEK** |<< / >>| (18, 19) buttons to enter the first digit of the default code.
 - b. Press the **INFO/ENTER** button to move to the next digit.
 - c. Repeat above steps to enter all 4 digits of the default code.
 - d. Press the **TUNE/SEEK** |<< / >>| (18, 19) buttons to enter the first digit of the new code.
 - e. Press the **INFO/ENTER** button to move to the next digit.
 - f. Repeat above steps to enter all 4 digits.
 - g. Repeat above steps to confirm the new code.
8. After setting a new four digit code, you can lock channels by entering the "Locked Channels" menu.
9. Upon entering the Locked Channels list, you will be prompted to enter your four digit code.
 - a. Press the **TUNE/SEEK** |<< / >>| (18, 19) buttons to enter the first digit.
 - b. Press the **INFO/ENTER** button to move to the next digit.
 - c. Repeat above steps to enter all 4 digits.
4. After entering the code, you can navigate the list using the **TUNE/SEEK** |<< / >>| buttons to highlight the channels.
5. Press the **INFO/ENTER** button (16) to Lock (indicated by a  icon) or Unlock () the selected channel.

Favorites (Song/Artist Seek)

This feature lets you store and search for up to 15 Artist/Song combinations on Sirius Satellite Radio.

1. While the current song is playing, press and hold the **AS/PS/FAV** button (14).
2. Press the **INFO/ENTER** button (16) to select the Artist to be stored or press the **AS/PS/FAV** button to select the Song to be stored.

Next time the stored artist or song is played on Sirius Satellite Radio, you will be notified with an alert and can then choose to tune to the channel playing the Song or Artist. The list of stored Artists/Songs can be managed through the System Menu under the "Sirius Satellite Radio" menu. See "System Menu" on page 6.

iPod OPERATION

This unit is equipped with an iPod ready function that will allow you to control your iPod (if compatible) using the control panel buttons. The following iPod versions are supported:

- iPod Nano (1G, 2G, 3G, 4G and 5G)
- iPod 5G
- iPod Classic
- iPhone, iPhone 3G, iPhone 3GS
- iPod Touch
- iPod Touch 2G

NOTE: Earlier model iPods are not supported because they do not implement the required control protocol. Also, the iPod Shuffle is not supported because it does not utilize the 30-pin Apple iPod Connector. These unsupported iPod models may be connected to the radio using one of the Auxiliary Inputs.

NOTE: iPod and iPod Cable sold separately.

Accessing iPod Mode

To enter iPod mode from any other source, press the **MODE** button (4) until "iPod" appears on the lower left corner of the display. If the user connects an iPod containing no songs, the radio will display a message stating "No Songs" when it enters iPod mode.

Turning the iPod On/Off

The iPod power turns on automatically when an iPod is connected to the 30-pin iPod cable, as long as the vehicle ignition is turned on. You can turn the iPod off by disconnecting it from the cable or by turning the ignition off. When the ignition is turned off, the iPod will pause and then enter sleep mode after 2 minutes. While the iPod is connected, the power cannot be turned on or off from the iPod itself.

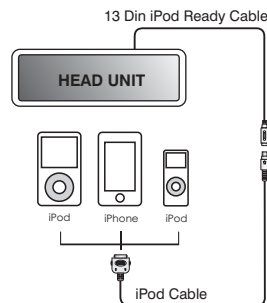

NOTE: The iPod will continuously recharge when connected to the unit, as long as the vehicle ignition is turned on.

Controlling Playback

Pausing Playback

During playback, press the **MUTE/>>|** button (17) to pause the iPod player. "Pause" will appear on the LCD. Press **MUTE/>>|** again to resume playback.

Repeat Play

During playback, press the **1/RPT** button (8) to repeat the current song. "RPT" will appear on the LCD. Press **1/RPT** again to stop repeat playback.

Intro Play

During playback, press the **2/INT** button (6) to play the first ten seconds of each song. "INT" will appear on the LCD. Press **2/INT** again to stop intro playback.

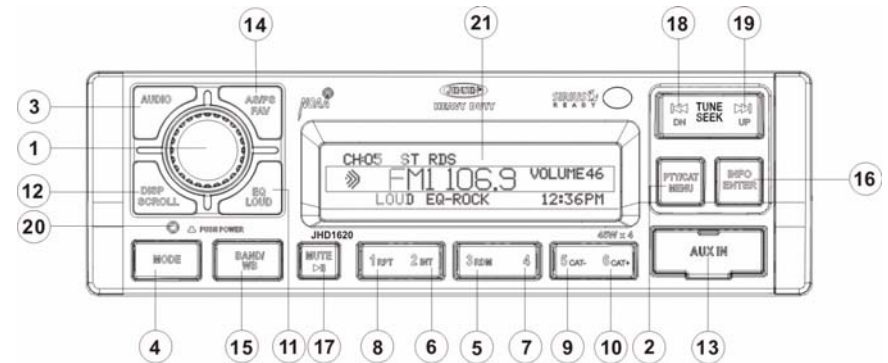

Random Play

During playback, press the **3/RDM** button (5) to play all songs in the current category in random order. Random play will begin once the current song has finished playing. "RDM" will appear on the LCD. Press **3/RDM** again to stop random playback.

Selecting Tracks

During playback, press the **TUNE/SEEK |<< / >>|** buttons (18, 19) to play the previous or next track in the current category. Press the **TUNE/SEEK |<<** button (18) once to play the song from the start position or press **TUNE/SEEK |<<** twice to play the previous track. Pressing the **TUNE/SEEK |<<** button (18) during the first 2 seconds of a track will play the previous track. After 2 seconds, this action returns to the beginning of the current track.

Press and hold the **TUNE/SEEK |<< / >>|** button (18, 19) to fast reverse/forward the song.

NOTE: If you press and hold the TUNE/SEEK |<< / >>| button to change the current song to the previous/next song, you will exit fast reverse/forward mode.

Playlist Search

Press the **PTY/CAT/MENU** button (2) to access Playlist selection mode. While in Category mode, press the **TUNE/SEEK |<< / >>|** buttons (18, 19) to choose file search by Playlist, Artist, Album, Genre, Song, Audiobook or Podcast. Press the **INFO/ENTER** button (16) to select the search mode. Use the **TUNE/SEEK |<< / >>|** buttons to search the available files on the iPod. Press the **INFO/ENTER** button to play the selected song or file.

Alternate Display Mode

Press the **DISP/SCROLL** button (12) to change the display information between single and double line text display.

CARE AND MAINTENANCE

- Keep the product dry. If it does get wet, wipe it dry immediately. Liquids might contain minerals that can corrode the electronic circuits.
- Keep the product away from dust and dirt, which can cause premature wear of parts.
- Handle the product gently and carefully. Dropping it can damage circuit boards and cases, and can cause the product to work improperly.
- Wipe the product with a dampened cloth occasionally to keep it looking new. Do not use harsh chemicals, cleaning solvents, or strong detergents to clean the product.
- Use and store the product only in normal temperature environments. High temperature can shorten the life of electronic devices, damage batteries, and distort or melt plastic parts.

Ignition

The most common source of noise in reception is the ignition system. This is a result of the radio being placed close to the ignition system (engine). This type of noise can be easily detected because it will vary in intensity of pitch with the speed of the engine.

Usually, the ignition noise can be suppressed considerably by using a radio suppression type high voltage ignition wire and suppressor resistor in the ignition system. (Most vehicles employ this wire and resistor but it may be necessary to check them for correct operation.) Another method of suppression is the use of additional noise suppressors. These can be obtained from most professional mobile electronics retailers.

Interference

Radio reception in a moving environment is very different from reception in a stationary environment (home). It is very important to understand the difference.

AM reception will deteriorate when passing under a bridge or when passing under high voltage lines. Although AM is subject to environmental noise, it has the ability to be received at great distance. This is because broadcasting signals follow the curvature of the earth and are reflected back by the upper atmosphere.

TROUBLESHOOTING

Symptom	Cause	Solution
No power	The vehicle's accessory switch is not on	If the power supply is properly connected to the vehicle's accessory terminal, switch the ignition key to "ACC" or "Run"
	The fuse is blown	Replace the fuse
No sound	Volume is too low or system is muted	Adjust volume to audible level
	Wiring is not properly connected	Check wiring connections
The operation keys do not work	The built-in microcomputer is not operating properly due to noise	Press the RESET button
Cannot tune to radio station, auto-seek does not work	The antenna cable is not connected	Check antenna cable
	The signals are too weak	Select a station manually

SPECIFICATIONS

FM Radio

Frequency Coverage (USA) 87.5 to 107.9 MHz
Frequency Coverage (Europe) 87.5 to 108 MHz
Sensitivity (S/N=30dB) 2.2 μ V
Image Rejection >45 dB
Stereo Separation >25 dB

AM/MW

Frequency Range (USA) 530-1710 kHz
Frequency Range (Europe) 522-1620 kHz
Sensitivity (S/N=20dB) 36 dB

General

Operating Voltage DC 12 Volts
Grounding System Negative Ground
Speaker Impedance 4-8 ohms per channel
Tone Controls:
 Bass (at 100 Hz) : \pm 10 dB
 Treble (at 10 kHz) : \pm 10 dB
Power Output 45W x 4
Idle/Standby Current 75mA
Current Drain 15 Ampere (max.)
Dimensions 175 (W) x 175 (D) x 50 (H)



ASA Electronics Corporation

www.asaelectronics.com

www.jensenheavyduty.com

©2010 ASA Electronics Corporation

v.120709

Free Manuals Download Website

<http://myh66.com>

<http://usermanuals.us>

<http://www.somanuals.com>

<http://www.4manuals.cc>

<http://www.manual-lib.com>

<http://www.404manual.com>

<http://www.luxmanual.com>

<http://aubethermostatmanual.com>

Golf course search by state

<http://golfingnear.com>

Email search by domain

<http://emailbydomain.com>

Auto manuals search

<http://auto.somanuals.com>

TV manuals search

<http://tv.somanuals.com>