

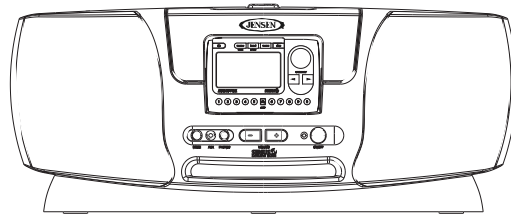

RECEIVER BOOM BOX JSIR900B User Guide



Released 03-07-05.

128-7369

1 of 12

Congratulations

You are one step closer to experiencing the latest innovation in Sirius Satellite Radio. Sirius will revolutionize your portable in-home, vehicle and family entertainment, such as camping trips and beach excursions, using the Sirius Model JSIR900B Boom Box as the base receptacle for your Receiver Receiver. Sirius entertainment will enhance your listening enjoyment with:

- 130 channels of original programming, including :
 - 65 channels of 100% commercial-free music – guaranteed;
 - Over 55 channels of world-class sports, news, talk and information.

Your Jensen Boom Box must be used with Receiver, Model JSIR900R (sold separately). Optional home and vehicle kits are available at retailers where Jensen main units are sold.

Jensen Home Kit: Part Number JSIR900H
Jensen Combo Kit: Part Number JSIR900CMB
Receiver and Car Kit

© 2004 SIRIUS Satellite Radio Inc. "SIRIUS" and the SIRIUS dog logo are registered trademarks of SIRIUS Satellite Radio Inc.

-2-

128-7369

2 of 12

FCC Regulations

This unit complies with the interference limits relative to a Class B digital device, applicable under Part 15 of the FCC Rules regarding installation in a residential environment. If the unit is not installed in accordance with these instructions, it could cause harmful interference to audio or television reception.

If this condition persists after corrective action, consult your dealer or experienced installation facility.

Cautions and Warnings

1. Within the home, do not install the Receiver Boom Box in a position that obstructs viewing of any home entertainment component, such as Television, or stereo system indicators and displays.
2. Do not install or use the JSIR900B in locations exposed to direct sunlight, or in areas subject to extreme temperatures; do not operate the unit in moist areas, in rain, or in areas adjacent to water such as pools, hot tubs, etc.
3. When outdoors, position the JSIR900B and antenna where there are no obvious satellite signal obstructions such as high terrain, trees, overhangs, etc.
4. When installed indoors, unplug the AC Power Adapter from the wall outlet when the JSIR900B is not to be used for an extended period of time. If batteries are installed, set the Power On/Off-VOL control to the Off position to prevent unintentional battery discharge, or remove the batteries.
5. To avoid possible damage to the Receiver Boom Box caused by battery leakage, it is recommended that the batteries be removed when the Boom Box is not being used for an extended period of time.
6. Do not install or place the JSIR900B on an inclined or unstable surface.
7. By adhering to these warnings and safety considerations, serious accidents and/or personal injury can be avoided.

-3-

128-7369

3 of 12

Contents JSIR900B

Users Guide
P/N 128-7369

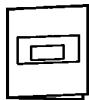

1 pc.

Antenna
(P/N 118C1129)



1 pc.



AC/DC Power Adapter
(P/N 136C3585)

AC Power Cord
(P/N 112B3376)

1 pc.

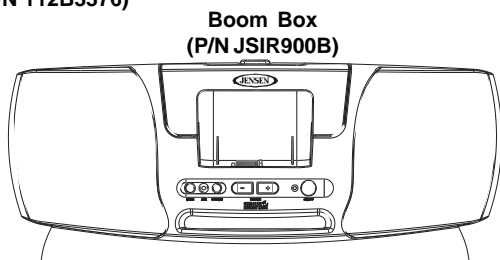

Boom Box
(P/N JSIR900B)

1 pc.

Installation/Wiring Precautions

1. If using the adapter, make sure the adapter cable is not connected to an AC wall outlet until all interconnections have been made and verified. The adapter power cable should be connected last.
2. Incorrect installation may cause damage to the system.
3. For antenna positioning, refer to the Antenna Aiming procedure outlined in the Receiver User Guide, JSIR900R (128-7373).

Setting Up and Installing Your Kit

NOTE: The SIRIUS® signal can be received and processed virtually anywhere as long as there are no obvious satellite signal obstructions such as high terrain, trees, overhangs, etc. However, signal reception depends mainly on where you are, geographically, and where this place is with respect to the orbital paths of the Sirius satellites. In placing the antenna, therefore, these factors must be taken into account .

-4-

128-7369

4 of 12

Boom Box JSIR900B Controls

The Jensen Sirius® Boom Box JSIR900B provides Power **ON/OFF** and **VOLUME +/-** pushbuttons, and a **MODE** pushbutton to toggle between Satellite Radio or an auxiliary audio input signal. A power-on/low battery LED is also located on the front panel.

1. **MODE Pushbutton:** This pushbutton toggles between Satellite Radio and an external audio input signal (MP3, CD, etc.) present at the AUX input jack.
2. **AUX Jack:** Accepts an audio input signal from an external audio device. When using the AUX audio input, turn the Receiver off to preserve battery power. Adjust the volume level of the external audio device to obtain an audio output from the JSIR900B. The volume control on the external audio device should be set to mid-range.

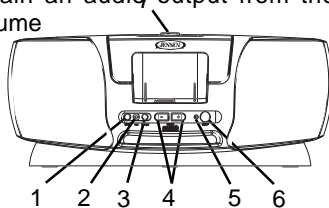

3. **PHONES Jack:** Accepts a stereo headphone jack to provide private listening capability for the Boom Box.
4. **VOLUME +/- Pushbuttons:** Increase or decrease the volume of the audio output signal from the JSIR900B. To increase the volume level, press the + pushbutton; to decrease the volume level, press the - pushbutton.

NOTE: When the JSIR900R Receiver is installed, the Volume buttons on the Remote Control unit will control the audio output of the Boom Box.

5. **Power On/Low Battery LED:** The LED lights green when the Power On/Off pushbutton is pressed to apply power to the JSIR900B. In addition, the LED will light red to alert the user that the batteries are nearly discharged. This condition may cause degraded performance of the JSIR900B.
6. **Power On/Off Switch:** When pressed, applies power to the Boom Box; the power on LED indicator (5) lights green.
7. **EJECT Button:** Press this button to release the spring-loaded cover to install and remove the Receiver from the JSIR900B cradle.

-5-

128-7369

5 of 12

1. Battery Installation

Your Boom Box can operate independently of AC power by installing 8 D-Cell batteries as follows:

NOTE: The batteries are bypassed automatically whenever the supplied AC Adapter is plugged into the DC 12V jack on the back panel.

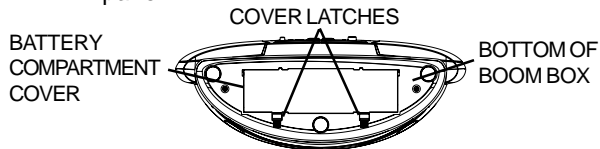

1. Turn the Boom Box upside down to access the battery compartment.
2. Push the battery cover latches forward and flip up the battery compartment cover to the open position.
3. Insert eight (8) D-Cell batteries observing battery polarity as shown; then close the cover.

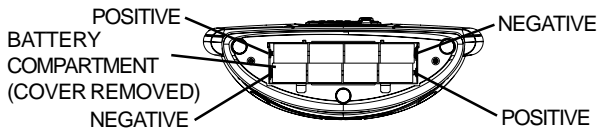

2. Cabling Interconnections

You can begin to enjoy Sirius® Satellite Radio as soon as the Receiver and Boom Box Kit installation are complete. Set up your Jensen JSIR900B by following the interconnect diagram.

3. Installing the Receiver in the JSIR900B

Install the Receiver as follows:

1. Press the EJECT button at the top of the JSIR900B to open the spring-loaded cover. Carefully line up the Receiver rear spine grooves with the Boom Box guide spines; lower the Receiver into the Boom Box.

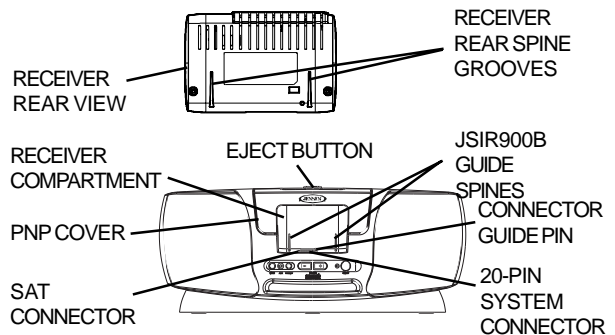

2. After making sure the connectors are properly lined up, gently press down on the Receiver to mate the connectors together. The Receiver should now be nestled securely in the Boom Box compartment. Lower the JSIR900B cover into position over the Receiver; This will prevent accidental Receiver disconnect. Apply power to the JSIR900B by pressing the Power ON/OFF button; the LED indicator lights green. If the Receiver does not turn on at the same time, press the red Power On/Off button in the upper left corner of the Receiver front panel.

4. Removing the Receiver From the JSIR900B

Press the EJECT button on top of the Boom Box to raise the cover. Gently grasp the Receiver from the top and pull straight up to disengage.

5. Installing/Positioning the Antenna

For best reception, the supplied antenna should be placed near a window if in the house or, if outdoors, in an open area and as high as possible; some repositioning may be required to achieve optimum results. The following guidelines are recommended:

Interconnect Diagram

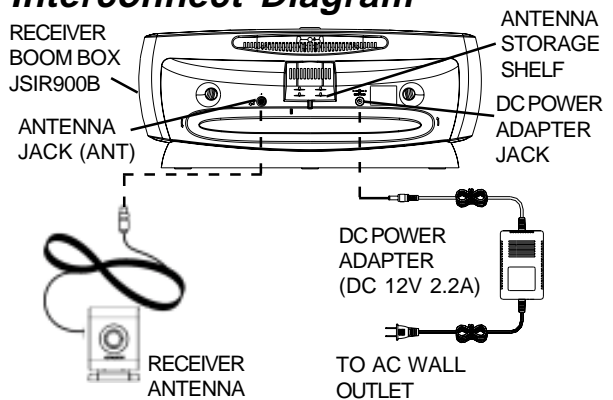

- a. In a major city, where Sirius ground repeaters are present, you can usually place the antenna away from a window and still achieve the desired results.
- b. You can also place the antenna outside (on the roof structure), provided it is clear of any overhead obstructions. Because of the orbiting characteristics of the Sirius Satellites, the strength of the received signal may change over

time. In most cases however, the signal should be available continuously. If you experience a loss of signal or audio, reposition the antenna inside the home or outside as necessary.

6. Antenna Placement Considerations

The antenna should be placed on a relatively flat surface whenever possible. When outdoors, the antenna may be left in its mount atop the Boom Box provided no overhead obstructions are present. To mount the antenna:

- a. Plug the antenna into the ANT connector on the back of the JSIR900B.
- b. Leave the antenna in place on the Boom Box, or remove the antenna from its mount, uncoil the antenna lead, and place it at the preferred location inside or outside the home. If no audio is heard, move the antenna to different positions on the surface until an audio output is heard. This is the desired antenna position and, if indoors, should be marked.
- c. After determining the optimum position, turn off JSIR900B and Receiver power. Disconnect the power adapter from the wall outlet receptacle (if indoors) and disconnect the antenna cable.
- d. Plan the routing of the antenna cable to the JSIR900B ANT input when indoors. Make sure you avoid any obstructions that could crimp, kink or twist the cable; use protective grommets wherever rough openings are encountered. If the antenna is mounted outside, route the cable from the antenna position to the interior of the home, working the cable through the basement, under a window sill, etc.; make adjustments and take up slack whenever necessary.
- e. If outdoors, either leave the antenna in place atop the JSIR900B, or remove the antenna and find a location free from overhead obstructions such as tree branches, or the roof of a tent or other temporary shelter.
- f. Plug the antenna cable into the ANT connector on the back of the JSIR900B.
- g. If not using battery power as the primary power source, plug the female end of the DC adapter cable into the DC 12V receptacle on the rear of the JSIR900B.
- h. Plug the other end of the DC adapter cable into a 110-volt receptacle. Apply power to the Boom Box and Receiver.
- i. You are now ready to enjoy Sirius programming outdoors or within your home.

-8-

128-7369

8 of 12

Specifications

Nominal Output Power per Channel	5.0 Watts Rms
Total Harmonic Distortion (THD)	0.3% at 1 Watt
Frequency Response	30Hz to 20kHz
Signal-to-Noise Ratio	>65dB Maximum
Speaker Impedance	8 Ohms Nominal
Headphone Output Impedance	32 Ohms
Headphone Output Level	500 mV (Maximum)
Headphone Connector Type	3.5 mm Stereo Jack
Auxiliary Input Impedance	6K-Ohms Nominal
Auxiliary Input Level	2.0 Volts (Maximum)
Auxiliary Connector Type	3.5 mm Stereo Jack
Equalizer Frequency	-6dB Nominal at 2.5kHz
Overall JSIR900B Dimensions	19" W x 7.18" D x 7.8" H 485 mmW x 182 mmD x 198 mmH
Overall AC Adapter Dimensions	3.5" L x 1.3" H x 2.36" W 90mmL x 33.5mmH x 60mmW
JSIR900B Weight	5.88 Lbs. (2670 Grams)

-9-

128-7369

9 of 12

Maintenance

Periodic Inspection

The JSIR900B Boom Box should be inspected periodically for external damage. At least once every 30 days of use, perform the following checks:

1. Inspect the 20-pin Receiver connector for loose, bent or broken pins, misalignment, etc.; make sure the SAT connector is intact and exhibits no apparent damage.
2. Check the VOL control for freedom of motion without binding of any kind.
3. Check that the MODE pushbutton operates correctly in that it toggles between the Satellite Radio output and the AUX input.
4. Make sure the antenna connector at the rear of the unit is free from damage of any kind and that the antenna lead plug mates correctly and securely.
5. Make sure the DC 12V connector at the rear of the unit is also free from damage of any kind and that the AC Adapter plug mates correctly and securely.
6. Check the antenna for any physical damage; make sure the antenna lead is secure and not nicked or frayed.
7. Inspect the overall Boom Box case and speaker grilles for damage such as nicks, scratches punctures, etc.

Cleaning the JSIR900B Boom Box

When cleaning the Boom Box, make sure the AC Adapter is unplugged from the power source. Do not use liquid cleaners or aerosol cleaners. Use a lint-free cloth lightly dampened with water for cleaning the exterior of the Boom Box only.

Troubleshooting

FAULT	PROBABLE CAUSE	REMEDY
System does not turn on	Receiver power is set to off	Turn Receiver power on using the Receiver Power on/off button
	Batteries not installed or installed incorrectly	Install batteries observing correct polarity
JSIR-900B does not operate using batteries	As long as the AC power connector is attached to the rear panel of the JSIR900B battery operation is disabled	Remove power connector from rear panel of JSIR900B
Intermittent operation	Low battery level	Replace batteries
ANTENNA ERROR message	Satellite antenna not connected to JSIR900B rear panel	Connect satellite antenna to JSIR900B rear panel
	Receiver not firmly seated in cradle	Press firmly down on the Shuttle to ensure that the connector is firmly mated to the Boom Box connector
ACQUIRING SIGNAL message	Check for obstacles over or around antenna	Change location to eliminate nearby obstacles (bridges, etc.)
No sound from JSIR900B speakers	Headphones installed	Remove headphones
	Incorrent mode (source) selection	Press MODE pushbutton for desired audio signal (SatelliteRadio or AUX input)



AUDIOVOX®

12 MONTH LIMITED WARRANTY

AUDIOVOX CORPORATION (the Company) warrants to the original retail purchaser of this product that should this product or any part thereof, under normal use and conditions, be proven defective in material or workmanship within 12 months from the date of original purchase, such defect(s) will be repaired or replaced with new or reconditioned product (at the Company's option) without charge for parts and repair labor.

To obtain repair or replacement within the terms of this Warranty, the product is to be delivered with proof of warranty coverage (e.g. dated bill of sale), specification of defect(s), transportation prepaid, to an approved warranty station or the Company at the address shown below.

This Warranty does not extend to the elimination of externally generated static or noise, to costs incurred for installation, removal or reinstallation of the product, damage to speakers, accessories, or vehicle and home electrical systems, malfunction of satellite transmissions, repeater signal or receiver unit.

This Warranty does not apply to any product or part thereof which, in the opinion of the Company, has suffered or been damaged through alteration, improper installation, mishandling, misuse, neglect, accident, or by removal or defacement of the factory serial number/bar code label(s). THE EXTENT OF THE COMPANY'S LIABILITY UNDER THIS WARRANTY IS LIMITED TO THE REPAIR OR REPLACEMENT PROVIDED ABOVE AND, IN NO EVENT, SHALL THE COMPANY'S LIABILITY EXCEED THE PURCHASE PRICE PAID BY PURCHASER FOR THE PRODUCT.

This Warranty is in lieu of all other express warranties or liabilities. ANY IMPLIED WARRANTIES, INCLUDING ANY IMPLIED WARRANTY OF MERCHANTABILITY, SHALL BE LIMITED TO THE DURATION OF THIS WRITTEN WARRANTY. ANY ACTION FOR BREACH OF ANY WARRANTY HEREUNDER INCLUDING ANY IMPLIED WARRANTY OF MERCHANTABILITY MUST BE BROUGHT WITHIN A PERIOD OF 48 MONTHS FROM DATE OF ORIGINAL PURCHASE. IN NO CASE SHALL THE COMPANY BE LIABLE FOR ANY CONSEQUENTIAL OR INCIDENTAL DAMAGES FOR BREACH OF THIS OR ANY OTHER WARRANTY, EXPRESS OR IMPLIED, WHATSOEVER. No person or representative is authorized to assume for the Company any liability other than expressed herein in connection with the sale of this product.

Some states do not allow limitations on how long an implied warranty lasts or the exclusion or limitation of incidental or consequential damage so the above limitations or exclusions may not apply to you. This Warranty gives you specific legal rights and you may also have other rights which vary from state to state.

U.S.A. : AUDIOVOX CORPORATION, 150 MARCUS BLVD., HAUPPAUGE, NEW YORK 11788 • 1-800-645-4994

CANADA : CALL 1-800-645-4994 FOR LOCATION OF WARRANTY STATION SERVING YOUR AREA

© 2005 Audiovox Electronics Corporation

For Customer Service
Visit our Website at
www.jensen.com
Product Information, Photos,
FAQs, Owner's Manuals

128-7369

128-7369

12 of 12

Free Manuals Download Website

<http://myh66.com>

<http://usermanuals.us>

<http://www.somanuals.com>

<http://www.4manuals.cc>

<http://www.manual-lib.com>

<http://www.404manual.com>

<http://www.luxmanual.com>

<http://aubethermostatmanual.com>

Golf course search by state

<http://golfingnear.com>

Email search by domain

<http://emailbydomain.com>

Auto manuals search

<http://auto.somanuals.com>

TV manuals search

<http://tv.somanuals.com>