



# VM9324

## Operating Instructions



**HD Radio®**

Download from [Www.Somanuals.com](http://www.Somanuals.com). All Manuals Search And Download.

**160** watts peak  
40W x 4



## CONTENTS

Thank you for choosing a Jensen product. We hope you will find the instructions in this owner's manual clear and easy to follow. If you take a few minutes to look through it, you'll learn how to use all the features of your new Jensen VM9324 Mobile Multimedia Receiver for maximum enjoyment.

Features .....	1
Optional Equipment .....	3
Warnings .....	4
Anti-Theft Feature .....	5
Controls and Indicators .....	7
Remote Control .....	9
Using the TFT Monitor .....	10
Operating Instructions .....	11
iPod Voice Control .....	16
Setup Menu .....	18
Tuner Operation .....	25
DVD/VCD Video Operation .....	29
DVD/CD Audio Operation .....	37
MP3 Operation .....	41
Viewing JPEG Photos .....	46
MPEG Movie Playback .....	47
XM <sup>®</sup> Radio Operation .....	49
iPod Operation .....	54
Bluetooth Operation .....	58
Rear Camera Function .....	67
Troubleshooting .....	68
Specifications .....	72



## FEATURES

Congratulations on your purchase of the Jensen VM9324 Mobile Multimedia Receiver.

It's a good idea to read all of the instructions before beginning the installation. We recommend having your Jensen VM9324 installed by a reputable installation shop.

### **DVD**

- Aspect Ratio - Full and Normal
- Fast Forward - 2X, 4X, 8X and 20X
- Slow Motion - 2X, 4X, 8X and 20X
- Play, Pause, Stop, Next Chapter and Previous Chapter

### **CD / MP3 / WMA**

- CD-Text Compatible
- ID3 Tag Compatible
- Directory Search (MP3 / WMA Only)
- Direct Track Access via Remote Control
- Burn up to 1500 MP3 and WMA Files onto a DVD±R / RW
- Audible Forward / Reverse Track Search (CD-DA Only)
- Random, Repeat and Intro
- Play, Pause, Stop, Next Track and Previous Track

### **HD Radio™ Tuner**

- U.S.A. / Europe Frequency Spacing
- 30 Station Presets (18 FM / 12 AM)
- Auto Stereo / Mono
- Local / Distance
- Auto Store / Preview Scan

### **XM Radio Ready**

- Requires XM CNP2000UC and CNPJEN1 (Both Sold Separately)
- XM Channel Name, Artist, Song and Categories Displayed on TFT Screen

### **iPod**

- iPod via USB
- High Speed Direct Connect Interface to Access iPod Playlists, Artists, Albums and Songs. Play music and view video/photo\* files from your iPod. \*Video/photo playback requires jLink-USB iPod interface cable (sold separately).
- Power Management Charges iPod while Connected

**Chassis**

- 2.0 DIN
- 6.2" Hi-Res TFT Active Matrix
- 1,152,000 Sub Pixels (480 x 2400)
- Heat Management System - Forced Air-Cooling to Keep the Chip-Sets Operating at Nominal Temperatures

**General**

- iPod Voice Control
- Navigation Ready (NAV102)
- Bluetooth Ready (with purchase of BTM15) providing hands-free profile for safety / convenience and A2DP profile for streaming music from a PDA / PMP
- 44-Key Infrared Remote Control
- One Composite Video Output for Additional Screens
- Front Panel Audio/Video Input
- Three-Band Tone Control (Bass, Mid and Treble) with Eight Preset EQ Curves
- Front Panel A/V Aux Input for Portable Media Devices
- Front, Rear and Subwoofer Line Output
- Programmable Volume Control
- Rear Camera Input (Normal and Mirror Image View)
- Touch Screen Calibration Mode
- 2VRMS Line Output - All Channels
- Rotary Encoder Audio Control
- SWC Interface – Compatible with PAC adapter SWI-PS Steering Wheel Control Interface, sold separately

\*HD Radio™ Technology Manufactured Under License From iBiquity Digital Corporation. U.S. and Foreign Patents. HD Radio™ and the HD and HD Radio logos are proprietary trademarks of iBiquity Digital Corporation.

## OPTIONAL EQUIPMENT

- **NAV102**

The VM9324 is "navigation ready." Before accessing any navigation features, you must purchase and install the navigation module (NAV102). All installation and operating instructions will be included with the navigation module.

Once the navigation module is connected and operating properly, the NAV source mode will become active. While the navigation module is not installed, the NAV option appears gray, indicating the function is not available.

- **Satellite Radio Tuner**

See "XM<sup>®</sup> Radio Operation" on page 49.

- **BTM15**

Before you can connect to a Bluetooth enabled device, you must purchase and install the Jensen BTM15.

- **Bluetooth Phone**

See "Bluetooth Operation" on page 58.

- **Rear Camera**

The VM9324 is "camera ready." Before accessing any camera features, you must purchase and install a rear video camera. Once the rear camera is connected and operating properly, the CAMERA source mode will become active. While the camera is not installed, the CAMERA option appears gray, indicating the function is not available.

---

## **WARNINGS**

---

***WARNING! Never install this unit where operation and viewing could interfere with safe driving conditions.***

---

---

***WARNING! To reduce the risk of a traffic accident (except when using for rear view video camera) never use the video display function while driving the vehicle. This is a violation of federal law.***

---

---

***WARNING! Never disassemble or adjust the unit.***

---

---

***WARNING! To prevent injury from shock or fire, never expose this unit to moisture or water.***

---

---

***WARNING! Never use irregular discs.***

---

---

***WARNING! To prevent damage to the mechanism inside this unit, avoid impact to the TFT monitor.***

---



## ANTI-THEFT FEATURE

The VM9324 is equipped with an anti-theft feature requiring the user to enter a password upon initial power on.

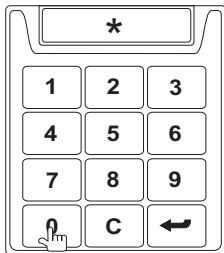

### Entering the Default Password

**The default user password is 012345** (6 digits). Enter the password using the on-screen keypad and then press the arrow (enter) button. You can also use the remote control keypad to enter the password.

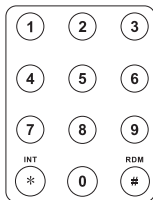

Press the  button (30) on the remote control to confirm.

## Changing the Password

To change the SECURITY password using the touch screen, perform the following steps:

1. Touch the button to view the "SETUP" menu.
2. Touch **SECURITY** to view the "SECURITY" sub-menu.

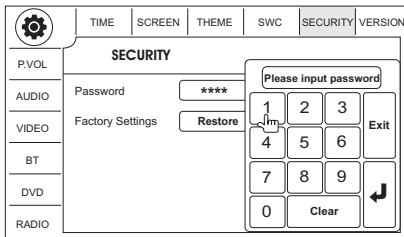

3. Enter the current password (default is 012345) and touch the arrow (enter) key.
4. Touch the "Password" field to open the on-screen keypad.
5. Enter a new 6-digit password and press the arrow (enter) button.

---

**NOTE: If you forget your password, contact Customer Service at 1-800-323-4815 for assistance.**

---

# **CONTROLS AND INDICATORS**

## **1. Rotary Encoder**

Rotate to adjust the volume. While in the audio menu, press and release to enter and/or confirm audio settings.

Press to activate the MUTE function and silence the receiver. Press again to resume sound.

## **2. SRC**

Press to turn the unit on. *Press and hold* to turn the unit off.

When on, press to view the SOURCE menu.

## **3. IR Remote Control Receiver**

## **4. USB Interface Connector**

Connect a USB device for playback of music/video files.

## **5. TFT Display**

## **6. 3.5mm A/V Input**

Attach a compatible A/V device.

## **7. DISC SLOT**

## **8. ▲ EJECT**

Press to eject a disc.

*Press and hold* to reset core mechanism position.

## **9. SD Card Slot**

Insert an SD/MMC card for playback of music/video files.

## **10. RESET**

Press to reset system settings to factory default (except the password and parental lock setting).

## **11. NAV**

When the NAV102 is connected, press to display the navigation user interface.

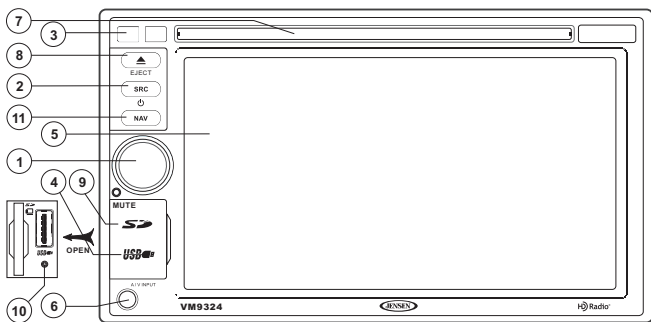

# REMOTE CONTROL

See remote control tables in various sections for button functions.

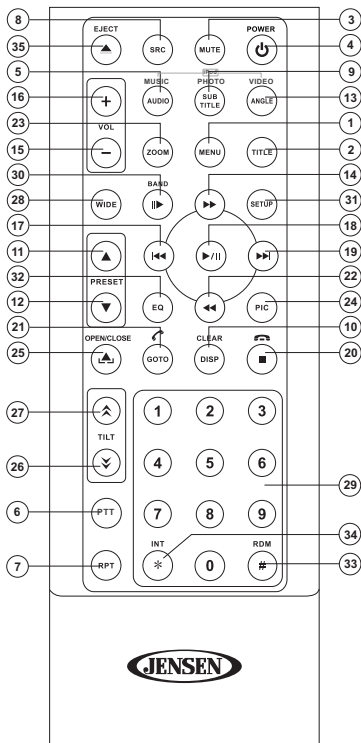

## USING THE TFT MONITOR

### Aspect Ratio

Press the **DISP** button (10) on the remote control to adjust the aspect ratio as follows:

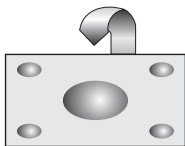

#### FULL

The entire screen is extended horizontally to the aspect ratio of 16 to 9. The extension ratio is the same at any point.

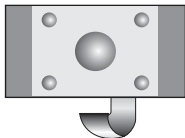

#### NORMAL

The conventional display image has a 4 to 3 ratio of horizontal to vertical, leaving a blank area on the right and left sides of the display.

#### STANDBY

Screen becomes black. Touch screen to resume.

### Parking Brake Inhibit

When the pink "Parking" wire is connected to the vehicle Parking Brake circuit, the front TFT monitor will display video when the Parking Brake is engaged. (When the pink wire is grounded via the Parking Brake circuit, video will be displayed.)

# OPERATING INSTRUCTIONS

## Power On / Off

Press the **⏻**/SRC button (2) on the unit (or the **⏻** button (4) on the remote control) to turn the unit on. The buttons on the front of the unit light up and the current mode status appears in the LCD (11).

*Press and hold* the **⏻** button to power off the unit.

## Remote Control Functions

**Table 1: Common Remote Control Functions**

<b>SRC</b>	Select playing source
<b>MUTE</b>	Toggle audio output on/off
<b>POWER/⏻</b>	Turns the power on/off
<b>VOL -</b>	Decreases volume
<b>VOL +</b>	Increases volume
<b>MENU</b>	View SOURCE menu
<b>SETUP</b>	View the system setup menu
◀ ▶  ◀◀ ▶▶	Screen navigation (does not apply to all screens/menus)
▶/	Enter command during menu navigation or Play/Pause
▲	Open/close TFT monitor
<b>1-9, 0, *, #</b>	Direct entry
<b>PIC</b>	View setup menu and touch "SCREEN" to adjust auto dimmer and backlight
<b>OPEN/CLOSE</b>	Open/close TFT monitor
<b>EQ</b>	Access equalizer menu
∨ / ∨ b	Adjust monitor angle up/down
<b>PTT</b>	Push to talk

## Mute/Line Mute

Press the rotary encoder button (1) on the front panel or the **MUTE** button (3) on the remote to mute the volume from the unit. Press the rotary encoder button again to restore the volume. "MUTE" is displayed on the LCD. Adjusting the volume or using any of the audio setup features cancels the mute function. If the "MUTE" wire is connected, audio output mutes when a telephone call is received by the car phone (using optional BTM15) or when verbal navigation is played (using optional NAV102).

## Playing Source Selection

When the monitor is closed, press the **SRC** button on the front panel (2) or remote control (8) to change between available audio playing sources in the following order: RADIO, DISC, USB/iPod, SD, BT, NAV, SAT, AUX1, AUX2 and CAMERA. The mode is displayed on the LCD screen.

### Source Menu

You can also use the touch screen to change the source through the SOURCE MENU. To access the SOURCE MENU, touch the top left corner of the screen or press the **SRC** button on the front panel (2) or remote control (8).

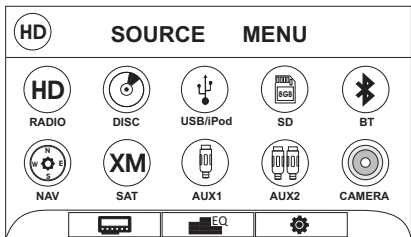

Touch the RADIO, DISC, USB/iPod, SD, BT, NAV, SAT, AUX1, AUX2 or CAMERA button to select the corresponding source.

You can also use voice control to select a source. See "iPod Voice Control" on page 16.

---

**NOTE:** When an iPod/iPhone is attached to the USB port, "IPOD" appears instead of the text "USB/iPod."

---



---

**NOTE:** You can press and hold to drag the “Source Menu” icons and rearrange them based on your preference

---

### External Devices

External peripheral devices, including a game console, camcorder, navigation unit, iPod, Zune, etc. can be connected to this unit via RCA output using the A/V Media Adapter Cable (included).

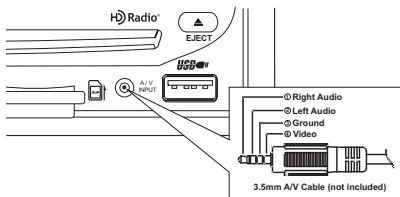

Connect the external device to the A/V Media Adapter Cable and then plug the cable into the **A/V INPUT** connector (6) on the front of the radio. Select “AUX 1” mode to access the front A/V input or “AUX 2” mode for the rear aux input. You cannot directly control external devices connected to the **A/V INPUT**. For information regarding the use of USB/SD devices, see “Inserting a USB Device” or “Accessing an SD Card” on page 42.

### Micro SD Slots (for service use only)

The micro SD slot, located in the upper right corner of the front panel, cannot be used for file playback. This input is for use by service professionals only for software updates.

## Volume Adjustment

### Volume Increase/Decrease

To increase or decrease the volume level, turn the rotary encoder (1) on the front panel or press the **VOL-/+** buttons (15, 16) on remote control. When the volume level reaches “0” or “40”, a beep sounds, indicating that the adjustment limit has been reached. The LCD or TFT screen displays the volume level for 3 seconds.

### Programmable Turn-On Volume

This feature allows the user to select a turn-on volume setting regardless of the volume setting prior to turning the unit off. To use this feature, the TFT monitor must be displayed.

To program a specific turn-on volume level, turn the rotary encoder (1) to adjust the volume to the desired turn-on volume. *Push and hold* the rotary encoder while the yellow speaker icon and level indication is displayed on the screen. The unit will beep to confirm your turn-on volume setting.

### Audio Control Menu

The Audio Control feature allows you to easily adjust your audio system to meet the acoustical characteristics of your vehicle, which vary depending on the type of vehicle and its measurements. Proper setting of the Fader and Balance boosts the effects of the cabin equalizer.

Touch the button on the screen or press the **EQ** button (32) on the remote control to display the audio menu.

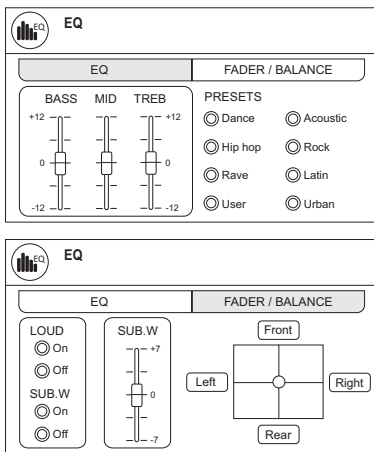

- The EQ menu appears by default. Touch "FADER / BALANCE" to view the second screen and adjust LOUD, SUB.W and FADER settings.

- Use the touch screen to adjust the settings for an audio feature.

**Table 2: Audio Adjustments**

Audio Function	Adjustable Range
EQ  (NOTE: The "User" setting is automatically selected when individual BASS, MID and TREB settings are modified.)	Dance
	Hip hop
	Rave
	User
	Acoustic
	Rock
	Latin
	Urban
BASS	-12 to +12
MID	-12 to +12
TREB (treble)	-12 to +12
SUB.W	-7 to +7
FAD	Grid
BAL	Grid

The Audio menu will automatically exit after a few seconds of inactivity. To exit quickly, touch the top left corner of the screen.

## System Reset

To correct a system halt or other illegal operation, use the tip of a pen to press the reset button (10) located on the front bottom-right corner of the unit. After a system reset, the unit restores all factory default settings.



---

**NOTE: If the unit is reset while a DVD is playing, the DVD resumes play once the reset is complete.**

---

## iPod VOICE CONTROL

You can navigate your iPod/iPhone music library and change the source/mode using the latest in voice recognition technology, allowing you to enjoy a more handsfree experience so you can focus on driving.

The VM9324 is provided with a high quality active microphone for voice control. This microphone should be mounted as close to the driver as possible, preferably on the visor directly above the driver, for best voice recognition.

---

***NOTE: Upon initial connection, depending on the number of songs and the size of iPod/iPhone storage, the index time (radio retrieving and storing song information from the iPod/iPhone for voice control access) may require a few minutes to read all the data for a large song collection. Future indexing time will be shorter, as the radio will only add to the information that has changed since the last index.***

---

Along with a predefined set of basic voice commands, the iPod voice control system can also interpret keywords to determine if you're searching for a particular song or artist.

### **Acceptable Commands**

- iPod Playback Controls
  - Play
  - Pause
  - Stop
  - Next
  - Previous
  - iPod Artist and Song Title
  - *Plus* natural speech keyword recognition
- Source/mode selection
  - Radio (HD Radio)
  - Satellite (XM Radio)
  - USB
  - iPod
  - SD
  - Bluetooth
  - DVD
  - Navigation

### **Basic Voice Operation**

1. To activate the voice control function, touch the **PTT** button on screen or on the remote control (7). The **PTT** button is located on the left side of most screens, but is not present on all screens.
2. The system displays the voice icon along with the text "Please say your command" at the top of the screen.
3. The system "listens" for a command for 5 seconds.
4. Speak a command into the microphone within 5 seconds.
  - If speech is not detected, the system displays "No speech."
  - If the speech is not recognized, the system displays "Not recognized."
  - If the speech is recognized, the system displays the command at the top of the screen and carries out the requested operation.
5. Repeat previous steps, as necessary.

---

***NOTE: While we have a very sophisticated voice recognition algorithm in the VM9324, voice commands must be spoken clearly and distinctly. Outside variables such as wind noise and conversation in the automobile may affect the radio's ability to recognize speech commands. We advise attempting voice commands with the windows closed.***

---

### **Using Natural Speech to Access your iPod/iPhone Music Library**

While in iPod/iPhone mode, you can use natural speech to access the music library. The voice control system can recognize keywords and retrieve and play the desired song or artist.

For example, you can say "I'd like to hear some Nirvana" and the system will search for Nirvana songs and play them in the order retrieved. You can even get more specific and say "How about Smells Like Teen Spirit by Nirvana" and the system will search for and play the specified song, provided the the song is present in the music library.

### **Steering Wheel Control**

The VM9324 offers the option to re-program one of your steering wheel controls to operate as the "PTT" (Push To Talk) control on the VM9324, allowing for a truly hands-free music management experience. See "SWC (Steering Wheel Control) Sub-menu Features" on page 20.

## SETUP MENU

To access system settings, touch the  button on the screen to enter the setup menu. The "TIME" sub-menu appears highlighted in yellow.

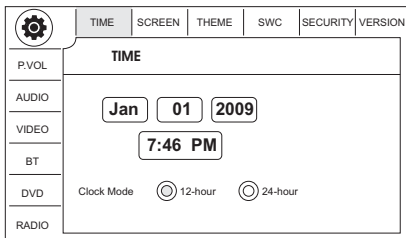

### Accessing Menu Items

Touch to select a sub-menu (Screen, Theme, SWC, etc.).

The features available for adjustment under the highlighted sub-menu option will appear in the center of the screen.

### Adjusting a Feature

1. Use the touchscreen to select the feature to be adjusted.
2. Touch to select an option for the feature you want to adjust.

### TIME Sub-menu Features

Setting	Options	Function
Clock Mode	12-hour	Clock displays 12 hour time using AM and PM.
	24-hour	Clock displays 24 hour time up to 23:59.
Month	Jan-Dec	Touch to view the direct entry keypad. Enter numeric equivalent of current month (1-12) and touch the enter key.
Day	01-31	Touch to view the direct entry keypad. Enter current day of the month (01-31) and touch the enter key.
Year	20_ _	Touch to view the direct entry keypad. Enter current year of the month (20_ _) and touch the enter key.
Hour	1-12	Touch to view the direct entry keypad. Enter current hour and touch the enter key.
Minutes	00-59	Touch to view the direct entry keypad. Enter current minutes and touch the enter key.
AM/PM	AM/PM	Touch to toggle AM/PM. Feature is not displayed when 24-hour Clock Mode is selected.

### SCREEN Sub-menu Features

Setting	Options	Function
Auto Dimmer	On	Screen automatically dims/brightens for optimal day and night viewing.
	Off	Screen remains a constant brightness.
Backlight	0-12	Touch the +/- buttons to adjust the backlight brightness level.
TS Calibration	Adjust	After entering calibration mode, a crosshair + appears in a corner quadrant of the screen. To begin calibration, press and hold the crosshair for one second until it moves to the next quadrant. Continue for each quadrant until the calibration is completed.

### THEME Sub-menu Features

Setting	Options	Function
Wallpaper	Various	Choose from 12 different background images for your SOURCE MENU.
OSD	English	English is the only available On Screen Display option.
DEMO	Run	Demo scrolls through the various source screens, simulating activity on the display. "Demo" is displayed in the top left corner of the screen, to indicate the unit is in Demo Mode. To stop Demo Mode, press the upper-left quadrant of the TFT (Source select).

### **SWC (Steering Wheel Control) Sub-menu Features**

The VM9324 is compatible with the PAC (Pacific Accessory Corporation) steering wheel control adapter SWI-PS. A 3.5mm female connector (labeled "SWC Interface") on the back of the head unit allows connectivity to the PAC adapter. Please refer to the instructions included with the PAC adapter for detailed installation information.

The SWC menu allows you to assign different functions to the SWC buttons. To change a button assignment, touch the function name and follow the instructions in the pop-up window.

The following default controls are available for most vehicles:

1. Vol Down
2. Vol Up
3. Mute
4. Seek Down / Previous Track / \*\* Preset Down
5. Seek Up / Next Track / \*\* Preset Up
6. SRC (Source)
7. \*\* Select
8. \*\* Select
9. Band

\*\* If additional steering wheel control buttons are available on the vehicle, function 7 / 8 may be assigned the "Select" feature. This feature / function may not be available on some vehicles. If "Select" (function 7 or 8) is held down and function 4 is pressed momentarily, Preset Up will be selected. If "Select" (function 7 or 8) is held down and function 5 is pressed momentarily, Preset Down will be selected.

---

***NOTE: The VM9324 offers the option to reprogram one of your steering wheel controls to operate as the "PTT" (Push To Talk) control on the VM9324 to activate voice control for a truly hands-free music management experience.***

---



### **SECURITY Sub-menu Features.**

Setting	Options	Function
Password	*****	Enter the current password (default is 012345) and touch the arrow (enter) key to access SECURITY features. To change the password, touch the "Password" field to open the on-screen keypad. Enter a new 6-digit password and press the arrow (enter) button.
Factory Settings	Restore	Select "Restore" to restore the factory default settings.

### **VERSION Sub-menu Features**

Selection the VERSION tab to view the model number and system software version information.

### **P.VOL Sub-menu Features**

Setting	Options	Function
P.Vol Page 1	DISC	Increase or decrease relative volume for the specified source up to 6 decibels.
	RADIO	
	SD	
	USB	
	iPod	
P.Vol Page 2	BT	Increase or decrease relative volume for the specified source up to 6 decibels.
	AUX1	
	AUX2	
	NAV	
	SAT	

### **AUDIO Sub-menu Features**



<b>Setting</b>	<b>Options</b>	<b>Function</b>
Loudness	On	Turn bass boost on/off
	Off	
DRC	On	Employ the Dynamic Range Control for better playback for low volumes.
	Off	
Sub-woofer	On	Turn the subwoofer on/off.
	Off	
Sub-woofer Filter	80Hz	Selecting a crossover frequency sets a cut-off frequency of the subwoofer's LPF (low-pass filter).
	120Hz	
	160Hz	

### **VIDEO Sub-menu Features**

If the rear-view video camera is connected, the unit is on, and the TFT monitor is retracted inside the unit, the TFT monitor automatically moves into the viewing position and Camera mode is selected upon shifting into REVERSE gear. When shifting into DRIVE gear, the TFT monitor is retracted back inside unit.

<b>Setting</b>	<b>Options</b>	<b>Function</b>
Camera In	Normal	Display camera image as captured.
	Mirror	Reverse the camera image as if looking through a rear-view mirror.
	Off	Disable rear camera function.
Video Input	Auto	Input circuitry automatically detects the video signal from the Aux In source. The color signal output is switched automatically based on the current video input signal to NTSC or PAL.

### BT (Bluetooth) Sub-menu Features

Setting	Options	Function
Bluetooth	On	Enable Bluetooth function.
	Off	Disable Bluetooth function.
Auto Answer	On	The unit automatically answers all incoming calls.
	Off	Manually answer calls by touching the  button.
Auto Connect	On	Automatically connect when your paired phone is in range.
	Off	Connect the last active mobile phone by touching the  icon when disconnected.
Pairing Code	****	The default code is "1234". Touch the keypad icon to open the keypad and enter the pairing code or pass key required for Bluetooth connection to your mobile phone. Not all phones/devices require a pairing code. The default code is "0000" for many models.

### DVD Sub-menu Features

If a DVD supports more than 1 Subtitle or Audio language, all the languages are available for selection during playback. If the selected language is not supported by the DVD, then the default language is used.

Setting	Options	Function
Audio	English	DVD Audio is heard in English when the option is available.
Subtitle	English	DVD subtitles automatically appear in English when available.
DVD Menu	English	DVD menu (if applicable) is displayed in English.
Parental Ctrl	****	Enter a 4-digit password to activate the "Rating" feature.
	1. Kid Safe	Select the appropriate rating level for the intended audience.
	2. G	Once the rating feature is activated, you will need to enter the 4-digit code to override the block on programs rated higher than the selected rating level. For full access to programming choose the "Adult" rating level.
	3. PG	
	4. PG-13	
	5. PG-R	
	6. R	<i>NOTE: After entering a correct password in the locked field, you can use any 4-digit password to re-lock the field. The password can be changed each time or you can reuse a previous password.</i>
	7. NC-17	
8. Adult		

**NOTE: Record the password and keep it in a safe place for future reference. The rating for each disc is marked on the disc, disc packing, or documentation. If the rating is not available on the disc, the parental lock feature is unavailable. Some discs restrict only portions of the disc and the appropriate content will play. For details, please refer to the disc description.**

### **RADIO Sub-menu Features**

<b>Setting</b>	<b>Options</b>	<b>Function</b>
Tuner Area	U.S.A.	<ul style="list-style-type: none"> <li>• AM Frequency Spacing - 10kHz</li> <li>• AM Frequency Band - 530kHz~1720kHz</li> <li>• FM Frequency Spacing - 200kHz</li> <li>• FM Frequency Band - 87.5MHz~107.9MHz</li> </ul>
	Europe	<ul style="list-style-type: none"> <li>• AM Frequency Spacing - 9kHz</li> <li>• AM Frequency Band - 522kHz~1620kHz</li> <li>• FM Frequency Spacing - 50kHz</li> <li>• FM Frequency Band - 87.5MHz~108.0MHz</li> </ul>

### **Exiting the System Setup Menu**

To exit setup mode and resume normal playback, touch the  button in the top left corner of the screen.

## TUNER OPERATION

To access the radio (HD) screen, press the **SRC** button (2) on the front panel or remote control (8) or touch the top left corner of the screen to access the Source menu, and then touch the "RADIO" icon. With the screen closed, press the **SRC** button (8) on the remote control until "RADIO" appears on the LCD. The on-screen indicators and touch key areas for radio mode are outlined below.

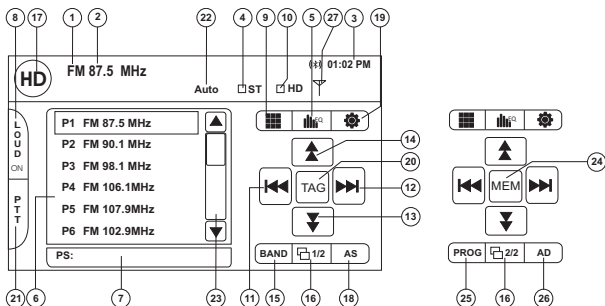









### Indicators/Controls

1. Current radio band indicator
2. Radio frequency indicator
3. Clock
4. Stereo broadcasting indicator
5. : Equalizer adjustment screen
6. Recall preset stations
7. Information about the current function
8. **LOUD**: Turn the Loudness function ON/OFF
9. : Access the direct entry screen
10. HD signal broadcasting indicator
11. : Seek tuning lower
12. : Seek tuning higher
13. : Incremental tuning lower
14. : Incremental tuning higher
15. **BAND**: Change between AM/FM bands
16. **1/2**: View a second screen of menu choices

17. (a) Current source  
(b) Touch to view the SOURCE MENU and select a new source
18. **AS**: Scan and automatically store strongest received stations
19. : View the SETUP menu
20. **TAG**: Tag the current song for possible iTunes download. If an iPod is connected, the tag goes directly to the iPod/iPhone. If no iPod is connected, the unit stores the tag (up to 64) for transfer to the iPod later.
21. **PTT**: Activate the Push To Talk voice recognition feature. See "iPod Voice Control" on page 16.
22. Analog/Digital/Auto signal tuning indicator
23. Touch the arrows and scroll bar to navigate the list
24. **MEM**: View screen used to enter current channel into preset memory
25. **PROG**: Activate choose a program type for tuning
26. **A/D**: Choose between Analog, Digital and Auto tuning modes
27. Signal strength indicator

## Remote Control Functions

**Table 3: Tuner Remote Control Functions**

	Select AM/FM band
	Seek tuning lower
	Seek tuning higher
	Incremental tuning lower
	Incremental tuning higher
	Confirm (enter) direct entry
<b>PRESET</b>  / 	Navigate preset station list
<b>1-9, 0, *, #</b>	Direct entry
<b>EQ</b>	Access equalizer menu
<b>GOTO</b>	Access direct entry keypad
<b>PTT</b>	Push to talk
<b>TAG</b>	Tag the current song for possible iTunes download

## Direct Tuning

To enter a radio station directly, touch the  button or press the **GOTO** button (21) on the remote control to display the direct entry menu.

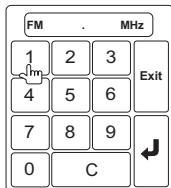

Enter the desired radio station using the on-screen number pad. Press the arrow (enter) button to tune to the selected station. To exit the screen without changing the station, touch **Exit**. To clear your entry and start over, touch **Clear**.

## Using Preset Stations

Eighteen numbered preset buttons store and recall stations for the AM and FM band. All eighteen stored stations (P1-P18) for the current band appear on the screen for immediate recall.

### Storing a Station

1. Select a band (if needed), then select a station.
2. Touch the on-screen **MEM** button (24) on page 2/2 to open the preset screen.

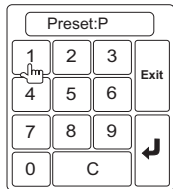

3. Touch to enter the preset number in which you would like to store the current station (or touch **Exit** to cancel and close the menu). The preset number and station appears highlighted in the list.

### Recalling a Station

1. Select a band (if needed).
2. Touch an on-screen preset button (6) to select the corresponding stored station.

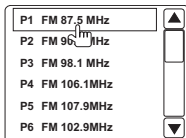

### Auto Store (AS)

To select 18 strong stations and store them in the current band:

1. Select a band (if needed).
2. Touch the **AS** button (18) on page 1/2 of the on-screen controls to activate the Auto Store function.

The new stations replace stations already stored in that band.



---

## DVD/VCD VIDEO OPERATION

---

**NOTE:** When properly installed, DVD video cannot be displayed on the main TFT screen unless the parking brake is applied. If you attempt to play a DVD while the vehicle is moving, the TFT screen displays "WARNING!!! It is illegal to view video while driving or operating a motor vehicle, Set parking brake to view video." Rear video screens, if applicable, will operate normally.

---

### Inserting a Disc

Upon inserting a DVD disc in the disc slot (7), DVD mode is entered and disc play begins.

---

**NOTE:** If Parental Lock (Rating) is activated and the disc inserted is not authorized, the 4-digit code must be entered and/or the disc must be authorized (see "VIDEO Sub-menu Features" on page 22).

---

You cannot insert a disc if there is already a disc in the unit or if the power is off.

---

**NOTE:** DVD-R and DVD-RW will not play unless the recording session is finalized and the DVD is closed.

---

### Ejecting a Disc

Press the ▲ button (8) on the unit or remote control (35) to eject the disc. The unit automatically reverts to Tuner mode. You may eject a disc with the unit powered off. The unit will remain off after the disc is ejected.

### Resetting the Loading Mechanism

If the disc loads abnormally or an abnormal core mechanism operation occurs, press and hold the ▲ button (8) on the unit or remote control (35) to reset the loading mechanism. Normal operation resumes.

## Accessing DVD Mode

To switch to DVD mode when a disc is already inserted, press the **SRC** button (2) on the front panel or remote control (8) to access the SOURCE MENU.

Touch the "DISC" icon.

**Table 4: DVD/VCD Remote Control Functions**

Button	Function	
	DVD	VCD
<b>MENU</b>	Access DVD menu.	Turns on/off PBC when playing VCD
<b>TITLE</b>	Enter the title menu of the disc	
<b>AUDIO</b>	Select alternate audio language	Select Left Channel, Right Channel, Mix or and Stereo output
<b>RPT</b>	(x1) Repeat Chapter, (x2) Repeat Title, (x3) Repeat Off	(x1) Repeat Single (x2) Repeat All (x3) Repeat Off (with PBC Off)
■	Stop playback	Stop playback
▶/	Resume playback Select option on DVD menu	Resume playback Select option on DVD menu
◀◀	Play previous chapter Navigate on-screen menu left	Play previous chapter Navigate on-screen menu left
▶▶	Play next chapter Navigate on-screen menu right	Play next chapter Navigate on-screen menu right
◀◀	Fast reverse (x2 → x4 → x8 → x20 → Play)	Fast reverse (x2 → x4 → x8 → x20 → Play)
▶▶	Fast forward (x2 → x4 → x8 → x20 → Play)	Fast forward (x2 → x4 → x8 → x20 → Play)
<b>ZOOM</b>	Zoom picture (+1 → +2 → +3 → OFF)	Zoom picture (+1 → +2 → +3 → OFF)
<b>DISP</b>	View on-screen playback information	View on-screen playback information
<b>1-9, 0</b> (Keypad)	Enter digits for direct entry	Enter digits for direct entry
<b>GOTO</b>	Access direct entry screen	Access direct entry screen
<b>SUBTITLE</b>	Select subtitle language	
<b>ANGLE</b>	Play alternate angles if DVD contains scenes shot simultaneously from different angles	

## Controlling Playback

To access the on-screen controls, touch the bottom 1/3 of the screen while a DVD is playing. Touch the **1/2** button to view a second page of controls

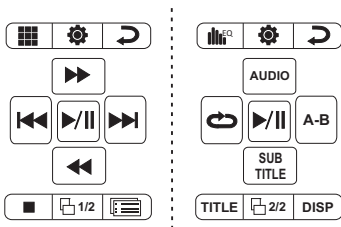

### Stopping Playback

Touch the stop button (■) on the screen or press the **||▶/BAND** button (20) on the remote control to stop DVD play.

### Pausing Playback

Touch the play/pause button (▶) on the screen or press the **▶/||** button on the remote control (18) to suspend or resume disc play.

### Slow Motion Playback

Press the **◀◀** button (22) on the remote control or the **◀◀** button on the screen to play the current title in slow motion. Keep pressing and releasing the button to increase the rate from “x2” to “x4”, “x8”, and “x20”.

Press **▶/||** (16) on the remote control or touch the on-screen play button (▶) to resume normal play.

### Fast Forward Playback

Press the **▶▶** button (14) on the remote control or the **▶▶** button on the screen to fast forward. Keep pressing and releasing the button to increase the rate from “x2” to “x4”, “x8”, and “x20”.

Press **▶/||** (18) on the remote control or touch the on-screen play button (▶) to resume normal play.

### Repeat Playback

Press the **RPT** button (7) on the remote control or the **↺** button on screen to alter repeat mode according to the following:

Download from [Www.Somanuals.com](http://www.Somanuals.com). All Manuals Search And Download.

- DVD: Repeat Chapter, Repeat Title, Repeat Off
- VCD (PBC Off): Repeat Single, Repeat Off

---

**NOTE: For VCD play, the repeat function is not available if PBC is on.**

---

### Sectional Repeat Function (A-B)

Use the A-B function to define a specific area of a disc to repeat.

- Press the **A-B** button on screen to set the start point (A) of the repeated section.
- Press the **A-B** button again once you reach the desired end point (B) of the repeated section. The selected portion of the DVD will now repeat continuously.
- Press the **A-B** button again to cancel the A-B section setting and stop repeat play.

### Accessing the DVD Menu

Press the **MENU** button (1) on the remote control to recall the main DVD menu. Use the directional (arrow) buttons on the remote control to select a title from the menu or touch the title on screen.

Press the **TITLE** button (2) on the remote control or on screen to select a different title for playback.

Press the **▶/||** button (18) on the remote control or press the rotary encoder (1) to confirm your selection and begin playback. You can also select a title using the touch screen.

### Moving Through Chapters

Press the **▶▶|** button (19) on the remote control or the **▶▶|** button on screen to advance to the next chapter on the DVD.

Press the **|◀◀** button (17) on the remote control or the **|◀◀** button on screen to move to the previous chapter.

### Goto Search (Remote Control Required)

During DVD or VCD playback, perform the following steps to use the GOTO feature to access a specific location on a disc:

1. Press the **GOTO** button (21) on remote control to access the "Search" screen.
2. Press the **▶▶** or **◀◀** buttons (14, 22) on the remote control to select a category (highlighted in yellow).

- For DVD mode, you can choose Time or Title/Chapter search.

Search	
Title	<input type="text" value="20"/>
Chapter	5
Time	00 : 00 : 00

#### DVD Search

**Title** – Go to specific title

**Chapter** – Go to specific chapter

**Time** – Go to specific time in current title

- For VCD mode, press the **GOTO** button to choose between Time search.

Search	
Time	<input type="text" value="00 : 00 : 00"/>

#### VCD Track Search

**Time** – Go to specific time in the current track

- Enter a time into the field using the numeric keypad (29) on the remote control.
- Press the **▶/||** button (18) on the remote control to go to the specified location on the disc.
- Press the **GOTO** button again to exit.

## Direct Chapter / Track Selection

### Remote Control Direct Entry

During DVD, VCD and CD playback, you can use the numeric keypad on the remote control (29) to access a track directly.

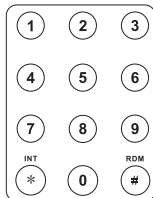

### ***Touch Screen Direct Entry***

To select a chapter/track directly, touch the  button on screen control to display the direct entry menu.

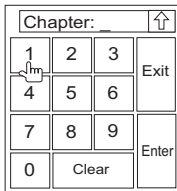

Enter the desired chapter/track using the on-screen number pad. Press the **Enter** button to tune to the selected station. To exit the screen without changing the station, touch **Exit**. To clear your entry and start over, touch **Clear**.

### **Viewing an Alternate Picture Angle (DVD Only)**

Some DVDs contain scenes that have been shot simultaneously from different angles. For discs recorded with multiple angles, press the **ANGLE** button (13) on the remote control to toggle available angles of the on-screen image.

### **Zooming**

Press the **ZOOM** button (23) on the remote control to enlarge and pan through the video image using the following options: "Q1", "Q2", "Q3" and "OFF".

### **Multi-Language Discs (DVD Only)**

#### ***Changing Audio Language***

If you are watching a disc recorded in multiple languages, press the **AUDIO** button (5) on the remote control to choose a language.

#### ***Changing Subtitle Language***

If you are watching a disc recorded in multiple languages with subtitles, press the **SUBTITLE** button (9) on the remote control to choose the language in which you would like the subtitles to appear.

---

**NOTE:** During VCD playback, press the **AUDIO** button (5) on the remote control to choose between Left Channel, Right Channel, and Stereo.

---

## **PBC - Play Back Control (VCD Only)**

For VCDs with play back functionality, play back control (PBC) provides additional controls for VCD playback.

Press the **MENU** button (1) on the remote control to toggle the PBC function "On"/"Off". Once PBC is on, playback starts from track one of the play list.

---

**NOTE:** When PBC is activated, fast forward, slow playback, and previous/next track are available. Repeat and direct track selection are not available.

---

When PBC is activated, selecting random, scan, or search playback automatically deactivates PBC.

## **Playback Information**

During DVD and VCD playback, press the **DISP** button (10) on the remote control to display playback information on the screen, including the media playing and current playback time.

### **DVD Playback Information**

- DVD Video – Format of current disc.
- Time 00:01:30/00:36:10 – Indicates the playback time of the current track.
- Title 5/08 – Indicates the fifth of 8 titles on the DVD is currently playing.
- Chapter 2/16 – Indicates that the second of 16 titles on the DVD is currently playing.

### **VCD Playback Information**

- VCD2.0 – Format of current disc.
- Time 00:01:30/00:36:10 – Indicates the playback time of the current track.
- PBC On/Off – Indicates whether Play Back Control is On or Off.

## General Disc Information

**Table 5: Disc Properties**

Symbol	12cm Disc Properties	Max Play Time
	Single side single layer (DVD-5) Single side double layer (DVD-9) Double side single layer (DVD-10) Double side double layer (DVD-18)	(MPEG 2 Method) 133 minutes 242 minutes 266 minutes 484 minutes
	Single side single layer (VCD)	(MPEG 1 Method) 74 minutes
	Single side single layer	74 minutes

**Table 6: Disc Symbols**

Symbol	Meaning
	Number of voice languages recorded. The number inside the icon indicates the number languages on the disc (maximum of 8).
	Number of subtitle languages available on the disc (maximum of 32).
	Number of angles provided (maximum of 9).
	Aspect ratios available. "LB" stands for Letter Box and "PS" stands for Pan/Scan. In the example on the left, the 16:9 video can be converted to Letter Box video.
	Indicates the region code where the disc can be played. <ul style="list-style-type: none"> <li>• Region 1: USA, Canada, East Pacific Ocean Islands</li> <li>• Region 2: Japan, Western Europe, Northern Europe, Egypt, South Africa, Middle East</li> <li>• Region 3: Taiwan, Hong Kong, South Korea, Thailand, Indonesia, South-East Asia</li> <li>• Region 4: Australia, New Zealand, Middle and South America, South Pacific Ocean Islands/Oceania</li> <li>• Region 5: Russia, Mongolia, India, Middle Asia, Eastern Europe, North Korea, North Africa, North-West Asia</li> <li>• Region 6: Mainland China</li> <li>• ALL: All regions</li> </ul>



## DVD/CD AUDIO OPERATION

Instructions for TFT control and Insert/Eject are the same for DVD and CD operation. Please see the DVD/Disc Video Operation section for information about these topics.

The VM9324 will play music or other audio files from the following disc media:

- CD-DA
- CD-R/RW
- DVD
- DVD+R/RW
- DVD-R/RW

---

**NOTE: CD-R and CD-RW will not play unless the recording session is finalized.**

---

### Accessing DISC Mode







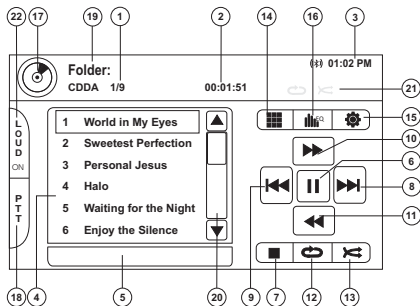





To access the DISC screen, press the **SRC** button (2) on the front panel or touch the top left corner of the screen to access the Source Menu, and then touch the "DISC" icon. When the screen is closed, press the **SRC** button (8) on the remote control until the "DISC" is displayed on the LCD.

### On-Screen Controls and Indicators

The on-screen indicators and touch key areas for CD/DVD audio playback are outlined below:











1. Current track and total number of tracks on disc

2. Elapsed playing time
3. Current time
4. Track titles
5. Disc title
6. : Play/pause
7. : Stop disc playback. Press  to resume normal playback.
8. : Previous track
9. : Next track
10. : Fast reverse x2, x4, x8, x20. Press  to resume normal playback.
11. : Fast forward x2, x4, x8, x20. Press  to resume normal playback.
12. : Repeat  
 CDDA: (x1) Repeat Single, (x2) Repeat Folder, (x3) Repeat Off  
 DVD: (x1) Repeat Chapter, (x2) Repeat Title, (x3) Repeat Off  
 CD-R/RW: (x1) Repeat Single, (x2) Repeat Off  
 DVD-R/RW: (x1) Repeat Single, (x2) Repeat Off
13. : Activate/deactivate Random mode
14. : Access the direct entry screen
15. : View the SETUP menu
16. Touch for quick access to Equalizer level settings
17. (a) Current source  
 (b) Touch to view the SOURCE MENU and select a new source
18. **PTT**: Activate the Push To Talk voice recognition feature. See “**iPod** Voice Control” on page 16.
19. Folder name
20. Touch the arrows and scroll bar to navigate the list
21. Repeat and Random playback indicators
22. **LOUD**: Turn loudness features ON/OFF

## Remote Control Functions

**Table 7: CD/DVD Audio Remote Control Functions**

	Eject disc
 <b>BAND</b>	Select AM/FM band
	Previous track
	Next track
	Fast reverse x2, x4, x8, x20
	Fast forward x2, x4, x8, x20
	Play/pause
	Stop playback
<b>1-9, 0</b>	Direct entry
<b>EQ</b>	Access equalizer menu
<b>GOTO</b>	Access direct entry keypad
<b>PTT</b>	Push to talk
<b>RPT</b>	CDDA: (x1) Repeat Single, (x2) Repeat Folder, (x3) Repeat Off DVD: (x1) Repeat Chapter, (x2) Repeat Title, (x3) Repeat Off CD-R/RW: (x1) Repeat Single, (x2) Repeat Off DVD-R/RW: (x1) Repeat Single, (x2) Repeat Off
<b>#/RDM</b>	Turn random (shuffle) mode on/off

### Track Scan Select (CD-DA discs only)

During disc play, press the **INT** button (34) on the remote control to play the first 10 seconds of each track. When a desired track is reached, press the **INT** button again to cancel the function and play the selected track.

## Direct Track Entry

To select a track directly, touch the  button on screen control to display the direct entry menu.

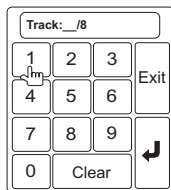

Enter the desired track using the on-screen number pad. Press the enter button (arrow) to play the selected track. To exit the screen without selecting a track, touch **Exit**. To clear your entry and start over, touch **Clear**.

## MP3 OPERATION

Instructions for TFT control and Insert/Eject are the same for DVD and MP3 operation. Please see the DVD/Disc Video Operation section for information about these topics.

### Media and File Requirements

This player allows you to play back MP3 and WMA files recorded onto CD-R/RWs, DVD+R/RWs, and DVD-R/RWs. For CD-RW discs, please make sure it is formatted using the full method and not the quick method to prevent illegal disc operation.

---

***NOTE: CD-R and CD-RW will not play unless the recording session is finalized.***

---

Up to 1500 songs/files can be burned onto a disc for a DVD music mix. Do not exceed this number of songs/files or disc readability problems may occur.

#### ***MP3 Format Compatibility***

The file naming formats listed below are compatible with this unit:

- ISO 9660 – file name: 12 characters, file extension: 3 characters
- ISO 9660 – file name: 31 characters, file extension: 3 characters
- Joliet – 64 characters

If the file or folder name does not conform to ISO 9660 file system standards, it may not be displayed or played back correctly. Use the following settings when compressing audio data for your MP3 disc:

- Transfer Bit Rate: 128kbps
- Sampling Frequency: 48kHz

When recording MP3 up to the maximum disc capacity, disable additional writing. For recording on an empty disc up to maximum disc capacity, use the "Disc at once" setting.

#### ***MP3 Playing Order***

When selected for play, files and folders (Folder Search, File Search or Folder Select) are accessed in the order they were written by the CD writer. As a result, the order in which they are expected to be played may not match the order in which they are actually played. You may be able to set the order in which MP3/WMA files are to be played by writing them onto a medium such as a CD-R with their file names beginning with play sequence numbers such as "01" to "99".

For example, a medium with the following folder/file hierarchy is subject to Folder Search, File Search or Folder Select, as shown below.

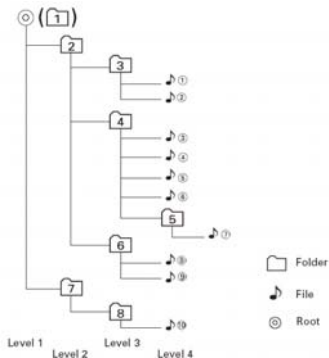

The VM9324 player will only recognize three folder levels and does not display folders containing only other folders. In the example above, the unit will display folders 3, 4, 6, and 8, but not 2 and 7 since they do not contain any tracks directly. Folder 5 is not recognized at all since it is at the fourth level.

## Inserting a USB Device

**NOTE: The USB port will recognize most USB flash memory devices and portable hard drives (hard drives must be formatted to FAT32, NTFS is not supported).**

1. Locate the USB connector (4) on the front of the radio.

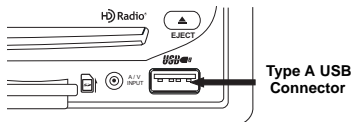

2. Insert the USB device into the USB connector. The unit will read the audio/video files on the USB device automatically.

To remove the USB device, press the **SRC** button (2) to switch to another mode and then remove the USB device from the USB connector.

Download from [Www.Somanuals.com](http://www.Somanuals.com). All Manuals Search And Download.

## Accessing an SD Card

1. Locate the SD connector (9) on the front of the radio.
2. Insert the SD card into the SD connector.
3. Press the **SRC** button (2) on the front panel or remote control (8) or touch the top left corner of the screen to access the Source menu, and then touch the "SD" icon.

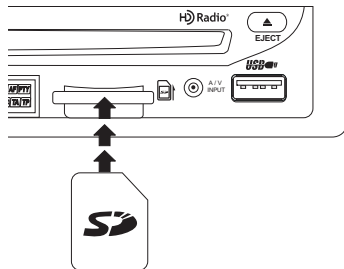

Before removing the SD card, change the radio to another source. To remove, pull straight out.

---

**NOTE: Maximum SD card size supported by this unit is 16GB.**

---

## Accessing MP3 Mode

To access the MP3 interface screen, press the **SRC** button (2) on the front panel or touch the top left corner of the screen to access the Source Menu, and then touch the source containing MP3 files. When the screen is closed, press the **SRC** button (8) on the remote control until the appropriate source name is displayed on the LCD. MP3/WMA files will play in the sequence of the 'Root' directory.

---

**NOTE: When burning MP3 / WMA files onto a DVD disc, use the 2X or 4X burning option, if available. This slower burning speed will help eliminate buffer errors and increase disc reading reliability. Also, use folders when burning large numbers of songs / files to a disc for easy music navigation. Select the "Disc at Once" option and close your disc.**

---



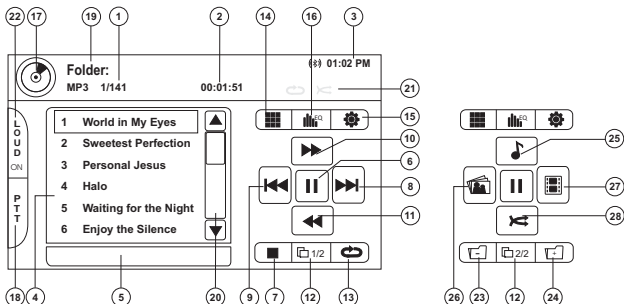

## On-Screen Controls and Indicators

The on-screen indicators and touch key areas for MP3 playback are outlined below.









1. Current track and total number of tracks on disc
2. Elapsed playing time
3. Current time
4. Track titles
5. ID3 information
6. ▶||: Play/pause
7. ■: Stop disc playback. Press ▶|| to resume normal playback.
8. |◀◀: Previous track
9. ▶▶: Next track
10. ◀◀: Fast reverse x2, x4, x8, x20. Press ▶|| to resume normal playback.
11. ▶▶: Fast forward x2, x4, x8, x20. Press ▶|| to resume normal playback.
12. 1/2, 2/2: Touch to move between page 1 and 2 of the on-screen controls
13. ↻: (x1) Repeat Single, (x2) Repeat Folder, (x3) Repeat Off
14. ■■: Access the direct entry screen.
15. ⚙: View the SETUP menu.
16. Touch for quick access to Equalizer level settings.
17. (a) Current source  
(b) Touch to view the SOURCE MENU and select a new source
18. PTT: Activate the Push To Talk voice recognition feature. See "iPod Voice Control" on page 16.
19. Folder name
20. Touch the arrows and scroll bar to navigate the list.



21. Repeat and Random playback indicators
22. **LOUD**: Turn loudness features ON/OFF
23. **DIR -**: View the previous folder
24. **DIR +**: View the next folder
25. : List audio files
26. : List photo files (see "Viewing JPEG Photos" on page 46)
27. : List video files (see
28. : Activate/deactivate Random mode

## Remote Control Functions

**Table 8: MP3 Remote Control Functions**

	Eject disc
	Previous track
	Next track
	Fast reverse x2, x4, x8, x20
	Fast forward x2, x4, x8, x20
	Play/pause
	Stop playback
<b>1-9, 0</b>	Direct entry
<b>EQ</b>	Access equalizer menu
<b>GOTO</b>	Access direct entry keypad
<b>PTT</b>	Push to talk
<b>RPT</b>	(x1) Repeat Single, (x2) Repeat Folder, (x3) Repeat Off
<b>#/RDM</b>	Turn random (shuffle) mode on/off

## Direct Track Entry

Use the numeric keypad (29) on the remote control to access files directly or press the  button (see "Direct Track Entry" on page 40).

## VIEWING JPEG PHOTOS

JPEG images stored as individual images or stored in folders can be accessed using the DISC/SD/USB interface. When a disc/card is loaded and read by the unit, the root menu will display the music contents of the disc when music files are present. To view photos, press the button to view a second page of controls and then press the button.

### Controlling Playback

Touch the arrows and scroll bar to the right of the image names to navigate the list. Touch the image name to display the selected image. The unit will display the selected image and then automatically play a slide show of all images.

While viewing photos, touch the bottom half of the screen to access the following on-screen controls:

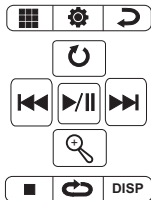

- : Access the direct entry screen
- : View the SETUP menu
- : Close on-screen menu
- : Rotate clockwise in 90 degree increments
- : Previous photo
- : Play/pause
- : Next photo
- : Zoom Q1, Q2, Q3, QOff
- : Stop photo slide show and return to the USB menu
- : (x1) Repeat Single, (x2) Repeat Folder, (x3) Repeat Off
- DISP**: Display file information (file name and track number)



### Returning to the Music Interface

To return to the music interface, touch the icon to list audio files. Touch to select an audio file and begin playback. Touch the button to view MP3 playback controls.

## MPEG MOVIE PLAYBACK









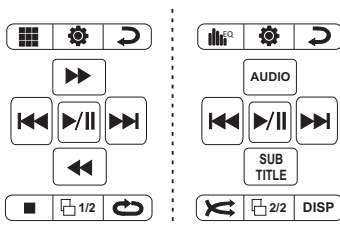





Version 1 and 2 MPEG movies can be accessed using the DISC/SD/USB interface. When a disc/card is loaded and read by the unit, the root menu will display the music contents of the disc when music files are present. To view MPEG movies, press the  button to view a second page of controls and then press the  button.

### Controlling Playback

Touch the arrows and scroll bar to the right of the movie names to navigate the list. Touch the movie name to play that movie.

While viewing an MPEG movie, touch the bottom half of the screen to access the following on-screen controls:



- : Access the direct entry screen
- : View the SETUP menu
- : Close on-screen menu
- : Fast forward x2, x4, x8, x20
- : Previous photo
- : Play/pause
- : Next photo
- : Fast reverse x2, x4, x8, x20
- : Stop playback and return to the USB menu
-  and : View a second screen of menu choices
- : (x1) Repeat Single, (x2) Repeat Folder, (x3) Repeat Off
- : Quick access to Equalizer level settings
- AUDIO**: Send audio to Left or Right speakers or listen in Stereo
- SUBTITLE**: Choose from available subtitle languages
- : Activate/deactivate Random mode
- : View the first screen of menu choices

17. **DISP**: Display file information (file name and track number)

***Returning to the Music Interface***

To return to the music interface, touch the 🎵 icon to list audio files. Touch to select an audio file and begin playback. Touch the 📄<sup>2/2</sup> button to view MP3 playback controls.

## XM® RADIO OPERATION

*Listeners can subscribe to XM® Radio on the Web by visiting [www.xmradio.com](http://www.xmradio.com), or by calling (800) 967-2346. Customers should have their Radio ID ready (see "Displaying the Identification (ID) Code"). Customers can receive a limited number of free-to-air channels without activation.*

### Accessing XM® Radio Mode



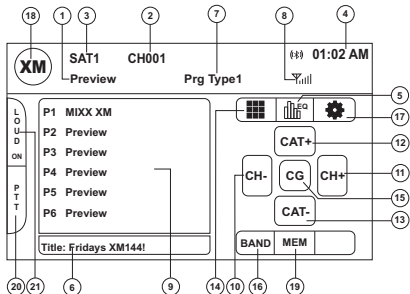

Press the **SRC** button (2) on the front panel or remote control (8) to switch to the XM source.



1. XM channel name
2. XM channel number
3. XM band
4. Time
5. **EQ**: Adjust preset equalizer settings
6. Song title, artist name
7. Category
8. Signal strength indicator
9. Current preset channels/on-screen preset buttons
10. **CH-**: Select the previous channel
11. **CH+**: Select the next channel
12. **CAT+**: Select next channel in current category only
13. **CAT-**: Select previous channel in current category only
14. Touch to enter channel directly using the on-screen keypad
15. **CG**: Access Channel/Category Guide mode

16. **BAND**: Change between XM1, XM2 and XM3 bands
17. : View the SETUP menu
18. Touch this area to view the SOURCE MENU and select a new playback source
19. **MEM**: View screen used to enter current channel into preset memory
20. **PTT**: Activate the Push To Talk voice recognition feature. See "iPod Voice Control" on page 16.
21. **LOUD**: Turn the loudness feature on/off

**Table 9: XM Radio Remote Control Functions**

 <b>BAND</b>	Select SAT1, SAT2, SAT3 band
	Previous channel
	Next channel
	Browse category
	Browse category
<b>1-9, 0</b>	Direct entry
<b>EQ</b>	Access equalizer menu
<b>GOTO</b>	Access direct entry keypad
<b>PTT</b>	Push to talk

## Displaying the Identification (ID) Code

Before you listen to satellite radio, you must subscribe to the service using your radio's identification number. To display the radio ID, touch the **CH-** or **CH+** buttons on the screen repeatedly to tune to channel "000". The screen displays the radio ID where the channel name is usually displayed.

## Selecting a Station

Touch the **CH-** or **CH+** buttons on the screen to select a different station.

## Preset Mode

To enter preset mode, touch the **BAND** button on the screen or remote control (20) to change between the following bands: SAT1, SAT2, or SAT3 (indicated in the top left corner of the TFT screen).

Six numbered preset buttons store and recall stations for each band. All six stored stations (P1-P6) for the current band appear on the TFT screen.

### Storing a Station

1. Select a band (if needed), then select a station.
2. Touch the on-screen **MEM** button to open the preset screen.

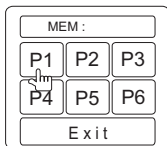

3. Touch the preset number in which you would like to store the current station (or press **Exit** to cancel and close the menu). The preset number and station appears highlighted.

### Recalling a Station

1. Select a band (if needed).
2. Touch an on-screen preset button to select the corresponding stored station.

### Direct Tuning

To enter a radio station directly, touch the  button or press the **GOTO** button (21) on the remote control to display the direct entry menu.

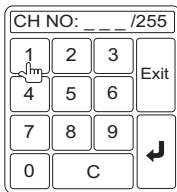

Enter the desired radio station using the on-screen number pad. Touch the arrow (enter) button to tune to the selected station. To exit the screen without changing the station, touch **Exit**. To clear your entry and start over, touch **C**.

## Channel/Category Guide Mode

There are two search modes to help navigate through channels and or categories. To access the Channel/Category Guide mode, touch the **CG** button.

Channel Guide is the default search mode. To access Category Guide, press the **SUBTITLE** button (9) on the remote control or touch **CAT** on the touch screen. To return to Channel Guide, touch **CH** on the screen or press the **TITLE** button (2) on the remote control.

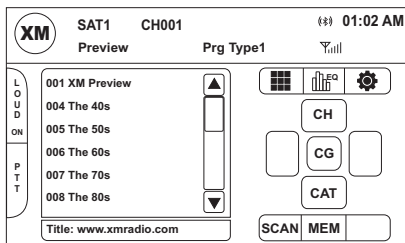

### Channel Guide Mode

When Channel Guide mode is selected, the first six satellite channels are displayed in the boxes in the bottom left of the TFT screen and the on-screen menu changes to facilitate search mode.

- While in Search Mode, to switch between Channel and Category search modes, touch the **CH** or **CAT** buttons on the screen.
- Use the scroll bar and arrows on the touch screen to view the next/previous page of stations. Each page contains six channels to select from.
- Touch the on-screen **SCAN** button to preview each of the 6 channels displayed for 10 seconds.
- Touch the **CG** button to return to the Preset Mode screen.
- To select a channel while in Channel Guide mode, touch the channel name on the screen. The channel will begin playing and the unit will return to the Preset Mode.



### **Category Guide Mode**

When Category Mode is selected, folder icons appear on the screen next to category choices.

- While in Search Mode, to switch between Channel and Category search modes, touch the **CH** or **CAT** buttons on the screen.
- Use the scroll bar and arrows on the touch screen to view the next/previous page of categories. Each page contains six categories to select from.
- To select a category, touch the corresponding category name or folder icon. The channels in that category will be displayed on the screen.
- Use the scroll bar and arrows on the touch screen to view the next/previous six stations in the selected category.
- Touch the on-screen **SCAN** button to preview each channel in the selected category for 10 seconds.
- Touch the channel name to play that channel.
- Touch the on-screen **CG** button to return to the Preset Mode screen.

## iPod OPERATION

**NOTE:** Be sure your iPod has the latest Apple firmware installed to avoid connectivity issues.

### Accessing iPod Mode

This unit is Made for iPod and works with iPhone. You can control your iPod via touch screen to access Playlist, Artist, Album, Songs, etc. Supported models include, but are not limited to, the following:

- iPod Classic
- iPod Touch 2G / 3G
- iPod Nano 3G / 4G / 5G
- iPhone 3G / 3GS







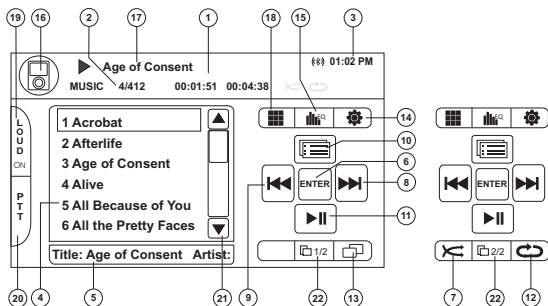



The unit will automatically switch to iPod mode when an iPod or iPhone is plugged into the front USB connector.

**NOTE:** For basic iPod connectivity, you can use the white 30-pin to USB iPod cable that came with your Apple device. For iPod video or photo playback, you must purchase the jLink-USB cable.







To return to the iPod menu from any other source menu, press the **SRC** button (2) on the front panel or remote control (8) until the iPod menu appears on the screen. The on-screen indicators and touch key areas for iPod playback are outlined below.



1. Elapsed playing time/total playback time

2. File number and total number of files on the iPod
3. Current time
4. File titles
5. ID3 information (Artist/Album)
6. **ENTER**: Touch to "Enter"
7. : Activate/deactivate Random mode
8. : Next track
9. : Previous track
10. : iPod Menu
11. : Play/pause
12. : (x1) Repeat Single, (x2) Repeat All
13. : View the song title screen
14. : View the SETUP menu.
15. : Quick access to Equalizer level settings.
16. (a) Current source  
(b) Touch to view the SOURCE MENU and select a new source
17. Current file title
18. : Access the direct entry screen.
19. **LOUD**: Turn loudness features ON/OFF
20. **PTT**: Activate the Push To Talk voice recognition feature. See "iPod Voice Control" on page 16.
21. Touch the arrows and scroll bar to navigate the list.
22. **1/2, 2/2**: Touch to move between page 1 and 2 of the on-screen controls

**Table 10: iPod Remote Control Functions**

<b>RPT</b>	Press once to repeat song, twice to repeat album
<b>SUBTITLE</b>	Select photo menu
<b>ANGLE</b>	Select video menu
<b>AUDIO</b>	Select music menu
	Previous file
	Next file
	Play/Pause
	Menu up
	Menu select (enter) or play/pause
	Stop (press  to resume playback)
<b>1-9, 0 (Keypad)</b>	Direct enter file number for playback

## Controlling your iPod

Touch the button or press the following remote control buttons to access the main iPod menu.

Menu	Remote Control
Music	AUDIO
Photos	SUBTITLE
Videos	ANGLE

Use the touchscreen or the directional keys on the remote control to navigate the iPod menus.

### File Playback

To access files, touch the button on screen until you return to the main iPod menu and then select "MUSIC," "VIDEO" or "PHOTO" or press the remote control button indicated in the table above.

- Use the touch screen to navigate the iPod menu and select a file for playback.
- Touch the button to return to the previous screen.
- Touch the button on screen or the (18) on the remote control to play/pause.
- Touch on screen or press the (19) on the remote control to move to the next item on the menu.
- Touch on screen or press the (17) on the remote control to move to the previous item on the menu.

During music playback, the following screen is displayed:



- To return to the iPod music menu from the song title screen, press .

- To return to the Video or Photo menu while viewing video or photo, touch the center of the screen.

---

**NOTE: The jLink USB cable must be used for video playback.**

---

**NOTE: Only the iPod Touch (1, 2, 3 Gen) and iPhones allow photo viewing through the VM9324.**

---

### Fast Forward/Fast Reverse

Press and hold the |◀◀ or ▶▶| buttons on screen or on the remote control (17, 19) for 1 second and continue to hold for fast forward or fast reverse. Release to resume normal play.

### Direct Track Entry

To select a track directly, touch the  button on screen control to display the direct entry menu.

Enter the desired track using the on-screen number pad. Press the arrow (enter) key to tune to the selected station. To exit the screen without changing the station, touch **Exit**. To clear your entry and start over, touch **Clear**.



---

**NOTE: To transmit the video from your iPod to the VM9324 screen, you must set the following options through the iPod video settings menu: TV Out = On, TV Signal = NTSC, and Widescreen = On.**

**NOTE: After disconnecting your iPod, the VM9324 will always return to the last mode accessed when the iPod is plugged back into the unit.**

---

---

## BLUETOOTH OPERATION

---

***NOTE: Bluetooth operation requires an optional BTM15 accessory.***

***The BTM15 module has a secondary microphone for voice recognition. When installing the BTM15, the original single microphone that came with the VM9324 can be disconnected and the BTM15 secondary microphone can be used.***

***This connectivity eliminates the original microphone and allows the BTM15 to perform voice recognition and Bluetooth functions for a cleaner looking installation.***

---

### About Bluetooth

Bluetooth is a short-range wireless radio connectivity technology that is developed as a cable replacement for mobile phones, handheld PCs and other devices. Bluetooth operates in 2.4 GHz frequency range and transmits voice and data at speeds up to 1 megabit per second. Bluetooth was launched by a special interest group (SIG) comprised of Ericsson Inc., Intel Corp., Nokia Corp., Toshiba and IBM in 1998, and it is currently developed by nearly 2,000 companies worldwide. The Bluetooth word mark and logos are owned by the Bluetooth SIG, Inc. and any use of such marks by Audiovox Corporation is under license. Other trademarks and trade names are those of their respective owners.

---

***NOTE: The line-of-sight distance between this unit and your cellular phone must be 8 meters or less for sending and receiving voice and data via Bluetooth wireless technology. However, the transmission distance may become shorter than the estimated distance, depending on the environment in use.***

---

Before attempting to use the Bluetooth functions on the VM9324, you must purchase and install the BTM15. When connected properly, the blue light appears illuminated. Bluetooth features are only available when the BTM15 is installed.

Please make sure your mobile phone supports Bluetooth functions (Headset or Handsfree profiles or both). Adhere to the following guidelines for successful operation.

- Before using Bluetooth functions, you must pair your mobile phone to the VM9324 head unit (see "Pairing the Bluetooth System with Your Mobile Phone and Head Unit"). To ensure the best reception for pairing and re-connection, please make sure the phone battery is fully charged before you begin.

- Try to perform pairing within a few minutes of the phone being turned on.
- Once the unit has been paired with the phone, the unit's model number, "VM9324", will be displayed on the mobile phone.
- To achieve the best performance, always keep the mobile phone within 3 meters of the head unit.
- Always keep a clear path between the mobile phone and the head unit. Never place a metal object or any other obstacle between the mobile phone and the head unit.
- Some mobile phones (like Sony Ericsson) may have a "Power Saving Mode" option. PLEASE DO NOT use the power saving mode with the VM9324.
- Before accepting or making a call, make sure your mobile phone's "Bluetooth function" is turned on.
- To ensure the best conversation quality/performance, stay within one meter of the BTM15 when talking.
- To "disconnect" the mobile phone from the head unit, turn the Bluetooth connectivity off on the mobile phone or touch the  button.
- Phone Book direct searching through the head unit is only available if the mobile phone supports Phone Book Download. If the feature is not supported, the head unit will display "Unavailable" when an attempt is made to download a phone book.

---

***NOTE: Initial phone book indexing may take a few minutes and the data downloads to the phone.***

---



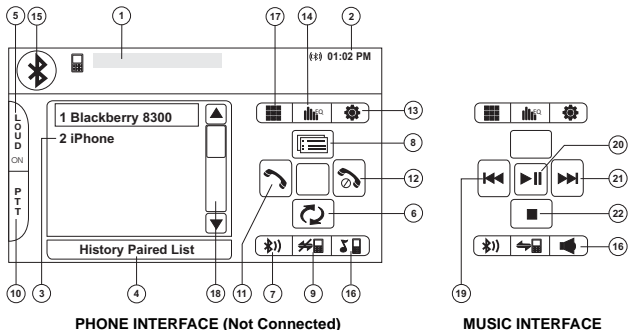

## Bluetooth User Interface

The on-screen indicators and touch key areas for Bluetooth operation are outlined below.







1. Name of connected device
2. Current time
3. List of previously paired devices
4. Current operation status
5. **LOUD**: Turn loudness features ON/OFF
6. : Transfer active call back to handset
7. : Pair your Bluetooth phone (first time use)
8. : Call list menu
9. : Connect/disconnect Bluetooth device (phone, PDA, personal music player, etc.) with hand-free function
10. **PTT**: Activate the Push To Talk voice recognition feature. See "iPod Voice Control" on page 16.
11. : Answer incoming call/make call
12. : Reject incoming call/end call/quit pairing process/quit reading phone book or call listing
13. : View the SETUP menu.
14. : Quick access to Equalizer level settings.
15. (a) Current source  
(b) Touch to view the SOURCE MENU and select a new source
16. : Toggle Phone/Music interface



17. : Access the direct entry screen
18. Touch the scroll bar and arrows to view the previous/ next page of choices (only visible when needed)
19. : Previous file
20. : Play/pause
21. : Next file
22. : Stop A2DP playback

**Table 11: Bluetooth Remote Control Functions**

	Play/pause music playback (not compatible with all phones)
	Stop music playback/hang up or ignore call
	Previous file during music playback (not compatible with all phones)
	Next file during music playback (not compatible with all phones)
<b>1-9, 0</b>	Direct phone number entry
<b>GOTO</b> / 	Access direct entry keypad/answer or dial selected number
<b>PTT</b>	Push to talk



## Hands Free Profile (HFP)

To use a phone wirelessly with this unit, it is necessary to first establish a connection using Bluetooth wireless technology. Connection is normally established using HFP (Hands Free Profile), which gives you full control of functions available on the telephone source. However, depending on your phone, the connection may be made using HSP (Head Set Profile), making some functions unavailable. This is a limitation of your phone, not the VM9324.

Since there are a number of Bluetooth mobile phone implementations available on the market, operations with your Bluetooth mobile phone using this unit vary greatly.

Please refer to the instruction manual that came with your Bluetooth mobile phone along with this manual while operating your phone with this unit.

## Pairing the Bluetooth System with Your Mobile Phone and Head Unit

1. Press the  button (7) to initiate the pairing process. Keep the mobile phone within 2 meters of the head unit when pairing. (To terminate the pairing process, press the  button again.)
2. Select the Bluetooth setup option on the mobile phone to be paired (please refer to the phone's instruction manual to learn how to enter Bluetooth setup, turn Bluetooth on/off, and perform pairing).

---

***NOTE: Some phones require a "pass key" or pairing code to connect. If your phone requires a pass key or pairing code, you will need to enter this number in the Pairing Code field under the Bluetooth SETUP menu. The default pairing code for many phones is "0000". The default code for the VM9324 is "1234". See "BT (Bluetooth) Sub-menu Features" on page 23 for instructions on entering the pairing code.***

---

3. Select "VM9324" from the pairing list on the mobile phone.
  - If pairing is successful, the TFT will display the paired mobile phone model number or name (as specified in your phone's Bluetooth Setup menu).
  - If pairing fails, "Phone Pairing Fail" is displayed at the bottom of the screen.

## Reconnecting

Once the Bluetooth device has been paired, you can touch the connect  button (9) to reconnect.

---

**NOTE:** *You can only connect to a phone using the buttons on the on-screen Phone interface.*

---

Each time the  button is pressed, the head unit will automatically reconnect with the mobile phone once (only if the mobile phone was previously paired with the head unit).

## Managing Incoming Calls

When connected to a Bluetooth phone, the unit will mute audio output, pause CD play, and change to the Bluetooth screen when a call is received. An incoming phone number will appear at the top of the screen.

### Answering an Incoming Call

To answer the call, touch the  button (11).

---

**NOTE:** *The TALK button on the BTM15 can be used to answer calls or hang up.*

---

For best reception, speak loudly and clearly.

To end the conversation, press the  button (12). The screen will display the call duration for 3 seconds, and then return to the previous mode.

### Rejecting an Incoming Call

Touch the  button to reject an incoming call. The call will revert to your phone and can be answered directly or left for voice mail.

### Volume Control

To increase or decrease the volume level, turn the **AUDIO** control (1) on the front panel or press the **VOL+ / VOL-** buttons on the remote control (15, 16).

## Making an Outgoing Call

---

**NOTE:** *Press the  button from the main Bluetooth screen to automatically dial the last call received.*

---

1. Touch the button to open the direct dial screen.



2. Use the 0-9, \*, and # buttons to input the phone number. Touch the **C** button to clear the last digit.
3. After entering the phone number, press the button to dial the call. The direct dial screen will close once your call is connected.

To end the conversation, press the button.

## Call Transfer

While talking, to transfer audio from the head unit back to the mobile phone, touch the button (6). The TFT will display "Transfer". You can only transfer a call after it has been answered.

## Menu List

The menu list appears on the left side of the screen and can be accessed from other modes by touching the button on the right side of the screen.

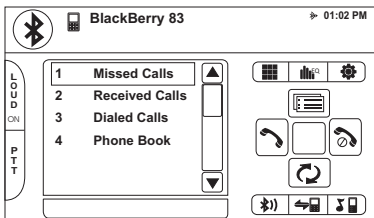



---



**NOTE: Not all phones allow access to missed, received or dialed calls and some will not allow uploading of your phone's address book.**

---



### **Missed Calls**

The Missed Calls list retrieves the list of Missed numbers from your phone. The last missed number is the first number on the list. Touch the Missed Calls menu option to view the list. To make a call from the Missed Calls list, touch the number (the selected number appears at the top of the screen) and then touch the  button. The TFT will display "Unavailable" when the feature is not available. Touch the  button to return to the menu list.

### **Received Calls**

Use the Received Calls list to view the last 10 received numbers stored on your phone. To access the Received list, touch the Received Calls menu option. The last received number is the first number on the list. To make a call from the Received Calls list, touch the number (the selected number appears at the top of the screen) and then touch the  button. The TFT will display "Unavailable" when the feature is not available. Touch the  button to return to the menu list.

### **Dialed Calls**

The Dialed Calls list retrieves the list of dialed numbers from your phone. The last dialed number is the first number on the list. Touch the Dialed Calls menu option to view the list. To make a call from the Dialed Calls list, touch the number (the selected number appears at the top of the screen) and then touch the  button. The TFT will display "Unavailable" when the feature is not available. Touch the  button to return to the menu list.

### **Phone Book**

1. Touch the Phone Book menu option to display the phone book stored on your mobile phone, if compatible.
2. Once the download is completed, you can use the arrow buttons and scroll bar on the right side of the window to navigate the list.
3. Touch to highlight the number you want to dial (the selected number appears at the top of the screen) and then touch the  button.

---

**NOTE: Some mobile phones do not support Phone Book upload through Bluetooth. This is a limitation of the phone, not the VM9324.**

---

## Bluetooth Setup

### **Auto Answer**

You can choose to have the VM9324 automatically answer incoming calls to your paired Bluetooth phone. To turn “Auto Answer” on:

1. Touch the  button to view the SETUP menu.
2. Select the “BT” sub-menu.
3. Touch the area to the right of “Auto Answer” to select “On”.

### **Auto Connect**

The auto Connect option will allow the VM9324 to automatically connect to your previously paired Bluetooth when it is in range. When the “Auto Connect” option is set to “Off”, you must press the  button to re-establish a connection with your phone. To turn “Auto Connect” on:

1. Touch the  button to view the SETUP menu.
2. Select the “BT” sub-menu.
3. Touch the area to the right of “Auto Connect” to select “On”.

## Advanced Audio Distribution Profile (A2DP)

The VM9324 allows you to play back audio files from your phone, PDA or personal music player using a Bluetooth connection.

Before using an audio player, it may be necessary to enter a PIN code into the unit. Enter the PIN code referring to “BT (Bluetooth) Sub-menu Features” on page 23.

---

***NOTE: Please quit A2DP mode before attempting to make a phone call, as unexpected results may occur depending on your mobile phone model.***

---

The VM9324 can control a Bluetooth audio player via Advanced Audio Distribution Profile (A2DP) or Audio/Video Remote Control Profile (AVRCP). Bluetooth audio players (or Bluetooth adapters) compatible with these profiles can be connected to this unit. Functionality varies depending on the profile used.

## **REAR CAMERA FUNCTION**

This unit is "camera ready." Before accessing any camera features, you must install a rear video camera. When the camera is not installed and the function is accessed by gear selector being placed in reverse or by the unit's menu, the message "NO VIDEO SIGNAL" will appear, indicating the function is not available.

When the camera is installed, the rear view image of what's behind the vehicle will appear when the vehicle's is placed in reverse gear. When leaving reverse gear, the unit displays the previous screen. The rear camera image can be adjusted from Normal to Mirror using the "Setup" menu (see "VIDEO Sub-menu Features" on page 22).

# TROUBLESHOOTING

Table 12: Troubleshooting

Problem	Cause	Corrective Action
<b>GENERAL</b>		
Unit will not power on	Radio Fuse blown	Install new fuse with correct rating
	Car battery fuse blown	Install new fuse with correct rating
	Illegal operation	Press the RESET button located in the bottom right corner of the front panel
Remote control does not function	Battery depleted	Replace battery with new one
	Battery installed incorrectly	Remove battery and install correctly
No/low audio output	Improper audio output connection	Check wiring and correct
	Volume set too low	Increase volume level
	Improper "MUTE" connection	Review wiring diagram and check "MUTE" connection
	Speakers damaged	Replace speakers
	Heavily biased volume balance	Adjust the channel balance to the center position
	Speaker wiring is in contact with metal part of car	Insulate all speaker wiring connections
Poor sound quality or distortion	Pirated disc is in use	Use original copy
	Speaker power rating not compatible with unit	Connect proper speakers
	Speaker is shorted	Check speaker contact
Unit resets itself when engine is off	Incorrect connection between ACC and positive battery wire	Check wiring and correct
<b>TFT MONITOR</b>		
Monitor does not open automatically	TFT Auto Open is turned off	Turn TFT Auto Open on
No image	Incorrect connection to parking brake wire	Check wiring and correct
	Parking brake is not engaged	Stop vehicle in safe place and apply parking brake
Flashing image or interference appears on screen	DVD is not compatible with current TV system settings	Change setup to accommodate disc
	Improper video signal connections	Check wiring and correct



Table 12: Troubleshooting

Problem	Cause	Corrective Action
Prolonged image or improper height/width ratio display	Improper aspect ratio setup	Use correct aspect ratio setting
Monitor stops at incorrect position	Moving path is blocked	Press OPEN key to restart monitor movement
<b>TUNER</b>		
Weak station searching	Auto antenna is not fully extended	Connect the auto antenna control cable properly
	Auto antenna not properly connected	Connect the auto antenna control cable properly
	LOCAL function is activated	Turn LOCAL function off
Cannot insert disc	Disc already inside unit	Eject current disc and insert new one
Image blurred, distorted, or dark	Disc is illegally copied	Use original disc
Disc does not play back	Disc is warped or scratched	Use disc in good condition
	Disc is dirty or wet	Clean disc with soft cloth
	Laser pickup is dirty	Clean laser pickup with cleaning disc
	Incompatible disc is used	Use compatible disc
	Disc rating exceeds Parental Lock rating limit	Change Parental Lock settings to lower restriction
	Disc region code is not compatible with unit	Use disc with proper region code
	Disc is inserted upside down	Insert disc with label side up
PBC cannot be used during VCD playback	PCB is not available on the disc	
No repeat or searching while playing VCD	PCB is on	Turn PCB off
<b>MP3</b>		
Interruption occurred during playback	Disc is dirty or scratched	Clean disc or replace
	File is damaged/bad recording	Recreate disc with good files

**Table 12: Troubleshooting**

<b>Problem</b>	<b>Cause</b>	<b>Corrective Action</b>
Incorrect play-back message displayed	Message is longer than LCD can display	

## Error Messages

**Table 13: Error Messages**

<b>Message Displayed</b>	<b>Cause</b>	<b>Corrective Action</b>
Loading	Disc is being read	
No Disc	Disc is dirty	Clean disc with soft cloth
	Disc is upside down	Insert disc with label side up
	Disc not present in loading compartment	Insert disc
Bad Disc	Disc is dirty	Clean disc with soft cloth
	Disc is upside down	Insert disc with label side up
Unknown disc	Disc format is not compatible with this unit	
Region Error	DVD is not compatible with region code of unit	
Error	Illegal mechanism operation	Press EJECT key for 5 seconds to reset loading mechanism

## Care and Maintenance

1. Use only a clean silicone cloth and neutral detergent to clean the front panel or monitor. A rough cloth and non-neutral detergent (such as alcohol) may result in scratching or discoloration.
2. Do not get water or cleaning fluids on the unit.
3. If the temperature inside the player gets too hot, a protective circuit automatically stops play of the disc. If this occurs, allow the unit to cool before operating the player again.
4. Never insert anything other than a 5" (12 cm) compact disc into the player as the mechanism can be damaged by foreign objects.
5. Do not attempt to use a 3" (8 cm) CD-Single disc in this unit, either with or without an adaptor, as damage to the player and/or disc may occur. Such damage is not covered by the Warranty on this product.
6. The CD player may not operate properly in extreme hot or cold. If such conditions occur, allow the interior of the vehicle to reach a normal temperature before using player.
7. When the vehicle warms up during cold weather or under damp conditions, condensation may appear on the LCD panel. Should this occur, the screen will not operate properly until the moisture has evaporated.
8. We suggest you use a cleaning disc in this unit more frequently than in the unit in your home due to the environmental conditions of the vehicle.

## **SPECIFICATIONS**

### ***DVD/CD Player***

Compatible Disc Media: DVD  $\pm$  R / RW (Single and Dual Layer) and CD-R / RW

Compatible Media Formats: CD-DA, MP3, WMA, VCD, SVCD, Xvid, AVI, MPEG1 / 2

Signal to Noise Ratio: >95dB

Dynamic Range: >95dB

Frequency Response: 20Hz to 20 kHz, -3dB

Channel Separation: > 60dB @ 1 kHz

D/A Converter: High performance 24-bit / 192 kHz sample rate, Multi-Bit Sigma-Delta Modulator

### ***Video***

Format: NTSC, PAL (auto-detection)

Output: 1Vp-p (75-ohm)

Input: 1Vp-p (75-ohm)

### ***FM Analog Tuner***

Tuning Range: 87.5MHz - 107.9MHz

Mono Sensitivity (-30dB): 9dBf

Quieting Sensitivity (-50dB): 15dBf

Alternate Channel Selectivity: 70dB

Signal to Noise Ratio @ 1 kHz: 58dB

Image Rejection: 80dB

Stereo Separation @ 1 kHz: >30dB

Frequency Response: 30Hz - 15 kHz, -3dB

### ***HD Radio Tuner***

FM: Hybrid -89 dBm, (40 dBf), All Digital -112 dBm (17dBf)

AM: Hybrid -93, dBm, (36 dBf) All Digital -103 dBm (25dBf)

Stereo Separation: 70 dB

Audio THD: .4%

Frequency Response (+/-3dB) 20 Hz - 18 kHz

Signal-to-Noise Ratio (Stereo): 70 dB

### ***AM Tuner***

Tuning Range: 530 kHz - 1710 kHz

Sensitivity (-20dB): 12uV

Signal to Noise Ratio @ 1 kHz: 50dB

Image Rejection: 60dB

Frequency Response: 150Hz - 2 kHz, -3dB

**Monitor**

Screen Size: 6.2" Hi-Res TFT Active Matrix  
Resolution: 1,152,000 Sub Pixels (480 x 2400)

**General**

Auxiliary Input impedance: 10k  
Power Supply: 11 to 16VDC, negative ground  
Power Antenna (Blue): 500mA max, current limited protection  
Amplifier Remote (Blue/White): 500mA max, current limited protection  
Operating Temperature: -20C ~ 65C  
Fuse: 15-amp, mini ATM type  
DIN chassis dimensions: 7" X 7" X 4" (178mm x 178mm x 100mm)

**CEA Power Ratings**

Power Output: 13 Watts RMS x 4 channels into  
4-Ohms @  $\leq 1\%$  THD+N

Signal to Noise Ratio: 70dBA below reference  
(Reference: 1 Watt, 4-Ohms)

Frequency Response: 20 Hz - 20 kHz, -3dB.  
(Aux Input used as reference input)

Reference Supply Voltage: 14.4VDC

*\*Specifications subject to change without notice.*







Audiovox Electronics Corporation  
Hauppauge, NY 11788  
Technical Assistance: 1-800-323-4815  
[www.jensen.com](http://www.jensen.com)

© 2010 Audiovox  
Ver. 051210  
Printed in China

## Free Manuals Download Website

<http://myh66.com>

<http://usermanuals.us>

<http://www.somanuals.com>

<http://www.4manuals.cc>

<http://www.manual-lib.com>

<http://www.404manual.com>

<http://www.luxmanual.com>

<http://aubethermostatmanual.com>

Golf course search by state

<http://golfingnear.com>

Email search by domain

<http://emailbydomain.com>

Auto manuals search

<http://auto.somanuals.com>

TV manuals search

<http://tv.somanuals.com>