

3-SPEED STEREO TURNTABLE 3 CD CHANGER MUSIC SYSTEM WITH DUAL CASSETTE DECK AND REMOTE CONTROL



OWNER'S MANUAL JMC-1100

**PLEASE READ THIS OPERATING MANUAL COMPLETELY BEFORE OPERATING
THIS UNIT AND RETAIN THIS BOOKLET FOR FUTURE REFERENCE.**

DEAR JENSEN® CUSTOMER

Selecting fine audio equipment such as the unit you've just purchased is only the start of your musical enjoyment. Now it's time to consider how you can maximize the fun and excitement your equipment offers. This manufacturer and the Electronic Industries Association's

Consumer Electronics Group want you to get the most out of your equipment by playing it at a safe level. One that lets the sound come through loud and clear without annoying blaring or distortion and, most importantly, without affecting your sensitive hearing.

Sound can be deceiving. Over time your hearing "comfort level" adapts to higher volumes of sound. So what sounds "normal" can actually be loud and harmful to your hearing. Guard against this by setting your equipment at a safe level BEFORE your hearing adapts.

To establish a safe level:

- Start your volume control at a low setting.
- Slowly increase the sound until you can hear it comfortably and clearly, and without distortion.

Once you have established a comfortable sound level:

- Set the dial and leave it there.

Taking a minute to do this now will help to prevent hearing damage or loss in the future. After all, we want you listening for a lifetime.

We Want You Listening For a Lifetime

Used wisely, your new sound equipment will provide a lifetime of fun and enjoyment. Since hearing damage from loud noise is often undetectable until it is too late, this manufacturer and the Electronic Industries Association's Consumer Electronics Group recommend you avoid prolonged exposure to excessive noise.

Customer's Record:

The serial number of this product is found on its back cover. You should note the serial number of this unit in the space provided as a permanent record of your purchase to aid in identification in the event of theft or loss.

Model Number: JMC-1100

Serial Number: _____

WARNING

TO PREVENT FIRE OR SHOCK HAZARD, DO NOT USE THIS PLUG WITH AN EXTENSION CORD, RECEPTACLE OR OTHER OUTLET UNLESS THE BLADES CAN BE FULLY

INSERTED TO PREVENT BLADE EXPOSURE. TO PREVENT FIRE OR SHOCK HAZARD, DO NOT EXPOSE THIS APPLIANCE TO RAIN OR MOISTURE.



IMPORTANT SAFETY INSTRUCTIONS

1. Read these instructions - All the safety and operating instructions should be read before the appliance is operated
2. Keep these instructions - The safety and operating instructions should be kept for future reference.
3. Heed all warnings - All warnings on the appliance and in the operating instructions should be adhered to.
4. Follow all instructions - All operation and use instructions should be followed.
5. Do not use this apparatus near water - The appliance should not be used near water; for example, near a bathtub, washbowl, kitchen sink, laundry tub, in a wet basement, or near a swimming pool, and the like.
6. Clean only with dry cloth - The appliance should be cleaned only as recommended by the manufacturer.
7. Do not block any ventilation openings. Install in accordance with the manufacturer's instructions. - The appliance should be situated so that its location or position does not interfere with its proper ventilation. For example, the appliance should not be situated on a bed, sofa, rug, or similar surface that may block the ventilation openings; or placed in a built-in installation, such as a bookcase or cabinet that may impede the flow of air through the ventilation openings.
8. Do not install near any heat sources such as radiators, heat registers, stoves or other apparatus (including amplifiers) that produce heat.
9. Do not defeat the safety purpose of the polarized or grounding-type plug. A polarized plug has two blades with one wider than the other. A grounding type has two blades and a third grounding prong. The wide blade or the third prong are provided for your safety. If the provided plug does not fit into your outlet, consult an electrician for replacement of the obsolete outlet.
10. Protect the power cord from being walked on or pinched particularly at plugs, convenience receptacles, and the point where they exit from the apparatus.
11. Only use attachments / accessories specified by the manufacturer
12. Use only with the cart, stand, tripod, bracket, or table specified by the manufacturer, or sold with the apparatus. When a cart is used, use caution when moving the cart/apparatus combination to avoid injury from tip-over.



2

13. Unplug this apparatus during lightning storms or when unused for a long periods of time.
14. Power Sources - The appliance should be connected to a power supply only of the type described in the operating instructions or as marked on the appliance. Do not overload wall outlet.
15. Wall and Ceiling Mounting - The appliance should be mounted to a wall or ceiling only as recommended by the manufacturer.

16. Power Lines - An outdoor antenna should be located away from power lines.
17. Outdoor Antenna Grounding - If an outside antenna is connected to the receiver, be sure the antenna system is grounded so as to provide some protection against voltage surges and built up static charges. Section 810 of the National Electrical Code, ANSI/ NFPA No.70-1984, provides information with respect to proper grounding of the mast and supporting structure, grounding of the lead-in wire to an antenna discharge unit, size of grounding conductors, location of antenna discharge unit, connection to grounding electrodes, and requirements for the grounding electrode. See figure 1.

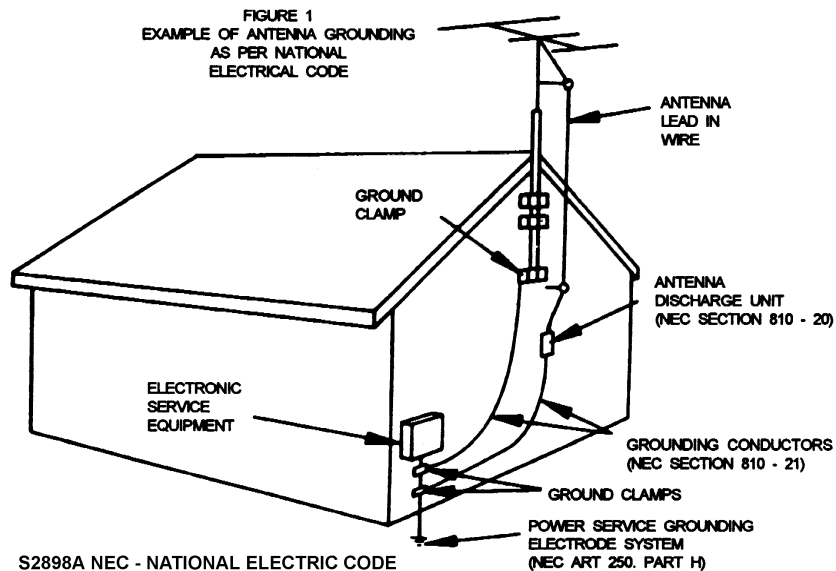

18. Object and Liquid Entry - Care should be taken so that objects do not fall and liquids are not spilled into the enclosure through openings.
19. Refer all servicing to qualified service personnel. Servicing is required when the apparatus has been damaged in any way, such as power-supply cord or plug is damaged, liquid has been spilled or objects have fallen into the apparatus, the apparatus has been exposed to rain or moisture, does not operate normally, or has been dropped.
20. Servicing - The user should not attempt to service the appliance beyond that described in the operating instructions. All other servicing should be referred to qualified service personnel.
21. The MAINS plug or an appliance coupler is used as the disconnect device, the disconnect device shall remain readily operable.
22. Battery pack or battery installed should not be exposed to excessive heat such as sunshine, fire or the like.
23. Caution marking and nameplate are located on back of product.

Caution

Danger of explosion if battery is incorrectly replaced. Replace only with the same or equivalent type.

The apparatus shall not be exposed to dripping or splashing and that no objects filled with liquids, such as vases, shall be placed on apparatus.

CAUTION

TO PREVENT ELECTRIC SHOCK, MATCH WIDE BLADE OF PLUG TO WIDE SLOT. FULLY INSERT THE PLUG TO MAIN POWER SOCKET.

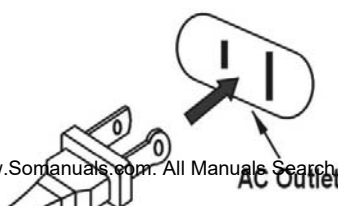

CAUTION

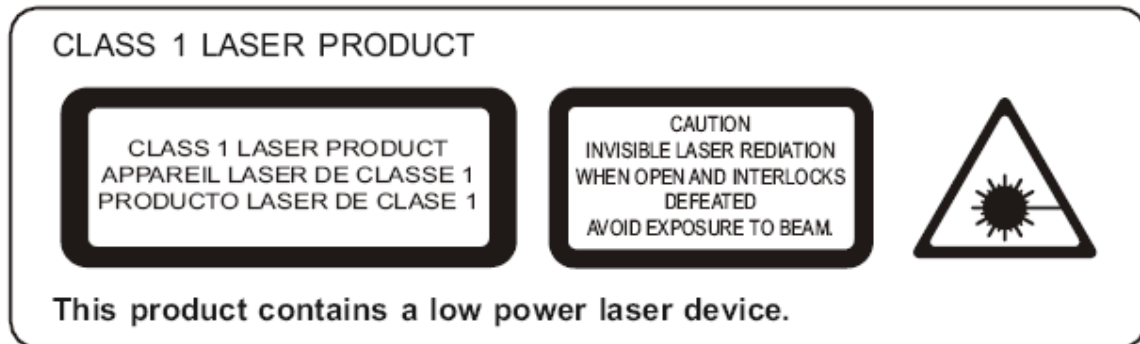

Note: This product complies with DHHS Rule 21 Subchapter J at date of manufacture.

Follow the advice below for safe and appropriate operation.

ON PROTECTION AGAINST LASER ENERGY EXPOSURE

- As the laser beam used in this compact disc player is harmful to the eyes, do not attempt to disassemble the casing.
- Stop operation immediately if any liquid or solid object should fall into the cabinet.
- Do not touch the lens or poke at it. If you do, you may damage the lens and the player may not operate properly.
- Do not put anything in the safety slot. If you do, the laser diode will be ON when the CD door is still open.
- This unit employs a laser. The use of controls or adjustment or performance of procedures other than those specified here may result in exposure to hazardous radiation.

ON PLACEMENT

- Do not use the unit in places which are extremely hot, cold, dusty or humid.
- Place the unit on a flat and even surface.
- Do not restrict the air-flow of the unit by placing it in a place with poor ventilation, by covering it with a cloth or by placing it on a carpet.

4

ON CONDENSATION

- When left in a heated room where it is warm and damp, water droplets or condensation may form inside the unit.
- When there is condensation inside the unit, the unit may not function normally. Let it stand for 1 to 2 hours before turning the power on, or gradually heat the room up and dry the unit before

use.

Should any trouble occur, remove the power source and refer servicing to qualified personnel.

PRECAUTION FORE USE

- **UNPACK ALL PARTS AND REMOVE PROTECTIVE MATERIAL.**
- **DO NOT CONNECT THE UNIT TO THE MAINS BEFORE CHECKING THE MAINS VOLTAGE AND ALL OTHER CONNECTIONS HAVE BEEN MADE.**
- **DO NOT COVER ANY VENTS AND MAKE SURE THAT THERE IS A SPACE OF SEVERAL CENTIMETERS AROUND THE UNIT FOR VENTILATION.**

IMPORTANT NOTES

Avoid installing the unit in locations described below:

- Places exposed to direct sunlight or close to heat radiating appliances such as electric heaters.
- Places subject to constant vibration.
- Dusty, humid or moist places.

PROTECT YOUR FURNITURE !!

This model is equipped with non-skid rubber 'feet' to prevent the product from moving when you operate the controls. These 'feet' are made from non-migrating rubber material specially formulated to avoid leaving any marks or stains on your furniture. However certain types of oil based furniture polishes, wood preservatives, or cleaning sprays may cause the rubber 'feet' to soften, and leave marks or a rubber residue on the furniture. To prevent any damage to your furniture we strongly recommend that you purchase small self-adhesive felt pads, available at hardware stores and home improvement centers everywhere, and apply these pads to the bottom of the rubber 'feet' before you place the product on fine wooden furniture.

This device complies with Part 15 of the FCC Rules. Operation is subject to the following two conditions:

- (1) this device may not cause harmful interference, and
- (2) this device must accept any interference received, including interference that may cause undesired operation.

NOTE : This equipment has been tested and found to comply with the limits for a Class B digital device, pursuant to Part 15 of the FCC Rules. These limits are designed to provide reasonable protection against harmful interference in a residential installation. This equipment generates, uses and can radiate radio frequency energy and, if not installed and used in accordance with the instructions, may cause harmful interference to radio communications. However, there is no guarantee that interference will not occur in a particular installation. If this equipment does cause harmful interference to radio or television reception, which can be determined by turning the equipment off and on, the user is encouraged to try to correct the interference by one or more of the following measures:

- Reorient or relocate the receiving antenna.
- Increase the separation between the equipment and receiver.
- Connect the equipment into an outlet on a circuit different from that to which the receiver is connected.
- Consult the dealer or an experienced radio/TV technician for help.

CAUTION: Changes or modifications not expressly approved by the party responsible for compliance could void the user's authority to operate the equipment.

GETTING START

SPEAKER CONNECTION

1. Insert the speaker cable ends (exposed wires) into the terminals located on the back

of the main unit by pushing down the lever of the left speaker terminal and then the right speaker terminal

2. Connect the left speaker to the left speaker terminal with the red wire to L+ and the black wire to L -.
3. Connect the right speaker to the right speaker terminal with the red wire to R+ and the black wire to R -.

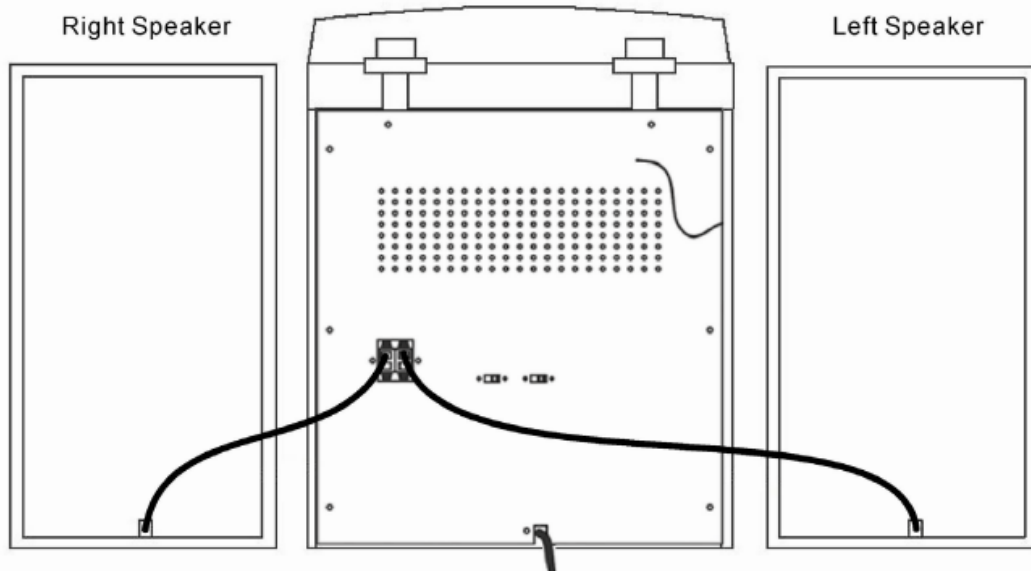

NOTE:

Make sure that the power is switch off when connect or disconnect the speakers. Make sure that the speakers are connected to the correct terminals.

CONNECTING THE AC POWER CORD

After connecting the speakers unwind the AC power cord fully and connect it to any convenient household 120V~ 50Hz AC outlet.

NOTE:

The product is designed to operate on normal 120V~ 60Hz AC only. Connecting this system to any other power supply could result in damage to the unit which is not covered by your warranty. You will noted that this system is equipped with a polarized AC power plug having one blade wider than the other. This is a safety feature.

If this plug does not fit into your existing AC outlet, do not try to defeat this safety feature by filling the wide blade to make it fit into your outlet. If this plug will not fit into your outlet, you probably have an outdated non-polarized AC outlet. You should have your outlet changed by a qualified licensed electrician.

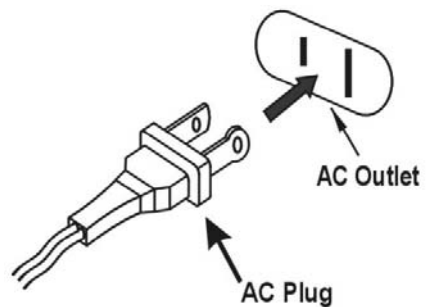

LOCATION OF CONTROLS AND INDICATORS

FRONT VIEW & BACK VIEW

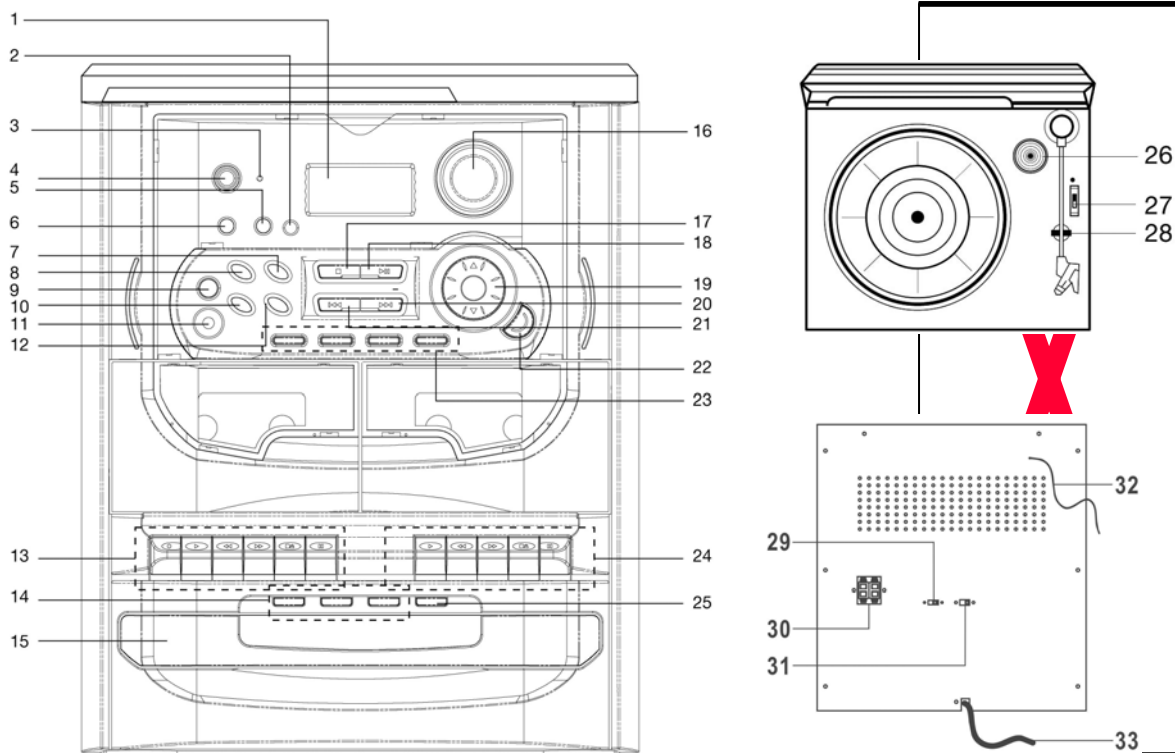

- | | |
|-------------------------------------|--|
| 1) LCD DISPLAY | 14) DISC 1, 2, 3 SELECTOR |
| 2) REMOTE SENSOR | 15) CD DOOR |
| 3) STANDBY LED INDICATOR | 16) PRE-SET EQ BUTTON |
| 4) POWER BUTTON | 17) CD STOP BUTTON |
| 5) MUTE BUTTON | 18) CD PLAY / PAUSE BUTTON |
| 6) FM MODE / DUBBING SPEED SELECTOR | 19) VOLUME UP-DOWN BUTTON |
| 7) MEMEORY / CLOCK ADJUST BUTTON | 20) SKIP / SEARCH / TUNING UP BUTTON |
| 8) SLEEP / TIMER BUTTON | 21) SKIP / SEARCH / TUNING DOWN BUTTON |
| 9) DISC CHANGE BUTTON | 22) EXTRA BASS CONTROL BUTTON |
| 10) RANDOM / M-DN BUTTON | 23) FUNCTION BUTTONS |
| 11) HEADPHONE JACK | 24) DECK 2 CONTROL KEYS |
| 12) REPEAT / M-UP BUTTON | 25) CD DOOR OPEN/CLOSE BUTTON |
| 13) DECK 1 CONTROL KEY | 26) 45RPM RECORD ADAPTOR |
| ● RECORD KEY | 27) 33/45/78 RPM SPEED SELECTOR |
| ▶ PLAYBACK KEY | 28) TONE ARM HOLDER |
| ◀◀ REWIND KEY | 29) AM MODE BEAT CUT 1-2 SELECTOR |
| ▶▶ FAST FORWARD KEY | 30) SPEAKER WIRE TERMINAL |
| ■▲ STOP/EJECT KEY | 31) TURNTABLE AUTO STOP SWITCH |
| PAUSE KEY | 32) FM WIRE ANTENNA |
| | 33) AC POWER CORD |

REMOTE CONTROL

OPEN/CLOSE

PRESS TO OPEN / CLOSE THE CD DOOR

POWER	TURNS THE UNIT POWER ON / STANDBY
DISC 1,2,3	PRESS TO SELECT THE DISC FOR PLAYBACK DIRECTLY
DISC-CH	PRESS TO SELECT THE NEXT DESIRE DISC AND ROTATE THE DISC TRAY
SLEEP	PRESS AND HOLD TO ACTIVE SLEEP FUNCTION
TIMER	ACTIVE/DE-ACTIVE THE ON/OFF TIMER
PHONO	PRESS TO ACTIVE PHONO MODE
EQ	PRESS TO SELECT EQ MODE
MUTE	PRESS TO ACTIVE MUTE FUNCTION
CD	PRESS TO ACTIVE CD MODE
TAPE	PRESS TO ACTIVE TAPE MODE
TUNER/BAND	PRESS TO ACTIVE TUNER MODE AND SELECT AM/FM RADIO BAND
VOLUME +/-	CONTROL VOLUME UP/DOWN
SKIP UP/DOWN	IN CD MODE : TO SELECT PREVIOUS / NEXT CD TRACK IN TUNER MODE : PRESS TO STEP UP/DOWN OF RADIO FREQUENCY IN CLOCK/TIMER MODE: PRESS TO ADJUST HOUR/MINUTE
PLAY/PAUSE	PRESS TO START CD PLAYBACK / PAUSE MODE.
STOP	IN CD MODE, PRESS TO STOP CD PLAYBACK
REPEAT/M-UP	IN CD MODE : PRESS TO ACTIVE THE REPEAT PLAYBACK FUNCTION IN TUNER MODE : PRESS TO RECALL THE PRESET RADIO STATIONS
RANDOM/M-DOWN	IN CD MODE : PRESS TO ACTIVE THE RANDOM PLAYBACK FUNCTION IN TUNER MODE : PRESS TO RECALL OUT THE PRESET RADIO STATIONS
REMAIN	PRESS TO DISPLAY THE REMAINING TIME OF CD PLAYBACK
MEMORY/CLK-ADJ	IN STANDBY MODE, FOR CLOCK SETTING IN TUNER MODE, FOR PRE-SETTING OF RADIO STATION INTO MEMORY IN CD MODE, PRESS TO PROGRAM CD TRACKS.
MODE	TO CHECK CURRENT TIME AND SET THE ON/OFF TIMER
INTRO	PRESS TO START CD INTRO SCAN PLAYBACK

BATTERY INSTALLATION

The battery compartment is located on the back of the remote control.

1. Remove the battery compartment door by pressing in on the tab and lifting it off.

2. Insert two (2) AAA size batteries (not included) into the battery compartment as the polarity markings inside the battery compartment.
3. Replace the battery compartment door.

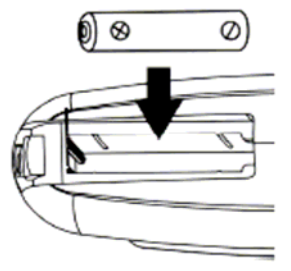

BATTERY PRECAUTIONS

Follow these precautions when using a battery in this device:

1. Use only the size and type of battery specified.
2. Be sure to follow the correct polarity when installing the battery as indicated in the battery compartment. A reversed battery may cause damage to the device.
3. Do not mix different types of batteries together (e.g. Alkaline and Carbon-zinc) or old batteries with fresh ones.
4. If the batteries in the device are consumed or the device is not to be used for a long period of time, remove the battery to prevent damage or injury from possible battery leakage.
5. Do not try to recharge the battery not intended to be recharged; it can overheat and rupture. (Follow battery manufacturer's directions.)
6. Do not dispose of batteries in fire. Battery may explodes or leak.
7. Clean the battery contacts and also those of the device prior to battery installation.

SETTING THE CLOCK

1. Make sure the unit is in STANDBY mode.

2. Press the "MEM/CLK-ADJ" button, the first two digits of the time (hours) "00" are flashing. Press "SKIP DOWN ◀◀ or UP ▶▶" button to set the correct hour. Press "MEM/CLK-ADJ" button to store the correct hour.
3. The third & fourth digits of the time (minutes) "00" are flashing, press the "SKIP DOWN ◀◀ or UP ▶▶" button to set the correct minutes. Press "MEM/CLK-ADJ" to store the correct minutes.
4. To select 12/24 hours display mode, press and hold the CD "STOP" button on main unit and then press the "MEM/CLK-ADJ" button to switch the clock between 12H (12 Hour) and 24H (24 Hour).

- Note:**
1. The pre-set time will need to be reset completely if the main power button on system is turned off. You are recommended to only switch the system into standby mode for convenience and also to avoid having to reset the time again.
 2. 12/24 hour format mode can only be set by control buttons on the main unit.

LISTENING TO RADIO

Manual Tuning

1. Press the POWER button to turn on the unit.
2. Press "TUNER/BAND" button and select the desired band (AM or FM).
3. Tune to the required radio station by pressing the "TUNING + / -" button on main unit or SKIP UP / DOWN on remote manually.
4. Adjust volume controls to the desired volume level.

Auto Tuning

1. Press "TUNER/BAND" button and select the desired band (AM or FM).
2. Press and hold the "TUNING + or -" button for 1-2 seconds and then release.
3. The unit will start seeking automatically and stop until a radio station is reached.
4. Repeat step 2-3 until the desired radio station is being reached.
5. Adjust volume controls to the desired volume level.

Preset Radio Stations

You can store up to total of 20 radio stations in the memory.

1. Set to TUNER mode
2. Turn to the desired radio station by "MANUAL" or "AUTO" tuning method.
3. Press "MEM/CLK-ADJ" button to enable program state.
4. Press "REPEAT/M-UP" button to select the desired station memory for storage.
5. Press "MEM/CLK-ADJ" button again to confirm the setting.
6. Repeat step 2 to 5 to store other stations if necessary.

Note:

1. The pre-set memories will be cancelled completely if switching off the main power button on system. You are recommended to switch the system into standby mode for convenience usage.
2. There are 5 seconds for program state, after 5 sec. this state would release to normal tuner mode automatically.
3. You can overwrite a present station by storing another frequency in its place.

Recall the Preset Stations

1. In AM or FM radio mode, press "M-UP" or "M-DN" button to select the preset stations in order.

FM & FM-Stereo reception

- Set the FM mode selector at "MONO" position. Programs are received in mono mode. In particular when stereo signals are weak. It is preferable to receive the program in mono.

- Set the FM mode selector at “ST” position for receiving stereo programs. The “ST” indicator will appear on LCD to show fm stereo program is receiving.

Hints for Best Reception:-

- AM: The receiver has a built-in AM bar antenna. If AM reception is weak, slight rotate or re-positioning of the unit will usually improve the AM reception.
- FM: The receiver has a built-in FM wire antenna hanging at the rear cabinet. This wire should be totally unraveled and extended from best reception.

STEREO PHONOGRAPH OPERATION

Note Before Use

- Remove the stylus protector.
- Be sure that the tone arm is being detached from the tone arm rest before operating, and re-secured again afterwards.

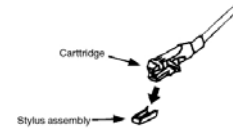

1. Raise the turntable dust cover.
2. Press the “PHONO” function button.
3. Set the 33/45/78 speed selector to the proper position depending on the record to be played.
4. Place the record on the platter (use the 45 RPM record adaptor when playing 45 RPM record).
5. Lift the tone arm from the rest and slowly move it to the record side. The platter will begin to rotate.
6. Place the tone arm to the desired position of the record.
7. Adjust the volume to the desired level.
8. At the end of record, the platter will automatically stop rotating. Lift the tone arm from the record and return it to the rest.
9. To stop manually, lift the tone arm from the record and return it to the rest.

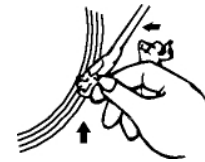

Remark: as some kind of record the auto-stop area was out of the unit setting, so it will stop before the last track finish. in this case, select the auto-stop switch to “OFF” position, then it will run to the end of the record but will not stop automatically (turn off the unit by power button or switch back the auto-stop switch to “ON” position to stop the platter rotate). Then put back the tone arm to the rest position.

PLAYING COMPACT DISC

● LOADING THE DISCS

1. Press “CD” button.
2. Press “OPEN/CLOSE” button to open the CD door.
3. Place a CD with the printed side facing up inside the tray.
4. Press the “ ” or “DISC-CH” button to turning the CD tray, and loading out the other disc compartment.
5. Press the “OPEN/CLOSE” button again to close the CD door.
6. CD search is performing; the display will show the total number of disc, number of tracks and playing time of disc.

Note: CD searching will be performed every time when switching to CD mode or closing the CD door. All CD functions will be responded only after the CD searching is completed.

● CD PLAY / PAUSE MODE

1. Press the “PLAY/PAUSE” button to start playback, the first track of the first disc will be played and the play indicator will appear on the LCD display.

2. or press either the “DISC 1”, “DISC 2”, “DISC 3” button, unit will play the disc inside the desire tray directly.
3. To interrupt, press the “PLAY/PAUSE” button once, and the display will start flashing. Press

again to resume playback.

● **STOP MODE ■**

1. If "STOP" button is pressed during PLAY or PAUSE mode, system will go to stop mode.

● **SKIP MODE (SKIP UP▶▶/SKIP DOWN◀◀)**

1. During PLAY or PAUSE mode, if "SKIP +" button is pressed it will go to next track and display the track no. and then remain the PLAY or PAUSE mode.
2. During PLAY or PAUSE mode, if "SKIP -" button is pressed. It will go back to the beginning of the track, original track no. is display and remains the play or pause mode.
3. After step 2, press "SKIP -" button again will go to the previous track and remain the play or pause mode.

● **SEARCH MODE (SEARCH UP▶▶▶/SEARCH DOWN◀◀◀)**

1. During PLAY mode, if "SEARCH +" button is pressed & hold for few seconds, it will start searching forward.
2. During play mode, if "SEARCH -" button is pressed & hold for few seconds, it will star searching backwards.

● **REPEAT PLAY**

This function allows to repeat 1 single track, 1 single disc or all discs:-
Press the "REPEAT" keys repeatedly to switch the function:-



Note: Single track repeat function is possible in normal or programmed playback, repeat one disc or all discs is only available in normal playback.

● **RANDOM PLAY**

You can listen all the tracks of all available discs in a random order by this function

1. Press "RANDOM" button once, unit will play all disc randomly; press again, unit will play 1 disc randomly.
2. Press "PLAY/PAUSE" button to start random playback.
3. All tracks of all discs or all tracks of 1 disc will be started playback in random order.
4. Press "RANDOM" button again to cancel random mode.

● **INTRO PLAY (BY REMOTE ONLY)**

You can listen the beginning (10 seconds) of each track in a CD by this function & saving your time to search the desire song

1. Press "INTRO" button after placing a CD inside the unit at CD mode
2. System start playing the first 10 seconds of each track of the entire CD continuously.
3. Press "INTRO" button once again when it reach your desired track for normal playback.

● **REMAIN FUNCTION (BY REMOTE ONLY)**

In CD playback mode, press to check the remain time on LCD display during CD playback

Press "REMAIN" button repeatedly to switch the function as below:

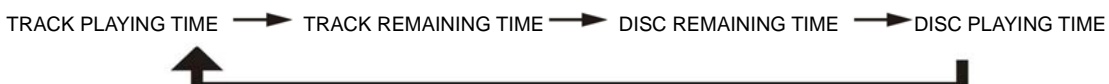

CD PROGRAMMING

Up to 60 tracks can be programmed to be programmed to be played in any required order from one CD or all CDs in the CD changer.

1. Set in CD mode and press the "STOP ■" button.
2. Press the MEM/CLK-ADJ button
3. Press the " (DISC) " to select the desired disc.
4. Press SKIP DOWN I◀◀ or UP ▶▶ button to select the desired track.
5. Press the "MEM/CLK-ADJ" button again to store the track in memory.
6. Repeat steps 2 to 5 to enter additional program
7. Press "PLAY/PAUSE" button to start playback in order.
8. Press "STOP ■" button to stop playback and press it twice to clear all programmed tracks.

LISTING TO TAPE

GENERAL OPERATION

STOP / EJECT KEY ■▲ Press to stop all deck operation. Press again to open the cassette door.

FAST FORWARD KEY ▶▶ & REWIND KEY ◀◀ Press to start rapid tape winding in either forward or reverse direction. Press stop / eject key when the cassette spools stop turning.

PLAY KEY ▶ Press to start playing tape.

PAUSE KEY || Press to stop tape operation temporarily. Press again to resume.

RECORD KEY ● (DECK 1 ONLY) Press together with play key to start tape recording.

PLAYBACK

- Press "TAPE" button to active tape function
- Put in the cassette tape.
- Press PLAY key to active playback
- Adjust the volume control to the desired level.
- Use PAUSE key when you want to stop playback temporarily.
- Press STOP / EJECT key when finished.

RECORDING

This cassette recorder features an Automatic Recording Volume Level Control System that prevents overloaded or distorted recordings. You can change the volume level as often as you like during the recording process. It will not have any effect on the volume level of the recording itself.

Insert a good quality blank tape into DECK A with the exposed tape facing down and the full reel on the left side. Close DECK A door.

A. RECORDING FROM TAPE (DECK B TO DECK A)

This unit enables you to duplicate a pre-recorded tape to another tape. It is performed only one way from deck B (playback) to deck A (recording).

DUBBING AT NORMAL SPEED

- Press the "TAPE" function button.
- Insert a pre-recorded cassette into deck B and a blank cassette tape into deck A.
- Press the "PAUSE" key and then press the "RECORD" and "PLAY" key at deck A.
- Press the "PLAY" key to start playback at deck B and then release "PAUSE" key at deck A to start dubbing.
- Press "PAUSE" key at deck A and "STOP" key at deck B when finish.

DUBBING AT HIGH SPEED

This unit is equipped with a high speed dubbing system which can save the time for dubbing by 2/3 when compare to normal speed.

- Press the dubbing button to "HI" position and then follow the same procedures as stipulated in "dubbing at normal speed".
- When dubbing a pre-recorded cassette tape at high speed, a chattering sound is being heard. to avoid this, set the volume control to a minimum level.
- Do not active/de-active the "Hi-Nor Dubbing" button during dubbing, this will vary the speed of recording and may be damage the cassette tape.

B. RECORDING FROM RADIO

- Press "RADIO" button to active radio mode
- Tune to the desired station and insert a blank cassette tape in deck A.
- Press "RECORD" & "PLAY" key to start recording.
- Press "PAUSE" keys and then "STOP/EJECT" key when finish.

NOTE: During recording of AM, beating whistle at some reception stations may happen, by selecting "BEAT CUT 1-2" switch may help to reduce the background noise.

C. RECORDING FROM CD

- Press the "CD" function button.
- Insert a blank cassette tape in deck A which suitable for recording.
- Press "PAUSE" key first and then "RECORD" & "PLAY" key at cassette. Recording function is now on STANDBY.
- Activate the CD player, and then press "PAUSE" at cassette to start recording.
- To stop recording, press "STOP" button on CD player first, then press the "PAUSE" key and then "STOP/EJECT" key on cassette tape deck.

15

D. RECORDING FROM PHONO

- Press the "PHONO" function button.
- Place a record onto turntable and insert a blank cassette tape into deck A.
- Press the "PAUSE" key and then press the "RECORD" and "PLAY" key at deck A.
- Place tone arm to start playback the record and then release "PAUSE" key at deck A to start dubbing.
- Press "PAUSE" or "STOP" key at deck A when finish.

MORE FEATURES

A. SLEEP TIMER SETTING

1. Press and hold the "SLEEP/TIMER" button on main unit or "SLEEP" button on remote, to active and adjust the sleep timer in the order of 90 > 80 >70....10 minutes automatically. Release the button at sleep timer you want to select.
2. System will stop and go to STANDBY mode automatically after the selected timing.
3. To cancel the sleep mode, press the "SLEEP/TIMER" button on main unit or "SLEEP" on the remote once, "SLEEP" indicator on the display disappears.

B. ON/OFF TIMER SETTING (BY REMOTE ONLY)

This function allows the system to turn on automatically and wake you up by soft CD music or radio and shut off itself into standby mode when time is up.

1. In unit standby mode, press the "MODE" button on remote once, the LCD display will show "⌚ON" timer icon and flashing.
2. Press "MEM/CLOCK-ADJ" button and then "SKIP UP/ DOWN" to set the hour.
3. Press "MEM/CLOCK-ADJ" button to confirm. Minute digits are flashing and prompt for input.
4. Press the "SKIP UP/ DOWN" button to set the minute.
5. Press "MODE" button to store the timer starting time. "⌚ OFF" timer will appear and flashing.
6. Follow above step 2-4 to set OFF timer.
7. Press the "MODE" button to confirm, "⌚" icon flash and timer source CD/PHONO/TUNER/TAPE appears on the display.
8. Press the "MEM/CLOCK-ADJ" button once, timer source flashing.
9. Press the "SKIP UP/ DOWN" to set source to be controlled by timer and then press the "MODE" button to finish.
10. You can press the "MODE" button repeatedly to review the presets time in order.

- NOTE:**
1. The timer setting will automatically cancel if no button is being pressed in a period of about 10 seconds.
 2. If you set ON/OFF timer for PHONO or TAPE, please make sure record or pre-recorded tape is installed and tone arm or cassette PLAY key is set and ready to play.

● ACTIVE/DE-ACTIVE TIMER FUNCTION

1. To active the ON/OFF timer, press the "SLEEP/TIMER" button on main unit or "TIMER" button on remote once, the timer indicator ⌚ is shown on LCD
2. To cancel ON/OFF timer function, press again "SLEEP/TIMER" button until the timer indicator "⌚" disappear

16

C. PRESETS EQ FUNCTION

This unit provides 5 differences sound mode to enhance your listening experience. You can select the desired effect by pressing the "EQ" button repeatedly at following sequence:-

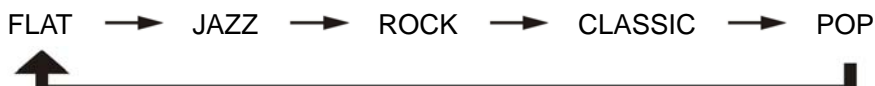

D. EXTRA BASS FUNCTION

Press down the "Xbass" switch on main unit if you want more bass effect when listening. Press it again to turn off extra bass effect.

E. MUTE FUNCTION

Press to terminate the sound output from system temporarily and press again to cancel this mode.

F. HEADPHONE JACK

Inserting the plug of your headphones (not included) into the Headphone jack will enable you to listen in private. When using headphones, the speakers will be disconnected.

READ THIS IMPORTANT INFORMATION BEFORE USING YOUR HEADPHONES

1. Avoid extended play at very high volume as it may impair your hearing.
2. If you experience ringing in your ears, reduce the volume or shut off your unit.
3. Keep the volume at a reasonable level even if your headset is an open-air type designed to allow you to hear outside sounds. Please note that excessively high volume may still block outside sounds.

CARE AND MAINTENANCE

1. Do not subject the unit to excessive force, shock, dust or extreme temperature.
2. Do not tamper the internal components of the unit.
3. Clean your unit with a dry cloth. Solvent or detergent should never be used.
4. Avoid leaving your unit in direct sunlight or in hot, humid or dusty places.
5. Keep your unit away from heating appliances and sources of electrical noise such as fluorescent lamps or motors.

ABOUT CASSETTE TAPES

Whenever you record on a cassette any previously recorded material is erased as the new material is recorded. To prevent you from accidentally erasing material which you wish to save, blank cassettes are equipped with erase prevention tabs for each side of the tape. If the erase prevention tab for side A is removed, you cannot accidentally record on side A. The Record ● key cannot be depressed if the erase prevention tab on the cassette has been removed.

To prevent accidental erasing on side A of a cassette use a small screw driver or similar tool to

break off the erase prevention tab for side A. This prevents the record key from locking.

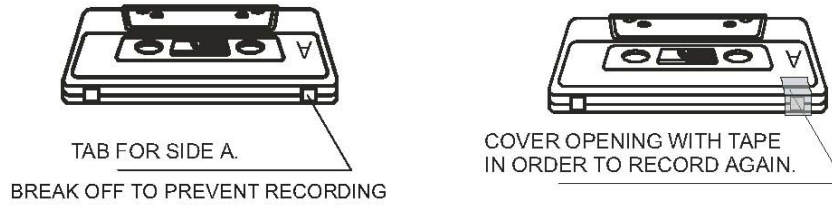

If later you do wish to record on side A of the cassette, cover the tab opening with a piece of cellophane tape. This will allow the Record ● to function again.

CASSETTE CARE

Two common causes of trouble experienced when using cassettes are:

- 1) Tape Jamming – Leading to uneven speed in playback, and
- 2) Tape Tangling – Where the tape wraps itself around vital parts of the mechanism.

To reduce the likelihood of these problems occurring, the following precautions should be observed:

- Check that there are no loose layers of tape visible through the cassette center window (see Fig. 1). Take up any loose layers, using a pencil or hexagonal barrelled ballpoint pen, before inserting the cassette into the machine (see Fig.2)

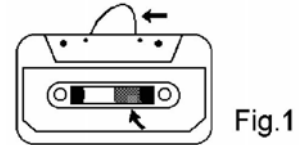

- If the cassette feels tight while performing operation shown (see Fig.2), the tape may be jamming due to ridges formed in the winding of the tape (visible through the center window). These may be removed, in most cases, by fast winding of the cassette from one end to the other and back again.

- Use only well-known brands of tape. Avoid use of C-120 cassettes.

Furthermore, do not expose cassettes to direct sunlight, dust or oil, and do not touch the tape surfaces.

HEAD CLEANING

The tape heads, pinch roller and capstan require periodic cleaning. This removes particles of the metal oxide coating that wear off the tape and accumulate on these parts and impair performance. Switch off the power, press the Stop/Eject ■▲ key to open the cassette door, and press the Play ► key. Clean the tape heads, pinch roller and capstan with a soft cloth or cotton pad dampened in isopropyl alcohol or special tape head cleaner.

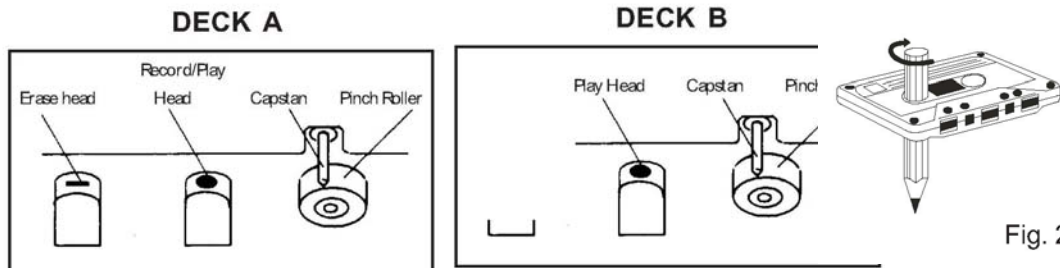

1. Avoid operating your unit under direct sunlight or in hot, humid or dusty places.

2. Keep your unit away from heating appliances and sources of electrical noise such as fluorescent lamps or motors.
3. For better Clock Display clarity, avoid operating the unit under direct sunlight or in strong room illumination.
4. Unplug the unit from the electrical power outlet immediately in case of malfunction.

COMPACT DISC CARE

- Handle the disc only by its edges. Never allow your fingers to come in contact with the shiny, unprinted side of the disc.
- Do not attach adhesive tape, stickers etc., to the disc label.
- Clean the disc periodically with soft, lint-free, dry cloth. Never use detergents or adhesive cleaners to clean the disc. If necessary, use a CD cleaning kit.
- If disc skips or gets stuck on a section of the disc, it is probably dirty or damaged (scratched).
- When cleaning the disc, wipe in straight lines from the center of the disc to the edge of the disc. Never wipe in circular motions.
- To remove a disc from its storage case, press down on the center of the case and lift the disc out, holding it carefully by the edges.
- Fingerprints and dust should be carefully wiped off the disc's recorded surface with a soft cloth. Unlike conventional records, compact discs have no grooves to collect dust and microscopic debris so gently wiping with a soft cloth should remove most particles.

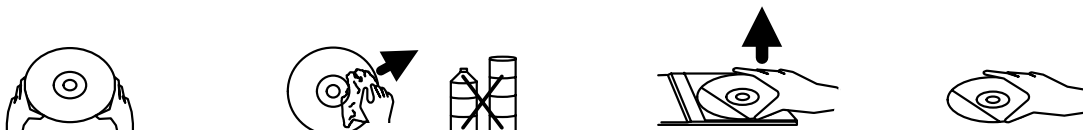

CLEANING THE UNIT

- To prevent fire or shock hazard, disconnect your unit from the AC power source when cleaning.
- The finish on the unit may be cleaned with a dust cloth and cared for as other furniture, Use caution when cleaning and wiping the plastic parts.
- If the cabinet becomes dusty wipe it with a soft dry dust cloth. Do not use any wax or polish sprays on the cabinet.
- If the front panel becomes dirty or smudged with fingerprints it may be cleaned with a soft cloth slightly dampened with a mild soap and water solution. Never use abrasive cloths or polishes as these will damage the finish of your unit.

CAUTION: Never allow any water or other liquids to get inside the unit while cleaning.

PROBLEM	POSSIBLE CAUSE	SOLUTION
The unit does not respond (no power)	The unit is disconnected from the AC outlet	Reconnect to the AC outlet.
	AC outlet is not functioning.	Plug another device into the same outlet to confirm the outlet is working.
AM band is too noisy	The reception at the set location is poor.	Slightly rotate the unit for the best reception.
Radio paused about 1 second when switch from phonograph mode to tuner mode	This is normal.	Radio will resume normal function in 1-2 seconds.
Sound is distorted	Volume level is set to high.	Decrease the volume.
	Sound source is distorted.	Try a different audio source such as a music CD.
CD Player does not play.	CD Mode is not selected.	Slide the FUNCTION switch to select CD mode.
	CD is not installed or installed incorrectly.	Press the CD onto spindle, printed side facing up.
CD skip while playing	Disc is dirty or scratched.	Wipe with cloth or another disc.
Unit gets warm after extended play at high volume	This is normal	Turn the unit off for a period of time or lower volume.

Power Requirement

Main unit: AC120V~ 60Hz
Remote control 2 x 1.5V "AAA" (UM-4) size batteries (not included)

Frequency Range

Radio Band FM 88 ~ 108 MHz
AM 520 ~ 1710 KHz

Power Consumption

Main Unit: 35Watts

SERVICE

Please refer to the instructions on the enclosed warranty card for returning your unit for service. When returning the unit, please remove the battery to prevent damage to the unit in transit and/or from possible battery leakage. We are not responsible for battery returned with the product or for the cost of replacement.

Distributed by:

Spectra Merchandising International, Inc.

Chicago Industry Tech Park

4230 North Normandy Avenue

Chicago, IL 60634, U.S.A.

Please have model number ready, for Customer Service, call 1-800-777-5331

The specification and external appearance of the set are subject to change without prior notice.

Printed in China

Free Manuals Download Website

<http://myh66.com>

<http://usermanuals.us>

<http://www.somanuals.com>

<http://www.4manuals.cc>

<http://www.manual-lib.com>

<http://www.404manual.com>

<http://www.luxmanual.com>

<http://aubethermostatmanual.com>

Golf course search by state

<http://golfingnear.com>

Email search by domain

<http://emailbydomain.com>

Auto manuals search

<http://auto.somanuals.com>

TV manuals search

<http://tv.somanuals.com>