

# ET-3302-J 7-INCH GRINDER



JOHN DEERE

OPERATOR'S  
MANUAL



**CAUTION**  
**RISK OF INJURY!**  
READ MANUAL BEFORE OPERATING!  
THIS MANUAL IS AN IMPORTANT PART OF THE DISC GRINDER  
AND SHOULD REMAIN WITH THIS UNIT WHEN YOU SELL OR RENT IT.

# Introduction

Congratulations on the purchase of your new disc grinder! You can be assured your grinder was constructed and designed with quality and performance in mind. Each component has been rigorously tested to ensure the highest level of acceptance.

This operator's manual was compiled for your benefit. By reading and following the simple safety, installation, operation, maintenance and troubleshooting steps described in this manual, you will receive years of trouble-free operation from your new tool. The contents of this manual are based on the latest product information available at the time of publication. The manufacturer reserves the right to make changes in price, color, materials, equipment, specifications or models at any time without notice.

Once the unit has been removed from the box, immediately write in the serial number of your unit in the space provided below.

**SERIAL NUMBER** \_\_\_\_\_

Inspect for signs of obvious or concealed freight damage. If damage does exist, file a claim with the transportation company immediately. Be sure that all damaged parts are replaced and that the mechanical problems are corrected prior to operation of the unit. If you require service, contact your Customer Service.

Mi-T-M® Corporation, 8650 Enterprise Drive, Peosta, IA 52068  
1-877-JD-KLEEN / (1-877-535-5336) Fax 563-556-1235  
Monday - Friday 8:00 a.m. - 5:00 p.m. CST

Please have the following information available for all service calls:

1. Model Number
2. Serial Number
3. Date and Place of Purchase

## **WARNING**

### **WEAR RESPIRATORY PROTECTION**

Some dust created by power sanding, sawing, grinding, drilling and other construction activities contain chemicals known to the State of California to cause cancer, birth defects or other reproductive harm. Some examples of these chemicals are:

- Lead from lead-base paints,
- Crystalline Silica from bricks, cement and other masonry products, and
- Arsenic and Chromium from chemically-treated lumber.

Your risk from these exposures varies, depending on how often you do this type of work. To reduce your exposure to these chemicals, work in a well ventilated area and work with approved safety equipment, such as those dust masks that are specially designed to filter out microscopic particles.

# Table of Content

<b>SAFETY</b> .....	<b>4-10</b>
GENERAL SAFETY RULES .....	4-10
<b>FUNCTIONAL DESCRIPTION</b> .....	<b>11</b>
MODEL .....	11
NAME OF PARTS .....	11
SPECIFICATIONS .....	11
<b>ASSEMBLY</b> .....	<b>12</b>
<b>OPERATION</b> .....	<b>13-15</b>
APPLICATIONS .....	13
PRE-OPERATION .....	13-14
OPERATION .....	14-15
<b>MAINTENANCE AND INSPECTION</b> .....	<b>16-17</b>
MAINTENANCE AND INSPECTION .....	16
SERVICE AND REPAIRS .....	17
STANDARD ACCESSORIES .....	17
<b>NOTES</b> .....	<b>18-19</b>

# Safety

## RECOGNIZE SAFETY INFORMATION

This is the safety alert symbol. When you see this symbol on your tool or in this manual, be alert to the potential for personal injury.

Follow recommended precautions and safe operating practices.



## UNDERSTAND SIGNAL WORDS

A "DANGER, WARNING or CAUTION" safety warning will be surrounded by a "SAFETY ALERT BOX." This box is used to designate and emphasize Safety Warnings that must be followed when operating this tool.

Accompanying the Safety Warnings are "signal words" which designate the degree or level of hazard seriousness. The "signal words" used in this manual are as follows:

**DANGER:** Indicates an imminently hazardous situation which, if not avoided, WILL result in death or serious injury.

**WARNING:** Indicates a potentially hazardous situation which, if not avoided, COULD result in death or serious injury.

**CAUTION:** Indicates a potentially hazardous situation which, if not avoided MAY result in minor or moderate injury.

**▲ DANGER**

**▲ WARNING**

**▲ CAUTION**

## GENERAL SAFETY RULES



**WARNING:** Read and understand all instructions. Failure to follow all instructions listed below, may result in electric shock, fire and/ or serious personal injury.



**SAVE THESE INSTRUCTIONS**



## **WARNING**

### **NEVER TOUCH MOVING PARTS**

Never place your hands, fingers or other body parts near the tool's moving parts.

### **NEVER OPERATE WITHOUT ALL GUARDS IN PLACE**

Never operate this tool without all guards or safety features in place and in proper working order. If maintenance or servicing requires the removal of a guard or safety feature, be sure to replace the guard or safety feature before resuming operation of the tool.

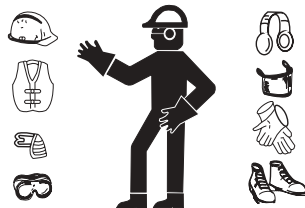

### **ALWAYS WEAR EYE AND EAR PROTECTION**

Protect yourself from flying or expelled wood chips, metal particles or other debris by using protective goggles or equivalent eye protector. Wear ear protector to protect yourself from excessive noise.

### **PROTECT YOURSELF AGAINST ELECTRIC SHOCK**

Prevent body contact with grounded surfaces such as pipes, radiators, ranges and refrigeration enclosures. Never operate the tool in damp or wet locations.

### **DISCONNECT TOOLS**

Never leave the tool connected to a power source. Always disconnect the tool from its power source before servicing, inspecting, maintaining, cleaning and before changing or checking any parts.

### **AVOID UNINTENTIONAL STARTING**

Don't carry the tool while it is connected to its power source. Don't carry the tool with your finger near the power switch. Be sure the power switch is in the "off" position before connecting the tool to its power source.

### **CONSIDER WORK AREA ENVIRONMENT**

Don't expose power tools to rain. Don't use power tools in damp or wet locations. Keep work area well lit and well ventilated.

Don't use tool in presence of flammable liquids or gases.

Power tools produce sparks during operation. They also spark when switching ON/OFF. Never use power tools in sites containing lacquer, paint, benzine, thinner, gasoline, gases, adhesive agents, and other materials which are combustible or explosive.

### **KEEP CHILDREN AWAY**

Do not let visitors contact tool or extension cord. All visitors should be kept safely away from work area.



## **WARNING**

### **DRESS PROPERLY**

Do not wear loose clothing or jewelry. They can be caught in moving parts. Rubber gloves and non-skid footwear are recommended when working outdoors. Wear protective hair covering to contain long hair.

### **USE FACE, DUST MASK OR RESPIRATOR IF OPERATION IS DUSTY**

All persons in the area where power tools are being operated should also wear face, dust mask or respirator.

### **SECURE WORK**

Use clamps or a vise to hold work. It's safer than using your hand and it frees both hands to operate tool.

### **DON'T OVERREACH**

Keep proper footing and balance at all times.

### **STAY ALERT**

Watch what you are doing. Use common sense. Do not operate tool when you are tired.

Tools should never be used by you if you are under the influence of alcohol, drugs or medication that makes you drowsy.

### **HANDLE TOOL CORRECTLY**

Operate the tool according to the instructions provided herein. Do not drop or throw the tool. Never allow the tool to be operated by children, individuals unfamiliar with its operation or unauthorized personnel.

### **CHECK FOR LIVE WIRES**

Avoid the risk of severe electrical shock by checking for live electrical wires that may be buried in walls, floors or ceilings. The circuit to the wires should be disconnected before work begins.

### **DO NOT USE POWER TOOLS IF THE PLASTIC HOUSING OR HANDLE IS CRACKED**

Cracks in the tool's housing or handle can lead to electric shock. Such tools should not be used until repaired.

### **BLADES AND ACCESSORIES MUST BE SECURELY MOUNTED TO THE TOOL**

Prevent potential injuries to yourself or others. Blades, cutting implements and accessories which have been mounted to the tool should be secure and tight.

### **NEVER LEAVE TOOL RUNNING UNATTENDED**

Turn power off. Don't leave tool until it comes to a complete stop.



## CAUTION

### **STORE TOOL PROPERLY**

When not in use, the tool should be stored in a dry place. Keep out of reach of children. Lock-out the storage area.

### **KEEP WORK AREA CLEAN**

Cluttered areas and benches invite injuries. Clear all work areas and work benches of unnecessary tools, debris, furniture, etc.

### **DON'T FORCE TOOL**

It will do the job better and safer at the rate for which it was intended.

### **USE RIGHT TOOL**

Don't force small tool or attachment to do the job of a heavy-duty tool. Don't use tool for purpose not intended—for example— don't use circular saw for cutting tree limbs or logs.

### **DON'T ABUSE CORD**

Never carry tool by cord or yank it to disconnect from receptacle. Keep cord from heat, oil and sharp edges.

### **SECURE WORK**

Use clamps or a vise to hold work. It's safer than using your hand and it frees both hands to operate tool.

### **MAINTAIN TOOLS WITH CARE**

Keep tools sharp and clean for better and safer performance. Follow instructions for lubricating and changing accessories. Inspect tool cords periodically and if damaged, have repaired by an authorized dealer. Inspect extension cords periodically and replace if damaged. Keep handles dry, clean, and free from oil and grease.

### **REMOVE ADJUSTING KEYS AND WRENCHES**

Keys and adjusting wrenches remove from tool before turning it on.

### **OUTDOOR USE EXTENSION CORD**

When tool is used outdoors, use only extension cord intended for use outdoors and so marked.

### **CHECK DAMAGED PARTS**

Before further use of the tool, a guard or other part that is damaged should be carefully checked to determine that it will operate properly and perform its intended function.

Check for alignment of moving parts, binding of moving parts, breakage of parts, mounting, and any other conditions that may affect its operation.

A guard or other part that is damaged should be properly repaired or replaced by an authorized dealer unless otherwise indicated elsewhere in this Instruction Manual. Have defective switches replaced by the authorized dealer. Do not use tool if switch does not turn it on and off.

### **NEVER USE A POWER TOOL FOR APPLICATIONS OTHER THAN THOSE SPECIFIED**

Never use a power tool for applications other than those specified in the Instruction Manual.



## CAUTION

### **HANDLE TOOL CORRECTLY**

Operate the tool according to the instructions provided herein. Do not drop or throw the tool. Never allow the tool to be operated by children, individuals unfamiliar with its operation or unauthorized personnel.

### **KEEP ALL SCREWS, BOLTS AND COVERS TIGHTLY IN PLACE**

Keep all screws, bolts, and plates tightly mounted. Check their condition periodically.

### **KEEP MOTOR AIR VENT CLEAN**

The tool's motor air vent must be kept clean so that air can freely flow at all times. Check for dust build-up frequently.

### **OPERATE POWER TOOLS AT THE RATED VOLTAGE**

Operate the power tool at voltages specified on its nameplate.

If using the power tool at a higher voltage than the rated voltage, it will result in abnormally fast motor revolution and may damage the unit and the motor may burn out.

### **NEVER USE A TOOL WHICH IS DEFECTIVE OR OPERATING ABNORMALLY**

If the tool appears to be operating unusually, making strange noises, or otherwise appears defective, stop using it immediately and arrange for repairs by a JOHN DEERE AUTHORIZED DEALER.

### **CAREFULLY HANDLE POWER TOOLS**

Should a power tool be dropped or struck against hard materials inadvertently, it may be deformed, cracked, or damaged.

### **DO NOT WIPE PLASTIC PARTS WITH SOLVENT**

Solvents such as gasoline, thinner benzine, carbon tetrachloride, and alcohol may damage and crack plastic parts. Do not wipe them with such solvents.

Wipe plastic parts with a soft cloth lightly dampened with soapy water and dry thoroughly.

### **USE ONLY GENUINE JOHN DEERE REPLACEMENT PARTS**

Replacement parts not manufactured by JOHN DEERE may void your warranty and can lead to malfunction and resulting injuries. Genuine JOHN DEERE parts are available from your dealer.

### **POLARIZED PLUGS**

To reduce the risk of electric shock, this equipment has a polarized plug (one blade is wider than the other).

This plug will fit in a polarized outlet only one way.

If the plug does not fit fully in the outlet, reverse the plug.

If it still does not fit, contact a qualified electrician to install the proper outlet.

Do not change the plug in any way.

### **USE ONLY GRINDING WHEELS HAVING A MAXIMUM OPERATING SPEED AT LEAST HIGH AS 6600 RPM.**





## CAUTION

### USE OF EXTENSION CORD

Make sure your extension cord is in good condition. When using an extension cord, be sure to use one heavy enough to carry the current your product will draw.

An undersized cord will cause a drop in line voltage resulting in loss of power and overheating. Table shows the correct size to use depending on cord length and nameplate ampere rating. If in doubt, use the next heavier gage. The smaller the gage number, the heavier the cord.

#### MINIMUM GAGE FOR CORD SETS

##### Total Length of Cord in Feet (Meter)

		0 – 25 (0 – 7.6)	26 – 50 (7.9 – 15.2)	51 – 100 (15.5 – 30.5)	101 – 150 (30.8 – 45.7)
Ampere	Rating	AWG			
More	Not More				
Than	Than				
		18	16	16	14
		18	16	14	12
		16	16	14	12
		14	12	Not Recommended	



**WARNING: AVOID ELECTRICAL SHOCK HAZARD. NEVER USE THIS TOOL WITH A DAMAGED OR FRAYED ELECTRICAL CORD OR EXTENSION CORD. INSPECT ALL ELECTRICAL CORDS REGULARLY. NEVER USE IN OR NEAR WATER OR IN ANY ENVIRONMENT WHERE ELECTRIC SHOCK IS POSSIBLE.**

### DOUBLE INSULATION FOR SAFER OPERATION

To ensure safer operation of this power tool, JOHN DEERE has adopted a double insulation design. “Double insulation “ means that two physically separated insulation systems have been used to insulate the electrically conductive materials connected to the power supply from the outer frame handled by the operator. Therefore, either the symbol  or the words “Double insulation” appear on the power tool or on the nameplate.

Although this system has no external grounding, you must still follow the normal electrical safety precautions given in this Instruction Manual, including not using the power tool in wet environments.

To keep the double insulation system effective, follow these precautions:

- a. Only a AUTHORIZED JOHN DEERE DEALER should disassemble or assemble this power tool, and only genuine JOHN DEERE replacement parts should be installed.
- b. Clean the exterior of the power tool only with a soft cloth moistened with soapy water, and dry thoroughly. Never use solvents, gasoline or thinners on plastic components; otherwise the plastic may dissolve.



## **IMPORTANT**

### **IMPORTANT SAFETY INSTRUCTIONS FOR USE OF THE DISC GRINDER**



**WARNING: DEATH OR SERIOUS BODILY INJURY COULD RESULT FROM IMPROPER OR UNSAFE USE OF THE DISC GRINDER.**

1. NEVER operate the disc grinder without its wheel guard in place.
2. NEVER place hands or body parts near the disc during operation.
3. NEVER use a grinding wheel which is cracked or deformed or worn away.
4. NEVER use a grinding wheel with an RPM rating which is less than 6600 RPM. The wheel can disintegrate during use and cause severe injuries.
5. NEVER use the grinder in places where the sparks generated by the grinder can cause explosion, such as where flammable materials or gases are present.
6. ALWAYS wear eye protection that meets the requirement of the latest revision of ANSI Standard Z87.1.
7. ALWAYS wear a mask or respirator to protect yourself from dust or potentially harmful particles generated during the grinding operation.
8. ALWAYS firmly grip the body handle and side handle while operating the grinder.
9. ALWAYS follow the instructions contained in this manual when replacing the grinding wheel.

#### **REPLACEMENT PARTS**

When servicing use only identical replacement parts.

Repairs should be conducted only by an AUTHORIZED JOHN DEERE DEALER.

**SAVE THESE INSTRUCTIONS AND MAKE THEM AVAILABLE TO OTHER USERS AND OWNERS OF THIS TOOL!**

# Functional Description

**MODEL:**  
ET-3302-J 7-INCH DISC GRINDER

**NOTE:** *The information contained in this Instruction Manual is designed to assist you in the safe operation and maintenance of the power tool.*

NEVER operate, or attempt any maintenance on the tool unless you have first read and understood all safety instructions contained in this manual.

Some illustrations in this Instruction Manual may show details or attachments that differ from those on your own power tool.

## NAME OF PARTS:

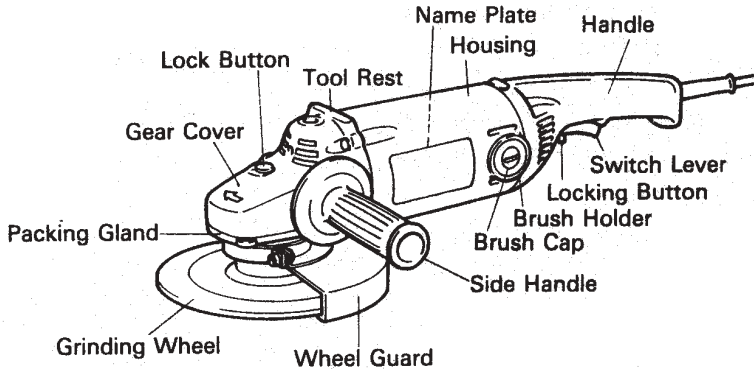

(Fig. 1)

## SPECIFICATIONS:

7-INCH DISC GRINDER ET-3302-J:

Motor	Single-Phase Series; Wound Commutator Motor
Power Source	Single-Phase 115V AC 60Hz
Input	1, 640W
No-Load Speed (USA)	6, 000 rpm
No-Load Speed (Canada)	8, 500 rpm
Wheel Size	
external diam.	7" (180mm)
internal diam.	7/8" (22mm)
Sanding Disc Size	
external diam.	7" (180mm)
internal diam.	7/8" (22mm)
Spindle Thread	5/8"-11UNC
Weight	11 lbs. (5.0kg)

# Assembly

## ASSEMBLY:



**WARNING: BE SURE TO SWITCH POWER OFF AND DISCONNECT THE PLUG FROM THE RECEPTACLE TO AVOID SERIOUS TROUBLE.**

### 1. Assembling:

- a. Turn the disc grinder upsidedown so that the spindle is facing upward.
- b. To mount the wheel guard on the grinder first, slip the set ring (A) over the guard mounting flange, so locating pin fits in the guard locating groove, then twist guard in the groove into a proper angle, so the guard will protect the operator's body from injury by a broken wheel piece.
- c. Tighten the screw in the set ring (A) of guard.
- d. To mount a grinding wheel on the grinder, first align the oval-shaped indentation of the wheel washer with the notched part of the spindle, then attach them.
- e. Fit the protuberance of the grinding wheel onto the wheel washer.
- f. Screw the wheel nut onto the spindle.
- g. While pushing the lock button with one hand, lock the spindle by turning the grinding wheel slowly with the other hand.
- h. Tighten the wheel nut by using the supplied wrench as shown in Fig. 2.

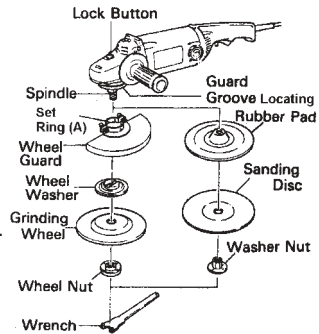

(Fig. 2)

### 2. For use as a sander:

- a. After placing the Sanding disc on the rubber pad, insert the washer nut through the spindle.
- b. While pushing the lock button with one hand, lock the spindle by turning the sanding disc slowly with the other hand.
- c. Secure the sanding disc and rubber pad by tightening the washer nut with the wrench.



**CAUTION: MAKE SURE THAT THE GRINDING WHEEL, THE SANDING DISC OR RUBBER PAD ARE MOUNTED FIRMLY.**

### 3. Disassembling:

To remove the wheel guard, the grinding wheel, the sanding disc, follow the above-mentioned procedure in reverse order.

# Operation

## APPLICATIONS:

### FOR USE AS A GRINDER:

- Removal of casting fin and finishing of various types of steel, bronze and aluminum materials and castings.
- Grinding of welded sections or sections cut by means of welding.
- Grinding of synthetic resins, slate, brick, marble, etc.

### FOR USE AS A SANDER:

- Preliminary sanding of metal surfaces before painting, rust removal, removing oil paint before repainting.
- Finishing woodwork, correcting projections of timbers from joints or assemblies.
- Preliminary sanding of wood surfaces before applying paint.

## PRE-OPERATION:

1. Power source:  
Ensure that the power source to be utilized conforms to the power source requirements specified on the product nameplate.
2. Power switch:  
Ensure that the switch is in the OFF position. If the plug is connected to a receptacle while the switch is in the ON position, the power tool will start operating immediately and can cause serious injury.
3. Extension cord:  
When the work area is far away from the power source, use an extension cord of sufficient thickness and rated capacity. The extension cord should be kept as short as possible.
4. Check the receptacle:  
If the receptacle only loosely accepts the plug, the receptacle must be repaired. Contact a licensed electrician to make appropriate repairs. If such a faulty receptacle is used, it may cause overheating, resulting in a serious hazard.
5. Check your working environment:  
Ensure the following before operation;
  - a. No flammable gas, liquid, or object at worksite.
  - b. Grinding thin steel sheet may cause a high booming sound. In this case, place a rubber mat under the workpiece.
  - c. Take appropriate noise preventive measures to prevent adverse affects on the environment by electrical noise.
  - d. Clear the area of children or unauthorized personnel.
6. Mounting the wheel guard:  
Be sure to mount the wheel guard at an angle that will protect the operator's body from injury by a broken wheel piece.



**WARNING: IF NOT CORRECTLY ATTACHING A PROPER WHEEL GUARD, IT MAY LEAD TO SEVERE INJURY OR DEATH IF THE GRINDING WHEEL SHOULD BE BROKEN.**

7. Inspect the grinding wheel carefully before mounting:  
Thoroughly check that a specified grinding wheel free of cracks and splits is mounted. Make sure that the grinding wheel is firmly clamped and has been mounted in accordance with the instructions contained on page 12.

# Operation

## PRE-OPERATION (CONTINUED):

8. Test the grinder before using:  
Before actually beginning the grinding work, test the grinder by first clearing the area of all other personnel. Make sure the wheel guard is in place and that you are wearing eye protection. Turn the grinder "on", and make sure the grinder runs smoothly and shows no abnormalities.  
Duration of the trial run is as follows:

When grinding wheel is replaced	3 minutes or more
When starting daily work	1 minute or more
9. Use only properly rated grinding wheels:  
Use only grinding wheels rated at 6600 RPM or more.  
Using a grinding wheel rated less can lead to wheel disintegration during operation and serious bodily injury.
10. Check the spindle lock:  
Make sure that the lock button is disengaged by pushing lock button two or three times before turning on the grinder.
11. Switch Operation:  
This enables the grinder always to be controlled with the hand gripping the machine for maximum safety during grinding operations.

### INTERMITTENT USE:

- |             |                           |
|-------------|---------------------------|
| Switch ON:  | Press the switch lever    |
| Switch OFF: | Release the switch lever. |

### CONTINUOUS USE:

- |             |  |
|-------------|--|
| Switch ON:  | Press the switch lever. The switch is locked by pulling the lock button. |
| Switch OFF: | Press and release the switch lever.                                      |

## OPERATION:

1. Always hold the handle and side handle of the POWER TOOL firmly. Otherwise the counterforce produced may result in inaccurate and even dangerous operation.
2. Grinding Pressure:  
Since grinding by utilizing only the Disc Grinder's own weight is feasible, hold the Disc Grinder so that it only slightly contacts the plane to be ground.



**CAUTION: DO NOT PRESS THE DISC GRINDER FORCIBLY AGAINST THE PLANE TO BE GROUND. HEAVY PRESSURE WILL REDUCE THE REVOLVING SPEED AND SUCH DETERIORATE THE FINISHED SURFACE, AND PHENOMENA AS OVERLOAD WILL LEAD TO BURNING LOSS OF THE MOTOR.**

# Operation

## OPERATION (CONTINUED):

### 3. Grinding angle:

Use only its peripheral surface by tilting the grinding wheel at an angle of  $15^{\circ}$  -  $30^{\circ}$ , as shown in Fig. 3-a.



**CAUTION: DO NOT UTILIZE THE ENTIRE SURFACE OF GRINDING WHEEL WHEN GRINDING.**

4. When using a new grinding wheel in direction A (Fig. 3-a), the wheel edge may cut into the workplace. In this case, grind in direction B (Fig. 3-a). Once the wheel edge is worn, the workpiece can be ground in both directions.

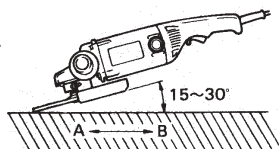

(Fig. 3-a)

The provided grinding wheel (resinoid wheel) is rated as class A grain and #24 grain size. Therefore, it is most appropriate for heavy grinding of general steel materials. It is also suitable for grinding other types of materials. For a fine finish, lift the disc grinder slightly and grind slowly at the appropriate speed.

### 5. Precaution after use:

Do not lay the grinder down immediately after use in a place where there are many shavings and much dirt and dust until it has completely stopped revolving.

## FOR USE AS A SANDER:

1. Do not push the sanding disc to the surface to be ground.



**CAUTION: DO NOT PRESS THE DISC GRINDER FORCIBLY AGAINST THE PLANE TO BE GROUND. HEAVY PRESSURE WILL REDUCE THE REVOLVING SPEED AND SUCH DETERIORATE THE FINISHED SURFACE, AND PHENOMENA AS OVERLOAD WILL LEAD TO BURNING LOSS OF THE MOTOR.**

### 2. Sanding angle:

Use only its peripheral surface by tilting the sanding disc at an angle of  $15^{\circ}$  -  $30^{\circ}$ , as shown in Fig. 3-b.

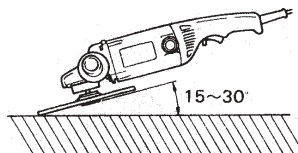

(Fig. 3-b)



**CAUTION: DO NOT UTILIZE THE ENTIRE SURFACE OF SANDING DISC WHEN SANDING.**

# Maintenance and Inspection

## MAINTENANCE AND INSPECTION:



**WARNING: BE SURE TO SWITCH POWER OFF AND DISCONNECT THE PLUG FROM THE RECEPTACLE DURING MAINTENANCE AND INSPECTION.**

1. Replacing the grinding wheel:  
Replace the grinding wheel when it has been worn out to about 2-3/8" (60mm) in external diameter. Confirm that there is no crack or any damage to the grinding wheel. If there is a crack or a transformation in the wheel, replace it immediately.
2. Inspecting the mounting screws:  
Regularly inspect all mounting screws and ensure that they are properly tightened. Should any of the screws be loosened, retighten them immediately.



**WARNING: USING THIS GRINDER WITH LOOSE SCREWS IS EXTREMELY DANGEROUS.**

3. Confirm that there is no damage in the wheel guard, the cord and the housing, etc. Furthermore, confirm that there is no abnormality in the activation of the switch.
4. Inspecting the carbon brushes (Fig. 4):  
The motor employs carbon brushes which are consumable parts. Replace the carbon brush with a new one when it becomes worn to its wear limit. Always keep carbon brushes clean and ensure that they slide freely within the brush holders.

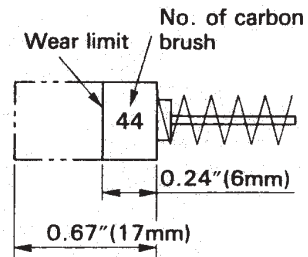

(Fig. 4)



**CAUTION: USING THIS GRINDER WITH A CARBON BRUSH WHICH IS WORN IN EXCESS OF THE WEAR LIMIT WILL DAMAGE THE MOTOR.**

**NOTE:** Use JOHN DEERE carbon brush No. 44 indicated in Fig. 4.

- a. Replacing carbon brushes:  
Remove the brush caps (Fig. 1) with a slotted screwdriver. The carbon brushes can then be easily removed.



# Maintenance and Inspection

## SERVICE AND REPAIRS:

All quality power tools will eventually require servicing or replacement of parts because of wear from normal use. To assure that only authorized replacement parts will be used, all service and repairs must be performed by a JOHN DEERE AUTHORIZED DEALER, ONLY.



**WARNING:** ACCESSORIES FOR THIS POWER TOOL ARE MENTIONED IN THIS INSTRUCTION MANUAL. THE USE OF ANY OTHER ATTACHMENT OR ACCESSORY CAN BE DANGEROUS AND COULD CAUSE INJURY OR MECHANICAL DAMAGE.

## STANDARD ACCESSORIES:

-Wrench	1
-Side Handle	1
-Hexagon Bar Wrench	1

**NOTE:** *Accessories are subject to change without any obligation on the part of JOHN DEERE.*

# Notes

# Notes



#37-0696-090403

©Copyright 2003. John Deere

Manufactured for Deere & Company,  
Moline, Illinois 61265

7-Inch Disc Grinder Operator's Manual  
Download from [www.Somanuals.com](http://www.Somanuals.com). All Manuals Search And Download.  
110 Code No. C99110961 N

## Free Manuals Download Website

<http://myh66.com>

<http://usermanuals.us>

<http://www.somanuals.com>

<http://www.4manuals.cc>

<http://www.manual-lib.com>

<http://www.404manual.com>

<http://www.luxmanual.com>

<http://aubethermostatmanual.com>

Golf course search by state

<http://golfingnear.com>

Email search by domain

<http://emailbydomain.com>

Auto manuals search

<http://auto.somanuals.com>

TV manuals search

<http://tv.somanuals.com>