

## Manual Stair Robot SR1750 HE

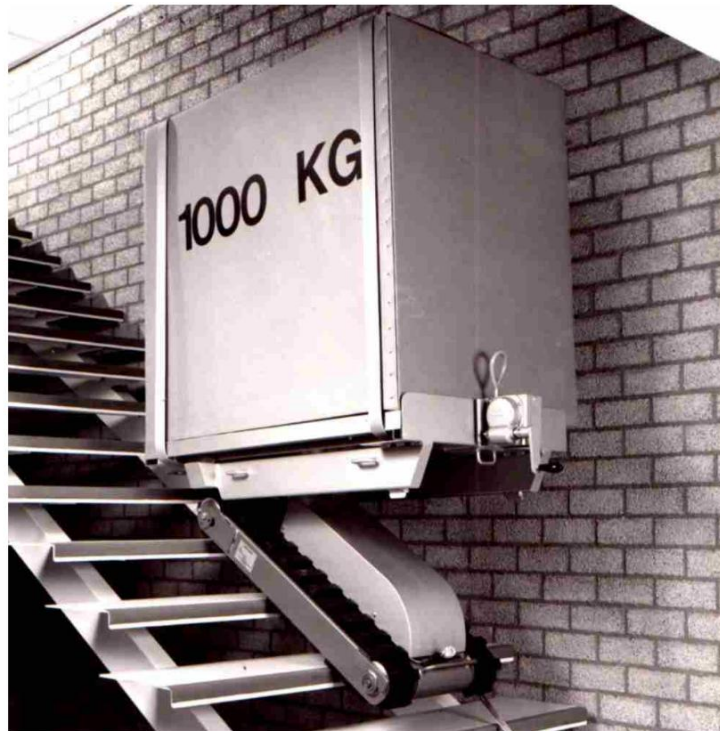

---

## Stairrobot

Type number : SR 1750 HE  
Serial number :  
Year of construction : 2001  
Owner :

Manufacturer :



AATA International b.v.  
Willem 2 straat 1e  
6021 EA Budel  
The Netherlands

Tel : 0031-(0) 495 518214  
Fax : 0031-(0) 495 518515

e-mail: [aata@aata.nl](mailto:aata@aata.nl)  
<http://www.aata.nl>

No part of this publication may be reproduced, stored in a retrieval system or transmitted in any form or by any means, electronic, mechanical, photocopying, recording or otherwise without the written permission of AATA International b.v.

The content of this manual is subject to change without notice. Product specification and design are subject to change without notice.

## Preface

AATA International is an innovative and dynamical company, specialised in stair climbing equipment. Stairrobots are active in over 30 countries worldwide.

This manual is written for machine operators and for technician who take care for the maintenance of the machine. Although the tiniest details are not set out, the manual is a useful help for people who are dealing with the machine on a daily basis.

The stairrobot SR 1750 HE has been used for over 20 years by many well known companies and transport contractors worldwide who are involved in the movement of heavy loads into and out of customers premises.

The stairrobot SR 1750 HE is designed to carry unit loads weighing up to 1000 kg up- and down stairs. The accessory equipment, stair approach ramp, manoeuvring dolly and the turntable, have been designed to assist the movement up to and onto the stairs and the take off from the top and journey to the final destination.

**This manual should be used in conjunction with the cd-rom instruction video, which is placed on the inside of the manuals cover.**

Read this manual and view the instruction cd-rom carefully before putting the SR 1750HE into operation. Always take note of the safety rules as mentioned in chapter "safety".

A copy of this manual should be kept with the machine, so the operator has it at his disposal.

AATA International b.v.

## Table of contents

Preface.....	3
Table of contents .....	4
Survey of standards.....	5
Survey of standards.....	5
<b>1. Technical data.....</b>	<b>6</b>
<b>2. Description main components stair robot SR 1750 HE</b>	
2.1 Drive.....	7
2.2 Transmission and brake.....	7
2.3 Tracks.....	7
2.4 Controls.....	8
2.5 Hydraulic levelling platform.....	8
2.6 Descent adjuster .....	9
2.7 Hydraulic motor and Pump	
<b>3. Ancillary equipment</b>	
3.1 Loading ramp.....	10
3.2 Turntable.....	11
3.3 Winch .....	11
3.4 Dolly .....	11
<b>4. Safety</b>	
4.1 General safety precaution.....	12
<b>5. Operators procedure</b>	
5.1 Pre-use inspection.....	14
5.2 Loading.....	15
5.2.1 The correct position of the load.....	15
5.2.2 Loading procedure .....	16
5.3 Ascending.....	17
5.4 Descending .....	18
5.5 Unloading .....	19
<b>6. Trouble shooting chart.....</b>	<b>20</b>
<b>7. Track replacement .....</b>	<b>22</b>
<b>8. Electrical system chart.....</b>	<b>24</b>
<b>9. Hydraulic system chart .....</b>	<b>25</b>
<b>10. Parts.....</b>	<b>26</b>
10.1 Parts list.....	27
<b>11. CD-rom video.....</b>	<b>28</b>

## Survey of standard

We declare that the construction of the stairrobot SR1750HE is according to the provisions of EC-Directives 89/392/EWG.

Applied harmonized standard:

NEN-EN 60034-5; NEN 10034-6; NEN 10072-2

Applied national standards, directives and technical specifications:

IEC 34-5; IEC 34-7; IEC 72-1

## Survey of symbols

	Not (or not completely) observing the operating instructions can lead to serious accidents or damage
--	--

	Danger as a result of electric tension
---	--

## 1. Technical data SR 1750 HE

Description	Value	Units
Speed	3	Metres p/minute
Lifting capacity	max. 1000	Kg.
Maximum angle	Max. 45	° Degrees
Weight	175	Kg.
Weight including standard accessories	232	Kg.
Colour	~~	~~
Length	1185	Mm
Width	720	Mm
Height	320	Mm
Length loading ramp	1180	Mm
Width loading ramp	720	Mm
Drive-motor: single phase low noise AC		
Thermal cut-out		
Drive-motor capacity	0,75	KW
	1	Hp
Drive-motor power	220 or 110	V
Hydraulic-motor: single phase low noise AC with thermal cut out		
Hydraulic-motor capacity	0,375	KW
	0,5	Hp
Hydraulic-motor power	220 or 110	V
Hydraulic-pump: built directly on the hydraulic Motor		
Hydraulic-pump capacity	0,8	ltr/per minute
Action pressure max.	100	Bar
Capacity oil tank	0,5	Ltr
Control: remote control manually operated		
4-button switch	24	V
Mains	220/110	V
	50	Hz
Extension cord (cupper wire)	3x2,5	Mm2
Extension cord length	25	Mtr

## 2 Description main components stairrobot SR 1750 HE

### 2.1. Drive

- Single phase low-noise AC motor with thermal cut-out

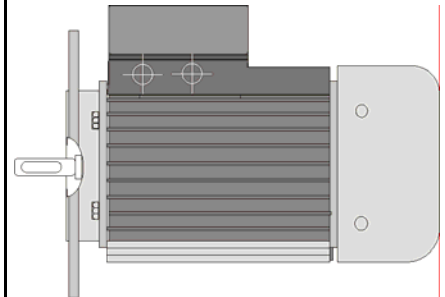

### 2.2. Transmission and brake

- Worm-gearbox built directly onto the driving motor
- The worm-wheel reduction forms an affective brake for the (loaded) StairRobot on the staircase

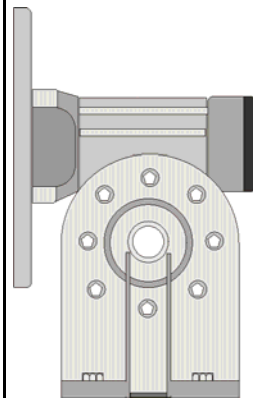

### 2.3. Tracks

- Internally and externally toothed caterpillar tracks, specially designed for smooth stair climbing

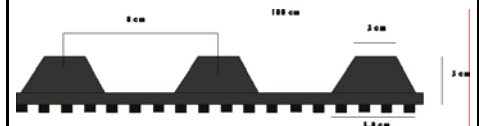

## 2. 4. Controls

- Remote control (2 metres cable attached) manually operated 4-button switch

Press a button to drive



Press and the platform will lower



Press and the platform will lift



Press and the stairrobot will drive forward



Press and the stairrobot will reverse

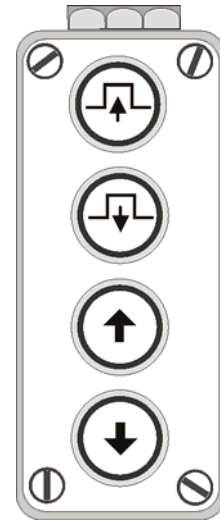

## 2. 5. Hydraulic-levelling platform

- To increase stability the platform can be adjusted to the angle of the staircase by a hydraulic cylinder

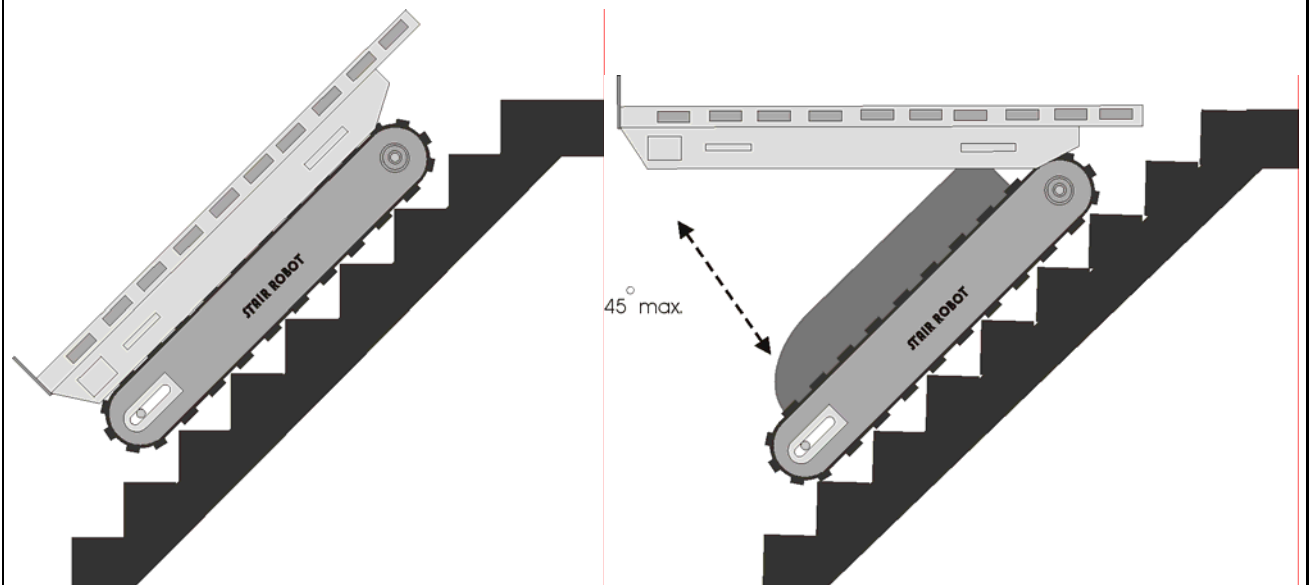



## 2. 6. Descent adjuster

	<ul style="list-style-type: none"> <li>• The descent adjuster is located at the rear end of the machine and is used to adjust the descent of the lifting platform depending on the weight of the load.</li> <li>• Turn maximum clockwise for speed : 0</li> </ul>
---	---

## 2.7. Hydraulic motor and pump

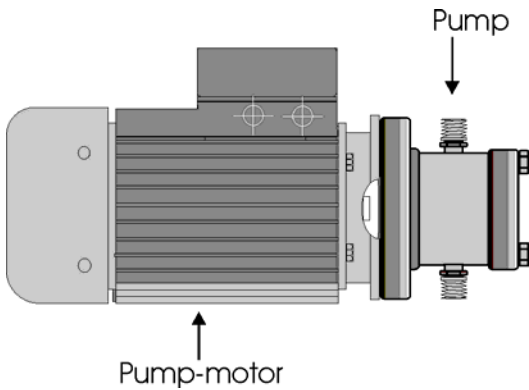
	<ul style="list-style-type: none"> <li>• The hydraulic-motor is placed on the drive motor with the pump built directly onto the motor</li> </ul>
--	--

## 3. Ancillary equipment

### 3.1. Loading ramp

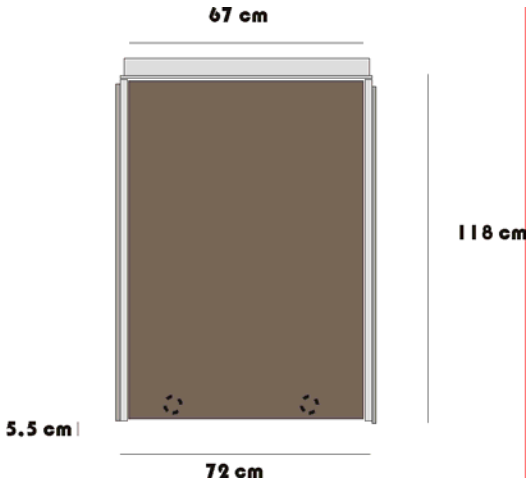
<ul style="list-style-type: none"> <li>• The loading ramp is designed to fit neatly into the stairrobots lifting platform. It provides a safe ridged platform to transport the load from the floor-surface to the load-position on the robot.</li> </ul>	
--	--

### 3.2. Turntable

- The turntable is a circular piece of equipment  $\varnothing$  610 mm, h. 40 mm. constructed out-of two disks of block board with hard-plastic surface to eliminate friction. It is used to alter the direction of travel for the (loaded) StairRobot. There are finger grips on either side for easy lifting or carrying.



### 3.3. Winch

- The winch is designed to fit into the lifting platform of the stairrobot. With the winch a load can be pulled onto the platform with a minimum amount of effort

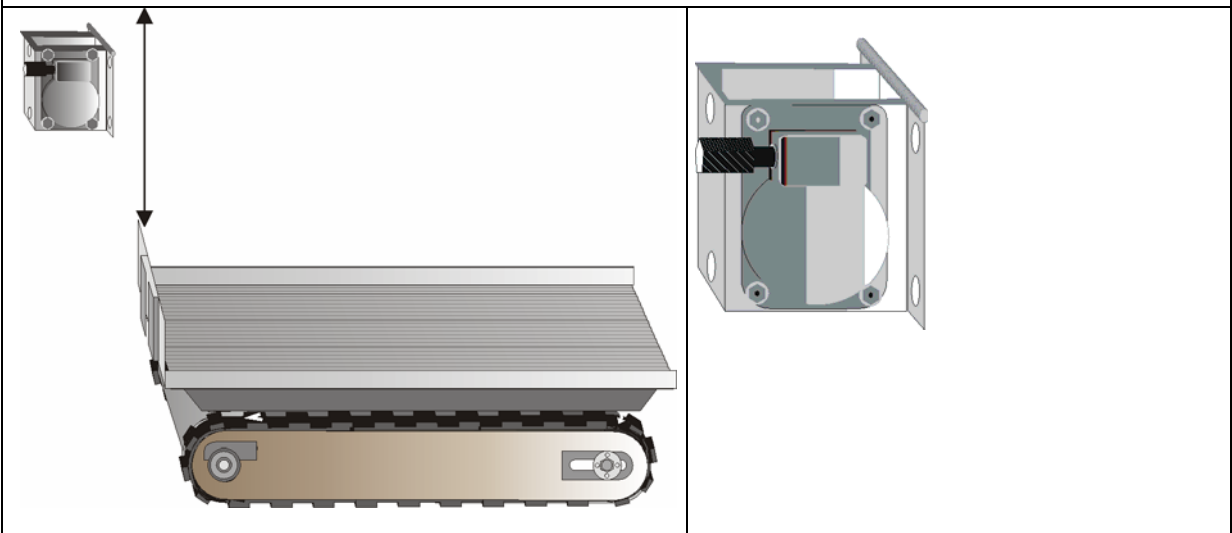

### 3.4. Dolly

- The dolly is constructed of square steel fittings with four heavy-duty swivel wheels for easy movements. An extendable frame can be pulled out to increase stability while driving the StairRobot on the dolly. The lead-off ramp is used to connect the dolly with the stairway

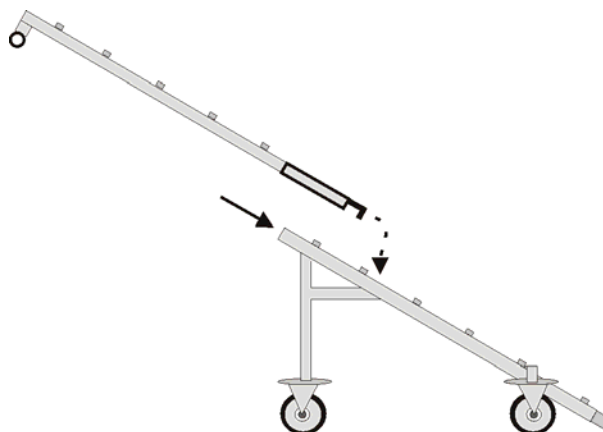
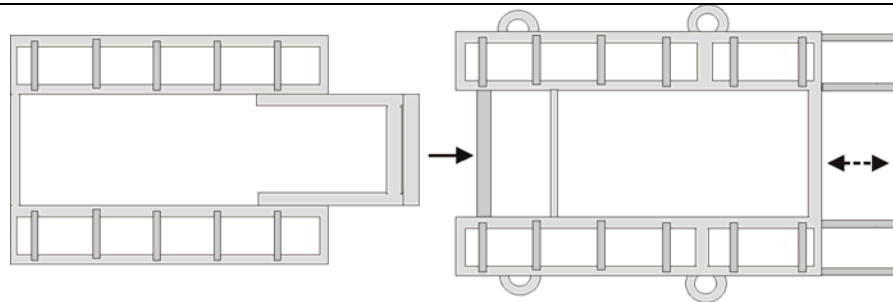



## 4. Safety

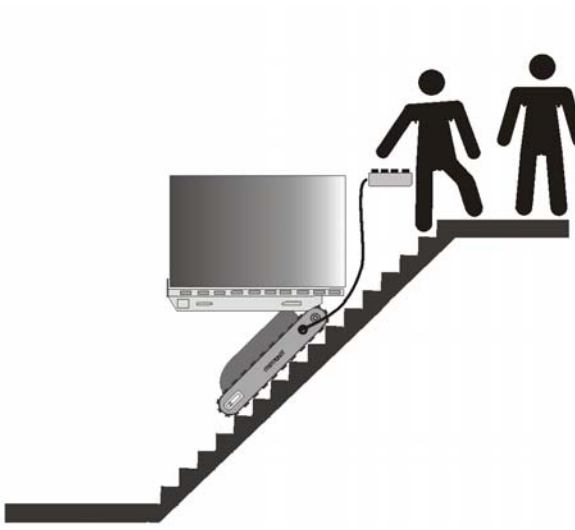

### 4.1. General safety precaution

	<ul style="list-style-type: none"> <li>• It is not permitted to make alterations to the machine.</li> <li>• Everybody who is working with the machine has to be acquainted with the safety rules and has to act upon them.</li> <li>• Two operators are required to operate the stairrobot</li> <li>• Always check the surroundings where the stair-robot will be deployed.</li> <li>• Assure that the angle of the stairs is not more than 45 °</li> </ul>
---	---

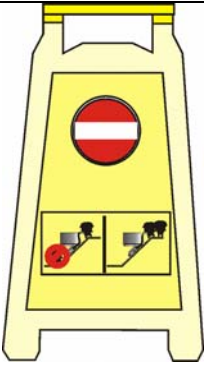
	
--	---

	<ul style="list-style-type: none"> <li>• Make sure that no operator or other person is underneath the (loaded) Stairrobot during operation</li> <li>• Secure the working area using warning boards or blocking ribbon</li> </ul>
---	--

	
---	--

 	<ul style="list-style-type: none"><li>• To avoid misuse by unauthorised persons, don't leave the machine unattended.</li><li>• Within the path of the machine there may be no obstructions.</li><li>• Make sure the environment of the machine is dry, clean and illuminated sufficiently.</li><li>• With the machine in operation it is forbidden to be within the operation area of this apparatus.</li><li>• Before taking the machine into operation the machine operator has to be certain that nobody is located within the operating area of the machine.</li><li>• If the machine is used into the darkness, the operation position has to be illuminated sufficiently (about 50 lux).</li><li>• The machine may only be used for the intended activities.</li><li>• Inspection and maintenance activities have to be done before operation</li><li>• During inspection and maintenance the machine may not be used for other purposes</li><li>• The local action and safety rules have to be acted upon.</li><li>• <b>Make sure you never walk under the robot during operation.</b></li></ul>
	<ul style="list-style-type: none"><li>• Keep electrical switch boxes closed in order to prevent contact danger.</li><li>• Never drive the machine over a cable or extension cord</li><li>• Make sure the mains connection is grounded properly</li><li>• Make sure that no person stands on a cable or extension cord</li><li>• Make sure that the extension cord is unrolled completely</li><li>• Extension cord minimal requirements: 3x 2,5 mm copper wire properly isolated</li><li>• Extension cord must be no longer than 25 meters.</li></ul>

## 5 OPERATORS PROCEDURE

### 5.1. Pre-use inspection

To ensure proper working and safe operation of the SR 1750 HE StairRobot:

- Check that there are no exposed wires in either the main lead or the pendant control
- Check that both the main plug and the continental 16 amp plug and socket are all secure
- Check that the pendant cable is secure in the pendant and at the machine end
- Check that no cable has been deformed. If a deformation is found the use of the machine should be postponed until the cable has been repaired
- If on the dolly; drive the robot of the dolly on a flat surface, listen for excessive or unusual noises from any part of the machine
- Check that the ramp will raise to it's full extend and that it's not leaking oil. When fully extended the ramp should cause the platform's front edges to be in firm contact with the floor and the tracks to be lifted of the floor at the front end about one centimetre
- Irregularities are best noticed by rising the ramp repeatedly to it's full up position and then quickly pressing the down button to release the pressure. If, while the ramp is fully extended the top of the cylinder moves more than 5 mm either towards the front or the back of the Robot then the machine should not be used
- It is quite usual for some oil to be present around the top of the cylinder, however with the up-button pressed and the pump running there should be no oil running down the outside of the cylinder
- Check that the down-button permits the ramp to descend, and in addition check that the descend adjuster permits the speed of the descend to be altered. From fully extended to fully closed should take no less than 25 seconds with an applied load of 80 Kilogram with the ascend adjuster turned maximum counter clockwise
- Check that no rubber blocks on the tracks are severely damaged or torn off
- Check the drive-tooth side of the tracks for exposed stringing cords or damage
- Check that nothing has been trapped between the tracks and the robot
- Check that when going from forward to reverse direction on the pendant button the delay before the tracks start moving in the opposite direction is no longer than one second. Any longer time indicates sloppiness in the drive chain which should be investigated
- Check that the platform sits down on the lower base when lowered
- Check that the castors of the dolly can move in all directions and are not jammed
- Check that the cable of the winch has not been deformed

If there are no defects found the machine is ready for use. If a defect is found do not use the machine until the Stair-Robot is repaired.

## 5.2. Loading

### 5.2.1 The correct position of the load



- If the load is not placed in the correct position on the lifting platform, the Stair robot can get instable during the process of climbing or descending a staircase. This can cause the robot to fall down the stairs resulting in serious damage and injuries.

- The objective is to create an optimal centre of gravity position for the loaded stairrobot considering the 'weight distribution' of the load

	<ul style="list-style-type: none"> <li>• Before positioning the load on the lifting platform the centre of gravity of the load has to be determined</li> </ul>
	<ul style="list-style-type: none"> <li>• Position the load on the platform with the centre of gravity of the load end forward (in positive area)</li> <li>• Position the load with the centre of gravity of the load as low as possible to the lifting platform.</li> </ul>

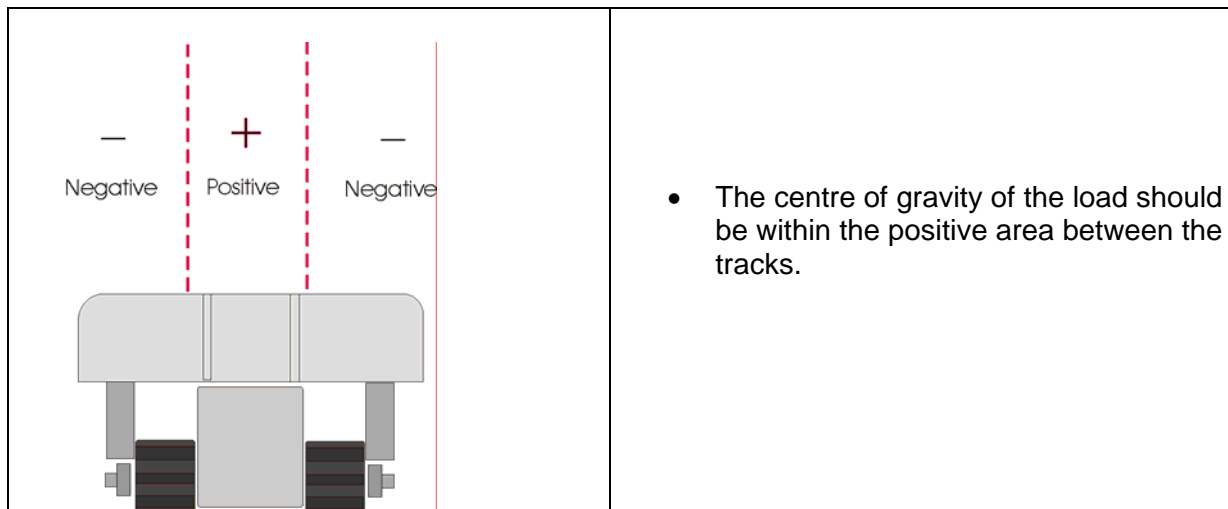

### 5.2.2. Loading procedure

- Start the procedure by securing the area for loading. Move the dolly with the stair robot into the desired position for loading.
- Always unroll extension power cable and connect with the robot before connecting to mains
- Reverse the Robot of the dolly, fit the loading-ramp into position at the front of the robot
- Slot the winch into the lifting platform at the rear of the stairrobot
- Pull the winch-hawser out and connect it with the load. The load can now be winched into position on the stairrobot, one man operating the winch and one man guiding the load of the ramp onto the platform. While operating the winch the lifting platform will rise until the platform has reached the same gradient as the loading-ramp
- Connect the load secure to the lifting platform. Note: never fit any straps to the chassis-bracket
- If the load is secured to the stairrobot the winch and loading ramp can be removed
- Always remove the winch from the stairrobot before ascending the stairway because it adds length to the dimensions of the stairrobot
- Turn the descent-adjuster maximum clockwise
- Lift the platform +/- 10 cm by pushing the up-button
- Push the down-button to lower the platform and turn the descent adjuster counter clockwise until the platform starts to descent. Lower the platform
- The stairrobot can now be driven back on the dolly; use the up-button to keep the 'platform level' in horizontal position



### 5.3. Ascending

Load level

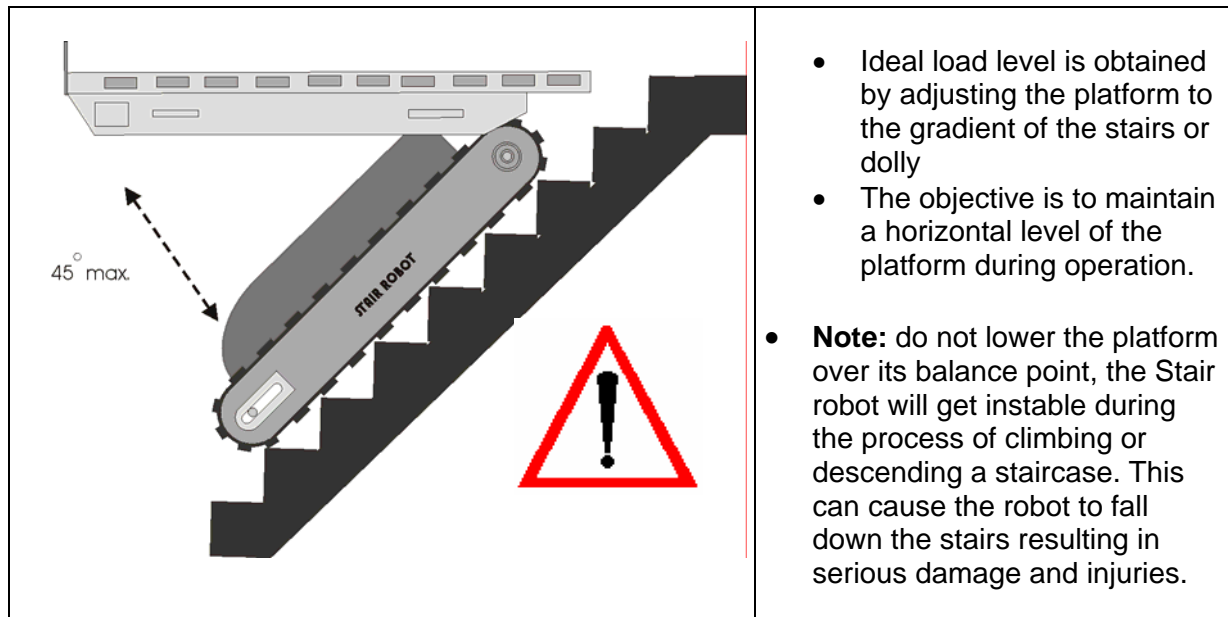

- Move the loaded stairrobot on the dolly with the forward end towards the bottom of the stairs
- Fit the lead on ramp between the dolly and second or third step on the stairs.
- Secure a load support strap (6 m) to the reverse end of the stairrobot. Place the strap across the forward end of the load to be held by one of the operators.
- Both operators should move on to the stairs and make sure that no person is beneath the stairrobot
- One operator will use the remote control button panel and drive the loaded stairrobot up the stairs. The other will firmly hold the load support strap; this will enable him to 'feel' the balance of the load. He also uses it to restrain the load if necessary and helps its forward movement at the top of the stairs
- The control operator will press the forward button to drive the stairrobot over the lead on ramp and up the stairs. He will keep the load level by adjusting the platform position using the up or down button.
- The up or down button can be pressed simultaneously with either forward or reverse



Press and the platform will lower



Press and the platform will lift



Press and the stairrobot will drive forward



Press and the stairrobot will reverse

- The stair robot can be stopped at any stage by just releasing the buttons
- When arriving on top of the stairway; stop the stairrobot on the stairs and place the dolly in position at the top of the stairs in front of the stairrobot. Pull the extendable frame out of the dolly to increase stability
- Start the forward movement again
- Note: expect a change of gradient from the level of the stairs to the gradient of the dolly
- When the stairrobot has reached the 'point of balance', the operator holding the load support strap should assist in the movement by gently pulling the load support strap, to ease the load downward. The other operator should keep the ideal load level during this operation. The stairrobot can then be driven forward to settle onto the dolly
- Transport dolly and load to the unloading point or to the next flight of stairs to continue upwards.

#### 5.4. Descending

- Make sure that the stairway is secured and no person can enter the stairway.
- To descent the stairrobot down the stairway the loaded stairrobot has to be first driven onto the dolly, as previously described for ascending
- Move the loaded stairrobot on the dolly with the downward end towards the edge of the top of the step and stop 10 cm away.
- One operator will drive the stairrobot using the control panel while the other operator will steady the load firmly using a load support strap.
- Press the reverse button to drive the robot from the dolly and down the stairs
- The up and down button is used to maintain ideal load level
- By reversing slowly, 5 cm at a time, and stopping at the 'point of balance' the control operator will be able by pressing the up button gently alter the centre of gravity so as to lower the reverse end tracks onto the top of the stairs.
- The dolly should be moved aside when the stairrobot is fully on the stairs.
- Drive the robot in reverse down the stairs steadying the movement throughout by using the a load support strap
- Depending on the gradient, the stair robot will ride on the edge of two or three steps at once. The rubber tracks pressing firmly onto the stairs
- On some stairs it may be found that occasionally two of the rubber treads ride on the stair edge and when the third tread releases it's grip the stairrobot will move down suddenly about 2,5 cm until all three treads grip once more. This occurrence should be expected by the operators and the stair robot should be driven on without a pause
- Before arriving at the bottom of the stairs the dolly and the lead on ramp should be placed in position with the lead on ramp resting on the second or third step.
- Drive the stairrobot of the stairs and onto the dolly keeping the ideal load level by using the up or down button
- Transport dolly and load to the unloading point or to the next flight of stairs to continue downwards.

## 5.5. Unloading

- Start the procedure by securing the area for unloading. Move the dolly with the stair robot into the desired position for unloading.
- Reverse the Robot of the dolly, fit the loading-ramp into position at the front of the robot
- Slot the winch into the lifting platform at the rear of the stairrobot
- Pull the winch-hawser out and connect it with the load. Disconnect the load from the lifting platform
- The load can now be lowered to floor level, one man operating the winch and one man guiding the load of the ramp onto the floor. While lowering the load the lifting platform will rise until the platform has reached the same gradient as the loading-ramp
- If the load is on the floor the winch and loading ramp can be removed



- All these techniques should be practised with a light load first

## 6 Trouble shooting chart

The stairrobot SR 1750 HE is designed and built to function for several years with little maintenance. In case a problem occurs please make the following checks. If the problem continues to exist please contact your local dealer

Symptom	Possible course	Solution
<ul style="list-style-type: none"> <li>Main motor does not work</li> </ul>	<ul style="list-style-type: none"> <li>No current</li> </ul>	<ul style="list-style-type: none"> <li>Check electrical wires and connections</li> <li>Check magneto switches</li> <li>Check capacitors</li> </ul>
<ul style="list-style-type: none"> <li>Hydraulic pump-motor does not work</li> </ul>	<ul style="list-style-type: none"> <li>No current</li> </ul>	<ul style="list-style-type: none"> <li>Check electrical wires and connections</li> <li>Check magneto switches</li> <li>Check capacitors</li> </ul>
<ul style="list-style-type: none"> <li>Main motor stops</li> </ul>	<ul style="list-style-type: none"> <li>Motor overheated</li> </ul>	<ul style="list-style-type: none"> <li>Wait several minutes</li> </ul>
<ul style="list-style-type: none"> <li>Hydraulic pump-motor stops</li> </ul>	<ul style="list-style-type: none"> <li>Motor overheated</li> </ul>	<ul style="list-style-type: none"> <li>Wait several minutes</li> </ul>
<ul style="list-style-type: none"> <li>Hydraulic platform does not lift completely</li> </ul>	<ul style="list-style-type: none"> <li>Possible oil-shortage</li> </ul>	<ul style="list-style-type: none"> <li>Refill oil with spindle oil; check oil in oil-tank; should be 5 mm under the top of the tank</li> </ul>
<ul style="list-style-type: none"> <li>Hydraulic platform does not go down</li> </ul>	<ul style="list-style-type: none"> <li>Pressure relieve valve</li> <li>Electro-magneto switch does not work properly</li> </ul>	<ul style="list-style-type: none"> <li>Open valve by turning it counter clockwise, move the platform up and down a few times; adjust the valve to the weight of the load</li> <li>Check electrical wiring and connections</li> </ul>

Symptom	Possible course	Solution
<ul style="list-style-type: none"><li>Oil leaks from hydraulic ram</li></ul>	<ul style="list-style-type: none"><li>Ram packing worn</li><li>Plunger bent</li></ul>	<ul style="list-style-type: none"><li>Replace o-ring and back-up ring with repair set</li></ul>
<ul style="list-style-type: none"><li>Hydraulic platform does not move up</li></ul>	<ul style="list-style-type: none"><li>Under pressure in hydraulic system</li></ul>	<ul style="list-style-type: none"><li>Remove the wood plate of the lifting platform and unscrew the valve on the oil-tank pipe; move the platform in up position by hand and turn valve screw tight</li></ul>

## 7 Track replacement

- Loosen both bolts a1 and a2
- Turn bolts b1 and b2 counter clockwise until the axle is at point d
- Remove track at point C
- To install the new track, reverse the above procedure

*Drawing (1.)*

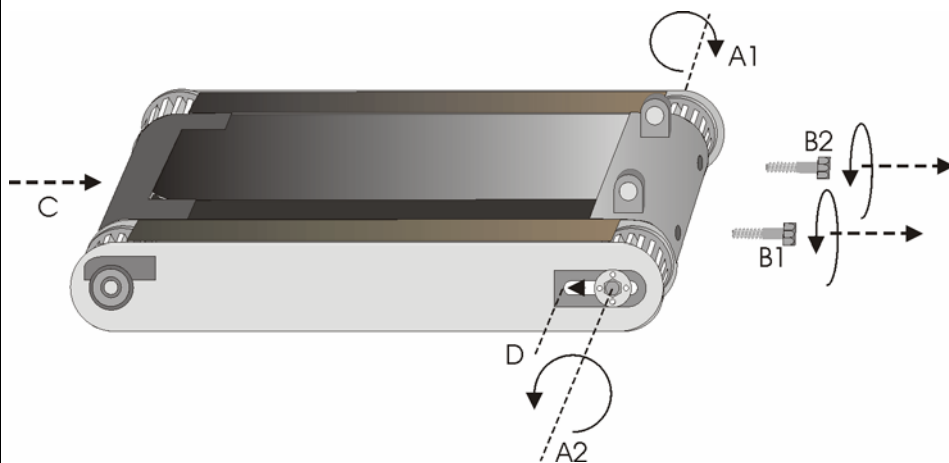

*Drawing (2.)*

-  After replacing tracks make sure that the > marks on both tracks are in the same direction and position

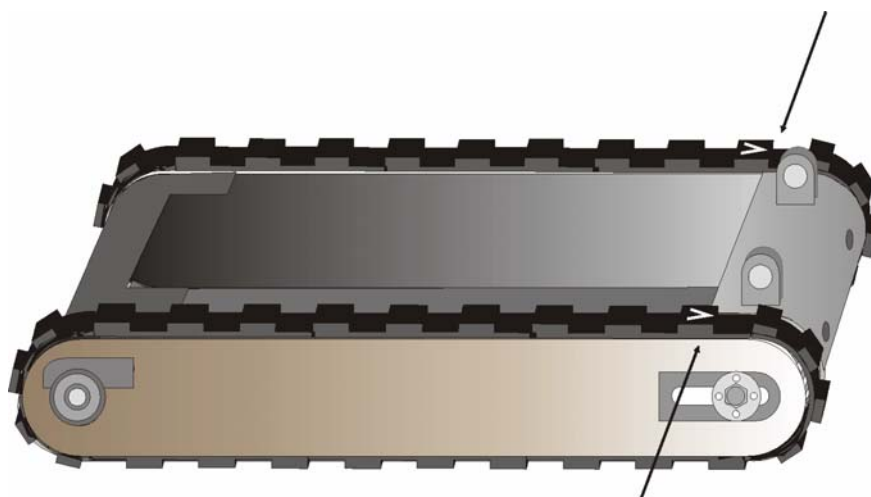

- Proper track tolerance at point F is +/- 10 mm (pulled by hand) drawing (3.)
-  Make sure that the distances A1 ....A4 are equal on both sides of the Stairrobot (drawing 4)

Drawing (3.)

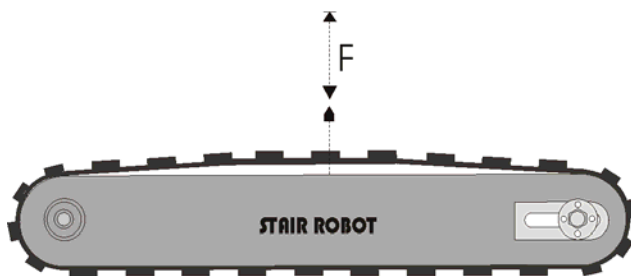

Drawing (4.)

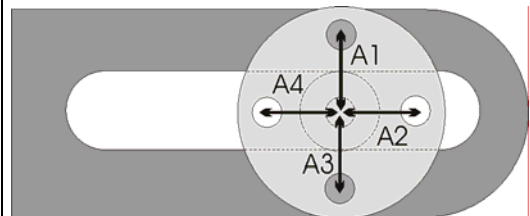

## 8 Electrical system

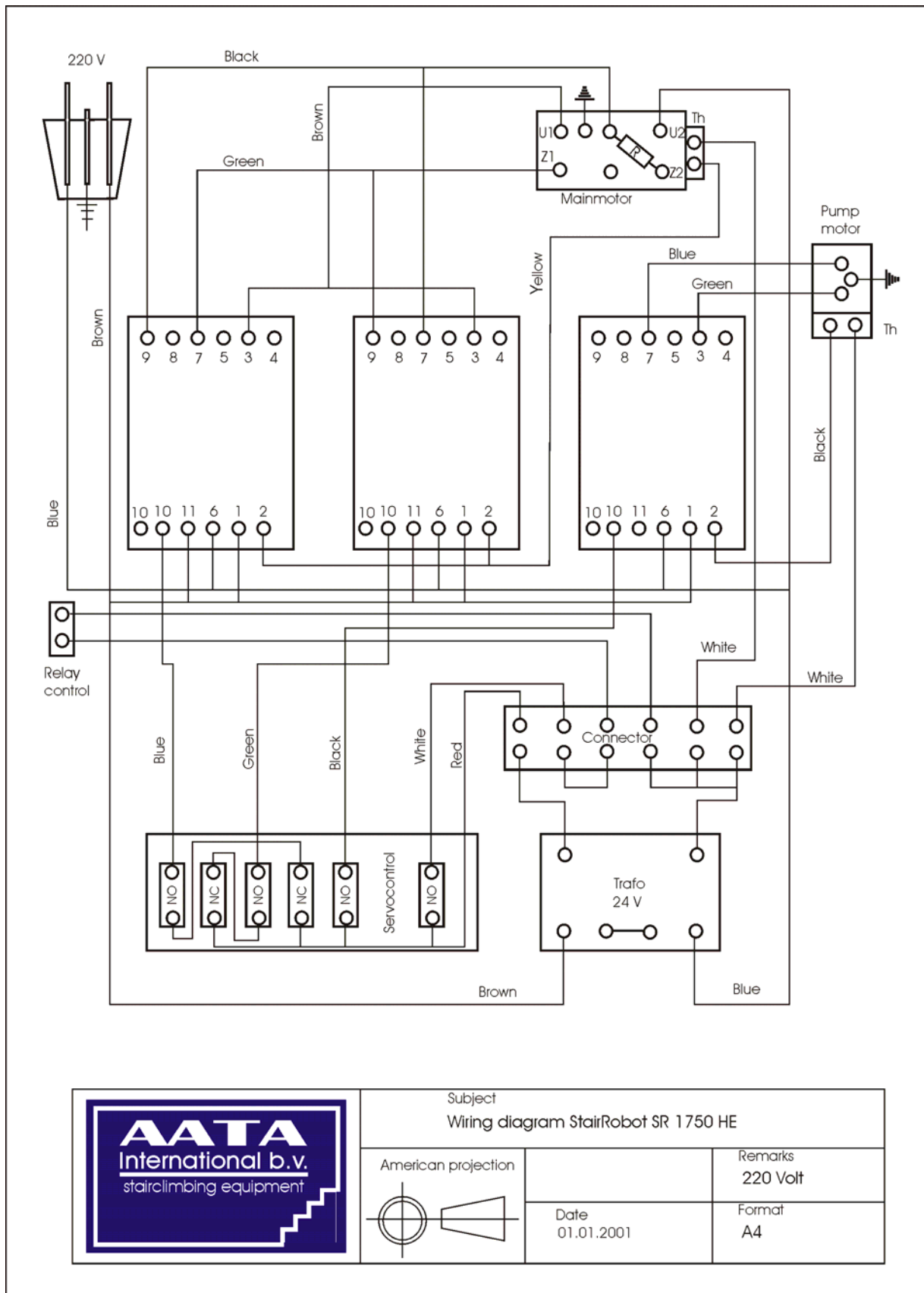



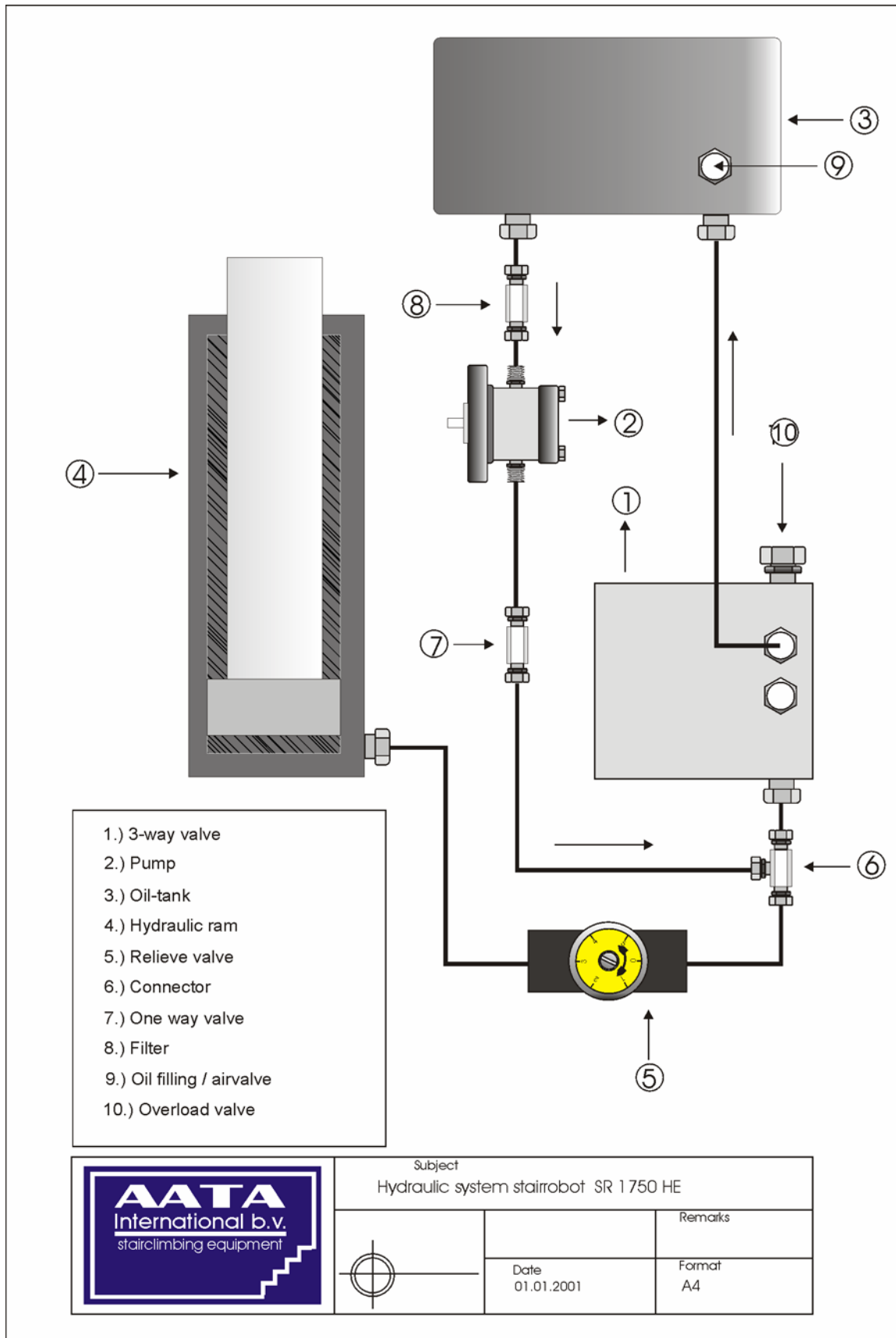

9 Hydraulic system

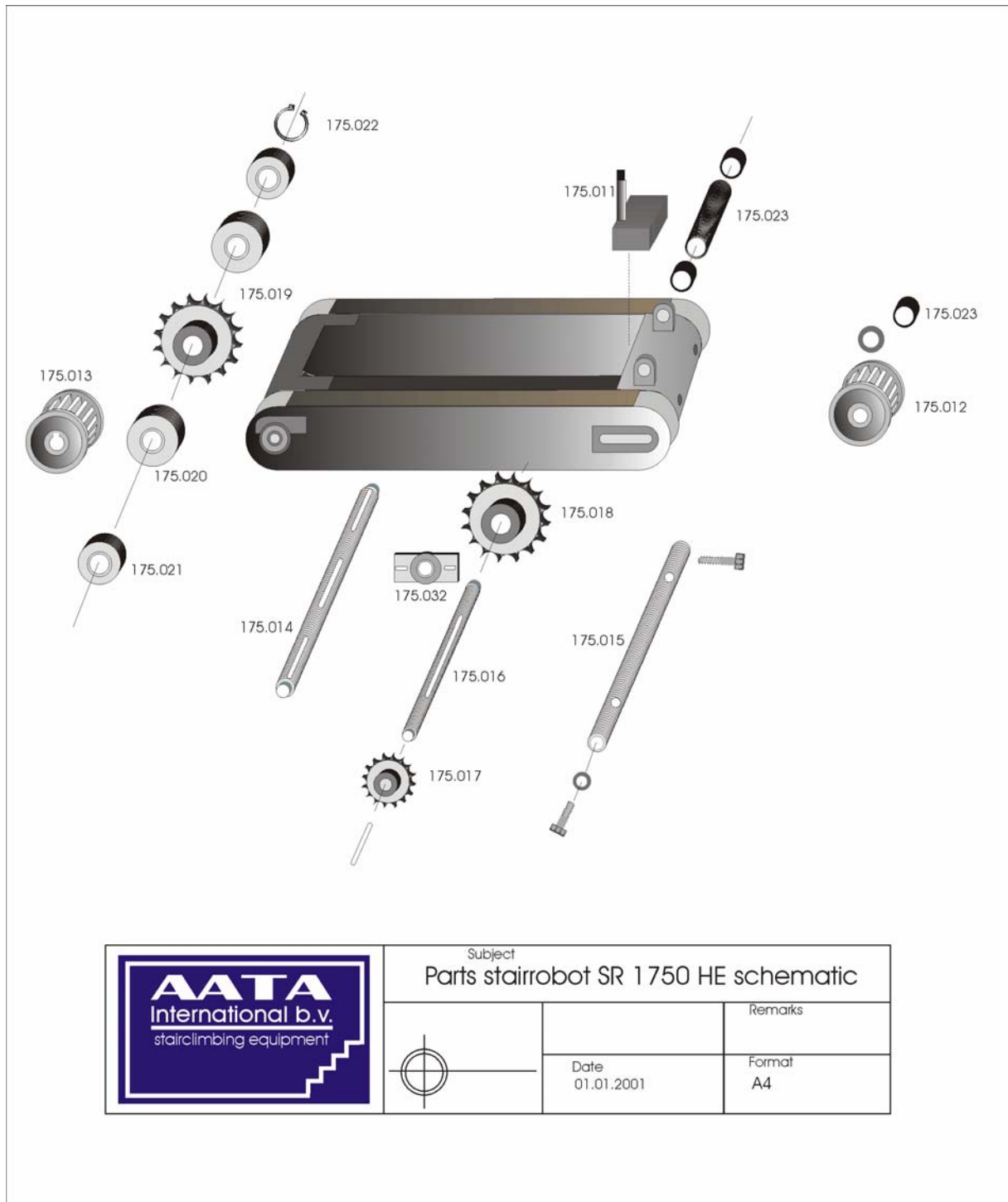

10. Parts



	Subject		
	Parts stairrobot SR 1750 HE schematic		
		Remarks	
	Date	Format	
01.01.2001	A4		

## 10.1. Parts list

Art.nr.:	Article
175.001A	Main motor
175.001B	Gearbox
175.002	Hydro-motor
175.003	Hydro-pump
175.003B	Oil-seal hydro pump
175.007	4-button switch unit
175.008	Magneto switch
175.009	Transformer 220V/24V
175.011	Oil tank
175.012	Caterpillar wheel Rear
175.013	Caterpillar wheel Front
175.014	Front axle
175.015	Rear axle
175.016	Drive axle
175.017	Gearwheel 11 T
175.018	Gearwheel 38 T
175.019	Gearwheel 20 T
175.020	Bearing axle 30
175.021	Bearing axle 20
175.022	Lock ring
175.023	Teflon 303635
175.024	Teflon304030
175.032	Bearing holder
175.033	Teflon ring 51312
175.040	Top cross beam
175.041	Bottom cross beam
175.042	Hydro-ram
175.043	Filter
175.044	Relief valve
175.045	Main selector valve
175.046	Electro-unit
175.050	Capacitor 8uf
175.051	Capacitor 100 uf
175.077	Hydro-pipe set
175.100	Caterpillar track
175.101	Dolly
175.102	Ramp-board
175.103	Turn disk
175.104	Winch
175.105	Winch-handle

## 11. CD-Rom video

Content:

- Stair robot general promotion video (mpeg1)
- Instruction video SR 1750 HE (mpeg1)
- Instruction video SR 450 (mpeg1)

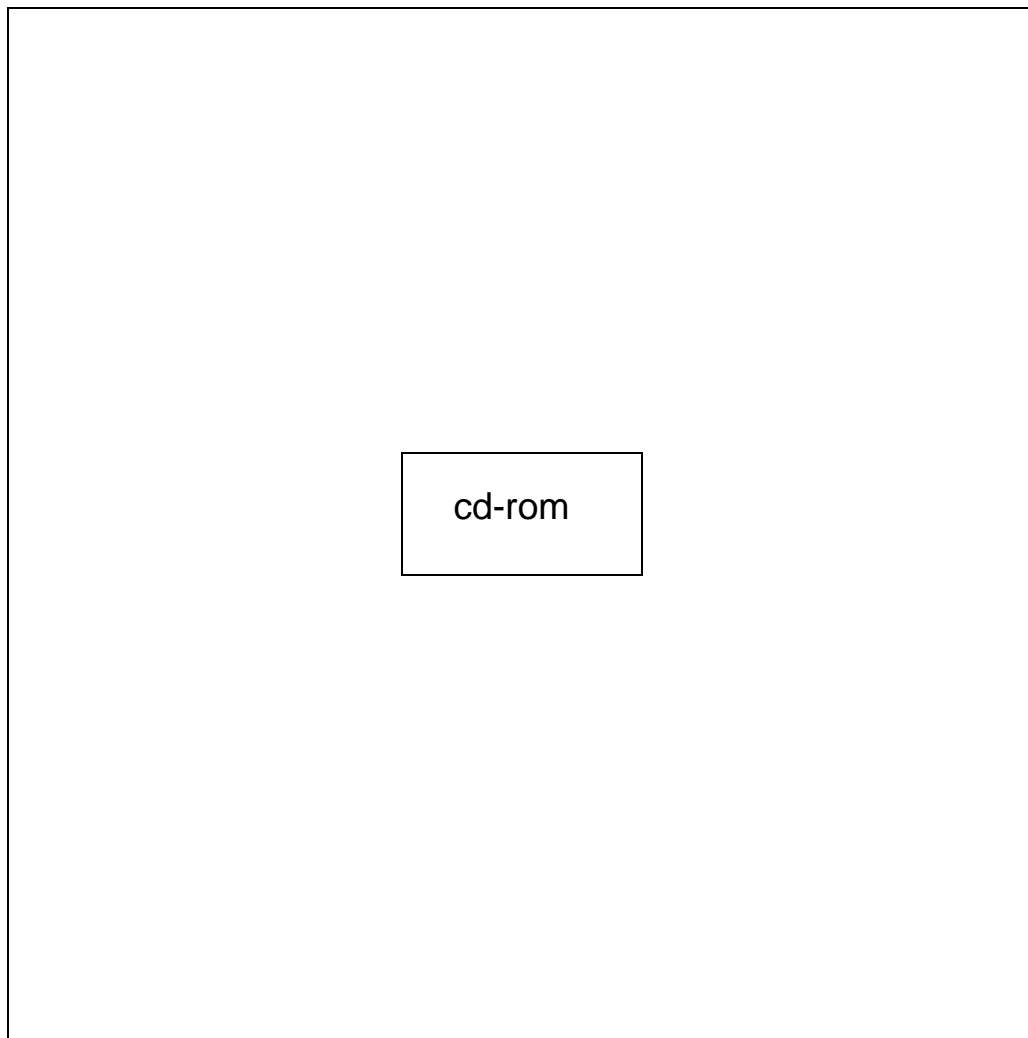

## Free Manuals Download Website

<http://myh66.com>

<http://usermanuals.us>

<http://www.somanuals.com>

<http://www.4manuals.cc>

<http://www.manual-lib.com>

<http://www.404manual.com>

<http://www.luxmanual.com>

<http://aubethermostatmanual.com>

Golf course search by state

<http://golfingnear.com>

Email search by domain

<http://emailbydomain.com>

Auto manuals search

<http://auto.somanuals.com>

TV manuals search

<http://tv.somanuals.com>