

JLDV 02 vented tumble dryer

Instruction manual

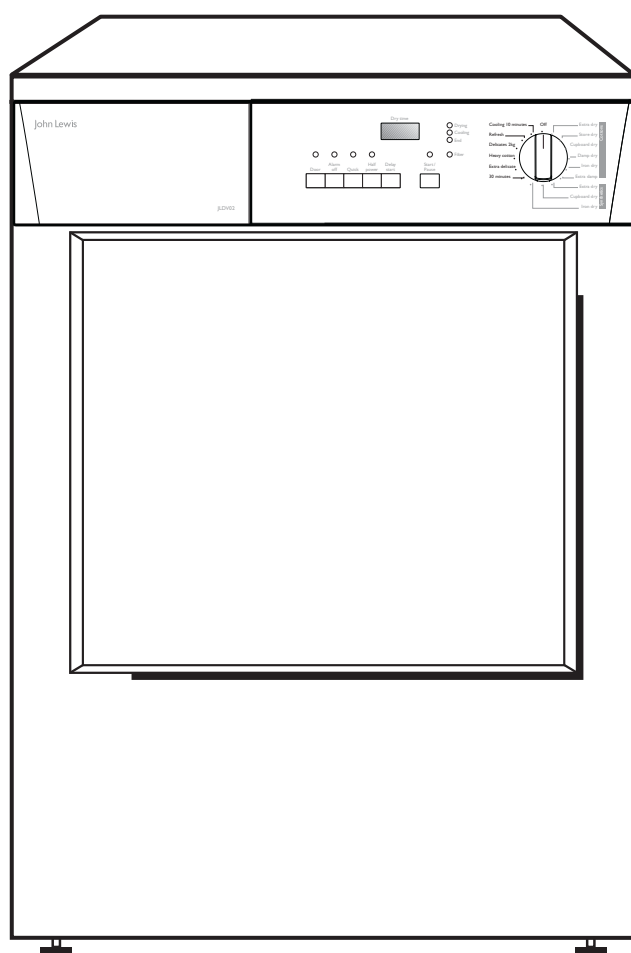

John Lewis



Important Safety Information

It is most important that this instruction book should be retained with the appliance for future reference. Should the appliance be sold or transferred to another owner, or should you move house and leave the appliance, always ensure that the book is supplied with the appliance in order that the new owner can get to know the functioning of the appliance and the relevant warnings.

These warnings have been provided in the interest of safety. You **MUST** read them carefully before installing or using the appliance.

If you are unsure of the meanings of these warnings contact the John Lewis branch from which you purchased the appliance.

Installation

- This appliance is heavy. Care should be taken when moving it.
- It is dangerous to alter the specifications or attempt to modify this product in any way.
- Any electrical work required to install this appliance should be carried out by a qualified electrician or competent person.
- Care must be taken to ensure that the appliance does not stand on the electrical supply cable.
- If the machine is situated on a carpeted floor, please adjust the feet in order to allow air to circulate freely.
- If the tumble dryer is placed on top of a washing machine, it is compulsory to use the stacking kit (optional accessory).
- As some bulky items such as duvets and eiderdowns should be dried in large commercial machines because of their bulk, check with the manufacturer of the item if it is suitable for drying in a domestic machine, even if the dry weight of the item is within the limit advised.
- Please make sure that no gas lighters have accidentally been left in pockets of garments to be loaded into appliance.
- **Danger of explosion:** Never tumble dry items that have been in contact with inflammable solvents (petrol, methylated spirits, dry cleaning fluid and the like). As these substances are volatile, they could cause an explosion. Only tumble dry items washed with water.
- In order to avoid danger of fires caused by excessive drying, do not use appliance to dry the following items: Cushions, quilts and the like (these items accumulate heat).
Items containing rubber foam or materials similar to rubber foam.

Child Safety

- This appliance is designed to be operated by adults. Children should not be allowed to tamper with the controls or play with the product.
- Pets and children have been known to climb into tumble dryers. Please check your drum before use.
- Keep all packaging well away from children.
- When the appliance is to be scrapped, cut off the electrical supply cable and destroy the plug with the remaining cable. Disable the door catch in order to prevent children from becoming trapped inside while playing.
- Leave the door slightly ajar when the appliance is not being used. This will allow the seal to be preserved.
- Clean fluff filters after using tumble dryer. To prevent fire risks, do not use the appliance if the fluff filters are damaged.
- Do not allow fluff to accumulate around the dryer.
- Under no circumstances should you attempt to repair the machine yourself. Repairs carried out by inexperienced persons may cause injury or serious malfunctioning. Contact the telephone number given under Repairs - After Sales Service (Page 19).
Always insist on genuine John Lewis spare parts.

Use

- Do not overload the appliance (see programme chart).
- Clothes which are dripping wet should not be placed in the dryer.
- **Risk of fire:** items that have been spotted or soaked with vegetable or cooking oil constitute a fire hazard and should not be placed in the tumble dryer.
- If you have washed your laundry with stain remover you must execute an extra rinse cycle before loading your tumble dryer.

Maintenance and Cleaning

- For information on maintenance and cleaning your tumble dryer see page 16 of this Instruction manual.

Service

- This product should only be repaired or serviced by an authorised Service Engineer and only genuine approved spare parts should be used.



Ecological hints

To save energy we recommend that you follow these hints:

- Try to load the maximum capacity of the machine as small loads are **uneconomical**.
- Always load well spun laundry. The higher the spin speed, the lower the electricity consumption and the shorter the drying times.
- Do not over-dry laundry, this avoids creasing and saves energy.
- Clean the filters regularly to avoid excessive drying times and high electricity consumption.
- The room should be well ventilated for the tumble Dryer to operate efficiently. The room temperature should not exceed +35°C during drying.



Environmental Information

- After unpacking please dispose of the packaging with due regard to safety and the environment
- Materials marked with the symbol  are recyclable.
- Check with your local Council or Environmental Health Office to see if there are facilities in your area for recycling this appliance.
- When the appliance is to be scrapped, cut off the power supply cable and make the door closing device unusable to prevent young children from being trapped inside.
- Check with your local Council or Environmental Health Office to see if there are facilities in your area for recycling this appliance.

Warning !



A cut off plug inserted into a 13amp socket is a serious safety (shock) hazard. Ensure that the cut off plug is disposed of safely.



The symbol  on the product or on its packaging indicates that this product may not be treated as household waste. Instead it shall be handed over to the applicable collection point for the recycling of electrical and electronic equipment. By ensuring this product is disposed of correctly, you will help prevent potential negative consequences for the environment and human health, which could otherwise be caused by inappropriate waste handling of this product. For more detailed information about recycling of this product, please contact your local city office, your household waste disposal service or the shop where you purchased the product.

Contents

For the User

Important Safety Information **2**

- Installation

Description of the Appliance **5**

The Control Panel **10**

- Door Release Button 10
- No Buzzer Button 10
- Quick Dry Button 10
- Low Temperature Button 10
- Delay Start Button 10
- Display 11
- Start/Pause Button 11
- Indicator Lights 12
- Programme/Time Selector Dial 13

Programme Chart **13**

Using your tumble dryer **14**

Hints & Tips on Drying **15**

Maintenance and Cleaning **16**

- External cleaning 16
- Cleaning the door 16
- Cleaning the filters 16
- Cleaning the drum 16

Adjusting the level of conductivity **17**

Something Not Working **18**

Repairs - After Sales Service **19**

Spare parts **19**

For the Installer

Installation **6**

Technical Specifications **6**

6

- Unpacking 7

- Positioning 7

- Fitting the vent hose 7-8

- Stacking kit (optional accessory) 8

- Door reversal 8

Electrical connection **9**

Guide to using the Instruction Manual

The following symbols will be found in the text to guide you throughout the instructions:

 **Safety instructions**

 **Hints and tips**

 **Environmental information**

 This appliance complies with the following E.E.C. Directives:

- 73/23 EEC of 19.2.73 (Low Voltage Directive) and subsequent modifications;

- 89/336 EEC of 3.5.89 (Electromagnetic Compatibility Directive) and subsequent modifications.

Description of the Appliance

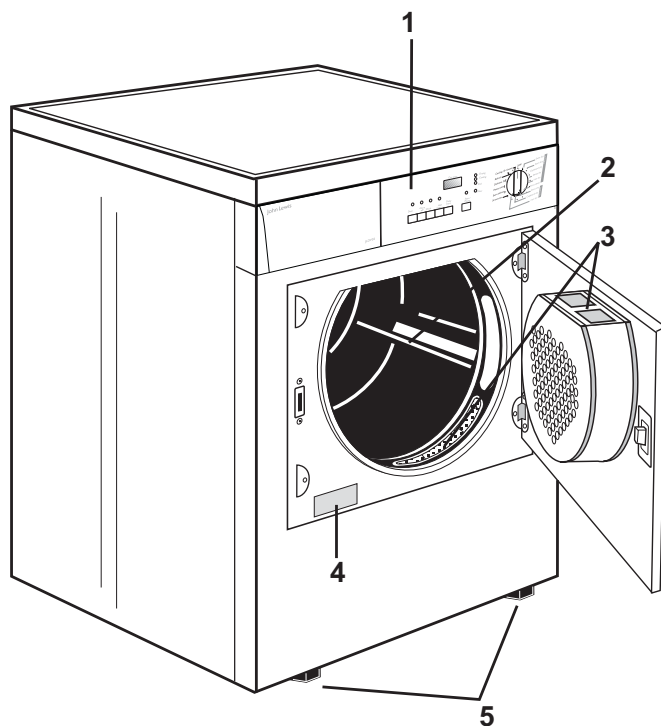

- 1 Control panel
- 2 Drum Light
- 3 Fluff filters
- 4 Rating Plate
- 5 Adjustable feet

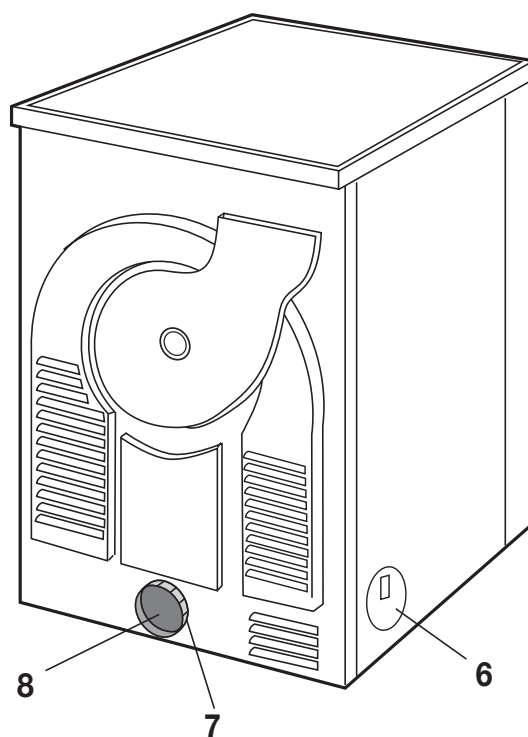

- 6 Side vent outlet
- 7 Ring nut
- 8 Rear vent outlet



Installation

-  It is dangerous to alter the specifications or attempt to modify this product in any way.
-  Care must be taken to ensure that the appliance does not stand on the electrical supply cable.
-  Any electrical work required to install this appliance should be carried out by a qualified electrician or competent person.

Technical Specifications

DIMENSIONS	Height Width Depth	85 cm (33.5") 60 cm (23.6") 58 cm (22.8")
POWER SUPPLY VOLTAGE TOTAL POWER ADSORBED		230-240 V/50 Hz 2650 W (13A)
MAX LOAD CAPACITY	Cotton, linen Synthetics	6 kg (13.2 lbs) 3 kg (6.6 lbs)
DRUM VOLUME		108 l
CONSUMPTIONS	Cotton, linen Cotton, linen Synthetics	3.30 kWh (6 kg cupboard dry) 2.60 kWh (6 kg iron dry) 1.10 kWh (3 kg cupboard dry)

Unpacking

Warning !

 Slide out the polythene bag containing the polystyrene block before using the appliance. Pull off adhesive strips from inside machine on top of drum.

Keep all packaging away from children

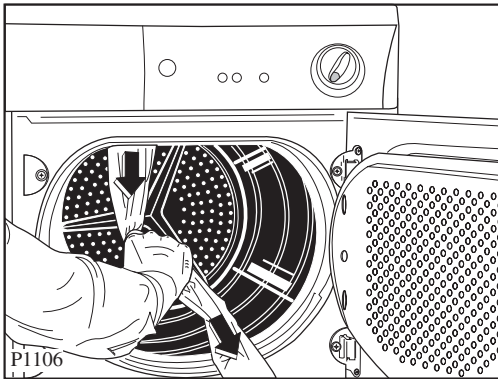

 **Should the appliance be moved, it must be transported vertically.**

Positioning

It is recommended that, for your convenience, the machine is positioned close to your washing machine. The tumble dryer must be installed in a clean place, where dirt does not build up.

Air must be able to circulate freely all around the appliance. It is important to ensure the air intake grills on the back of the dryer are not obstructed with any materials (e.g. paper, rags etc.). Obstructing the grills could be dangerous or at least seriously impair the efficiency of the tumble dryer.

To keep vibration and noise to a minimum when the dryer is in use, it should be placed on a firm, level surface. Once in its permanent operating position, check that the dryer is absolutely level with the aid of a spirit level. If it is not, raise or lower the feet until it is.

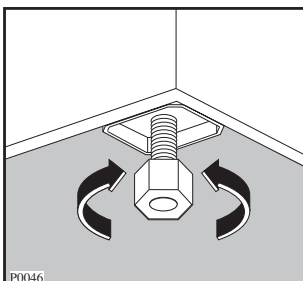

The feet must never be removed.

Do not restrict the floor clearance through deep-pile carpets, strips of wood or similar. This might cause heat build-up which would interfere with the operation of the appliance.

Important

The hot air emitted by the tumble dryer can reach temperatures of up to 60°C. The appliance must be sited in a well ventilated room but not be installed on floors which are not resistant to high temperatures.

When operating the tumble dryer, the room temperature must not be lower than +5°C and no higher than +35°C, as it may affect the performance of the appliance.

Fitting the vent hose

Depending on the position of the tumble dryer to an outside wall there is a choice of 3 vent outlets: One at the back, the others on the left or right hand side.

Connect the hose to whichever is the more convenient by pulling the ring nut (A) from the vent outlet at the back, screwing it on to the hose and pushing it firmly back into place.

The unused vents should now be sealed with the special snap covers provided.

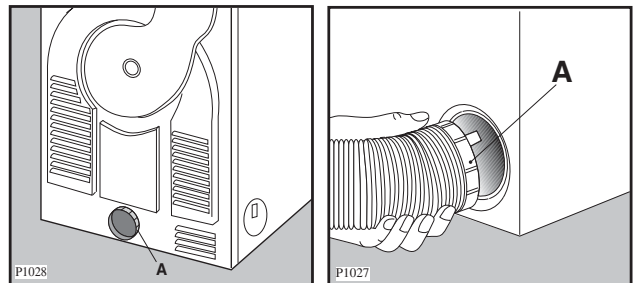

Advice: If the hose is long and the room temperature low, the moisture might condense to water inside the hose. **This is nothing to be concerned about.**

To prevent this water from lying in the hose or flowing back into the tumble dryer, it is advisable to drill a small hole (dia. 3 mm) in the lowest point of the hose and to place a small container below it. (See picture, point B).

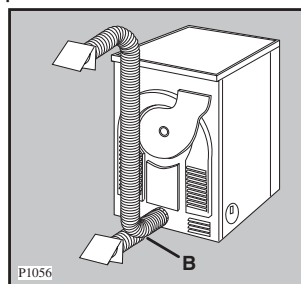

Once connected to the dryer, run the vent hose to the desired outlet point, ensuring that the run's overall length is less than 2 m, and that it contains no more than two bends. As to the outlet itself, if you have decided on a fixed wall/window grille, a good local builder's merchant should be able to supply you with the necessary fittings and installation advice.

It is important not to connect the vent hose to items designed to carry exhaust from a fuel burning appliance, eg. cooked hoods, chimney or flue pipes.

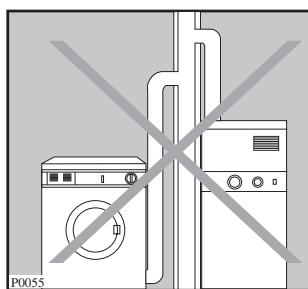

Hints and Tips

Note that to avoid condensation problems, it is essential that the dryer be fitted with the flexible hose to carry its "exhaust" at least beyond the kitchen units; preferably outside the kitchen.

In order to prevent the appliance from overheating, it is important that the steam exhaust is unobstructed. Therefore, in case of a permanent hose fitted to an exterior wall or ceiling, it must be ensured an exhaust capacity of at least 150 m³/h.

If the dryer is fitted next to kitchen units, make sure that the vent hose is not squashed. If the hose is partially squashed, drying efficiency will be reduced, resulting in longer drying times and higher energy consumption.

If the hose is completely squashed, the safety cut-outs with which the machine is fitted may operate.

Stacking kit (optional accessory)

It should be possible to stack your new dryer on top of a front loading washing machine with a cover's depth between 48 and 60 cm.

Read carefully the instructions supplied with the stacking kit.

Please contact your local John Lewis branch for further advice.

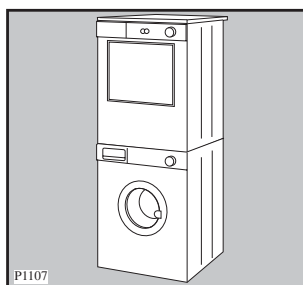

Door reversal

To make it easier to load or unload the laundry the door can be reversed.

This operation must be carried out by qualified personnel.

Please contact the telephone number given under Repairs - After Sales Service, page 19.

Electrical connection

Any electrical work required to install this appliance should be carried out by a qualified electrician or competent person.



WARNING: THIS APPLIANCE MUST BE EARTHED.

Should the appliance power supply cable need to be replaced, this must be carried out by a Service Force agent (see page 19).

The manufacturer declines any liability should this safety measure not be observed.

Before switching on, make sure the electricity supply voltage is the same as that indicated on the appliance's rating plate. (See picture on page 5).

The appliance is supplied with a 13amp plug fitted. In the event of having to change the fuse in the plug supplied, a 13amp ASTA approved BS 1363/A fuse must be used.

Should the plug need to be replaced for any reason, proceed as described below. The wires in the mains lead are coloured in accordance with the following code:

Green and Yellow	- Earth
Blue	- Neutral
Brown	- Live

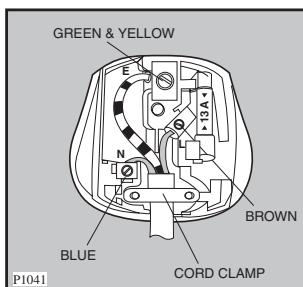

If you fit your own plug, the colours of the wires in the mains lead of your appliance may not correspond with the markings identifying the terminals in your plug.

Proceed as follows:

1. Connect the Green and Yellow (earth) wire to the terminal in the plug which is marked with the letter "E" or the earth symbol \perp or coloured green and yellow.
2. Connect the Blue (neutral) wire to the terminal in the plug which is marked with the letter "N" or coloured black.
3. Connect the Brown (live) wire to the terminal in the plug which is marked with the letter "L" or coloured red.

4. Upon completion there must be no cut, or stray strands of wire present and the cord clamp must be secure over the outer sheath.

WARNING:

A cut off plug inserted into a 13 amp socket is a serious safety (shock) hazard.

Ensure that the cut off plug is disposed of safely.



The plug must still be accessible after the appliance has been installed.



The appliance should not be connected to the electrical supply by means of an extension cable

Permanent connection

In the case of permanent connection it is necessary that you install a double pole switch between the appliance and the electricity supply (mains), with a minimum gap of 3mm between the switch contacts and of a type suitable for the required load in compliance with the current electrical regulations.

The switch must not break the yellow and green earth cable at any point.

The control panel

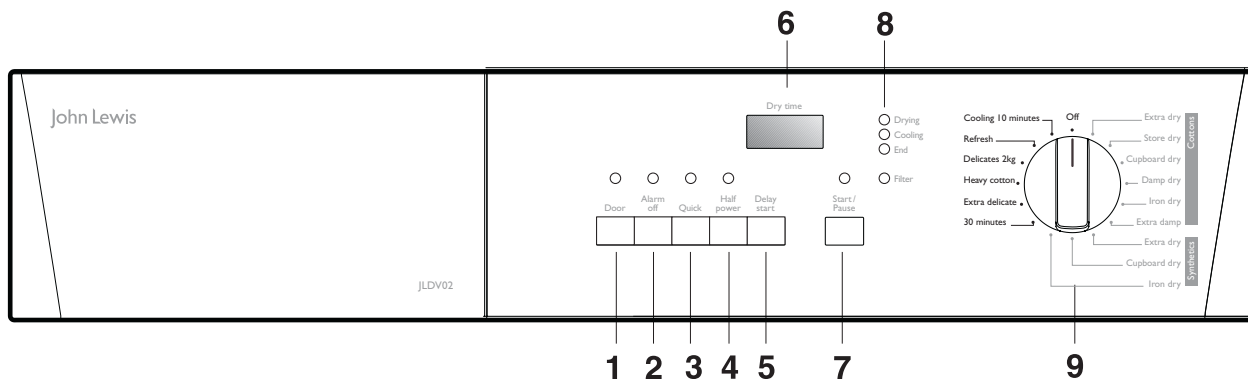

1 Door release Button

Press this button to open the door. The light above the button will illuminate.

Opening the door by means of this button is possible only if the tumble dryer is on (programme selector dial set to a programme or drying time).

If you open the door during a programme, in order to restart the programme you must press the START/PAUSE button again after having closed the door.

2 Alarm off Button

A buzzer sounds

- when selecting the programme
- when depressing the buttons
- when an incorrect option selection is made
- when the programme selector dial is turned to another position during the programme or when you depress an option button during the cycle
- at the end of the programme
- if the machine is not working correctly
- when the small door at the bottom is open.

By depressing the button the acoustic signal is switched off.

The corresponding light comes on.

3 Quick dry Button

By depressing this button the drying time is reduced in the following COTTON programmes:

- EXTRA DRY
- CUPBOARD DRY
- STORE DRY

The corresponding pilot light comes on.

This option **cannot** be selected with HALF POWER function.

4 Half Power Button

Pressing this button allows drying to be performed at a lower temperature, for delicate items.

The corresponding pilot light comes on.

This option can also be used for time controlled drying. This option **cannot** be selected with QUICK and DELICATES programme.

5 Delay Start button

This button allows you to delay the starting of the programme by up to 12 hours.

This option must be selected **after** having selected the programme and **before** pressing START/PAUSE to start the programme.

Every time the button is pressed, the time is increased by 30 minutes, until the display shows a delay of "2 hours". After this, the delay is displayed hour by hour.

The minutes or hours of delay that have been selected are displayed for 2 seconds, then the display shows the duration of the previously selected programme.

The countdown begins after you have pressed the START/PAUSE button.

To cancel the delay time, during the drying phase the START/PAUSE button to set your appliance to pause and then press the DELAY START button until the display indicates 0'. Then press the START/PAUSE button again.

When the delay is cancelled, the display shows the duration of the programme.

During the delayed start, it is not possible to change the programme or the delay time that has been selected. To do this, you must first switch off the machine by setting the programme selector dial to "Off". Select the new programme, the options and the delayed start, then press the START/PAUSE button.

If you wish to add more laundry while the machine is performing the countdown, simply open the door. When you close the door, press the START/PAUSE button again to cause the countdown to be resumed.

6 Display

The display shows the following information:

- duration of selected programme
- delayed start
- end of programme
- incorrect option selection
- alarm code

- **Duration of selected programme**

After you have selected the programme, its duration (in hours and minutes) appears on the display. It is calculated automatically on the basis of the maximum load accepted for each type of fabric and of the required degree of drying.



When the programme starts, the remaining time is displayed every 5 minutes.

- **Delayed start**

If you have selected a delay time by means of the relevant button, the display shows it for 2 seconds; then it shows the duration of the previously selected programme. The countdown is displayed every 30 minutes until it displays "90 minutes" and then hour by hour.



- **End of programme**

A **flashing zero** indicates the end of the programme and it is displayed after the "anti-creasing" phase.

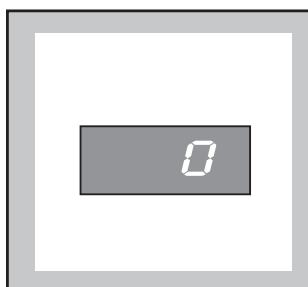

- **Incorrect option selection**

If you select an option that is not compatible with the programme you have selected, the display shows **Err** (error).

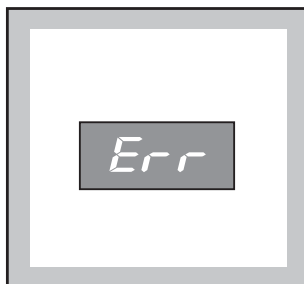

This code will reappear during the execution of the programme if you press one of the option buttons.

- **Alarm code**

In the case of a functional problem, the display shows an alarm code (e.g. E21). See page 13 for more detailed information.



7 Start/Pause button

Press this button to start the dryer after having selected the programme and the options.

The relevant light will stop flashing. If you have chosen a delayed start, the machine will begin the countdown.

If the door of the appliance or the small door at the bottom is opened while the programme is running, this button must be pressed again after closing the door in order to restart the programme from the point at which it was interrupted.

In both cases the light of the Start/Pause button flashes to remind you that the start button needs to be pressed again.

8 Indicator Lights

These lights indicate the following functions:

“Drying” light

This light indicates that the appliance is in the drying phase.

“Cooling” light

This light indicates that the appliance is in the cooling phase. At the end of drying, there is a 10 minute cooling phase to cool the laundry.

“End” light

This light illuminates at the end of the cooling phase, during the anti-creasing phase and at the end of the programme.

“Filter” light

This light illuminates at the end of the programme to remind you that the filters must be cleaned.

9 Programme/Time Selector Dial

Allows you to select electronically controlled or time controlled drying.

Turn the dial to the required programme or time.

Electronically controlled drying (automatic)

The appliance runs these programmes with the help of sensors which detect the degree of dampness of the laundry.

Simply select the programme according to the type of laundry and degree of drying required.

Time controlled drying

This can be used to finish off drying if necessary.

Select the 30 minute programme for synthetics.

To cancel a programme which is running, turn the programme selector dial to “**Off**”.

At the end of drying, turn the selector dial to “**Off**” to switch the machine off before removing the laundry.

If the programme selector dial is turned to another position, when the machine is running, the buzzer will sound and the programme phase indicator lights will flash.

Programme Chart

Automatic drying (electronic programmes)

Type of laundry	Degree of drying required	Max-load ⁽¹⁾
Cotton	Extra dry	6 kg
	Store dry	6 kg
	Cupboard dry	6 kg
	Damp dry	6 kg
	Iron dry	6 kg
	Extra damp	6 kg
Synthetics	Extra dry	3 kg
	Cupboard dry	3 kg
	Iron dry	3 kg
Synthetics or mixed fabrics which do not require ironing	Extra delicate	2.5 kg
Jeans	Heavy cotton	6 kg
Jumpers	Delicates	2 kg
Synthetics	Refresh	2.5 kg

- Extra delicate cycle is a special programme for synthetics or mixed fabrics which do not require ironing, and need to be "STORE DRY".
- Delicates is a special programme for jumpers to be dried "store dry".
- Refresh cycle is a special programme for synthetics.

Time controlled drying

Type of laundry	Drying time	Max-load ⁽¹⁾	Programme selector dial position
Synthetics	30 min	3 kg	30' minutes

(1) Never overfill the drum (do not load large quilts, for example).

Drying times vary according to:

- The type of laundry
- The size of the load
- The degree of water extraction obtained during the spin cycle of the washing machine.
- The degree of dryness required

Cooling 10 minutes

This position on the programme selector dial can be used to freshen the laundry (e.g. to remove a persistent odour of moth-balls).

Load

It is often difficult to estimate the weight of items to be dried. We therefore recommend that you adopt the following guidelines:

- **cotton, linen:** drum full but not too tightly packed;
- **synthetics:** drum no more than half full;
- **delicate fabrics:** drum no more than one third full.

Using the tumble dryer

Before using your tumble dryer for the first time, we recommend that you to place a few damp cloths inside the appliance and dry for 30 minutes. There may be dust inside a brand new tumble dryer.

Drying

1. Connect the appliance.
2. Open the door (see picture).

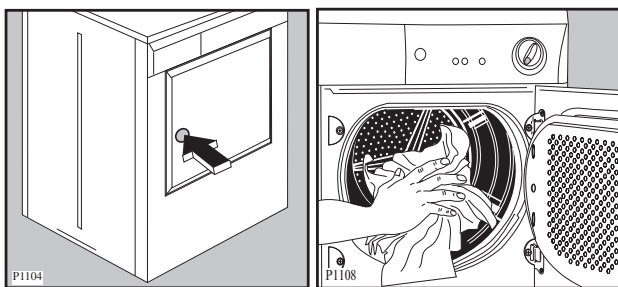

3. Load the items one at a time, shaking them out loosely.
4. Close the door. Please check the laundry does not get caught between the door and filter.
5. Select the drying programme or time. The lights DRYING, COOLING and END come on. The light of the START/PAUSE button flashes and the display shows the duration of the programme.
6. If required, press the HALF POWER button and/or the ALARM OFF button or the QUICK button.
7. Select the DELAY START if required. The selected delay appears on the display for 2 seconds, then the duration of the selected programme is displayed.
8. Press the START/PAUSE button: the corresponding light stops flashing and drying starts. Only the DRYING light stays lit. If you have selected the DELAY START, the machine begins its countdown.

If the programme selector dial is turned to another position, when the machine is running, the buzzer will sound, the programme phase indicator lights will flash.

The drum turns alternately in both directions during drying.

All drying programmes end with a 10 minute cooling phase (COOLING light illuminates).

You may remove the laundry after this phase.

The lights END and FILTER illuminate and the buzzer sounds.

The display shows a static zero.

9. If the laundry is not removed at the end of the cycle, the dryer performs an **anti-creasing** phase (duration: 30 minutes maximum).

If you do not remove the laundry, the dryer will stop automatically at the end of the anti-creasing phase.

The END and FILTER lights remain lit and the buzzer sounds every 10 seconds for 2 minutes.

The light of the START/PAUSE button goes off and a flashing zero appears on the display.

10. Turn the programme selector dial to “Off”; all the lights go out. The appliance is switched off.

Remove the laundry.

If you open and then close the door before turning the programme selector dial to “Off”, all the lights corresponding to the phases making up the performed programme come on and the display shows the duration of the programme.

After each use

- Clean the filters (see page 16).

Important!

If the drying programme has to be stopped before it reaches the end, we recommend that you turn the programme selector dial to position “Cooling” and wait until the end of this phase before removing the laundry. This will avoid a build-up of heat inside the appliance. To do this first turn the dial to “Off” and then to “Cooling” and depress START/PAUSE Button.

Modifying the programme

To change a programme which is running, first cancel it by turning the programme selector dial to “Off”. Select the new programme and press the START/PAUSE Button.

Hints & Tips on Drying

Before placing articles of laundry in your tumble dryer, check the care labels to ensure they are recommended for tumble drying.

Care Labels you may find on your laundry

 may be tumble dried

 normal drying (high temperature)

 delicate drying (low temperature)

 do not tumble dry

 **Do not overload the appliance.**

Here is a list of the approximate weight of some common laundry items.

Sheet	700 to 1000 g
Pillowcase	100 to 200 g
Tablecloth	400 to 500 g
Table Napkin	50 to 100 g
Kitchen Towel	70 to 120 g
Linen Hand Towel	100 to 150 g
Hand Towel	150 to 250 g
Bath Towel	700 to 1000 g
Bathrobe	1000 to 1500 g
Shirt	200 to 300 g
Apron	150 to 200 g

- Always load well spun laundry. The higher the spin speed the lower the electricity consumption and the shorter the drying time.
- **DO NOT** load dripping wet laundry into the dryer. Roll the article in a towel or spin to remove excess water.
- Close poppers and zips and fasten any buttons.
- Sort the laundry. Separate synthetics from cotton/linens, and dry separately.
- Remove the laundry immediately after the programme has finished.
- Use a fabric conditioning sheet to reduce static. We recommend the sheet is pinned to an article of laundry (using a safety pin).
- Mix the load i.e. large and small articles.
- When drying large items such as sheets, we recommend you periodically stop the dryer to redistribute the load.

DO NOT use the tumble dryer to dry the following:

- Articles contaminated with inflammable substances e.g. petrol, cleaning solvents, cooking oil, fats or hair lacquer.
- Woollen and synthetic/wool mixtures unless the item is labelled as suitable for tumble drying.
- Very delicate articles such as silk.
- Very large and bulky items such as duvets or sleeping bags.

Maintenance and Cleaning

You must **disconnect** the appliance from the electricity supply, before you can carry out any cleaning or maintenance work.

External cleaning

Use only soap and water and then dry thoroughly.

Important: do not use methylated spirit, diluents or similar products.

Cleaning the door

Clean periodically the interior part of the door to remove any fluff from the seals around the filter.

Regular cleaning ensures correct drying.

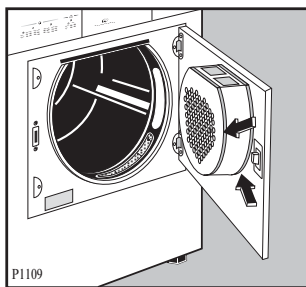

Cleaning the filters

Your dryer will only function well if the filters are clean. The filters collect all the fluff which accumulates during drying and they must therefore be cleaned at the end of each programme, before removing the laundry, with a damp cloth. The FILTER light reminds you to carry out this operation.

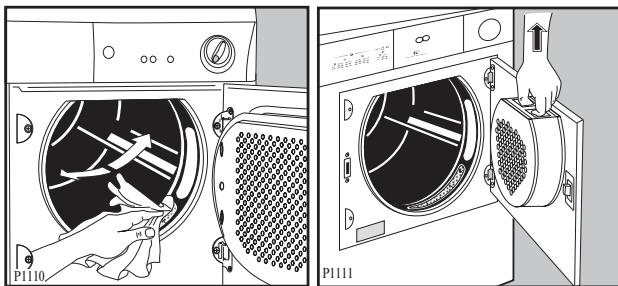

The filter in the inner door must be removed for cleaning. Do not be alarmed by the amount of fluff. It is not due to excessive wear caused by the dryer. All fabric loses fluff when line-drying but it goes un-noticed in the air. In a tumble dryer it simply collects in the filter.

After a while, a whitish coating due to detergent residue on laundry forms on the filters. When this occurs, clean the filters with warm water using a brush. Remove the filter in the door opening as per picture (it can be positioned with the tooth facing to the left or to the right).

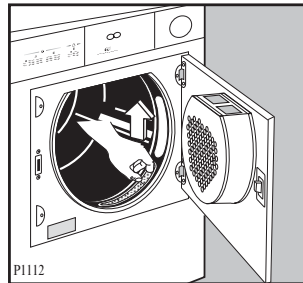

 **Do not use the appliance without filters.**

Cleaning the drum

If the laundry is not drying to the level of dryness you have set, either too dry or too damp, we advise you to clean the inside of the drum with a cloth soaked with vinegar.

This will eliminate the slight residue of detergent and softeners used in the washing, or to any residue lime contained in the water. A build up of these residues will prevent the sensors from correctly measuring the degree of dryness of the laundry.

Adjusting the level of conductivity

Water contains, a variable quantity of limestone and mineral salts of which quantities vary according to geographical locations thus varying its conductivity values.

Relevant variations of the conductivity of the water compared to those prefixed by the factory could slightly influence the residual humidity of the laundry at the end of the cycle.

Your dryer allows you to regulate the sensitivity of the drying sensor based on conductivity values of the water by using the following procedure.

To establish the hardness of your water to correspond with the table opposite please contact your local water authority.

Display	Conductivity degree	Approximative value (µS/cm)
CO _	Low	< 300
CO =	Medium	300 - 600
CO ≡	High	> 600

Memorising the new setting:

Simultaneously press down the buttons **3** and **6** until the previous drying cycle time appears again on the display and the buzzer sounds.

Procedure:

Turn the programme selector dial to switch on the appliance

In selection mode press simultaneously the buttons **3** and **6** until «CO» appears on the digits.

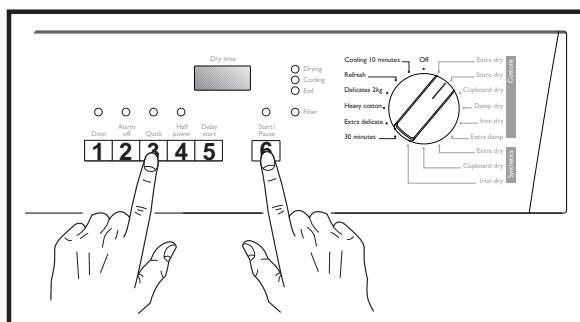

Adjusting the level of conductivity:

Press the button 5 sequentially: the level of conductivity is indicated by the lighting of the horizontal hyphens.

Something Not Working

If the tumble dryer is not working correctly, please carry out the following checks before contacting your local Service Force agent.

IMPORTANT: If the END light flashes, the buzzer sounds and an alarm code is displayed, switch the machine off and call the telephone number given below.

IMPORTANT: If you call out an engineer to a fault listed below, or to repair a fault caused by incorrect use or installation a charge will be made even if the appliance is under guarantee.

Symptom	Solution
The tumble dryer does not start	<ul style="list-style-type: none">• The door(s) has (have) not been closed.• The plug is not properly inserted in the power socket.• There is no current at the socket.• The main fuse or the fuse in the plug has blown.• The selector dial is not set correctly.• The START/PAUSE Button has not been depressed.• The DELAY START option has been selected.
Drying takes too long or laundry is not dry enough.	<ul style="list-style-type: none">• The laundry has not been spun properly.• The filters and are clogged.• The room temperature is too high.• The selected time or drying cycle was not suitable for the laundry.• The LOW TEMPERATURE button has been pressed.• There is too much laundry inside the appliance.• The dryer is not correctly installed.
The drum light does not light up:	<ul style="list-style-type: none">• The Programme/Time selector dial is on position "OFF".• The lamp is defective.

Repairs - After Sales Service

In the unlikely event of your appliance requiring service, or if you wish to purchase spare parts, please contact our extended warranty administrators by telephoning:

0870 010 7887

They will give you details for your local Service Force Centre.

Before calling out an engineer, please ensure you have read the details under the heading "Something Not Working".

When you contact your local Service Force Centre you will need to give the following details:

1. Your name, address and post code
2. Your telephone number
3. Clear and concise details of fault
4. The purchase date and found on your receipt.
5. The model and serial number of the appliance (found on the rating plate - see picture on page 5)

So that you always have these numbers at hand, we recommend you to make a note of them here:

Mod. :

PNC :

S.N. :

Your dryer is covered by a 3 year parts and labour guarantee (see separate details given at point of sale). Please retain your purchase receipt safely for the service engineer to verify the purchase details.

Spare parts

Always insist on genuine spare parts.

An authorised service engineer should service this product, and only genuine spare parts should be used. Under no circumstances should you attempt to repair the machine yourself. Repairs carried out by inexperienced persons may cause injury or serious malfunctioning. Contact your local Service Force Centre. An authorised service engineer always insist on genuine spare parts.

John Lewis Partnership
171 Victoria Street
London SW1E 5NN

www.johnlewis.com

Free Manuals Download Website

<http://myh66.com>

<http://usermanuals.us>

<http://www.somanuals.com>

<http://www.4manuals.cc>

<http://www.manual-lib.com>

<http://www.404manual.com>

<http://www.luxmanual.com>

<http://aubethermostatmanual.com>

Golf course search by state

<http://golfingnear.com>

Email search by domain

<http://emailbydomain.com>

Auto manuals search

<http://auto.somanuals.com>

TV manuals search

<http://tv.somanuals.com>