

JLTDH15

Tumble dryer

Instruction manual

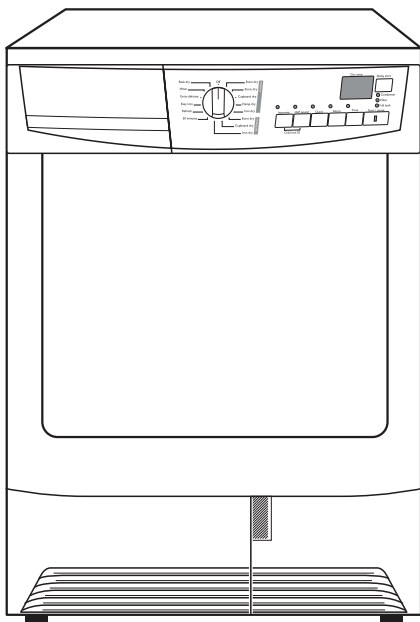

John Lewis



Important safety information

It is most important that this instruction book should be retained with the appliance for future reference. Should the appliance be sold or transferred to another owner, or should you move house and leave the appliance, always ensure that the book is supplied with the appliance in order that the new owner can get to know the functioning of the appliance and the relevant warnings.

These warnings have been provided in the interest of safety. You **MUST** read them carefully before installing or using the appliance. If you are unsure of the meanings of these warnings contact the John Lewis branch from which you purchased the appliance.



- Please read the instruction book before using this appliance.

General safety

- It is dangerous to alter the specifications or attempt to modify this product in any way.
- This appliance is not intended for use by persons (including children) with reduced physical and sensory conditions or lack of experience and knowledge, unless they have been given supervision or instruction concerning use of the appliance by a person responsible for their safety.
- Make sure that small children and pets do not climb inside the drum. To avoid this, please check into the drum before using.
- Any objects such as coins, safety pins, nails, screws, stones or any other hard, sharp material can cause extensive damage and must not be placed into the machine.
- In order to avoid danger of fires caused by excessive drying, do not use appliance to dry the following items: Cushions, quilts etc. (these items accumulate heat).
- Items such as foam rubber (latex foam), shower caps, waterproof textiles, rubber backed articles and clothes or pillows fitted with foam rubber pads should not be dried in the tumble dryer.
- Always unplug the appliance after use, cleaning and maintenance.
- Under no circumstances should you attempt to repair the machine yourself. Repairs carried out by inexperienced persons may cause injury or serious malfunctioning. Contact your local Service Centre. Always insist on genuine spare parts.
- Items that have been soiled with substances such as cooking oil acetone, petrol, kerosene, spot removers, turpentine, waxes and wax removers should be washed in hot water with an extra amount of detergent before being dried in the tumble dryer.
- **Danger of explosion:** Never tumble dry items that have been in contact with inflammable solvents (petrol, methylated spirits, dry cleaning fluid and the like). As these substances are volatile, they could

cause an explosion. Only tumble dry items washed with water.

- **Risk of fire:** items that have been spotted or soaked with vegetable or cooking oil constitute a fire hazard and should not be placed in the tumble dryer.
- If you have washed your laundry with stain remover you must execute an extra rinse cycle before loading your tumble dryer.
- Please make sure that no gas lighters or matches have accidentally been left in pockets of garments incase they are loaded into appliance



Warning!

- **Risk of fire! Never stop a tumble dry before the end of the drying cycle unless all items are quickly removed and spread out so that the heat is dissipated.**
- **Lint must not be allowed to accumulate around the tumble dryer.**

-
- **Risk of electric shock!** Do not spray down the appliance with jets of water.
 - The final part of a tumble dryer cycle occurs without heat (cool down cycle) to ensure that the items are left at a temperature that ensures that items will not be damaged.
 - The tumble dryer is not to be used if industrial chemicals have been used for cleaning.
 - Ensure you have good ventilation in the installation room to avoid the back flow of gases into the room from appliances burning other fuels, including open fires.

Installation

- This appliance is heavy. Care should be taken when moving it.
- When unpacking the appliance, check that it is not damaged. If in doubt, do not use it and contact the Service Centre.
- All packaging must be removed before use. Serious damage can occur to the product and to property if this is not adhered to. See relevant section in the user manual.
- Any electrical work required to install this appliance should be carried out by a qualified electrician or competent person.
- If the machine is situated on a carpeted floor, please adjust the feet in order to allow air to circulate freely under the appliance.
- After having installed the appliance, check that it is not pressing or standing on its electrical supply cable.
- If the tumble dryer is placed on top of a washing machine, it is compulsory to use the stacking kit (optional accessory).

Use

- This appliance is designed for domestic use. It must not be used for purposes other than those for which it was designed.
- Only wash fabrics which are designed to be machine dried. Follow the instructions on each garment label.
- Do not dry unwashed items in the tumble dryer.
- Do not overload the appliance. See the relevant section in the user manual.
- Clothes which are dripping wet should not be placed in the dryer.

- Garments which have been in contact with volatile petroleum products should not be machine dried. If volatile cleaning fluids are used, care should be taken to ensure that the fluid is removed from the garment before placing in the machine.
- Never pull the power supply cable to remove the plug from the socket; always take hold of the plug itself.
- Never use the tumble dryer if the power supply cable, the control panel, the working surface or the base are damaged so that the inside of the tumble dryer is accessible.
- Fabric softeners, or similar products should be used as specified by the fabric softener instructions.
- **Caution - hot surface** : Do not touch the door light cover surface when the light is switched on.
(Only dryers equipped with internal drum light)

Child safety

- This machine is not intended for use by young children or infirm persons without supervision.
- Children often do not recognise the hazards associated with electrical appliances. Children should be supervised to ensure that they do not play with the appliance.



Warning!

- Danger of suffocation! The packaging components (e.g. plastic film, polystyrene) can be dangerous to children - Keep them out of children's reach.
-
- Keep all detergents in a safe place out of children's reach.

- Make sure that children or pets do not climb inside the drum.

Environmental tips

- In the dryer, laundry becomes fluffy and soft. Fabric softeners are not therefore needed when washing.
- Your dryer will function most economically if you:
 - Always keep the ventilation slots on the base of the dryer unobstructed;
 - Use the loading volumes specified in the programme overview;
 - Ensure you have good ventilation in the installation room;
 - Clean the micro-fine filter and fine strainer after each drying cycle;
 - Spin the laundry well before drying.



Energy consumption depends on spinning speed set in washing machine. Higher spinning speed - lower energy consumption.

Environmental information

The packaging materials are environmentally friendly and can be recycled. The plastic components are identified by markings, e.g. >PE<, >PS<, etc. Please dispose of the packaging materials in the appropriate container at the community waste disposal facilities.

Important! The heat pump of your tumble dryer contains a closed refrigerant circuit filled with a refrigerant which is free from fluoro-chloro-hydrocarbons. The refrigerant circuit in the heat pump must not be damaged.



Warning! When a unit is no longer being used:

- Pull the plug out of the socket.
 - Cut off the cable and plug and dispose of them.
 - Dispose of the door catch. This prevents children from trapping themselves inside and endangering their lives.
-

The symbol  on the product or on its packaging indicates that this product may not be treated as household waste. Instead

it should be taken to the appropriate collection point for the recycling of electrical and electronic equipment. By ensuring this product is disposed of correctly, you will help prevent potential negative consequences for the environment and human health, which could otherwise be caused by inappropriate waste handling of this product. For more detailed information about recycling of this product, please contact your local council, your household waste disposal service or the shop where you purchased the product.

Contents

For the user

Important safety information	2
Description of the appliance	7
Control panel	8
Before first use	8
Programme chart	9
Sorting and preparing laundry	10
Daily use	11
Switching machine on	11
Door opening and laundry loading	11
Selecting the programme	11
Delicate	11
Intensive	12
Anti-crease	12
Alarm	12
Time	13
Delay start	13
Setting child lock	13
Starting the programme	14
Changing programme	14
Putting in extra items or taking items out before end of programme	14
Drying cycle complete / removing laundry	15
Drying rack	15
Maintenance and cleaning	17
Cleaning fluff filter	17
Cleaning the door seal	18
Emptying the water reservoir	18
Cleaning heat exchanger filters	19
Cleaning the drum	21
Clean operating screen and housing	21
What to do if ...	21
Machine settings	23

For the installer

Technical information	24
Installation	24
Transporting the appliance	24
Appliance positioning	25
Removing transport safety packaging	25
Electrical connection	26
Door reversal	27
Drying rack unpacking	28
Repairs - after sales service	29

Guide to use the instruction manual

The following symbols will be found in the text to guide you throughout the instructions:



Safety instructions



Hints and tips



Environmental information

Description of the appliance

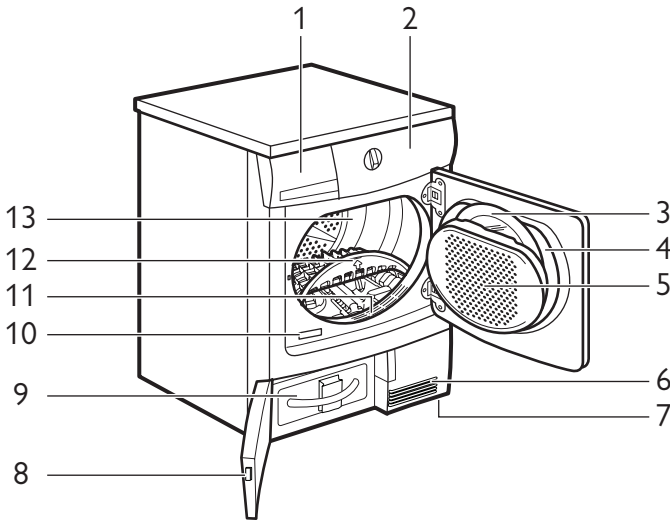

- | | | | |
|----------|---------------------------|-----------|-----------------------------------|
| 1 | Water reservoir | 8 | Push button for base door opening |
| 2 | Control panel | 9 | Heat exchanger cover |
| 3 | Fine fluff filter | 10 | Rating plate |
| 4 | Loading door (reversible) | 11 | Fluff filter |
| 5 | Course fluff filter | 12 | Drying rack |
| 6 | Ventilation grille | 13 | Drum light |
| 7 | Adjustable feet | | |

Control panel

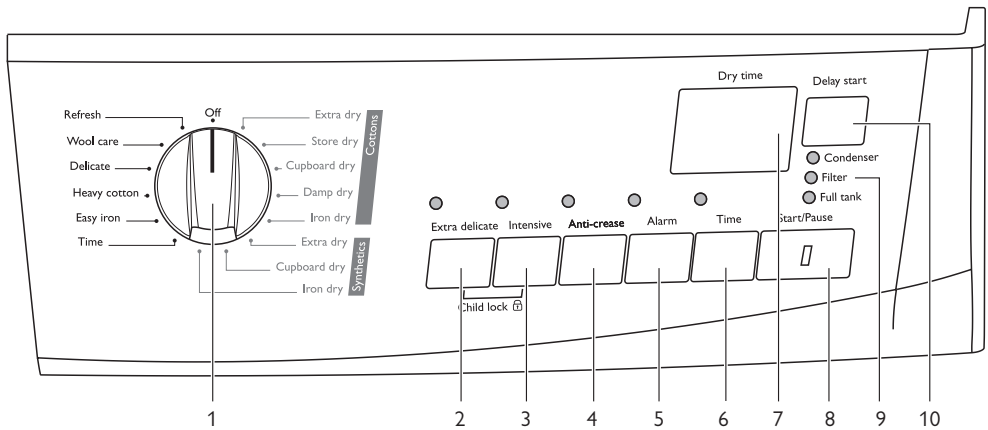

- 1** Programme selector and **Off** switch
- 2** **Delicate** button
- 3** **Intensive** button
- 4** **Anti-crease** button
- 5** **Alarm** button
- 6** **Time** button

- 7** Display (**Dry time**)
- 8** **Start/Pause** button
- 9** Warning lights: **Condenser, Filter, Full tank**
- 10** **Delay start** button

Before first use

In order to remove any residues which may have been produced during production, wipe the dryer drum with a damp cloth or carry out a brief drying cycle (ca. 30 min.) with damp cloths in the machine.

At the beginning of drying cycle (3-5 min.) there could be a slightly higher sound level. It is because of start of the compressor that is normal for compressor powered appliances such: refrigerators, freezers .

Programme chart

Programmes	max. load (weight when dry)	Additional functions/options					Application/properties	
		Delicate	Intensive	Anti-crease	Alarm	Time		Delay start
Cottons Extra dry	7 kg	-	•	•	•	-	•	To dry thick or multi-layered fabrics, e.g. terry towelling items, bathrobes, cottons.
Cottons Store dry	7 kg	-	•	•	•	-	•	To dry thick fabrics, e.g. terry towelling items, towels, cottons.
Cottons Cupboard dry	7 kg	-	•	•	•	-	•	To dry fabrics of even thicknesses, e.g. terry towelling items, knitwear, towels, cotton shirts.
Cottons Damp dry	7 kg	-	•	•	•	-	•	To dry thin textiles which are still to be ironed, e.g. knitted item, cotton shirts.
Cottons Iron dry	7 kg	-	•	•	•	-	•	To dry normal thickness cotton or linen laundry, e.g. bedding, table linen.
Synthetics Extra dry	3 kg	•	•	•	•	-	•	To dry thick or multi-layered fabrics, e.g. pullovers, bedding, table linen.
Synthetics Cupboard dry	3 kg	•	•	•	•	-	•	To dry thin fabrics which are not ironed, e.g. easy care shirts, table linen, socks, lingerie with bones or wires.
Synthetics Iron dry	3 kg	•	•	•	•	-	•	To dry thin fabrics which are also to be ironed, e.g. knitwear, cotton shirts.
Mix	3 kg	-	•	•	•	-	•	To dry cotton and synthetic fabrics, uses low temperature.
Time	7 kg	-	-	•	•	•	•	To dry the laundry with the time set by the user.
Heavy cotton	7 kg	-	•	•	•	-	•	To dry leisure clothes, such as jeans, sweat-shirts, etc., of different material thicknesses (e.g. at the neck, cuffs and seams).
Easy iron	1 kg (or 5 shirts)	-	•	•	•	-	•	To dry easy care cloths such as shirts and blouses. After this programme the cloths iron easiest. To have good result, we recommend to shake the wet cloths and put straight in the tumble dryer. After the programme end, remove the cloths and put on the cloths hanger.
Delicate	2 kg	-	•	•	•	-	•	To dry baby clothes e. g. jumpers.





Programmes	max. load (weight when dry)	Additional functions/options						Application/properties
		Delicate	Intensive	Anti-crease	Alarm	Time	Delay start	
Wool ¹⁾	1 kg	-	-	-	•	•	•	To dry the cloths made of wool. With this programme you must set the time with the Time function. We recommend to remove the cloths immediately after the programme end.

1) To dry with the rack only.

Sorting and preparing laundry

Sorting laundry

- Sort by fabric type:
 - Cotton/linen for programmes in *Cottons* programme group.
 - Mixtures and synthetics for programmes in *Synthetics* programme group.
- Sort by care label: The care labels mean:

	Drying in the tumble dryer possible in principle
	Drying at normal temperature
	Drying at reduced temperature
	Drying in the tumble dryer not possible

Important! Do not place in the appliance any wet laundry which is not specified on the care label as being suitable for tumble-drying.

This appliance can be used for all wet laundry items which are labelled as suitable for tumble-drying.

- Do not dry new, coloured textiles together with light-coloured laundry items. Textile colours may bleed.
- Do not dry cotton jersey and knitwear with the *Extra* programme. Items may shrink!
- Wool and wool-like textiles can be dried using the *Wool care* programme.

Preparing laundry

- To avoid laundry becoming tangled: close zips, button up duvet covers and tie loose ties or ribbons (e.g. of aprons).
- Empty pockets. Remove metal items (paper clips, safety pins, etc).
- Turn items with double-layered fabrics inside out (e.g. with cotton-lined anoraks, the cotton layer should be outermost). These fabrics will then dry better.

Important! Do not overload the appliance. Observe max. loading volume of 7 kg.

Daily use

Switching machine on

Turn the programme selector to any programme. The machine switches on. When the loading door is open, the internal lamp illuminates the drum.

Door opening and laundry loading

1. Open loading door:
Push against the loading door (push point)

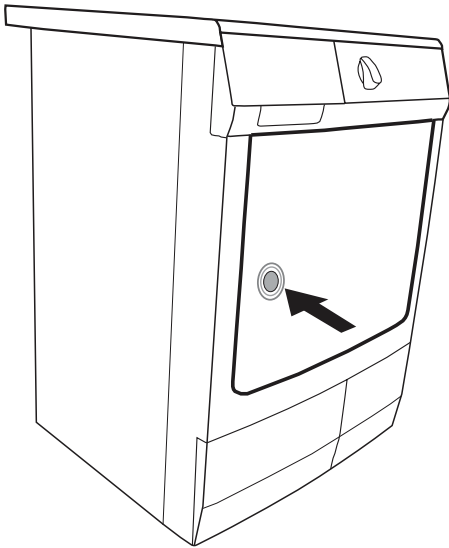

2. Load your laundry (do not force it in).



Caution! Do not jam laundry in between the loading door and rubber seal.

3. Close loading door securely. Lock must audibly lock.

Selecting the programme

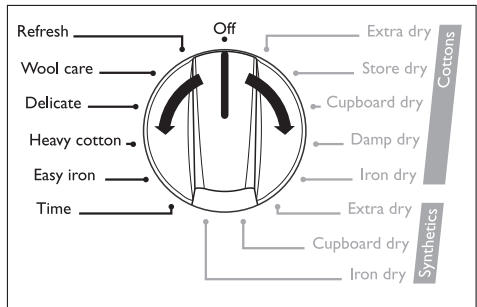

Use the programme selector to set the programme you require. The estimated time to end of the programme appears in the LCD in h:mm format (hours:minutes). During the cycle time elapses by steps of one minute; less than 1 hour the leading zero is not shown (e.g. "59", "5", "0").

Delicate

Extra delicate cycle is a programme specially designed for drying sensitive fabrics with the care label and for temperature-sensitive textiles (e.g. acrylic, viscose). The programme is executed with reduced heat. To activate it:

1. Choose the drying programme.

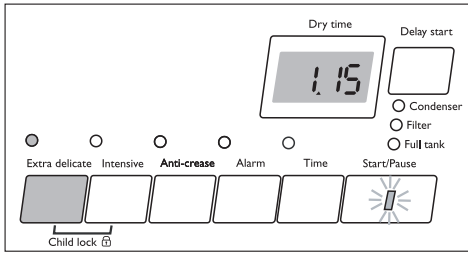

2. Press the *Delicate* button - the LED above is on.
To deselect the function press the *Delicate* button again. LED above is off.

Intensive

If the laundry is still damp after a standard drying programme, you can increase the drying result by using the *Intensive* function.

1. Choose the drying programme.

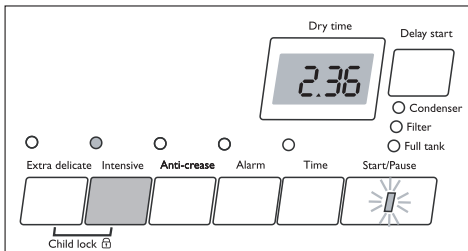

2. Press the *Intensive* button - the LED above is on.
To deselect the function press the *Intensive* button again. The LED above is off.

Anti-crease

This function prolongs the anti-crease phase to 90 mins in total. The drum rotates in intervals during this phase. The laundry therefore remains relaxed and free of creases.

To activate it:

1. Choose the drying programme.
2. Press the *Anti-crease* button - the LED above is on.

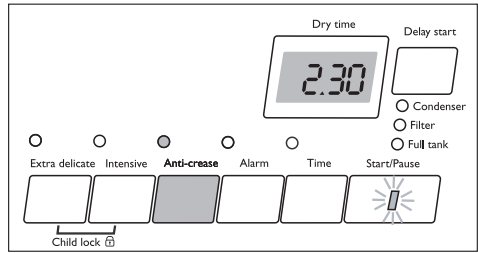

If this additional function is selected, the anti-crease phase at the end of the drying cycle is lengthened by 60 minutes. The laundry can be removed at any time during the anti-crease phase.

To deselect the function press the *Anti-crease* button again. The LED above is off. Press the *Anti-crease* button. A 90 minute anti-crease phase is set. The display now shows the anti-crease icon. If this additional function is selected, the anti-crease phase at the end of the drying cycle is lengthened by 60 minutes. The laundry can be removed at any time during the anti-crease phase.

Alarm

The appliance is supplied with the *Alarm* function deactivated.

When activated, the buzzer sounds:

- At the end of the cycle
- When the anti-crease phase starts or ends
- When the cycle is interrupted

To activate it:

1. Choose the drying programme.
2. Press the *Alarm* button - the LED above is on.

Delay start

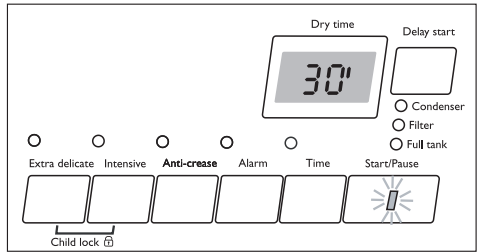

i With the *Delay start* button, you can delay the start of a programme by between 30 minutes (30') and a maximum of 20 hours (20h).

1. Select the programme and additional functions.
2. Press the *Delay start* button as many times as necessary until the required *Delay start* appears on the display, e.g. 12h if the programme is to be started in 12 hours.

i If the display is showing 20h and you press the button again, the time delay will be cancelled. The display will show 0' and then the duration of the selected programme.

3. To activate the delay timer, press the *Start/Pause* button. The amount of time remaining until the programme is set to start is continuously displayed (e.g. 15h, 14h, 13h, ... 30' etc).

Setting child lock

The child lock can be set to prevent a programme being accidentally started or a programme in operation being accidentally changed. The child lock function locks all buttons and the programme selector. The child lock can be activated or deactivated by

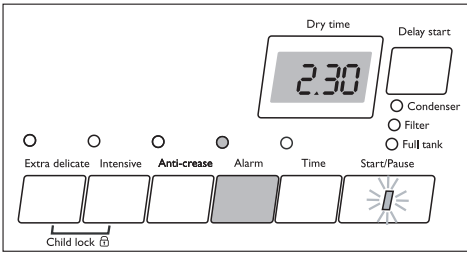

To deselect the function press the *Alarm* button again. The LED above is off.

Time

Use the *Time* button to select the programme duration after setting the *Time* programme. You can select a programme duration from 10 mins to 2 hrs in 10-minute steps.

1. Turn the programme selector to the *Time* programme. The flashing 10' above the *Time* button is on.

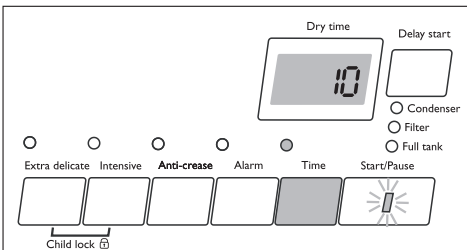

2. Press the *Time* button repeatedly until the desired programme duration is shown in the display, e.g. 20 for a programme of 20 minutes.

If the programme duration is not selected, the duration is automatically set to 10 mins.

holding down the *Delicate* and *Intensive* buttons simultaneously for 5 seconds.

-  – Before programme is started:
Appliance cannot be used
- After programme is started:
Programme in operation cannot be changed

The icon  appears in the display to indicate that the child safety device is activated.

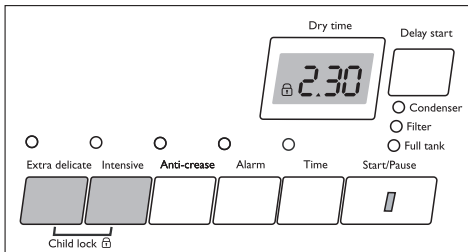

The child safety device is not deactivated once the programme comes to an end. If you want to set a new programme, you must first deactivate the child safety device.

Starting the programme

Press the Start/Pause button. The programme starts.

The programme progress is shown by elapsing *Dry time* on LCD.

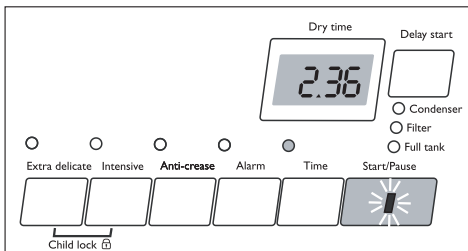

Changing programme

To change a programme which has been selected by mistake once the programme has started, first turn the programme selector to *Off* and then reset the programme.

-  The programme can no longer be changed directly once the programme has started. If however there is an attempt to change the programme on the programme knob, the programme progress display and the maintenance indicators flash. If an option button (excluding the *Alarm* button) is pressed, *Err* appears in the multidisplay.



The drying programme is not however affected by this (laundry protection).

Putting in extra items or taking items out before end of programme

1. Open loading door.

 **Warning!** Laundry and drum can become hot. **Risk of burns!**

2. Load or remove laundry items.
3. Close loading securely. Lock must audibly lock.
4. Press the Start/Pause button to continue the drying cycle.

Drying cycle complete / removing laundry

Once the drying cycle is complete, the display shows the anti-crease icon and flashing "0" as well as warning lamps: *Filter* and *Full tank*. If the *Alarm* button has been pressed, an acoustic signal sounds intermittently for about one minute.

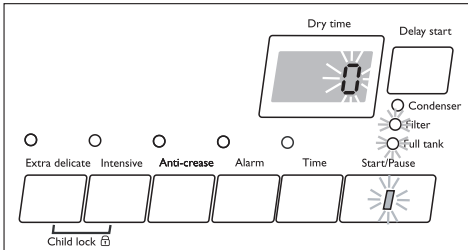

i The drying cycles are automatically followed by an anti-crease phase which lasts around 30 minutes. The drum rotates at intervals during this phase. This keeps the laundry loose and free of creases. The laundry can be removed at any time during the anti-crease phase. (The laundry should be taken out towards the end of the anti-crease phase at the latest to prevent creases from forming.) If *Anti-crease* function has been selected, the anti-crease phase is lengthened by 60 minutes.

1. Open door.
2. Before removing the laundry, remove fluff from the micro-fine filter. It is best to use a damp hand for this purpose. (See "Maintenance and cleaning" chapter.)
3. Remove laundry.
4. Turn the programme selector to *Off*.

Important! After each drying cycle:

- Clean the micro-fine filter and fine filter
 - Drain the condensed water container (See chapter "Maintenance and cleaning".)
5. Close the door.

Drying rack

Special equipment for gentle drying washable woollens and sport shoes. Incomparable for drying wet woollens - eliminated movement, protection from matting.

i For drying rack unpacking see *Installation* chapter.

Important! Before drying rack installation check the dryer drum. **It must be empty!** Sport shoes cannot be dry without the drying rack - drum damage.

Drying tips

- for the best drying result spread the woollens out loosely on the drying rack and roll it up
- do not squash and fold the woollens

Installation and use

1. Open the loading door.
2. Insert the rack carefully resting its two support brackets on the front of plastic flange.

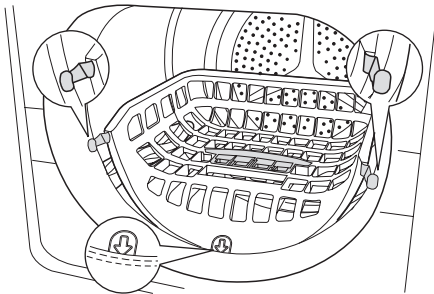
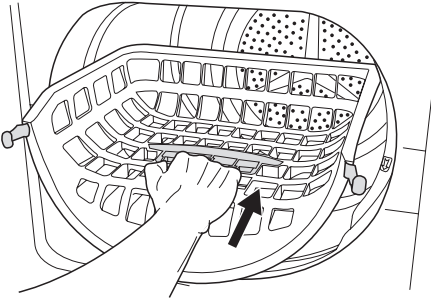

3. Place the woollens or pair of sport shoes on the rack.
4. Select the suitable rack drying programme and drying time.
5. Press the START/PAUSE button.
6. When cycle is finished open the loading door and remove the woollens or shoes.
7. Turn the programme selector to OFF.
8. Take out the drying rack of the drum.

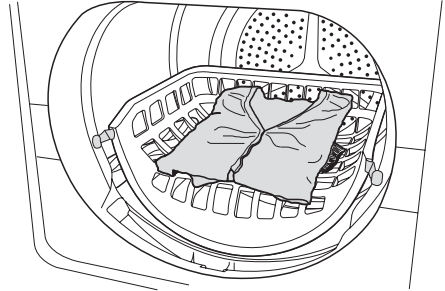

- open support and put sport shoes on it

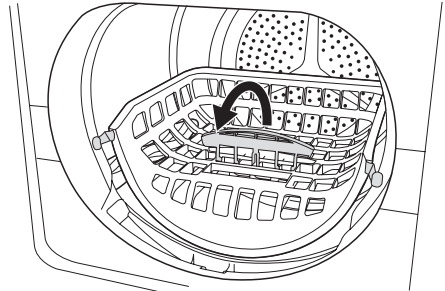

- the insoles should be placed beside the shoes on the drying rack and the shoelaces should be tied

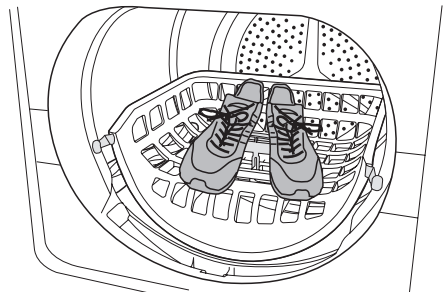

Maintenance and cleaning

Cleaning fluff filter

The filters collect all the fluff which accumulates during drying. To ensure that the dryer works perfectly, the fluff filters (micro-fine filter and fine strainer) must be cleaned after every drying cycle. The warning lamp *Filter* lights to remind you of this operation at the end of each cycle.

Caution! Never operate the dryer without fluff filters or with damaged or blocked fluff filters.

1. Open loading door
2. Use a damp hand to clean the micro-fine filter, which is built into the lower part of the loading aperture.

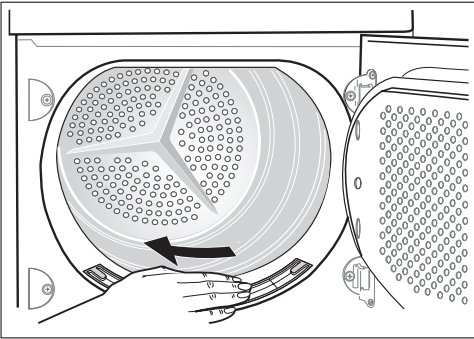

3. After a period of time, a gleam due to detergent residue on laundry forms on the filters. When this occurs, clean the filters with warm water using a brush. Remove the filter from the door pulling it out. (It can be positioned with the locating spur facing to the left or to the right). After cleaning do not forget to put it back.

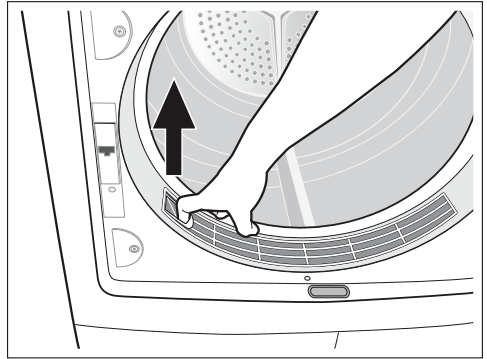

4. Push down the unlock button on the large mesh filter. The large mesh filter pops up.

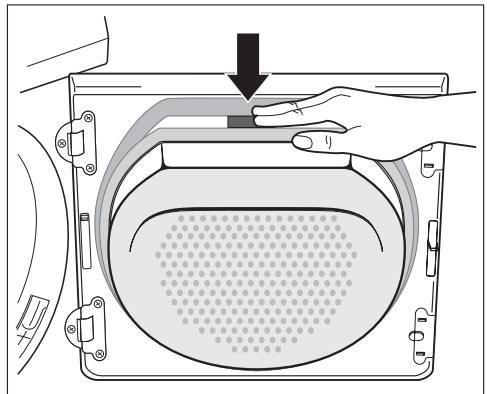

5. Take out fine filter.

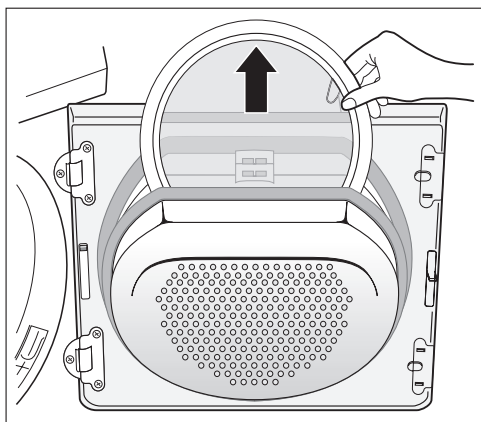

6. Remove the fluff from fine filter. It is best to use a damp hand for this purpose.

i **Clean the entire filter area**

The filter area does not have to be cleaned after every drying cycle, but should be checked regularly and cleaned of fluff if necessary.

7. To do this, grip the top of the large mesh filter and pull it forwards until it comes loose from the two brackets.

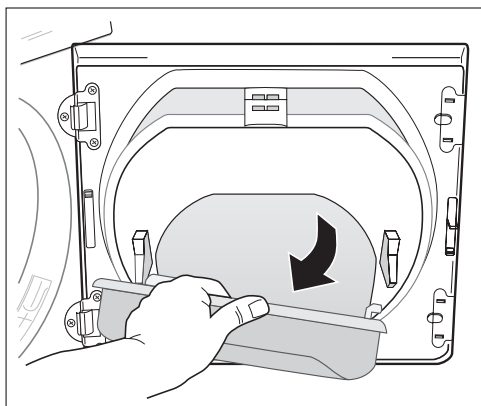

8. Remove fluff from the entire filter area. It is best to use a vacuum cleaner for this purpose.

9. Press both journals of the large mesh filter into the brackets on the loading door until they snap into place.
 10. Re-insert fine filter.
 11. Press against the large mesh filter until it locks into the interlock.

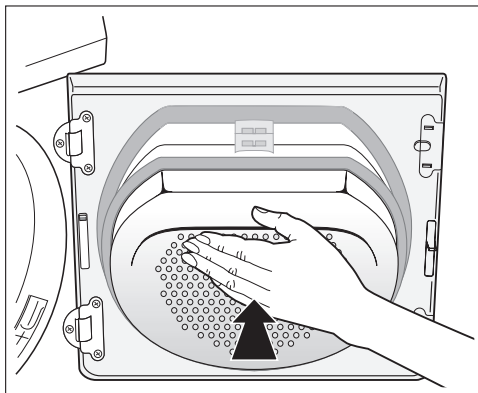

- i** If the fine filter is not fitted, the large mesh filter will not snap into place and the loading door cannot be closed.

Cleaning the door seal

Wipe the door seal with a damp cloth immediately after the drying cycle has finished.

Emptying the water reservoir

Empty the water reservoir after every drying cycle.

If the water reservoir is full, an active programme will break off automatically and the warning lamp *Full tank* lights. In order to continue the programme, the water reservoir must first be emptied.



Warning! The condensed water is not suitable for drinking or for preparing foodstuffs.



The condensed water can be used as distilled water, e.g. for steam ironing. However it must first be filtered (e.g. with a coffee filter) to remove any residue and small pieces of fluff.

1. Take out drawer containing water reservoir completely **1** and pull up the water reservoir's drainage pipe as far as it will go **2**.

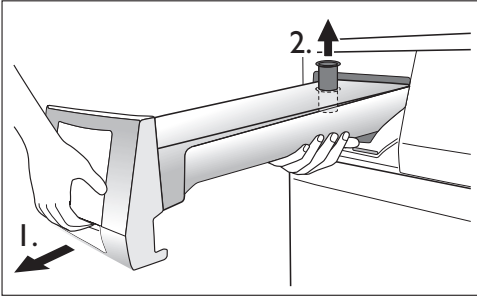

2. Pour the condensed water out into a basin or similar receptacle.

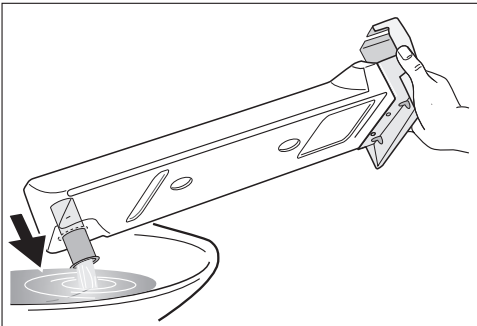

3. Slide the outlet connections in and refit the water reservoir.
If the programme has been interrupted as a result of the water reservoir being full: Press the *Start/Pause* button to continue the drying cycle.



The water reservoir has a volume of approx. 4 litres.

Cleaning heat exchanger filters

If the warning lamp *Condenser* lights, the heat exchanger fluff filters in the base of the appliance must be cleaned, i.e. after each 3 drying cycles. Both filters are located in the appliance base.



Water can collect in the filter housing therefore it is normal for the heat exchanger fluff filters to become wet.

Important!

- Never operate the dryer without the fluff filters.
- Clogged filters cause higher energy consumption (drying cycle elongation) and dryer damage.
- A dirty heat pump can only be cleaned up by means of a costly process.

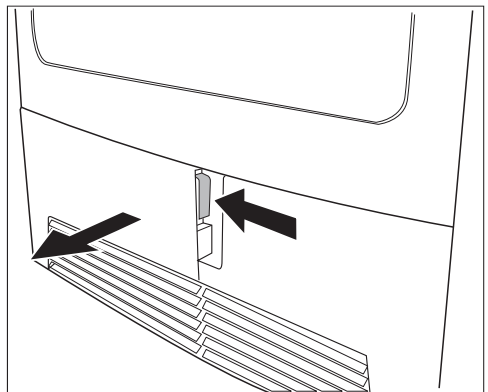

1. Open door in plinth: To do this, press the release button on the right and open the door in the plinth to the left.

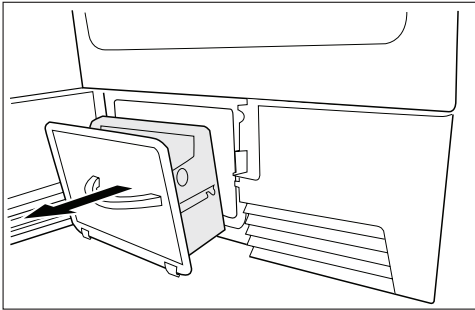

2. Pull the filter housing out of the base by the handle.

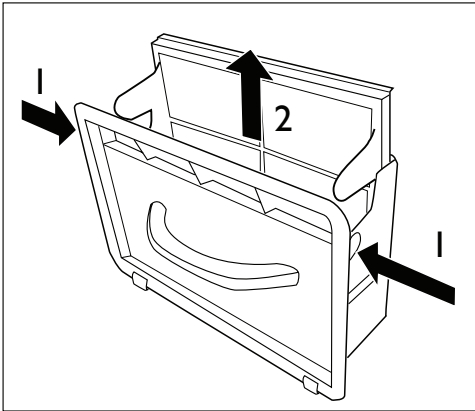

3. To clean the fluff filter: Remove filter from filter housing. To do this, press the pressure points on the sides and pull the filter frame up and out of the housing. Remove fluff from the fluff filter with a damp hand.

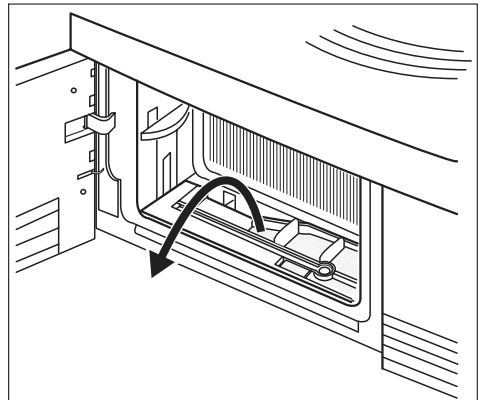
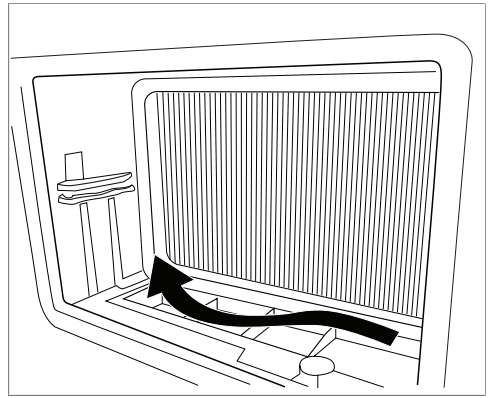

4. Use a damp hand to remove the fluff from the filter in the base. If necessary pull out and clean the filter with warm water using a wiper or brush. Clean the inside of the door, the fluff filter chamber and the rubber seals of fluff. Insert the fluff filter to the base.
5. Insert the fluff filter into the filter housing (it has to audibly lock) and slide it inside the filter chamber. Close the door in plinth. **Note:** If the fluff filter is not inserted in the filter housing, the filter housing cannot slide into the appliance base.

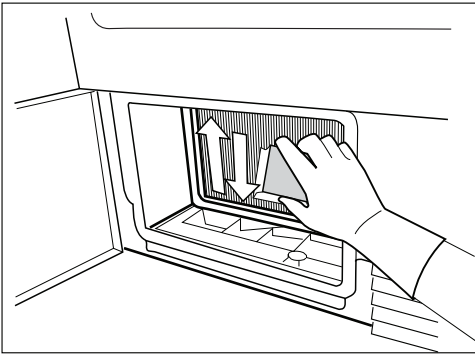

Lime in the water or cleaning agents may form a barely visible lining on the inside of the drum. The degree to which the laundry has been dried is then no longer detected reliably. The laundry is damper than expected when removed from the dryer. Use a standard domestic cleaner (e.g. vinegar-based cleaner) to wipe down the inside of the drum and drum ribs.

6. When necessary, approx. once every 6 months, remove the fluff from the heat exchanger using the sponge supplied. When doing this, please use rubber gloves.

Tip: The fluff can be removed more easily if it is first dampened (e. g. with a laundry dampener) or with help of vacuum cleaner.

Clean operating screen and housing



Caution! Do not use furniture cleaners or aggressive cleaning agents to clean the machine. Use a damp cloth to wipe down the operating screen and housing.

Cleaning the drum



Caution! Do not use abrasives or steel wool to clean the drum.

What to do if ...

Problem ¹⁾	Possible cause	Remedy
Dryer does not work.	Dryer not connected to mains supply.	Plug in at mains socket. Check fuse in fuse box (domestic installation).
	Loading door opened.	Close loading door
	The Start/Pause button not pressed.	Press the Start/Pause button.
Unsatisfactorily drying results.	Incorrect programme set.	Set suitable programme. ²⁾
	Fluff filters clogged.	Clean fluff filters. ³⁾
	Heat exchanger clogged.	Clean heat exchanger. ³⁾
	Max. loading exceeded.	Respect max. loading volume.
	Covered ventilation grill.	Uncover ventilation grill in base area.

	Residue inside the drum.	Clean the drum inside.
	High water hardness.	Set suitable water hardness ⁴⁾ .
Loading door does not close	Filters not locked in place.	Install fine filter and/or snap course filter into place.
Err (Error) on the LCD.	Attempt to change parameters after start of the programme.	Turn the dryer off and on. Set requested parameters.
No drum light	Programme selector in Off position.	Turn it to any programme.
	Defective light bulb.	Replace light bulb (see next section).
Abnormally elapsing time on LCD	Time to end is calculated on the basis of: type, volume and dampness of laundry.	Automatic process; this is not a machine fault.
Programme inactive	Full water reservoir.	Empty water reservoir ³⁾ , press Start/ Pause button.
Drying cycle to short	Small laundry volume./Too dry laundry for selected programme.	Select time programme or higher drying level (e.g. Extra dry).
Drying cycle to long ⁵⁾	Fluff filters clogged.	Clean fluff filters.
	To high loading volume.	Respect max. loading volume.
	Laundry insufficiently spun.	Spun adequately the laundry.
	Particularly high room temperature - no machine fault.	Lower the room temperature if possible.

1) In case of error message on the LCD (e.g. **ES1**): Switch the dryer off and on. Set programme. Press the Start/ Pause button. Does not work? - inform local service and quote the error code.

2) follow program recommendation - see *Programme chart* chapter

3) see *Maintenance and cleaning* chapter

4) see *Machine settings* chapter

5) Note: After around 5 hours the drying cycle ends automatically (see *Drying cycle complete* section).

Replacing the drum light

Only use a special bulb which is designed specially for dryers. The special bulb can be obtained from your local Service Force Centre.

Important! When the appliance is switched on, the interior lighting switches itself off after 4 minutes when the door is open.



Warning! Do not use standard bulbs! These develop too much heat and may damage the machine!



Warning! Before replacing the bulb, disconnect the mains plug; with a permanent connection: fully unscrew or deactivate the fuse.

1. Unscrew the cover above the bulb (this can be found directly behind the loading aperture, at the top; refer to "Description of machine" section.)

2. Replace the defective bulb.
 3. Screw cover back down.
- Check the correct positioning of o-ring gasket before screwing back the door light cover. Do not operate the dryer when missing o-ring gasket on door light cover.



Warning! For safety reasons, the cover must be screwed down tightly. If this is not done, the dryer must not be operated.

Machine settings

Alarm permanent on/off

The alarm is by default always off. To set permanent alarm on (off):

1. Turn the programme selector to any programme.
2. Press simultaneously the **Intensive** and **Anti-crease** buttons and hold down for approx. 5 seconds.

Adjusting the level of conductivity



Water contains, a variable quantity of limestone and mineral salts of which quantities vary according to geographical locations thus varying its conductivity values. Relevant variations of the conductivity of the water compared to those prefixed by the factory could slightly influence the residual humidity of the laundry at the end of the cycle. Your dryer allows you to regulate the sensitivity of the drying sensor based on conductivity values of the water. In order to establish the conductivity of the water in your area please contact your water board.

1. Turn the programme selector to any programme.

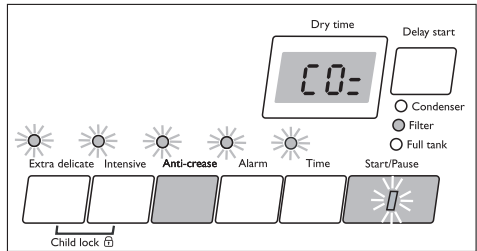

2. Press simultaneously the **Anti-crease** and **Start/Pause** buttons and hold down for approx. 5 seconds.
3. Press the **Start/Pause** button until you set desired level:

00_	low conductivity <300 µS/cm
00=	medium conductivity 300-600 µS/cm
00ε	high conductivity >600 µS/cm

4. To memorize setting press simultaneously the **Anti-crease** and **Start/Pause** buttons or turn knob to **Off** position

Technical information



height x width x depth	85 x 60 x 58 cm
drum volume	108 l
depth with the load door opened	109 cm
adjustable height	1.5 cm
the appliance weight	59 kg
maximum load volume	7 kg
voltage	230-240 V
necessary fuse	13 A
total power	900 W
energy efficiency class	A
energy consumption kWh/cycle ¹⁾	1,58 kWh
annual energy consumption	104,4 kWh
type of use	Domestic
permitted ambient temperature	+ 5°C to + 35°C

1) 7 kg of cotton, centrifuged at 1000 rpm with reference to EN 61121

Installation

Transporting the appliance

Important! Only tip the appliance on its left side to transport (see illustration), if it cannot be transported in an upright position.

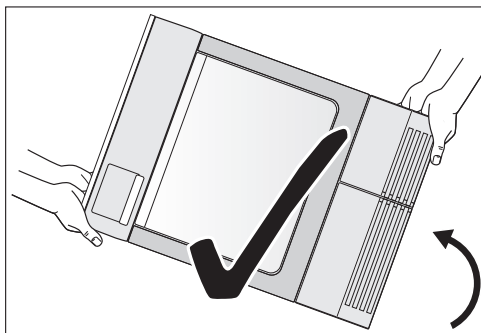

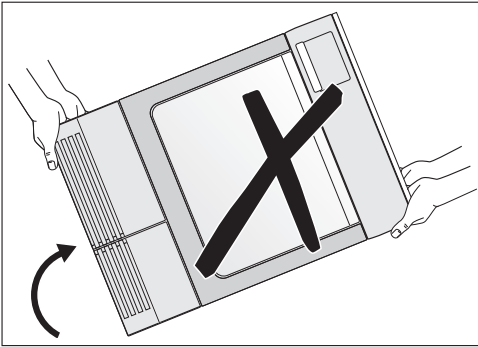

Important!

- The appliance should not be installed in an environment such as a unheated garage or outbuilding. The combination of high humidity and low ambient temperatures could affect the performance or the appliance and therefore invalidate your guarantee.
- The hot air emitted by the tumble dryer can reach temperatures of up to 60°C. The appliance must therefore not be installed on floors which are not resistant to high temperatures.
- When operating the tumble dryer, the room temperature must not be lower than +5°C and higher than +35°C, as it may affect the performance of the appliance.
- Should the appliance be moved, it must be transported vertically.
- The appliance must not be installed behind the lockable door, a sliding door or a door with a hinge on the opposite side to that of the appliance in such a way that a full opening of the dryer is restricted.

Appliance positioning

- It is recommended that, for your convenience, the machine is positioned close to your washing machine.
- The tumble dryer must be installed in a clean place, where dirt does not build up.
- Air must be able to circulate freely all round the appliance. Do not obstruct the front ventilation grille or the air intake grilles at the back of the machine.
- To keep vibration and noise to a minimum when the dryer is in use, it should be placed on a firm, level surface.
- Once in its permanent operating position, check that the dryer is absolutely level with the aid of a spirit level. If it is not, raise or lower the feet until it is.
- The feet must never be removed. Do not restrict the floor clearance through deeppile carpets, strips of wood or similar. This might cause heat built-up which would interfere with the operation of the appliance.

Removing transport safety packaging



Caution! Before use all parts of the transport packaging must be removed.

1. Open loading door
2. Pull off adhesive strips from inside machine on top of drum.

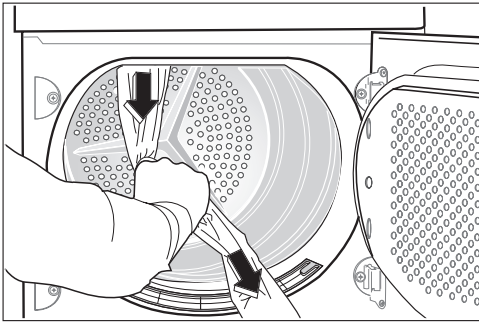

3. Remove foil hose and polystyrene padding from the machine.

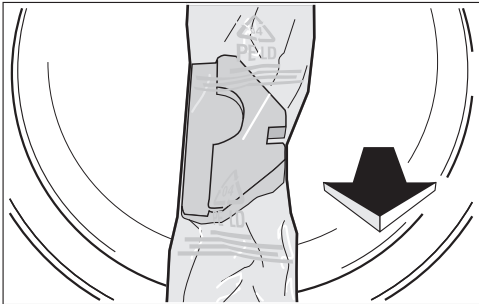

Warning! If the appliance was not transported in an upright position, leave it to stand for 12 hours before connecting it to the electricity supply and using it for the first time, so that the oil can flow back to the compressor. Otherwise the compressor could be damaged.

Electrical connection

Any electrical work required to install this appliance should be carried out by a qualified electrician or competent person.



Warning! THIS APPLIANCE MUST BE EARTHED. Should the appliance power supply cable need to be replaced, this must be carried out by a Service Force agent (see chapter: Repairs - after sales service). **The manufacturer declines any liability should this safety measure not be observed.**

Before switching on, make sure the electricity supply voltage is the same as that indicated on the appliance's rating plate. (See picture on page 6).

The appliance is supplied with a 13amp plug fitted. In the event of having to change the fuse in the plug supplied, a 13amp ASTA approved BS 1363/A fuse must be used. Should the plug need to be replaced for any reason, proceed as described below. The wires in the mains lead are coloured in accordance with the following code:

- Green and Yellow - Earth
- Blue - Neutral
- Brown - Live

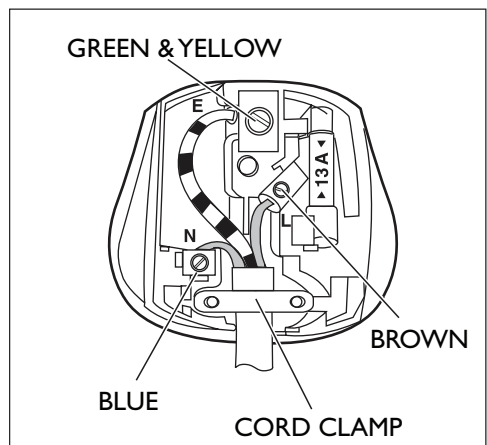

If you fit your own plug, the colours of the wires in the mains lead of your appliance may not correspond with the markings identifying the terminals in your plug.

Proceed as follows:

1. Connect the Green and Yellow (earth) wire to the terminal in the plug which is marked with the letter "E" or the earth symbol \perp or coloured green and yellow.
2. Connect the Blue (neutral) wire to the terminal in the plug which is marked with the letter "N" or coloured black.
3. Connect the Brown (live) wire to the terminal in the plug which is marked with the letter "L" or coloured red.
4. Upon completion there must be no cut, or stray strands of wire present and the cord clamp must be secure over the outer sheath.



Warning! A cut off plug inserted into a 13 amp socket is a serious safety (shock) hazard. Ensure that the cut off plug is disposed of safely.



Warning! The plug must still be accessible after the appliance has been installed.



Warning! The appliance should not be connected to the electrical supply by means of an extension cable.



Warning! The manufacturer declines any responsibility for damage or injury through failure to comply with the above safety precautions. Should the appliance power supply cable need to be replaced, this must be carried out by our Service Centre.



Warning! The power supply cable must be accessible after installing the machine.

Permanent connection

In the case of permanent connection it is necessary that you install a double pole switch between the appliance and the electricity supply (mains), with a minimum gap of 3mm between the switch contacts and of a type suitable for the required load in compliance with the current electrical regulations.

The switch must not break the yellow and green earth cable at any point.

Door reversal

To make it easier to load or unload the laundry, the door can be reversed.



Warning! The door must only be reversed by an authorised service engineer.

Please contact your nearest John Lewis branch who will give you details of your local Service Force Centre. The engineer will carry out the door reversal at your cost.

Drying rack unpacking



Caution! Before appliance use all packaging parts and drying rack must be removed from the drum. The inside of the drum must be clean.

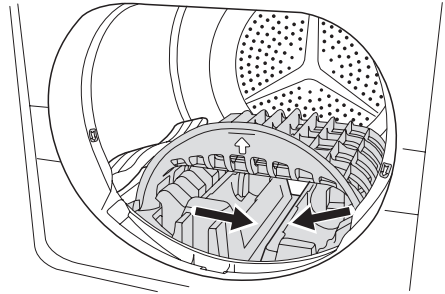

2. Lift slightly rack and take it carefully out from the drum.

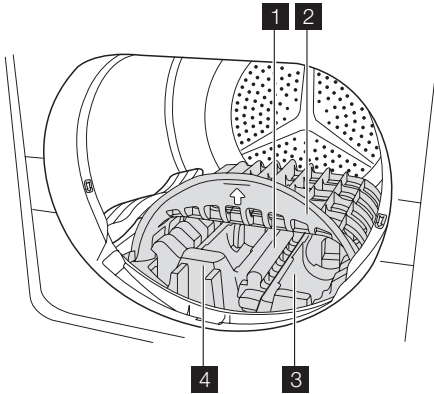

To unpack the rack:

1. Remove middle polystyrene part by pulling it.

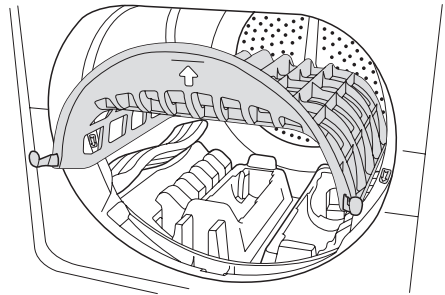

3. Remove right polystyrene part by pulling it.

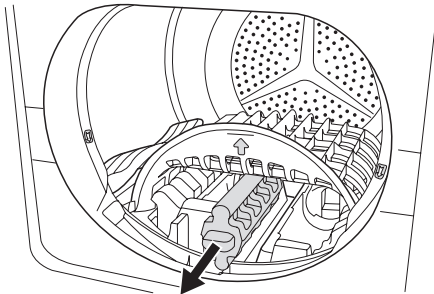

Loosen polystyrene parts 3 and 4.

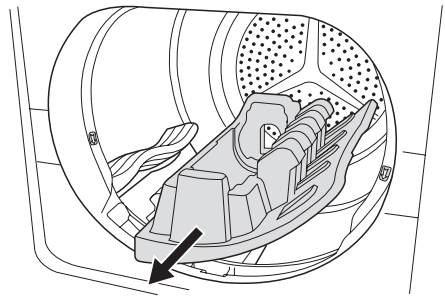

4. Remove left polystyrene part by pulling it.

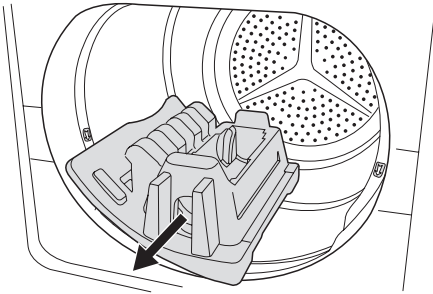

Repairs - after sales service

Your appliance comes with a three year warranty. If it is not working correctly refer to "Something not working". If a fault occurs which you can not resolve through following the advice and information contained within this instruction manual, the next step is to contact our extended warranty administrators on:

0844 871 7771

They will give you details for your local service engineer. Before calling out an engineer, please ensure you have read the details under the heading "Something not working".

When you contact your local service engineer you will need to give the following details:

1. Your name, address and post code
2. Your telephone number
3. Clear and concise details of fault
4. The purchase date as found on your receipt

5. The model and serial number of the appliance. So that you always have these numbers at hand, we recommend you to make a note of them here:

- Mod.....
- P.N.C.....
- S.N.....

IMPORTANT : If you call out an engineer to a fault listed under the heading "Something not working", or to repair a fault caused by incorrect use or installation, a charge will be made even if the appliance is under guarantee.

Spare parts

Always insist on genuine spare parts.

An authorised service engineer should service this product, and only genuine spare parts should be used. Under no circumstances should you attempt to repair the appliance yourself. Repairs carried out by inexperienced persons may cause injury or serious malfunctioning. Contact your local John Lewis branch.

John Lewis Partnership

171 Victoria Street
London SW1E 5NN
www.johnlewis.com

Free Manuals Download Website

<http://myh66.com>

<http://usermanuals.us>

<http://www.somanuals.com>

<http://www.4manuals.cc>

<http://www.manual-lib.com>

<http://www.404manual.com>

<http://www.luxmanual.com>

<http://aubethermostatmanual.com>

Golf course search by state

<http://golfingnear.com>

Email search by domain

<http://emailbydomain.com>

Auto manuals search

<http://auto.somanuals.com>

TV manuals search

<http://tv.somanuals.com>