

JLBICH605

Ceramic glass hob

Instruction manual

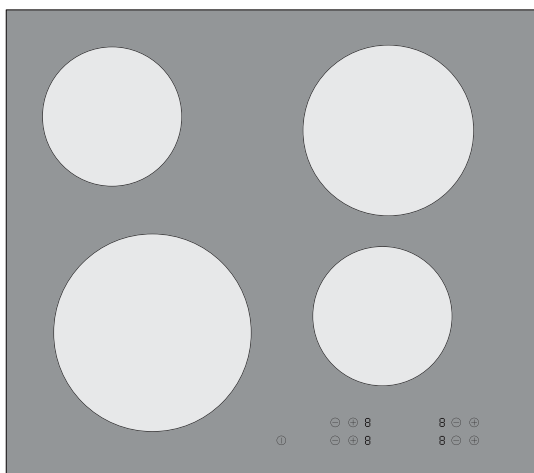

John Lewis

Safety information

It is most important that this instruction book should be retained with the appliance for future reference. Should the appliance be sold or transferred to another owner, or should you move house and leave the appliance, always ensure that the book is supplied with the appliance in order that the new owner can get to know the functioning of the appliance and the relevant warnings.

These warnings have been provided in the interest of safety. You **MUST** read them carefully before installing or using the appliance. If you are unsure of the meanings of these warnings contact the John Lewis branch from which you purchased the appliance.

General safety



Warning! Persons (including children) with reduced physical sensory, mental capabilities or lack of experience and knowledge must not use the appliance. They must have supervision or instruction for the operation of the appliance by a person responsible for their safety.

Child safety

- Only adults can use this appliance. Children must get supervision to make sure that they do not play with the appliance.
- Keep all packaging away from children. There is a risk of suffocation.
- Keep children away from the appliance when it is on.



Warning! Start the child safety device to prevent small children and pets from an accidental activation of the appliance.

Safety during operation

- Remove all packaging, stickers and layers from the appliance before the first use.
- Set the cooking zones to "off" after each use.
- Risk of burns! Do not put cutlery or saucepan lids on the cooking surface, as they can become hot.



Warning! Fire danger!

Overheated fats and oils can ignite very quickly.

Correct operation

- Always monitor the appliance during operation.
- Only use the appliance for domestic cooking tasks!
- Do not use the appliance as a work or a storage surface.
- Do not put or keep very flammable liquids and materials, or fusible objects (made of plastic or aluminium) on or near the appliance.

- Be careful when you connect the appliance to the near sockets. Do not let electricity bonds touch the appliance or hot cookware. Do not let electricity bonds tangle.
- Do not let cookware boil dry to prevent the damage to cookware and glass ceramics.
- Do not use the cooking zones with empty cookware or without cookware.
- Do not cover any part of the appliance with aluminium foil.

How to prevent a damage to the appliance

- If the objects or cookware fall on the glass ceramic, the surface can be damaged.
- Cookware made of cast iron, cast aluminium or with damaged bottoms can scratch the glass ceramic if you move them on the surface.



Warning! If there is a crack on the surface, disconnect power supply to prevent the electric shock.

Contents

For the User

Safety information 2

Description of the appliance 5

Operating the appliance 6

On and Off 6

Automatic Switch Off 6

The heat setting 7

The child safety device 7

Helpful hints and tips 7

Care and cleaning 8



What to do if... 9

For the Installer

Installation 11

Guide to use the instruction manual

The following symbols will be found in the text to guide you throughout the instructions:

- 7  Safety instructions
- 7  Hints and tips
- 8  Environmental information

Description of the appliance

Cooking surface layout

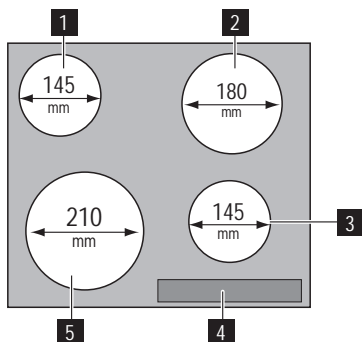

- 1** Single cooking zone 1200 W
- 2** Single cooking zone 1800 W
- 3** Single cooking zone 1200 W
- 4** Control panel
- 5** Single cooking zone 2300 W

Control panel layout

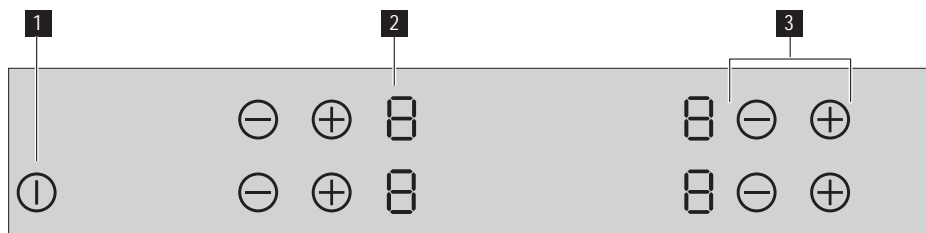







Use the sensor fields to operate the appliance.

	sensor field	function
1	ⓘ	starts and stops the hob
2	heat setting display	shows the heat setting or functions which are on
3	+ / -	increases or decreases the heat settings

Heat setting displays

Displays and sounds tell which functions are started

Display	Description
	The cooking zone is off
	The cooking zone operates
	There is a malfunction
	A cooking zone is still hot (residual heat)
	Lock/Child safety device is on
	The automatic switch off is active

Residual heat indicator



Warning!  Risk of burns from residual heat!

Operating the appliance

On and Off

Touch  for 1 second to start or stop the appliance.





Automatic Switch Off

The function stops the hob automatically if:

- all cooking zones are off .
- you do not set the heat setting after you start the hob.

- you cover a sensor field with an object (a pan, a cloth, etc.) for longer than 10 seconds. The sound operates some time and the hob stops. Remove the object or clean the control panel.
- you do not stop a cooking zone or change the heat setting after some time. See the table.  comes on.

Automatic Switch Off times

Heat setting				
Stops after	6 hours	5 hours	4 hours	1.5 hours

The heat setting

Touch \oplus to increase the heat setting. Touch \ominus to decrease the heat setting. The display shows the heat setting. Touch \oplus and \ominus at the same time to switch off.

The child safety device

This function prevents an accidental operation of the hob.

Starting the child safety device



- Start the hob with I . **Do not set the heat settings**.
- Touch \ominus of the two front cooking zones at the same time for 4 seconds. The symbol  comes on. Switch off the appliance.

Switching off the child safety device

- Start the hob with I . **Do not set the heat settings**.

- Touch \ominus of the two front cooking zones at the same time for 4 seconds. The symbol  comes on. Switch off the appliance.

Overriding the child safety device for one cooking session

- Start the hob with I . The symbol  comes on.
- Touch \ominus of the two front cooking zones at the same time for 4 seconds. The symbol  comes on. **Set the heat setting in less than 10 seconds.** You can operate the hob. When you stop the hob with I , the child safety device operates again.

Helpful hints and tips

Cookware

-  • The bottom of the cookware must be as thick and flat as possible.
- Cookware made of enamelled steel and with aluminium or copper bottoms can cause discoloration on glass ceramic surface.

Energy saving

-  • If possible, always put the lids on the cookware.
- Put cookware on a cooking zone before you start it.
- Stop the cooking zones before the end of the cooking time to use residual heat.
- The bottom of pans and cooking zones must have the same dimension.

Examples of cooking applications

The data in the table is for guidance only.

Heat setting	Use to:	Time	Hints
1	Keep cooked foods warm	as required	Cover
1-2	Hollandaise sauce, melt: butter, chocolate, gelatine	5-25 min	Mix occasionally
1-2	Solidify: fluffy omelettes, baked eggs	10-40 min	Cook with a lid on
2-3	Simmer rice and milkbased dishes, heating up ready-cooked meals	25-50 min	Add at least twice as much liquid as rice, stir milk dishes part way through
3-4	Steam vegetables, fish, meat	20-45 min	Add a few tablespoons of liquid
4-5	Steam potatoes	20-60 min	Use max. ¼ l water for 750 g of potatoes
4-5	Cook larger quantities of food, stews and soups	60-150 min	Up to 3 l liquid plus ingredients
6-7	Gentle fry: escalope, veal cordon bleu, cutlets, rissoles, sausages, liver, roux, eggs, pancakes, doughnuts	as required	Turn halfway through
7-8	Heavy fry, hash browns, loin steaks, steaks	5-15 min	Turn halfway through
9	Boil large quantities of water, cook pasta, sear meat (goulash, pot roast), deep fry chips		

Information on acrylamides

Important! According to the newest scientific knowledge, if you brown food (specially the one which contains starch), acrylamides can pose a health risk. Thus, we recommend that you cook at the lowest temperatures and do not brown food too much.

Care and cleaning

Clean the appliance after each use.

Always use cookware with clean bottom.



Warning! Sharp objects and abrasive cleaning agents will damage the appliance.

For your safety, do **not** clean the appliance with steam blasters or high-pressure cleaners.



Scratches or dark stains on the glass ceramic have no effect on how the appliance operates.

Removing the dirt:



1. – **Remove immediately:** melting plastic, plastic foil, and food containing sugar. Use a special glass ceramic

scraper. Put the scraper on the glass ceramic surface at an acute angle and slide the blade on the surface.

- **Stop the appliance and let it cool down** before you clean: limescale rings, water rings, fat stains, shiny metallic discolorations. Use a special cleaner for glass ceramic or stainless steel.

2. Clean the appliance with a damp cloth and some detergent.
3. At the end **rub the appliance dry with a clean cloth.**

What to do if...

Problem	Possible cause and remedy
You cannot start the appliance or operate it.	<ul style="list-style-type: none"> • You touched 2 or more sensor fields at the same time. Only touch one sensor field. • There is water or fat stains on the control panel. Clean the control panel • The child safety device operates . Stop the function. See the section “Child safety device”. • Start the appliance again and set the heat setting in 10 seconds.
The residual heat indicator does not come on.	The cooking zone is not hot because it operated only for a short time. If the cooking zone must be hot, speak to the after sales service.
A sound operates and appliance starts and stops again. After 5 seconds one more sound operates.	You covered  . Uncover the sensor field.
 comes on.	<ul style="list-style-type: none"> • The automatic switch-off operates. Stop the appliance and start it again. <p>Overheating protection for the cooking zone operates. Stop the cooking zone and start it again.</p>

Problem	Possible cause and remedy
E and a number come on.	<p>There is an error in the appliance.</p> <p>Disconnect the appliance from the electrical supply for some time.</p> <p>Disconnect the fuse from the electrical system of the house.</p> <p>Connect again. If E comes on again, speak to the after sales service.</p>

If you tried the above solutions and cannot repair the problem, speak to your dealer or the Customer Care Department. Give the data from the rating plate, three-digit-letter code for the glass ceramic (it is in the corner of the cooking surface) and an error message that comes on.

If you operated the appliance incorrectly, the servicing by a customer service technician or dealer will not be free of charge, even during the warranty period. The instructions about the customer service and conditions of guarantee are in the guarantee booklet.



Installation



Before the installation , note down this data from the rating plate:

- Model description (Modell).....
- Product number (Prod. Nr.)
- Serial number (Ser. Nr.)

You find the rating plate of the appliance on its lower casing.

Modell JLBICH605	Prod.Nr. 949 593 031 01	
Typ 58HAD54AO	220-240 V 50-60-Hz	6,5 kW
Made in Germany	Ser.Nr.	6,5 kW
JOHN LEWIS	 	

Safety instructions



Warning! You must read these!

Make sure that the appliance is not damaged because of transportation. Do not connect a damaged appliance. If it is necessary, speak to the supplier. Only an authorised service technician can install, connect or repair this appliance. Use only original spare parts.

Only use built-in appliances after you assemble the appliance into correct built-in units and work surfaces that align to the standards.

Do not change the specifications or modify this product. Risk of injury and damage to the appliance.

Fully obey the laws, ordinances, directives and standards in force in the country where you use the appliance (safety regulations, recycling regulations, electrical safety rules etc.)!

Keep the minimum distances to other appliances and units!

Install anti-shock protection, for example install the drawers only with a protective floor directly below the appliance!

Protect the cut surfaces of the worktop against moisture with a correct sealant!

Seal the appliance to the work top with no space left with a correct sealant!

Protect the bottom of the appliance from steam and moisture, e.g. from a dishwasher or oven!

Do not install the appliance adjacent to doors and below windows! If not, hot cookware can be hit off the hob when you open doors or windows.



Warning! Risk of injury from electrical current. Carefully obey the instructions for electrical connections.

- The electrical mains terminal is live.
- Make electrical mains terminal free of voltage.
- Install correctly to give anti-shock protection.
- Loose and incorrect plug and socket connections can make the terminal become too hot.
- A qualified electrician must install the clamping connections correctly.
- Use a strain relief clamp on cable.
- Use the correct mains cable of type H05BB-F Tmax 90°C (or higher) for a single-phase or two-phase connection.
- Replace the damaged mains cable with a special cable (type H05BB-F Tmax 90°C; or higher). Speak your local Service Force Centre.

The appliance must have the electrical installation which lets you disconnect the appliance from the mains at all poles with a contact opening width of minimum 3 mm. You must have correct isolation devices: line protecting cut-outs, fuses (screw type fuses removed from the holder), earth leakage trips and contactors.

Assembly

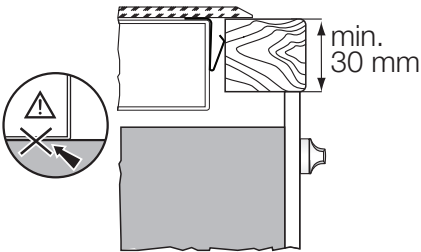
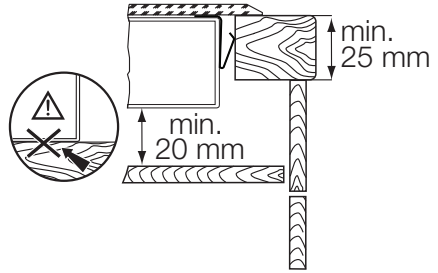
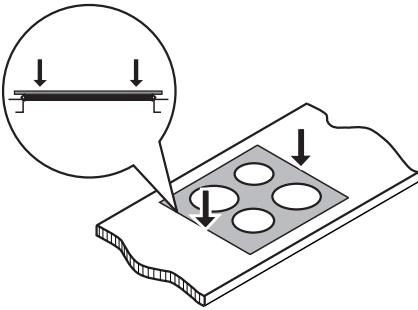
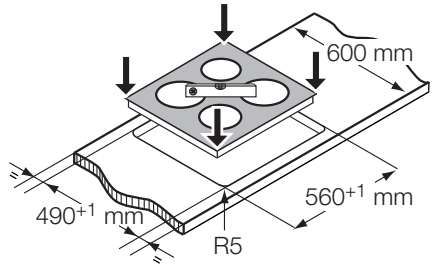
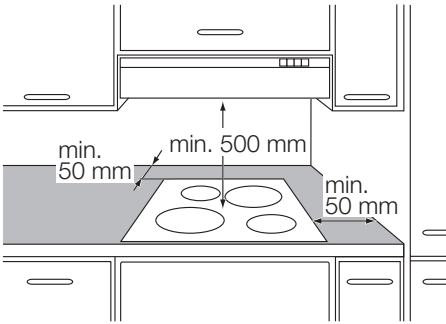

John Lewis Partnership

171 Victoria Street
London SW1E 5NN
www.johnlewis.com

Free Manuals Download Website

<http://myh66.com>

<http://usermanuals.us>

<http://www.somanuals.com>

<http://www.4manuals.cc>

<http://www.manual-lib.com>

<http://www.404manual.com>

<http://www.luxmanual.com>

<http://aubethermostatmanual.com>

Golf course search by state

<http://golfingnear.com>

Email search by domain

<http://emailbydomain.com>

Auto manuals search

<http://auto.somanuals.com>

TV manuals search

<http://tv.somanuals.com>