

JLBIDO906

Built-in double oven

Instruction manual

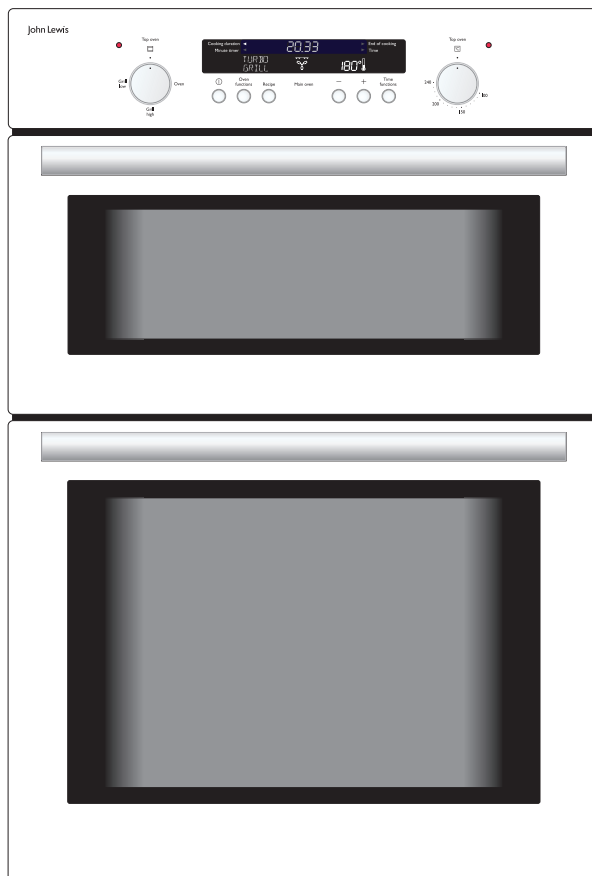

John Lewis

Important Safety Information



It is most important that this instruction manual should be retained with the appliance for future reference. Should the appliance be sold or transferred to another owner, or should you move house and leave the appliance, always ensure that the book is supplied with the appliance in order that the new owner can get to know the functioning of the appliance and the relevant warnings. These warnings have been provided in the interest of safety. You **MUST** read them carefully before use or installation by a qualified person. If you are unsure of the meanings of these warnings contact the John Lewis branch from which you purchased the appliance.

Installation

- The appliance must be installed according to the instructions supplied. The installation work must be undertaken by a qualified electrician or competent person.
- The appliance should be serviced by an authorised Service Engineer and only genuine approved spare parts should be used.
- The appliance must be installed in an adequately ventilated room.
- It is imperative that the appliance is left in the base to protect both the appliance and the floor.
- This appliance is heavy and care must be taken when moving it.
- Do not attempt to lift or move this appliance by the handles.
- All packaging, both inside and outside the appliance must be removed before the appliance is used.
- It is dangerous to alter the specifications or modify the appliance in any way.

Child Safety

- Do not allow children to play with any part of the packaging.
- Do not allow children to sit or climb on the drop down doors.
- This appliance is not intended for use by children and other persons whose physical, sensory or mental capabilities or lack of experience and knowledge prevents them from using the appliance safely without supervision or instruction by a responsible person to ensure that they can use the appliance safely.
- Children should be supervised to ensure that they do not play with the appliance.



Caution

Accessible parts may be hot when the grill is in use. Young children should be kept away.

Use

- This appliance is not intended to be operated by means of an external timer or separate remote control system.
- This appliance has been designed for domestic use to cook edible foodstuffs only and must not be used for any other purposes.
- Take great care when heating fats and oils, as they will ignite if they become too hot.
- Never place plastic or any other material which may melt in or on the oven.
- Always support the grill pan when it is in the withdrawn or partially withdrawn position.
- Always use oven gloves to remove and place food in the oven.
- During use the appliance becomes hot. Care should be taken to avoid touching heating elements inside the oven.
- Ensure that all vents are not obstructed to ensure ventilation of the oven cavity.
- Never line any part of the appliance with foil.
- Always stand back from the appliance when opening the doors to allow any build up of steam or heat to release.

- Stand clear when opening the drop down oven door. Do not allow it to fall open - support it using the door handle, until it is fully open.



Warning

Never leave the appliance unattended when the oven door is open.

- Do not place sealed cans or aerosols inside the oven. They may explode if they are heated.
- Ensure that all control knobs are in the off position when not in use.
- Do not stand on the appliance or on the open oven doors.
- Do not hang towels, dishcloths or clothes from the appliance or its handles.
- Do not use this appliance if it is in contact with water.
- Never operate it with wet hands.

Maintenance and Cleaning



Warning

For hygiene and safety reasons this appliance should be kept clean at all times. A build-up of fat or other foodstuff could result in a fire especially in the grill pan.

- Do not leave the cookware containing foodstuffs, e.g. fat or oil in the appliance in case it is inadvertently switched on.
- Always allow the appliance to cool before switching off at the wall prior to carrying out any cleaning / maintenance work.
- Only clean this appliance in accordance with the instructions given in this book.
- Never use steam or high-pressure steam cleaners to clean the appliance.



Environmental Information

After installation please dispose of the packaging with due regard for safety and the environment. Your local authority can arrange this.



The symbol  on the product or on its packaging indicates that this product may not be treated as household waste. Instead it shall be handed over to the applicable collection point for the recycling of electrical and electronic equipment. By ensuring this product is disposed of correctly, you will help prevent potential negative consequences for the environment and human health, which could otherwise be caused by inappropriate waste handling of this product. For more detailed information about recycling of this product, please contact your local city office, your household waste disposal service or the shop where you purchased the product.

Contents

For the user

Important safety information	2
Environmental information	2
Description of the appliance	4
The control panel	10
Before using the appliance	11
Setting the language	11
The timer	13 - 14
Operation	15
The dual grill	15
The top oven	15
The main oven	16
Main oven grill	16
Turbo grilling	17
Main oven conventional cooking	17
Main oven fan cooking	18
Pizza	18
Top heat/Base heat finishing	18 - 19
Keep warm	19
Defrost feature	19
Recipe function	20
Recipes	21 - 24
Safety and energy saving functions	25
Child safety lock	25
Grilling chart	26
Turbo grilling chart	27
Top oven cooking chart	28
Main oven cooking chart	29
Roasting chart	30
Hints and tips	31 - 32
Maintenance and cleaning	33 - 35
Something not working	36
Repairs – After sales service	37

For the installer

Installation	5
Technical specification	5
Electrical connections	5 - 7
Building in	8 - 9

Guide to use the Instruction Manual

The following symbols will be found in the text to guide you throughout the Instructions:



Safety Instructions



Hints and Tips



Environmental Information



This appliance complies with: European Council Directive 73/23/EEC.
EMC Directive 89/336/EEC. CE Marking Directive 93/68/EEC.
Energy Label Directive 2002/40/EC.

Description of the appliance

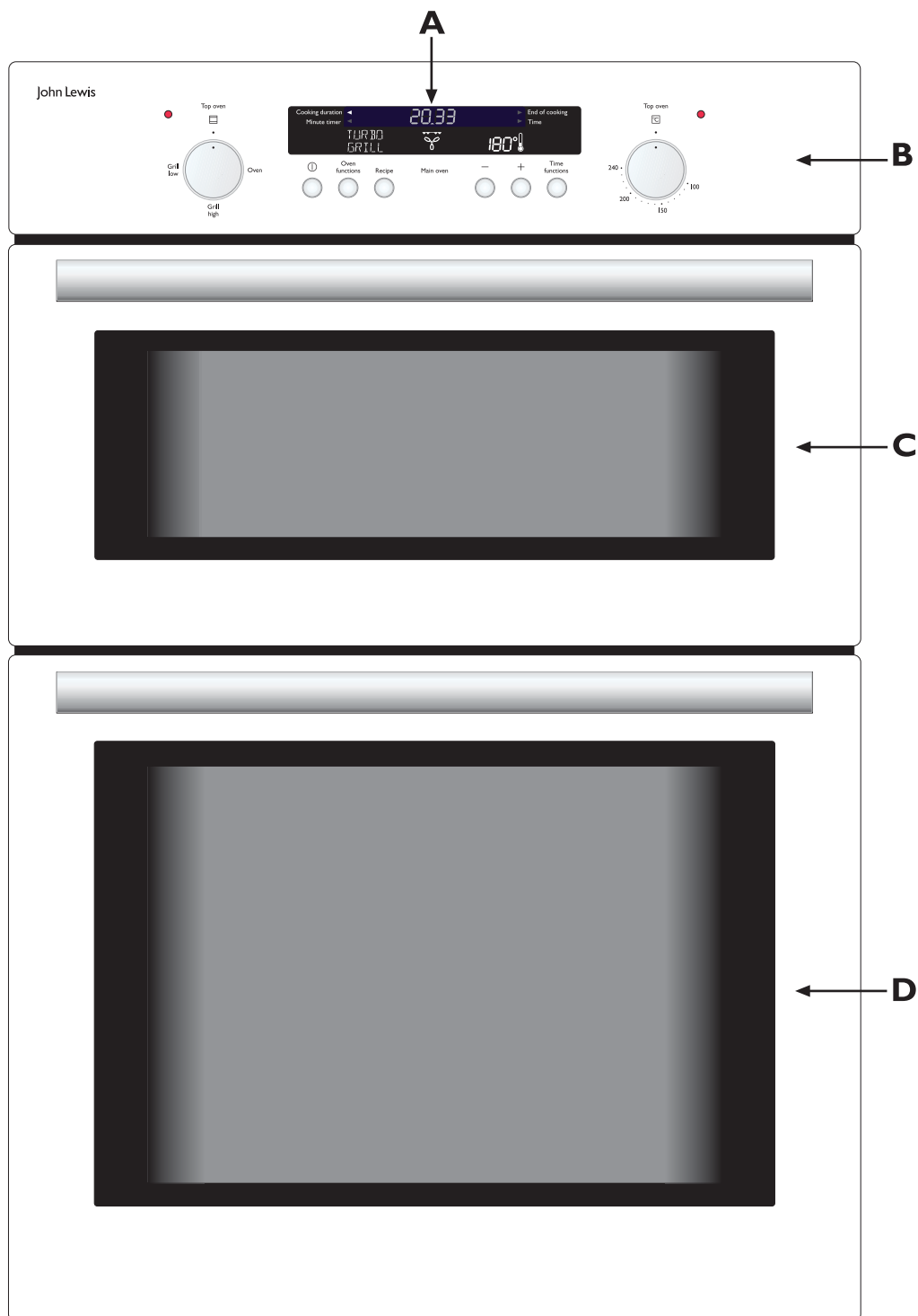

- A.** Timer / Electronic control display window
- B.** Control panel
- C.** Top oven / Dual grill
- D.** Main oven

Installation



It is dangerous to alter the specifications or attempt to modify this product in any way.



Care must be taken to ensure that the appliance does not stand on the electrical supply cable.



Any electrical work required to install this appliance should be carried out by a qualified electrician or competent person.

Technical details

Voltage	230-240 Volts AC 50Hz
Power consumption	5.9-6.4kW
Height:	888mm
Width:	592mm
Depth:	563mm (excluding handles and knobs)
Weight:	55Kg

Electrical connections

- This appliance must be earthed.
- Do not remove the screws from the earth tab extending from the oven mains terminal block
- Before connecting the appliance, make sure that the voltage of your electricity supply is the same as that indicated on the rating plate. This is usually situated on the front frame of the appliance and can be seen upon opening either the main or top oven door. Alternatively the rating plate may also be found on the back or top of some models (where applicable).
- Do not alter the electrical circuitry of this appliance.

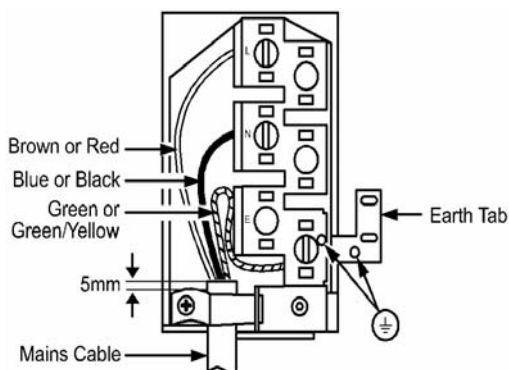

Things to note

- This appliance is designed to be fitted in cabinets of the recommended dimensions as shown (Recommended cabinet dimensions).
- If your cabinet interior dimension is between 565-570mm the oven may still be fitted. However, a minor modification to the cabinet will be required to reduce the aperture size down to 560-565 mm, to allow the product to be securely screwed into the cabinet.
- The dimensions given provide adequate air circulation around the unit within the cabinet, ensuring compliance with BS EN60-335.
- Enquiries regarding the installation of the cooker point, if required, should be made to your Regional Electricity Company to ensure compliance with their regulations.

- The appliance socket switch should be outside the cabinet but within 2m of the appliance to make it accessible to switch off the appliance in case of an emergency.
- To protect the hands, wear gloves when lifting the oven into its housing.

Warning

Do not lift the appliance by the handles.

Important

House circuit

Earth leakage and continuity tests must be carried out before the appliance is connected to the mains supply and re-checked after fitting.

Connection via	Min. size Cable/flex	Cable/flex type	Fuse
Cooker Control Circuit	6mm ²	PVC/PVC twin and earth	35 A (min)

Choice of electrical connections

- There are three possible ways to connect your appliance. In each case the appliance should be operated using at least 6mm² twin core and earth PVC insulated. Please choose from the most appropriate after reading the different methods: -
- a) By connecting the appliance to a cooker point (having a double pole isolating switch with at least 3mm contact separation in all poles and neutral) and protected with a fuse or miniature circuit breaker at your mains fuse box.

Important

Subject to Regional Electricity Companies regulations if you wish to connect the oven and hob to the power supply you may use one of the following two methods: -

- b) By connecting the appliance together with a hob directly to a cooker point(s). Having a double pole isolating switch with at least 3mm contact separation in all poles and neutral.
- c) If you wish to connect an oven and a hob to a cooker point you can by connecting the oven and hob separately to the cooker point. Oven and hob units should be separately connected to a cooker point.

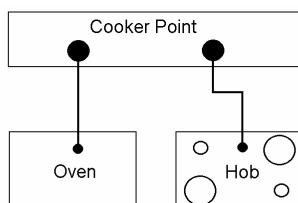

Important

It is good practice to:

- Fit an Earth Leakage Circuit Breaker to your house wiring.
- Wire your appliance to the latest IEE regulations.

To remove the mains terminal cover

- From the rear of the appliance, remove mains input terminal cover to gain access to terminal block.
- First remove retaining screw with a pozidrive screwdriver.

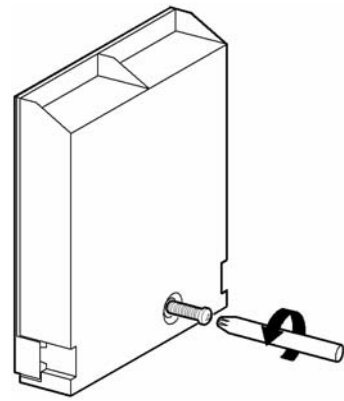

- Prise cover loose using screwdriver in position (1) then lever off with screwdriver in position (2) at either side.

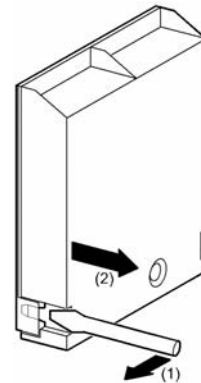

- Lift cover and remove screw from cable clamp.

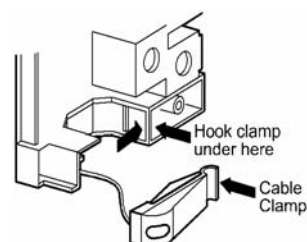

Connecting to the mains terminal



Warning

This appliance must be earthed.

- We recommend you use a new length of 6mm² twin core and earthed cable to ensure your safety.
- Make connection as shown below by proceeding as follows: -
- Pre-form wires to the appropriate shape to suit fitting into the mains terminal block.
- Strip inner insulation on wires using wire strippers.
- Twist the bared wires using pliers.
- Cut bared wires 10mm away from the end of the inner insulation. Where un-insulated Earth wires are used ensure they are suitably sheathed to leave 10mm bare wire to fit into the terminal.
- Clamp bare wires into the relevant terminal and check they are held by tugging each one in turn.
- Clamp the mains cable securely ensuring 5mm of the outer insulation is inside the terminal block and that the wires are not taught but not so slack as to cause any fouling.
- Place fuse/miniature circuit breaker in circuit and switch on at mains.

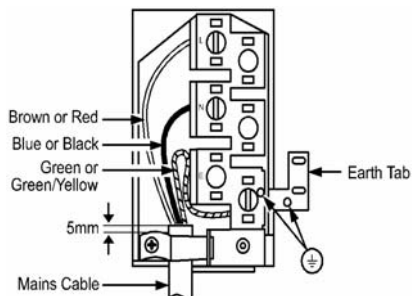

Checking electrical connections

Correct electrical connection can be confirmed when switching on the appliance, as the timer will be flashing.

Connecting to a hob or cooker point

- Either follow in general terms the instructions for connecting to the terminal block or refer to the hob suppliers installation instructions.



Warning

Feed the cable through the cabinet and arrange to route the cable away from the appliance which may become hot.

Building In

Preparing cabinet for fitting of oven

- Make sure that the cabinet is the correct size for the appliance to be fitted (Recommended cabinet dimensions).
- If the size is between 565-570mm, then the cabinet should be modified so that at the screw fixing points the recommended dimension of at least 560-565mm is maintained. The modification should ideally be localised to ensure that after screw fitment the oven is securely fixed into position.
- The cabinet must be stable and level by firmly securing it to the wall or floor. If necessary, make arrangements to ensure the shelf upon which the oven will rest is level.
- When the appliance is installed ensure a minimum gap of 2mm is maintained between the trim on the bottom edge of the appliance, and any corresponding door / panel underneath.

How to finish unpacking

- Place packed appliance next to the space in which it will be installed.
- Remove the appliance packing except for bottom tray, which should be left in position until the appliance is ready to be fitted into its cabinet.

i Important

It is imperative that the appliance is left in the base to protect both the appliance and the floor.

- Ensure the user is given these operating instructions.

i Important

Important: Switch off at the mains, miniature circuit breaker and if appropriate, remove fuse before commencing any electrical work.

Fitting into the cabinet

i Important

Ensure that the oven is switched off at the wall before any further work is carried out.

- Using a tape measure establish the internal width of the cabinet. Refer to recommend cabinet dimensions if greater than 565mm.

- Position the appliance in front of the cabinet.

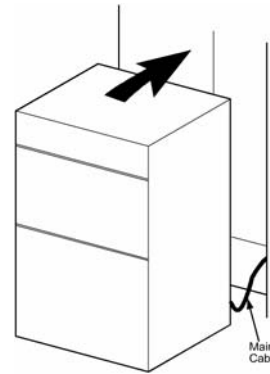

- Take out all oven furniture before installation to reduce the weight you need to lift. The oven door should be taped up to keep it closed whilst lifting.
- To place the appliance into the cabinetry follow the procedure below:

i Important

Two people will be required to carry out the lifting procedure.

! Warning

- **Do not attempt to lift this appliance by the handle(s).**
 - Each person should squat either side of the appliance.
 - Tilt the appliance so that your hands can support the underside of the appliance.
 - Keeping your back straight, raise the appliance to the correct height by straightening at the knees.
 - Rest the rear underside of the appliance on the cabinet floor while your hands support the front.
 - The appliance can be pushed fully into the cabinet. Take care to avoid fouling the mains lead.
 - Ensure the appliance is central and level.
 - Do not remove spacers fitted behind fixing holes.
 - When the appliance is fully housed screw the stability screws (supplied with the appliance) into the side of the cabinet taking care not to distort the side trims. It is advisable to turn each screw alternatively to avoid damaging the trims.
- Switch on the appliance then refer to the operating instructions.

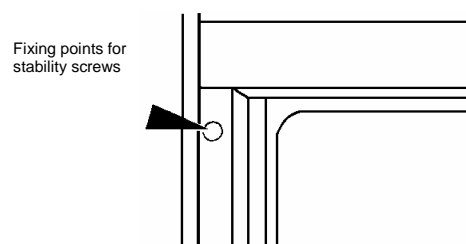

Recommended cabinet dimensions (mm)

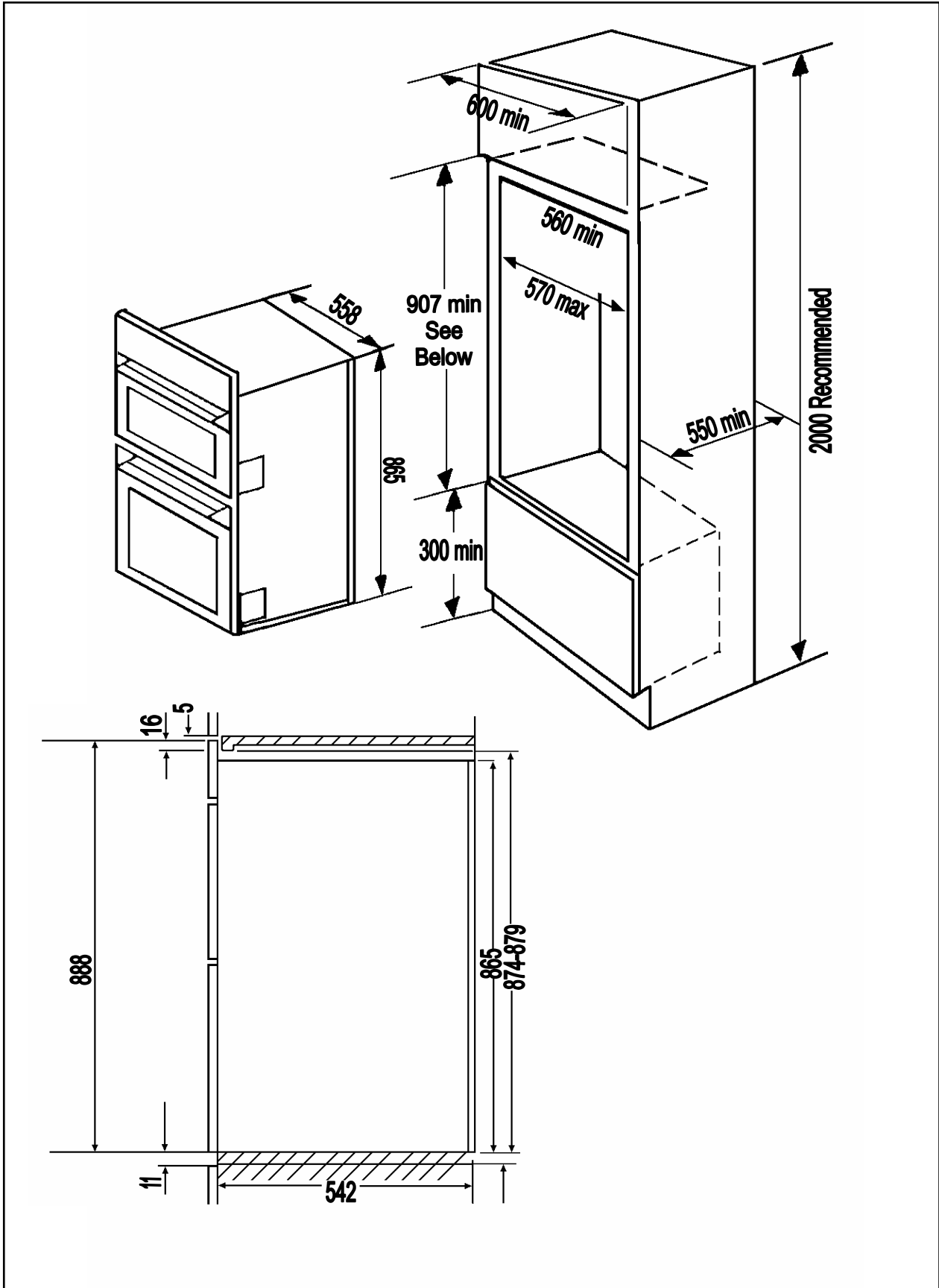

The control panel

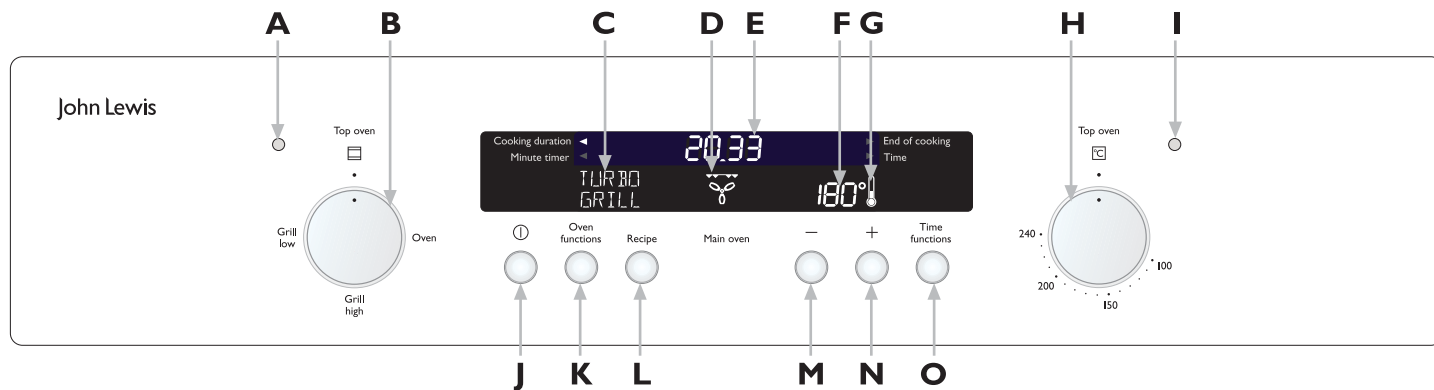

- A.** Top oven/Grill function neon
- B.** Top oven/Grill function selector
- C.** Cooking function indicator
- D.** Cooking function symbol
- E.** Main oven electronic timer
- F.** Main oven temperature setting
- G.** Main oven temperature symbol
- H.** Top oven/Grill temperature selector
- I.** Top oven/Grill temperature neon
- J.** On/Off button
- K.** Main oven function selector button
- L.** Recipe selector button
- M.** Decrease button
- N.** Increase button
- O.** Time function button

When the oven is first installed

Rating plate

This is usually situated on the front frame of the appliance and can be seen upon opening either the main or top oven door. Alternatively the rating plate may also be found on the back or top of some models (where applicable).

The appliance must be protected by a suitably rated fuse or circuit breaker.

The rating of the appliance is given on the rating plate.

Do not remove the rating plate from the appliance as this may invalidate the guarantee.

Preparing to use your appliance

Wipe over the base of the oven(s) with a soft cloth using hot soapy water. Wash the furniture before use.

We suggest that you run the oven(s) and grill for 10 – 15 minutes at maximum temperature, to burn off any residue from their surfaces. Accessible parts may become hotter than in normal use. Children should be kept away. During this period an odour may be emitted, it is therefore advisable to open a window for ventilation.

The cooling fan for the controls

The cooling fan comes on immediately when the grill is switched on and after a short time when the oven is in use. It runs on after the controls are switched off until the appliance has cooled. During the initial period the cooling fan may turn on and off, this is quite normal.

Warning

Always allow the cooling fan to cool the appliance down before switching off at the wall prior to carrying out any cleaning or maintenance work.

Control panel indicator neon(s)

The indicator neon will operate when the grill (where applicable) or oven(s) is switched on.

The indicator neon will glow. It may turn on and off during use to show that the setting is being maintained. If the neon does not operate as the instructions indicate the controls have been incorrectly set. Return all controls to zero and reset following the instructions for the required setting.

Condensation and steam

When food is heated it produces steam similar to a boiling kettle. The vents allow some of this steam to escape. However, always stand back from the appliance when opening the door(s) to allow any build up of steam or heat to release.

If the steam comes into contact with a cool surface on the outside of the appliance, e.g. a trim, it will condense and produce water droplets. This is quite normal and is not caused by a fault on the appliance.

To prevent discolouration, regularly wipe away condensation and foodstuff from surfaces.

For your safety wall coverings at the rear of the appliance should be securely fixed to the wall.

Cookware

Baking trays, dishes etc., should not be placed directly against the grid covering the fan at the back of the oven.

Do not use baking trays larger than 30cm x 35cm (12" x 14") as they will restrict the circulation of heat and may affect performance.

On/Off push button

The oven must be switched on before setting any cooking function or programme. When the on/off  button is pressed, the cavity symbol will show in the main oven electronic display.

To switch off the oven, you can press the on/off button  at any time. Any cooking function or programme will stop, the oven light will switch off and the main oven electronic display will show the time of day only.

Oven function control push buttons (main oven)

Press the main oven function selector button to allow you to select the cooking function. Each time you press this button a symbol will come on in the main oven electronic display, showing what cooking function has been chosen.

Setting the language

1. Switch the appliance on by pressing the on/off button.
2. Press the on/off button and the timer selector button simultaneously.
3. Using the increase and decrease buttons, select one of the languages displayed.
4. Press the on/off button and the timer selector button simultaneously to save the language selected.

Important

Remove all packaging both inside and outside the oven including the advertising labels and any protective film, before using the oven.

Setting the brightness of the display

The brightness of the oven display can be set so that it is easier to read if the oven has been installed in a high position.

1. Switch the appliance on by pressing the on/off button.
2. Press the on/off button and the timer selector button simultaneously.
3. Press the main oven function selector button once.
4. Set the brightness using the increase and decrease buttons.
5. Press the on/off button and the timer selector button simultaneously to save the selected brightness.

Recipe selector

1. Press the recipe selector button to select the required recipe.

(For further information see the Recipe function instructions)

Increase and decrease push buttons (main oven)

- Press the increase or decrease buttons to increase or decrease temperature or time settings.

Grill and oven furniture

- The following items of grill and oven furniture have been supplied with the appliance.

1 grill pan



2 grill

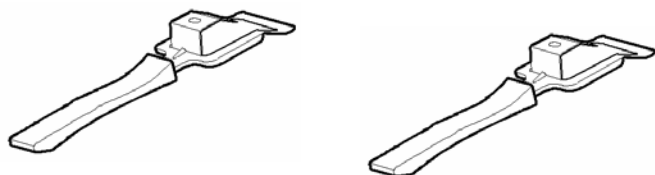

1 grill pan grid

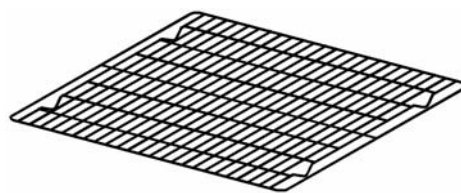

1 straight shelf

(For grilling and top oven cooking)

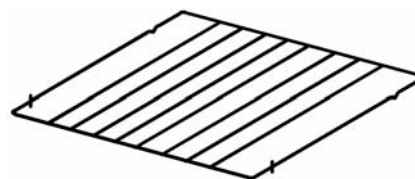

2 straight shelves

(For main oven cooking)

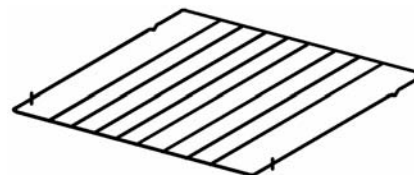
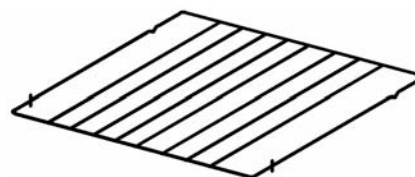

The timer

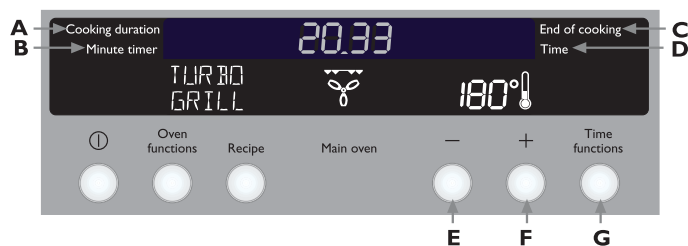

Key

- A. Cooking duration indicator neon
- B. Minute timer indicator neon
- C. End of cooking indicator neon
- D. Time indicator neon
- E. Decrease control
- F. Increase control
- G. Time functions

i Important

The time of day must be set before the main oven will operate manually.

To set the time of day

The oven has a 24 hour clock.

When the electricity supply is first switched on, the display will show 12:00 and the 'Time' indicator neon will flash.

To set the correct time press the increase control button and if necessary, the decrease control button until the correct time on the 24 hour clock is reached. The 'Time' indicator neon will flash for 5 seconds and then go out.

i Important

The increase and decrease control buttons operate slowly at first, and then more rapidly. They should be pressed separately.

To set the minute timer

The 'Minute timer' gives an audible reminder at the end of any period of cooking.

This cooking period may be up to 9 hrs 59 mins. It is not part of the automatic control.

To set, press the Time functions button until the 'Minute timer' indicator neon is illuminated and the display reads 0:00.

To set the required time duration, press the increase control until the display indicates the interval to be timed. If necessary press the decrease control to achieve the correct time interval.

i Important

This must be completed within 5 seconds of first pressing the Time functions button.

During the operation of the 'Minute timer', the remaining time period will be shown in the display.

The 'Minute timer' will sound intermittently for up to 2 minutes at the end of the timed period. The sound can be stopped by pressing any button.

To cancel the minute timer

If you change your mind and want to cancel the 'Minute timer', press the Time functions button until the 'Minute timer' indicator neon flashes then depress the decrease control until 0:00 shows in the display. The 'Minute timer' indicator neon will continue to flash for a few seconds and then return to the time of day.

To set the oven timer control

Only the main oven can be automatically timed.

When using the timer control for the very first time, it is advisable to let it operate while you are at home. The display can be checked to show that it is operating correctly and you will feel confident to leave a meal to cook automatically in the future.

To set the timer to switch on and off automatically

1. Ensure the electricity supply is switched on and that the correct time of day is displayed.
2. Place food in oven.
3. To set the length of cooking time. Press the Time functions button until the 'Cooking duration' indicator neon is illuminated.
4. Press the increase control until the required length of cooking time is displayed. If necessary press the decrease control until the correct time interval is achieved.
5. Release the buttons. The 'Cooking duration' indicator neon will be illuminated.

i Important

- Remember, this must be completed within 5 seconds of first pressing the Time functions button.
- 6. To set the 'End of cooking'. Press the Time functions button until the 'End of cooking' indicator neon flashes. Press the increase control button until the required stop time is displayed. If necessary press the decrease control until the required time interval is achieved.

7. Release the buttons. The time of day will be displayed after 5 seconds. The 'Cooking duration' and 'End of cooking' indicator neons will be illuminated.
8. Set the main oven control to the required temperature. The oven indicator neon should be off.

Important

When the automatic timed period starts, the main oven temperature symbol will flash until the oven has reached the desired temperature and then stop.

To set the timer to switch off only

1. Ensure the electricity supply is switched on and that the correct time of day is displayed.
2. Place food in the oven.
3. To set the length of cooking time, press the Time functions button until the 'Cooking duration' indicator neon is illuminated. Press the increase control until the required length of cooking time is displayed. Press the decrease control if necessary.
4. Release the buttons. The 'Cooking duration' indicator neon will illuminate and the time of day will be displayed after 5 seconds.
5. Set the oven temperature. The oven indicator neon should be on.
6. To check the 'End of cooking' during the cooking period, simply press the Time functions button once and the remaining time will be displayed.

To cancel an automatic programme

1. To cancel an automatic programme press the Time functions button until the 'Cooking duration' indicator neon flashes. Press the decrease control until the display reads 0:00.
2. Release the buttons. The 'Cooking duration' indicator neon will flash and after 5 seconds return to the time of day.
3. Turn off the oven controls.

To return the appliance to manual

At the end of a timed cooking period, the 'End of cooking' indicator neon will flash and an alarm will sound for up to 2 minutes.

1. To stop the sound, press any of the three buttons.
2. The display will return to the time of day.
3. Turn off the oven controls.

Things to note

In the event of an interruption of the electricity supply, the timer will reset it self to zero and all programming will be cancelled.

Automatic cooking

It is advisable to leave food in the oven for as short a time as possible before automatic cooking. Always ensure commercially prepared food is well within its use by date and that home prepared food is fresh and of good quality.

When cooking is complete, do not leave food to stand in the oven, but remove and cool it quickly if the food is not to be consumed immediately.

Always ensure food in the oven has been covered before cooking if it is not possible to remove food immediately after cooking.

Operation



The dual grill

Caution

Accessible parts may be hot when the grill is in use. Young children should be kept away.

The grill is a dual circuit grill which means that the full area of the grill can be used, or for economy purposes, the centre section only can be used when cooking smaller quantities of food.

Using the dual grill

- Pop out (by pressing) and turn the top oven/grill selector control  to the required setting.
- Pop out (by pressing) and turn the top oven/grill temperature control  to the required setting.

The grill settings are as follows: -

Grill low	Centre grill area.
Grill high	Full grill area.

Things to note

The grill door must be left open during grilling.

- The outer grill element may appear to glow slightly brighter than the inner element. This is quite normal.
- The cooling fan for the controls may operate after a time.
- The oven light will illuminate.
- Some smoke from fat splashes may be evident as the grill cleans itself.
- The top oven cannot be operated when the grill is in use.

To fit the grill pan handle

The grill pan is supplied with removable handles.

To attach the handles, place the wirework under the cut out in the pan so that the metal plate hooks over the top of the grill pan.



Warning

Ensure the handles are correctly located when lifting the grill pan.

- To remove the handles, lift away from the cut out on the grill pan.

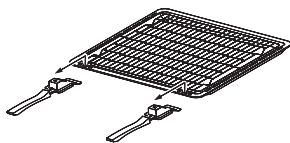

Place the grill pan on the shelf so that the pan is positioned centrally beneath the grill.

Warning

Protect your hands when removing the grill pan handles.



Always remove the grill pan handles during grilling. To check the progress of the food being grilled, the grill pan should be withdrawn on the shelf to attend to food during cooking.

The top oven

The top oven is the smaller of the two ovens. It is heated by elements in the top and bottom of the oven. It is designed for cooking smaller quantities of food. It gives especially good results if used to cook fruitcakes, sweets and savoury flans or quiche.

The top oven is ideal for use as a warming compartment. It can be used to warm dishes and keep food hot. Use the top oven when you want to warm plates. Use the lowest setting on the top oven temperature control.

Using the top oven

- Pop out (by pressing) and turn the top oven/grill selector control  to the required setting Oven.
- Pop out (by pressing) and turn the top oven/grill temperature control  to the required setting.

Things to note

- The top oven light will illuminate.
- The top oven/grill function neon and top oven/grill temperature neon will glow. The top oven/grill temperature neon will glow until the oven has reached the desired temperature and then go out. It will turn ON and OFF periodically during cooking showing that the temperature is being maintained.
- The cooling fan may operate after a time.
- The top oven works independently of the main oven and is not controlled by the Main Oven electronic display.

Warning

Do not place dishes, tins and trays directly on the oven base as it becomes very hot and damage will occur.

To fit the top oven shelf

The shelf should be fitted with the straight rods uppermost on the frame and the forms towards the back of the oven.

To remove a shelf slide the shelf towards you until the shelf stop is reached. Tilt shelf up at the front so that the stops clear the side supports. Lift shelf clear.



To install a shelf, reverse the above steps. Each shelf position has an upper and lower support wire, ensure the shelf is placed between these two support wires.

Warning











Do not place cookware and cooking pots with rough bases e.g. cast iron on the oven door as damage to the glass may occur.

The main oven

Your main oven is a multifunction oven with 10 convenient functions and can be set to the following modes of cooking. (See table below) For each of them, a pre-set temperature will be automatically selected.

The oven must be switched on before setting any cooking functions or programme. When the on/off button  is pressed the main oven cavity symbol  will shown in the electronic display window.

Multifunction oven setting guide

Symbol	Function	Description
 SINGLE GRILL	Main oven single grill	Centre grill area only.
 DUAL GRILL	Main oven dual grill	Full grill area.
 TURBO GRILLING	Turbo grilling	This function offers an alternative method of cooking food items, normally associated with conventional grilling. The grill element and the oven fan operate together, circulating hot air around the food. Select a maximum temperature of 220°C.
 TOP & BOTTOM	Main oven conventional cooking	The heat comes from both the top and bottom element, ensuring even heating inside the oven.
 FAN COOKING	Main oven fan cooking	This setting allows you to roast or roast and bake simultaneously using any shelf, without flavour transference.
 PIZZA SETTING	Pizza	This setting can be used for foods such as pizzas, quiches or pies, where base browning and crispness are required. The lower element operates in conjunction with the fan oven.
 BOTTOM HEAT	Main oven base heat finishing	The heat comes from the bottom of the oven only, to allow you to finish your dishes.
 TOP HEAT	Main oven top heat finishing	The heat comes from the top of the oven only, to allow you to finish your dishes.
 KEEP WARM	Keep warm	This setting allows you to warm plates or keep warm pre-cooked dishes prior to serving.
 DEFOST	Defrost feature	Defrosts most foods faster than some conventional methods. It is particularly suitable for delicate frozen foods which are to be served cold.

To fit the main oven shelves

The shelf should be fitted with the straight rods uppermost on the frame and the forms towards the back of the oven.

To remove a shelf slide the shelf towards you until the shelf stop is reached. Tilt shelf up at the front so that the stops clear the side supports. Lift shelf clear.

To install a shelf, reverse the above steps. Each shelf position has an upper and lower support wire, ensure the shelf is placed between these two support wires.



Main oven grill

The grill is a dual circuit grill, which means that the full area of the grill can be used, or for economy purposes, the centre section only can be used when cooking smaller quantities of food.

Caution

Accessible parts may be hot when the grill is in use. Young children should be kept away.

Using the single grill

- Press the main oven function selector button  until the main oven single grill symbol  is displayed.
- Wait 5 seconds until your choice is confirmed. The grill will be pre-set to 250°C.

Using the dual grill

- Press the main oven function selector button  until the main oven dual grill symbol  is displayed.

- Wait 5 seconds until your choice is confirmed. The grill will be pre-set to 250°C.

Things to note

- The main oven temperature symbol  will flash until the grill has reached the desired temperature and then stop.
- When the required temperature is reached an audible signal will sound.
- The cooling fan for the controls will operate in conjunction with the grill. It may run on after the controls are switched off, until the appliance has cooled.
- Some smoke from fat splashes may be evident as the grill cleans itself.
- The main oven light will come on.
- To ensure optimal cooking performance the elements have been carefully designed, so that only the inner element glows red. The outer element is hot, but will remain dark in colour. This gives you the best possible cooking results.

Turbo grilling

Turbo grilling in the main oven offers an alternative method of cooking food items normally associated with conventional grilling.

The grill element and the oven fan operate together, circulating hot air around the food. The need to check and turn food is reduced. Turbo grill fan assisted grilling helps to minimise cooking smells in the kitchen and allows you to grill with the oven door closed.

With the exception of toast and rare steaks you can Turbo grill all the foods you would normally cook under a conventional grill.

The lower part of the oven can be used to cook accompaniments at the same time, e.g. tomatoes and mushrooms with a mixed grill or breakfast.





Dishes prepared in advance such as shepherd's pie, lasagne and au gratins can be heated through and browned on the top using the Turbo grill function.

Using turbo grilling



Warning

Always turbo grill with the oven door closed and with the grill pan handle removed.

- Press the main oven function selector button  until the turbo grilling symbol  is displayed.
- Wait 5 seconds until your choice is confirmed. The grill will be pre-set to 180°C.
- The temperature can be adjusted by pressing either the increase  or decrease  button.





Things to note

- The main oven temperature symbol  will flash until the grill has reached the desired temperature and then stop.
- When the required temperature is reached an audible signal will sound.
- The oven fan and internal oven light will come on.
- The cooling fan for the controls will operate in conjunction with the grill. It may run on after the controls are switched off, until the appliance has cooled.

Main oven conventional cooking

This main oven function uses the top and lower elements to give single level cooking. This is particularly suitable for dishes, which require extra base browning such as pizzas, quiches and flans. Gratins, lasagne and hotpots, which require extra top browning, also cook well in the conventional oven. This form of cooking gives you the opportunity to cook without the fan oven in operation.

Using conventional cooking

- Press the main oven function selector button  until the main oven conventional cooking symbol  is displayed.
- Wait 5 seconds until your choice is confirmed. The oven will be pre-set to 200°C.
- The temperature can be adjusted by pressing either the increase  or decrease  button.

Things to note

- The main oven temperature symbol  will flash until the oven has reached the desired temperature and then stop.
- When the required temperature is reached an audible signal will sound.
- The internal oven light will come on.
- The cooling fan for the controls operates after a time. It may run on after the controls are switched off, until the appliance has cooled.



Warning

Do not place dishes, tins and trays directly onto the oven base as it becomes very hot and damage will occur.

Main oven fan cooking

The fan oven is particularly suitable for cooking larger quantities of food.

The advantages of fan oven cooking are:

Preheating

The fan oven quickly reaches its temperature, so it is not usually necessary to preheat the oven. Without preheating however, you may need to add an extra 5 – 10 minutes on the recommended cooking times. For recipes needing high temperatures, e.g. bread, pastries, scones, soufflés etc., best results are achieved if the oven is preheated first. For best results when cooking frozen or cooked chilled ready meals always preheat the oven first.

Cooking temperatures

Fan oven cooking generally requires lower temperatures than conventional cooking. Follow the temperatures recommended in the cooking chart. As a guide reduce temperatures by about 20°C – 25°C for your own recipes, using a conventional oven.

Batch baking

The fan oven cooks evenly on both shelf levels, especially useful when batch baking.

Using the fan oven

- Press the main oven function selector button ^{Oven functions} until the fan oven symbol ^{FAN COOKING} (🌀) is displayed.
- Wait 5 seconds until your choice is confirmed. The oven will be pre-set to 180°C.
- The temperature can be adjusted by pressing either the increase + or decrease – button.

Things to note

- The main oven temperature symbol ↓ will flash until the oven has reached the desired temperature and then stop.
- When the required temperature is reached an audible signal will sound.
- The oven fan will operate continually during cooking.
- The internal oven light will come on.
- The cooling fan for the controls operates after a time. It may run on after the controls are switched off, until the appliance has cooled.

Warning

Do not place cookware and cooking pots with rough bases e.g. cast iron on the oven door as damage to the glass may occur.

Pizza

This setting can be used for foods such as pizza where base browning and crispness are required.

The lower element operates in conjunction with the oven fan.

Using pizza

- Press the main oven function selector button ^{Oven functions} until the pizza symbol ^{PIZZA SETTING} (🍕) is displayed.
- Wait 5 seconds until your choice is confirmed. The oven will be pre-set to 200°C.
- The temperature can be adjusted by pressing either the increase + or decrease – button.

Things to note

- The main oven temperature symbol ↓ will flash until the oven has reached the desired temperature and then stop.
- When the required temperature is reached an audible signal will sound.
- The internal oven light will come on.
- The cooling fan for the controls operates after a time. It may run on after the controls are switched off, until the appliance has cooled.

Warning

Do not place dishes, tins and trays directly onto the oven base as it becomes very hot and damage will occur.

Top heat / Base heat finishing functions

These functions should not be used for the entire cooking time. They are intended as support functions only.

Using base heat finishing

This function can be used to finish off dishes that may require extra base heat or where base browning and crispness are required by pizzas or pies.

Some pizzas should be cooked directly on the oven shelf. To prevent soiling the oven base, place a baking tray in one of the lower positions.

- Press the main oven function selector button ^{Oven functions} until the main oven base heat symbol ^{BOTTOM HEAT} (🔥) is displayed.
- Wait 5 seconds until your choice is confirmed. The oven will be pre-set to 120°C.
- The temperature can be adjusted by pressing either the increase + or decrease – button.

Using top heat finishing

This function can be used to finish off dishes that may require extra Top Heat.

This function is particularly useful for items such as cauliflower cheese or au gratin dishes, which may require top browning before serving.

- Press the main oven function selector button ^{Oven functions} until the main oven top heat symbol  is displayed.
- Wait 5 seconds until your choice is confirmed. The oven will be pre-set to 120°C.
- The temperature can be adjusted by pressing either the increase + or decrease - button.

Things to note

- The main oven temperature symbol  will flash until the oven has reached the desired temperature and then stop.
- When the required temperature is reached an audible signal will sound.
- The internal oven light will come on.
- The cooling fan for the controls operates after a time. It may run on after the controls are switched off, until the appliance has cooled.



Warning

Do not place dishes, tins and trays directly onto the oven base as it becomes very hot and damage will occur.

Keep warm

This setting allows you to warm plates or keep warm pre-cooked dishes prior to serving.

- Press the main oven function selector button ^{Oven functions} until the keep warm symbol  is displayed.
- Wait 5 seconds until your choice is confirmed. The oven will be pre-set to 80°C.

Things to note

- The main oven temperature symbol  will flash until the oven has reached the desired temperature and then stop.
- When the required temperature is reached an audible signal will sound.
- The internal oven light will come on.

Defrost feature

This main oven function defrosts most foods faster than more conventional methods. It is particularly suitable for delicate frozen foods, which are to be served cold e.g. cream filled gateaux, cakes covered with icings or frostings, cheesecakes, biscuits, scones, etc.

Using the defrost feature

- Press the main oven function selector button ^{Oven functions} until the defrost symbol  is displayed.
- Wait 5 seconds until your choice is confirmed. The oven will be pre-set to 30°C.

Things to note

- The main oven fan and main oven light will come on.
- An audible signal will sound when selecting 'Defrost'.

Recipe function

Your main oven is pre-programmed with 10 convenient recipe settings. By following the recipes provided in this manual you will easily prepare and cook these recipes with the best results. (See table below) For each of them, a pre-set temperature will be automatically selected, you will be advised which shelf position to use and you will be informed of the cook time and the time at which your recipe will be complete.

The oven must be switched on before setting any of the recipe settings. When the on/off button (Ⓛ) is pressed the main oven cavity symbol (☐) will be shown in the electronic display window.

Recipe setting guide

Recipe	Description
Sponge cake	Press the recipe button once
White bread	Press the recipe button twice
Fillet of fish	Press the recipe button three times
Pizza	Press the recipe button four times
Potato gratin	Press the recipe button five times
Quiche Lorraine	Press the recipe button six times
Lasagne	Press the recipe button seven times
Chicken	Press the recipe button eight times
Leg of lamb	Press the recipe button nine times
Joint of pork	Press the recipe button ten times

Using the recipe function

- Press the recipe function selector button until the recipe you require appears in the display window.
- The function indicator shows the symbol for the corresponding oven function and the recommended shelf position.

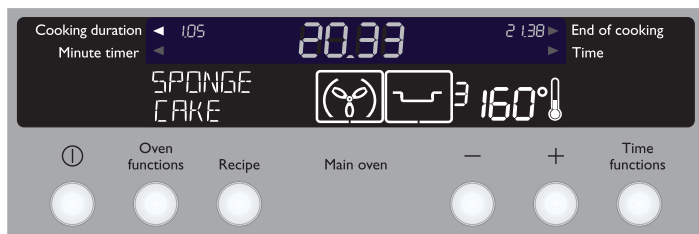

- The temperature indicator shows the selected temperature.
- The time indicators show the cooking time and end of cooking time.
- Place the food into the oven.
- After 3 seconds the oven comes on. At the end of the cooking time a signal will sound.
- To stop the programme before the end of the cooking time press the recipe button and scroll through the recipes until no recipes appear in the display.
- To switch off the oven, you can press the on/off button at any time. Any cooking function or programme will stop, the oven light will switch off and the main oven electronic display will show the time of day only.

Things to note

- The main oven temperature symbol (Ⓛ) will flash until the oven has reached the desired temperature and then stop.
- When the required temperature is reached an audible signal will sound.
- The internal oven light will come on.

Recipes

Sponge Cake

Ingredients

175g Block Margarine
175g Castor Sugar
5ml Vanilla Essence
3 Large Eggs beaten
125g Plain Flour
125g Self Raising Flour
30ml Milk

Method

1. Cream block margarine and castor sugar together until the mixture is light and fluffy. Add the vanilla essence and eggs a little at a time, beating well after each addition of egg.
2. Sift in the flour and fold in slowly. Add milk gradually until a dropping consistency is reached.
3. Transfer the mixture into a greased 18cm round cake tin, which is 7 cm deep. Level the surface. Place in the oven and set to Sponge Cake pre-set function, ensuring the correct shelf position has been used.
4. Bake until the full pre-set cook time has elapsed.
5. A signal will sound 10 minutes before the end of cooking to remind you that the cooking programme will finish shortly.
6. Turn out the cake onto a cooling rack.

Variations

For Lemon Cake add the rind of one lemon very finely chopped towards the end of step 1 and replace the 30ml of milk with 30ml of lemon juice in step 2.

For Sultana Cake add 175gm sultanas with the flour in step 2.

For Apricot Cake add 75gm apricot jam towards the end of step 1 and 75gm of chopped dried apricots with the flour in step 2.

White Bread (Makes two 1lb Loaves)

Ingredients

750g Strong Bread Flour
25g Margarine
7g Dried Yeast
10ml Salt
400 - 450ml Warm Water not over 37°C

Method

1. Rub flour and margarine together until a very fine breadcrumb consistency is formed.
2. Add the yeast and salt and stir in well. Slowly add the lukewarm water and bring mixture together.
3. Place dough on a floured work surface and knead together until a smooth dough is formed. Cover and leave in a warm area until the dough has doubled in volume.
4. Knead thoroughly again, and separate the dough into 2 equal portions.
5. Grease two, 1 lb. loaf tins and place the dough in them. Cover and leave in a warm area to rise again.
6. Carefully uncover, place in oven and set to White Bread pre-set function, ensuring the correct shelf position has been used.
7. Bake until the full pre-set cook time has elapsed.
8. A signal will sound 10 minutes before the end of cooking to remind you that the cooking programme will finish shortly.
9. Turn out the bread onto a cooling rack.

Fillet of Fish

Ingredients

600 – 700g Fillet of Fish e.g. Salmon, Trout
1 Lemon
Salt and Black Pepper (to season)
150g Grated Cheddar Cheese
250ml Single Cream
50g Breadcrumbs
10g Chopped Parsley

Method

1. Sprinkle the juice of the lemon onto the fish and leave to soak in for a few minutes. Wipe off any excess juice with a kitchen towel. Season the fish on both sides and place in a flameproof dish.
2. Mix the cheese, cream, breadcrumbs and chopped parsley together and spread over the top of the fish to form a surface layer.
3. Place in oven and set to Fillet of Fish pre-set function, ensuring the correct shelf position has been used.
4. Bake until the full pre-set cook time has elapsed.
5. A signal will sound 10 minutes before the end of cooking to remind you that the cooking programme will finish shortly.

Pizza

Ingredients

Dough
7g Dried Yeast
300g Plain Flour
2.5ml Salt
185ml Warm Water not over 37°C

Topping

100g Passata or Chopped Tomato
100g Salami
170g Mushrooms sliced
1/2 Onion finely sliced
150g Emmenthal Cheese (grated) or 300g Mozzarella (sliced)
3 – 5g of Oregano/Basil or a mixture of both to suit taste.

Method

1. Add the yeast, flour and salt to a bowl and mix well. Slowly add the warm water and bring the mixture together.
2. Place dough on a floured work surface and knead until smooth dough is formed, cover and leave in a warm area until the dough has doubled in volume.
3. Knead thoroughly again and roll/manipulate the dough into a thin layer and lay out over a 30 cm square baking tray.
4. Layer the topping on top of the dough in the order shown above.
5. Leave to rise again for approximately 20 minutes.
6. Place in oven and set to Pizza pre-set function, ensuring the correct shelf position has been used
7. Bake until the full pre-set cook time has elapsed.
8. A signal will sound 10 minutes before the end of cooking to remind you that the cooking programme will finish shortly.

Potato Gratin

Ingredients

750g Potatoes
5ml Salt and 5ml Black Pepper
2 Cloves of Garlic
25gm Butter
300g Greyere or Emmenthal cheese (grated)
3 Large Eggs
350ml Milk
5ml Dried Thyme

Method

1. Peel and cut the potatoes into thin slices, dry them thoroughly and sprinkle with salt and black pepper.
2. Rub a flameproof roasting dish (3–4 pints) with a clove of garlic and grease the dish with half of the butter.
3. Layout half the potato slices in the dish and sprinkle over half of the grated cheese. Place the remaining potato slices on top of the first layer and place the remaining cheese on top.
4. Crush the other clove of garlic and lightly beat together with the eggs, milk and thyme. Pour this sauce over the potatoes.
5. Cut the rest of the butter into small knobs and place on top of the potatoes.
6. Place in oven and set to Potato Gratin preset function, ensuring the correct shelf position has been used.
7. Bake until the full pre-set cook time has elapsed.
8. A signal will sound 10 minutes before the end of cooking to remind you that the cooking programme will finish shortly.

Quiche Lorraine

Ingredients

200g Plain White Flour
Pinch of Salt
100g Butter diced
3 Large Eggs
15ml Water cold
100g Streaky Bacon
50g Onion finely diced
75g Cheddar Cheese grated
Black Pepper to taste

Method

1. To make the pastry, rub the flour, salt and butter together until a breadcrumb consistency is formed. Gradually add one slightly beaten egg and the water, blend until the mixture comes together and forms a ball. Place the pastry onto a floured surface and knead until smooth. Wrap the pastry in cling film and refrigerate for 30 minutes.
2. Roll out the pastry on a floured surface and line a round 23cm diameter and 4cm deep quiche / flan tin. Return the pastry and tin to the refrigerator for a further 15 minutes.
3. Prick the pastry base with a fork, line the inside of the case with greaseproof paper, and fill with baking beans (raw rice could also be used if no baking beans are available). Place the pastry case in oven and set to Quiche Lorraine pre-set function, ensuring the correct shelf position has been used. Blind bake until 25mins are left on the pre-set cook time.
4. Whilst blind baking the pastry case, cut the streaky bacon into small pieces and lightly fry, add the onions towards the end to slightly soften. Cool the bacon and onions and remove any excess fat using kitchen roll. Beat together the eggs and milk.
5. Quickly remove the blind baked Quiche base case from the oven with 25 minutes left on the cook time display. Remove the baking beans and the greaseproof paper. Place half the cheese in the quiche base and cover with the cooked bacon and onion.
6. Pour the beaten eggs and milk mixture over the eggs and bacon being careful not to overfill the pastry base. Sprinkle the remaining cheese on top of the quiche; return the Quiche to the oven.
7. Bake until the remaining cook time has elapsed.
8. A signal will sound 10 minutes before the end of cooking to remind you that the cooking programme will finish shortly.

Lasagne

Ingredients

225g (12-15 sheets) of dried "No need to pre cook"
Lasagne sheets

Bolognese Sauce

1 Onion large, peeled and finely chopped
1 Carrot, peeled and finely chopped
1 Celery Stick, peeled and finely chopped
1 Garlic Clove, peeled and finely chopped
100g of Button Mushrooms chopped
450g Minced Beef
250ml Red Wine
400g Chopped Tomatoes or Passata
15ml Tomato Puree
10ml Dried Oregano
Salt and Black Pepper, to taste
50g Parmesan Cheese, grated
75g Cheddar Cheese, grated

Béchamel Sauce

500ml of Milk
2 Onion slices large
10 Peppercorns
2 Bay Leaves
Pinch Salt and Black Pepper
Pinch Ground Nutmeg
50g Butter
50g Plain Flour

Method

1. Add onion, carrot, celery, garlic and mushrooms into saucepan, gently fry for 2-3 minutes. Add the minced beef and stir until browned.
2. Add the wine, chopped tomatoes, tomato puree, oregano, and seasoning. Place lid on the pan and simmer for 45- 60 minutes until meat is tender and sauce has reduced down.
3. To make the béchamel sauce, pour the milk into a saucepan and add the onions, peppercorns, bay leaves, salt, black pepper and nutmeg. Bring the milk almost to the boil and take off the heat. Place lid on pan and leave the milk to infuse the flavours for 20 minutes then strain into a jug.
4. To make the roux, melt the butter in a saucepan, gradually stir in the flour and cook for one minute whilst continuously stirring.
5. Take the pan off the heat and very gradually add in the milk stirring constantly. Return to the heat, add the grated cheddar cheese and stir thoroughly until the sauce is smooth and thickened.
6. Place one third of the bolognese sauce into the base of a greased 2.3 litre oven proof dish. Cover with a layer of pasta then a layer of béchamel sauce. Repeat until the top surface layer is completely covered in béchamel sauce. Sprinkle the Parmesan cheese over the surface.
7. Place in oven and set to Lasagne pre-set function, ensuring the correct shelf position has been used.
8. Bake until the full pre-set cook time has elapsed.
9. A signal will sound 10 minutes before the end of cooking to remind you that the cooking programme will finish shortly.

Chicken

Ingredients

2 Chickens (1200g each)
15ml Olive Oil
Pinch Salt and Black pepper

Method

1. Take out the innards of the bird (if applicable), rinse the cavity and dry thoroughly. Make a small incision under each leg and wing to allow any excess liquid/juices to flow into the roasting tin.
2. Rub the olive oil, salt and black pepper into the skin of the chickens.
3. Place the birds side by side on the oven shelf with a tray / roasting tin placed underneath on the shelf below.
4. Place in oven and set to Chicken pre-set function, ensuring the correct shelf position has been used.
5. Bake until the full pre-set cook time has elapsed.
6. A signal will sound 10 minutes before the end of cooking to remind you that the cooking programme will finish shortly. NOTE During the cook time, lift up the birds to allow any excess liquid/juices, to flow into the roasting tin through the neck cavity. Always ensure the chicken is piping hot before removing from the oven.

Leg of Lamb

Ingredients

1.5 – 2.0 kg Leg of Lamb
2 Cloves of Garlic
10ml Salt
2 Onions
1 Carrot
1 Stick Celery
25g Butter
150ml Water
5ml Black Pepper
5ml Thyme
2 Bay Leaves
1 large pinch of All Spice
350ml Lamb Stock warmed
1 Pepper
5ml Parsley
15ml Cornflour

Method

1. Peel the cloves of garlic and crush into a smooth paste using the 10ml of salt. Rub the mixture all over the lamb.
2. Peel the onions, carrot and celery. Chop coarsely.
3. Heat the butter on the hob in a large flameproof roasting dish and carefully sear all sides of the lamb. Remove the lamb from the dish. Add the onions, carrot, and celery and cook for a short time until they begin to soften.
4. Deglaze the vegetables with 150ml of water. Add the black pepper, thyme, bay leaves, all spice and stir. Return the lamb to the roasting dish.

5. Place in oven and set to Leg of Lamb pre-set function, ensuring the correct shelf position has been used.
6. Halfway through the cook time, turn the meat over and pour the warmed stock over it.
7. Cook until the full pre-set cook time has elapsed.
8. Turn several times during cooking and baste often with the juices. Dice the pepper and add around 10 minutes before the end of the cook time.
9. A signal will sound 10 minutes before the end of cooking to remind you that the cooking programme will finish shortly.
10. Once the cook time has elapsed take the meat out of the pan, wrap in aluminium foil, and leave to stand in the oven (switched off) for around 10 minutes. Warm a serving dish.
11. Meanwhile heat up the gravy in the roasting tin, and bring to the boil.
12. Mix the cornflour with a little hot water, gradually add to the gravy stirring continuously, add the chopped parsley and season to taste.
13. Unwrap the lamb, separate the bone, cut the meat into slices and arrange on serving dish. Add the gravy.

Joint of Pork

Ingredients

1 kg – 1.5kg joint of Pork
5ml Salt
5ml Black Pepper
2 Onions
2 Carrots
1 Clove of Garlic
500ml Pork Stock warmed
15ml Cornflour

Method

1. Sprinkle the meat with salt and black pepper. Peel the onions, carrots and garlic and chop coarsely. Place the meat together with the vegetables in a roasting dish.
2. Place in oven and set to the Joint of Pork pre-set function, ensuring the correct shelf position has been used.
3. Halfway through the cooking time, turn the meat over and pour the warmed stock over it.
4. Cook until the full pre-set cook time as elapsed.
5. Turn several times during cooking and baste often with the juices.
6. Once the cook time has elapsed take the meat out of the pan, wrap in aluminium foil and leave to stand in the oven (switched off) for around 10 minutes. Warm a serving dish.
7. Meanwhile heat up the gravy in the roasting tin and bring to the boil.
8. Mix the cornflour with a little hot water; gradually add to the gravy stirring continuously, and season to taste.
9. Unwrap the pork, cut the meat into slices and arrange on serving dish. Add the gravy.
10. A signal will sound 10 minutes before the end of cooking to remind you that the cooking programme will finish shortly.

Safety and energy saving functions

Child safety lock

To avoid children switching on the main oven when the appliance is switched off, it is possible to lock the oven controls in the main oven only.

The main oven child security lock.

The oven cannot be used from the moment the child security lock has been switched on.

Switching on the child security lock.

- No oven function must be selected.
- Press the recipe button and the decrease button simultaneously until 'CHILD SAFETY' appears in the display.
- The child security lock is now in operation.

Switching off the child security lock.

- Press the recipe button and the decrease button simultaneously until 'CHILD SAFETY' disappears from the display.
- The child safety lock has now been switched off and the oven is ready for use.
- The Main Oven can still be turned off by pressing the on/off button.

Locking use of the buttons.

To protect all set oven functions from being inadvertently altered.

Switching on the button lock function.

- Switch the appliance on (if it is off) by pressing the on/off button ①.
- Select oven function.
- Press the recipe button and the decrease button simultaneously until 'LOCK' appears in the display.
- The button lock function is now in operation.

Switching off the button lock function.

- Press the recipe button and the decrease button simultaneously for approx. 2 seconds.
- The lock on the use of buttons will be automatically lifted when the appliance is switched off.
- The Main Oven can still be turned off by pressing the on/off button.

Energy saving safety cut out function

If no changes are made to the oven settings, the oven will switch off automatically, according to the following table.

If temperature setting is:	The oven will switch off:
250°C or more	After 1 ½ hours
From 120°C up to 250°C	After 5 hours
Less than 120°C	After 12 hours

Grilling chart

FOOD	TOP OVEN	MAIN OVEN
	GRILL TIME (mins in total)	GRILL TIME (mins in total)
Bacon Rashers	5 – 6	5 – 6
Beef Burgers	10 – 15	10 – 15
Chicken Joints	30 – 40	30 – 40
Lamb Chops	15 – 20	15 – 20
Pork Chops	20 – 30	20 – 30
Whole Trout/Mackerel	15 – 25	15 – 25
Plaice/Cod Fillets	10 – 15	10
Kebabs	20 – 30	20 – 30
Kidneys – Lamb/Pig	8 – 12	8 – 12
Liver – Lamb/Pig	10 – 20	10 – 20
Sausages	20 – 30	20 – 30
Steak – Rare	6 – 12	6 – 12
Steak – Medium	12 – 16	12 – 16
Steak – Well Done	14 – 20	14 – 20
Toasted Sandwiches	3 – 4	3 – 4

The times quoted above are given as a guide and should be adjusted to suit personal taste.

Adjust the grill setting and the grill pan grid to suite different thicknesses of food.

Turbo grilling chart

FOOD	SHELF	TEMP (°C)	GRILL TIME (mins in total)
Bacon Rashers	4	200	8 – 12
Beef Burgers	4	190	10 – 15
Chicken Joints	4	160	35 – 45
Lamb Chops	4	170	20 – 25
Pork Chops	4	170	25 – 35
Whole Trout/Mackerel	3	170	10 – 20
Plaice/Cod Fillets	3	170	10 – 15
Kebabs	4	170	20 – 30
Kidneys – Lamb/Pig	4	180	10 – 15
Liver – Lamb/Pig	4	180	30 – 35
Sausages	4	190	10 – 15
Steak – Medium	4	220	8 – 10 each side
Steak – Well Done	4	220	10 – 12 each side
Heating through and browning e.g. Au-gratin, Lasagne, Shepherds pie.	3	170	20 – 30 depending on size

Shelf positions are counted from the bottom of the oven.

The times quoted above are given as a guide and should be adjusted to suit personal taste.

Top oven cooking chart

The oven temperatures are intended as a guide only. It may be necessary to increase or decrease the temperatures by 10°C to suit individual preferences and requirements.

FOOD	TOP OVEN		
	POS	COOKING TEMP °C	APPROX COOK TIME (m)
Biscuits	2	170 - 190	10 - 20
Bread	1	200 - 220	25 - 30
Bread rolls/buns	1	200 - 220	15 - 20
Small / Queen Cakes	2	170 - 180	18 - 25
Sponges	2	160 - 170	18 - 20
Victoria Sandwich	2	160 - 170	18 - 25
Madeira Cake	1	140 - 150	1¼ - 1½h
Rich Fruit Cake	1	140 - 150	2¼ - 2½h
Christmas Cake	1	130 - 140	3 - 4½h
Gingerbread	1	140 - 150	1¼ - 1½h
Flapjack	1	170 - 180	25 - 30
Shortbread	1	140 - 150	45 - 65
Fruit Pies, Crumbles	1	190 - 200	40 - 50
Milk Puddings	1	140 - 150	1½ - 2h
Scones	2	220 - 230	8 - 12
Choux Pastry	1	180 - 190	30 - 35
Éclairs / Profiteroles	1	170 - 180	20 - 30
Flaky Pastry	1	210 - 220	25 - 40
Mince Pies	1	190 - 200	15 - 20
Pasta Lasagne etc.	1	170 - 180	40 - 45
Meat Pies	1	190 - 210	25 - 35
Quiche, Tarts, Flans	1	180 - 200	25 - 45
Shepherd's Pie	1	190 - 200	30 - 40
Soufflés	1	170 - 180	20 - 30
Fish	1	170 - 190	20 - 30
Fish Pie	1	190 - 200	20 - 25
Beef Casserole	1	140 - 160	2½ - 3h
Lamb Casserole	1	140 - 160	2½ - 3h
Convenience Foods	Follow manufacturer's instructions		
Baked Potatoes	1	180 - 190	1 - 1½h
Roast Potatoes	1	180 - 190	1 - 1½h
Large Yorkshire Puddings:	1	200 - 210	25 - 40
Individual Yorkshire Puddings	1	200 - 210	15 - 25

Shelf positions are counted from the bottom of the oven.

Main oven cooking chart

The oven temperatures are intended as a guide only. It may be necessary to increase or decrease the temperatures by 10°C to suit individual preferences and requirements.

FOOD	FAN OVEN	CONVENTIONAL OVEN		APPROX COOK TIME (m)
	COOKING TEMP °C	POS	COOKING TEMP °C	
Biscuits	180 - 190	3	180 - 190	10 - 20
Bread	200 - 220	3	210 - 220	25 - 30
Bread rolls/buns	200 - 220	3	210 - 220	15 - 20
Small / Queen Cakes	160 - 170	3	170 - 180	18 - 25
Sponges	160 - 170	3	170 - 180	20 - 30
Victoria Sandwich	160 - 170	3	170 - 180	18 - 25
Madeira Cake	140 - 150	3	160 - 170	1¼ - 1½h
Rich Fruit Cake	130 - 140	3	150 - 160	2¼ - 2½h
Christmas Cake	130 - 140	2	130 - 140	3 - 4½h
Gingerbread	140 - 150	3	140 - 150	1¼ - 1½h
Meringues	80 - 100	2	90 - 100	2½ - 3h
Flapjack	170 - 180	3	170 - 180	25 - 30
Shortbread	130 - 140	3	140 - 150	45 - 65
Fruit Pies, Crumbles	190 - 200	3	190 - 200	40 - 60
Milk Puddings	130 - 140	3	130 - 140	1½ - 2h
Scones	210 - 220	4	220 - 230	8 - 12
Choux Pastry	190 - 200	3	200 - 220	30 - 35
Éclairs / Profiteroles	170 - 180	3	170 - 180	20 - 30
Flaky Pastry	210 - 220	3	210 - 220	25 - 40
Mince Pies	190 - 200	3	190 - 200	15 - 20
Pasta Lasagne etc.	190 - 200	3	170 - 180	40 - 45
Meat Pies	190 - 210	3	190 - 210	25 - 35
Quiche, Tarts, Flans	170 - 180	3	190 - 200	25 - 45
Shepherd's Pie	190 - 200	3	190 - 200	30 - 40
Soufflés	170 - 180	3	170 - 180	20 - 30
Fish	170 - 190	3	170 - 190	20 - 30
Fish Pie	190 - 200	3	190 - 200	20 - 25
Beef Casserole	140 - 160	3	150 - 180	2½ - 3h
Lamb Casserole	140 - 160	3	150 - 180	2½ - 3h
Convenience Foods	Follow manufacturer's instructions			
Baked Potatoes	180 - 190	3	180 - 190	1 - 1½h
Roast Potatoes	180 - 190	4	180 - 190	1 - 1½h
Large Yorkshire Puddings:	210 - 220	4	210 - 220	25 - 40
Individual Yorkshire Puddings	200 - 210	4	200 - 210	15 - 25

Shelf positions are counted from the bottom of the oven.

Fan oven shelf positions are not critical but ensure that they are evenly spaced when more than one is used.

Roasting chart

MEAT	TEMPERATURE	COOKING TIME
Beef/ Beef boned	160-180°C	20-35 minutes per ½kg (1lb) and 20-35 minutes over
Mutton/Lamb	160-180°C	25-35 minutes per ½kg (1lb) and 25-35 minutes over
Pork/Veal/Ham	160-180°C	30-40 minutes per ½kg (1lb) and 30-40 minutes over
Chicken	160-180°C	15-20 minutes per ½kg (1lb) and 20 minutes over
Turkey/Goose	160-180°C	15-20 minutes per ½kg (1lb) up to 3½kg (7lb) then 10 minutes per ½kg (1lb) over 3½kg (7lb)
Duck	160-180°C	25-35 minutes per ½kg (1lb) and 25-30 minutes over
Pheasant	160-180°C	35-40 minutes per ½kg (1lb) and 35-40 minutes over
Rabbit	160-180°C	20 minutes per ½kg (1lb) and 20 minutes over

INTERNAL TEMPERATURES –

Rare: 50-60°C; Medium: 60-70°C; Well done: 70-80°C

The roasting temperatures and times given in the chart should be adequate for most joints, but slight adjustments may be required to allow for personal requirements and the shape and texture of the meat. However, lower temperatures and longer cooking times are recommended for less tender cuts or larger joints.

Wrap joints in foil if preferred, for extra browning uncover for the last 20 – 30 min. cooking time.

Hints and tips

Hints and tips when using the grill (Top and Main oven)

- In order to become familiar with the performance of the dual grill it is advisable to check food regularly when grilling.
- Most foods should be placed on the grid in the grill pan to allow maximum circulation of air and to lift the food out of the fats and juices.
- Adjust the grid and grill pan runner position to allow for different thicknesses of food.
- Position the food close to the element for faster cooking and further away for gentler cooking.
- Food should be thoroughly dried before grilling to minimise splashing. Brush lean meats and fish lightly with a little oil or melted butter to keep them moist during cooking.
- Accompaniments such as tomatoes and mushrooms may be placed underneath the grid when grilling meats.
- When toasting bread, use the shelf in position 2 with the grid in the 'high' position.
- When using the centre section grill, ensure food is placed centrally on the grilling grid directly beneath the grill element.
- Preheat the grill on a full setting for a few minutes before sealing steaks or toasting. Adjust the heat setting and the shelf as necessary during cooking.
- The food should be turned over during cooking as required.

Hints and tips when using the top oven

- Arrange the shelves in the required positions before switching the oven ON. Shelf positions are counted from the bottom upwards.
- There should always be at least 2.5cm (1") between the top of the food and the element. This gives best cooking results and allows room for rise in yeast mixtures, Yorkshire puddings etc. When cooking cakes, pastry, scones bread etc., place the tins or baking trays centrally on the shelf.
- Ensure that food is placed centrally on the shelf and there is sufficient room around the baking tray/dish to allow for maximum circulation.
- Stand dishes on a suitably sized baking tray on the shelf to prevent spillage onto the oven base and to help reduce cleaning.
- The material and finish of the baking tray and dishes used affect base browning. Enamelware, dark, heavy or non-stick utensils increase base browning. Shiny aluminium or polished steel trays reflect the heat away and give less base browning.
- Because of the smaller cooking space and lower temperatures, shorter cooking times are sometimes required. Be guided by the recommendations given in the cooking chart.
- Do not place baking trays directly on the oven base as it interferes with the oven air circulation and can lead to base burning; use the lower shelf position.
- For economy leave the door open for the shortest possible time, particularly when placing food into a pre-heated oven.

Hints and tips when using main oven conventional cooking

- Single level cooking gives best results. If you require more than one level of cooking use the main fan oven.
- The middle shelf allows for the best heat distribution. To increase base browning simply lower the shelf position. To increase top browning raise, the shelf position.
- There should always be at least 2.5cm (1") between the top of the food and the grill element. This gives best cooking results and allows room for rise in yeast mixtures, Yorkshire puddings etc. When cooking cakes, pastry, scones bread etc., place the tins or baking trays centrally on the shelf.
- Ensure that food is placed centrally on the shelf and there is sufficient room around the baking tray or dish to allow for maximum circulation.

- Stand dishes on a suitably sized baking tray on the shelf to prevent spillage onto the oven base and to help reduce cleaning.
- The material and finish of the baking tray and dishes used will affect the degree of base browning. Enamelware, dark, heavy or non-stick utensils increase base browning. Shiny aluminium or polished steel trays reflect the heat away and give less base browning.
- Do not place baking trays directly on the oven base as it interferes with the oven air circulation and can lead to base burning; use the lower shelf position.
- For economy leave the door open for the shortest possible time, particularly when placing food into a pre-heated oven.

Hints and tips when using main oven fan cooking

- Arrange the shelves in the required positions before switching the oven on. Shelf positions are counted from the bottom upwards.

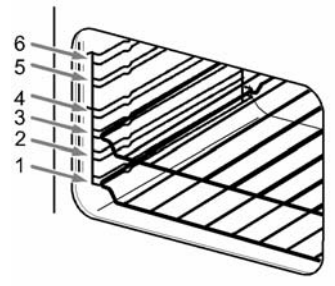

- When cooking more than one dish in the fan oven, place dishes centrally on different shelves rather than cluster several dishes on one shelf, this will allow the heat to circulate freely for the best cooking results.
- When batch baking one type of food, e.g. Victoria sandwich cakes, those of similar size will be cooked in the same time.
- It is recommended that when baking larger quantities the shelf positions should be evenly spaced to suit the load being cooked. A slight increase in cooking time may be necessary.
- Do not place baking trays directly on the oven base as it interferes with the oven air circulation and can lead to base burning; use the lower shelf position.

Hints and tips when turbo grilling

- Prepare foods in the same way as for conventional grilling. Brush lean meats and fish lightly with a little oil or butter to keep them moist during cooking.
- Most food should be placed on the grill pan grid in the 'high' position in the grill pan to allow maximum circulation of air around the food.
- Accompaniments such as tomatoes and mushrooms may be placed below the grid when grilling meats, or in a separate dish on a lower shelf.
- Foods will cook more quickly the closer they are to the grill element and the higher the temperatures selected. Be prepared to adjust temperatures and shelf positions during cooking if necessary.
- Turn food over during cooking as necessary.
- Ensure that ready prepared or cooked chilled dishes e.g. shepherds pie, moussaka, lasagne, etc., are piping hot throughout before serving.
- A temperature range of 140 - 220°C is suitable for most foods. Be prepared to make suitable adjustments during cooking to suit individual requirements. If Thermal grilling on more than one level, it may be necessary to interchange the food on the shelves during cooking.

Hints and tips when using pizza

- Single level cooking using the middle shelf position gives best results.
- Ensure that food is placed centrally on the shelf for maximum air circulation.
- Be guided by the cook times and temperatures given on any packaging.
- Some pizzas should be cooked directly on the oven shelf. To prevent soiling the oven base, place a baking tray in one of the lower shelf positions.
- The material and finish of the baking trays and dishes used will affect base browning. Enamelware, dark heavy or non-stick utensils increase base browning. Shiny aluminium or polished steel trays reflect the heat away and give less base browning.

Hints and tips when defrosting

- Place the frozen food in a single layer where possible and turn it over half way through the defrosting process.
- The actual speed of defrosting is influenced by room temperature. On warm days defrosting will be faster than on cooler days.
- It is preferable to thaw fish, meat and poultry slowly in the fridge. However, this process can be accelerated by using the defrost function. Small or thin fish fillets, frozen peeled prawns, cubed or minced meat, liver, thin chops, steaks etc., can be thawed in 1 – 2 hours.
- A 1kg/2¼lb oven ready chicken will be thawed in approximately 5 hours. Remove the giblets as soon as possible during the thawing process.
- Joints of meat up to 2kg/4½lb in weight can be thawed using the defrost function.
- All joints of meat and poultry must be thawed thoroughly before cooking.
- Always cook thoroughly immediately after thawing.
- Do not leave food at room temperature once it is defrosted. Cook raw food immediately or store cooked food in the fridge, once it has cooled.
- Care must always be taken when handling foods in the home. Always follow the basic rules of food hygiene to prevent bacterial growth and cross contamination when defrosting, preparing, cooking, cooling and freezing foods.

Maintenance and Cleaning

Warning

Before cleaning always allow the appliance to cool down before switching off at the electricity supply.

Cleaning materials

- Before using any cleaning materials on your appliance, check that they are suitable and that their use is recommended by the manufacturer.
- Cleaners that contain bleach should not be used as they may dull the surface finishes. Harsh abrasives and scourers should also be avoided.

External cleaning

- Do not use abrasive cleaning materials e.g. abrasive cream cleaners, wire wool pads or scourers on painted or printed finishes as damage may occur. Regularly wipe over the control panel, doors and appliance sides using a soft cloth and hot soapy water. To prevent streaking, finish with a soft cloth.
- Stainless Steel cream cleaners are abrasive and should be avoided as they may dull the surface finish. **Any spillage on the stainless steel finish must be wiped off immediately.**

Warning

Do not attempt to remove any of the control knobs from the appliance as this may cause damage and is a safety hazard.

Warning

Under no circumstances should the door assembly be detached from the product for cleaning.

Cleaning the control knobs and handles

It is strongly recommended that only hot soapy water be used for cleaning the control knobs and handles. **ANY OTHER CLEANING MATERIALS MAY DULL THE SURFACE FINISH.**

Cleaning the shelves, wirework runners and grill/oven furniture.

All removable parts, except the grill pan handle, can be washed in the dishwasher. The grill pan, grill pan grid, oven shelves and wirework runners may be cleaned using a soap impregnated steel wool pad. Soaking first in hot soapy water will make cleaning easier.

Removing and replacing the wirework runners

- Remove all shelves and furniture from the oven/grill cavities.
- Hold the wirework at the bottom, unclip from the cavity side and gently pull towards the centre of the oven/grill cavity.
- Unhook the runner at the top and remove from the cavity.
- To replace the runners, hook the wirework side runner into the cavity, slide back and press into place.

Warning

- Ensure the wirework runners are firmly in position before replacing the oven shelves.

Cleaning inside the ovens

- The Stayclean surface inside the ovens should not be cleaned manually. See 'Care of Stayclean Surfaces'. The vitreous enamel main oven base and grill compartment base can be cleaned using normal oven cleaners with care. Ensure that the manufacturers instructions are followed and that all parts are well rinsed afterwards.

Warning

Aerosol cleaners must not be used on Stayclean surfaces and must not come into contact with the elements, the door seal or any painted finishes as this may cause damage.

Care of stayclean surfaces

- To carry out the cleaning cycle, remove the oven shelves and set the oven to 220°C.
- It is a good idea to run the oven for an hour or two per week to ensure continued good performance from the Stayclean finish.
- Slight discolouration and polishing of the Stayclean surfaces may occur in time. This does not affect the Stayclean properties in any way.
- Use minimal, if any, extra oil or fat when roasting meat, potatoes only require brushing with fat before cooking. Extra fat in the oven during roasting will increase splashing and staining of the cavity.
- It is not necessary to add water to a meat tin when roasting. The water and the fat juices from the joint create excessive splattering during cooking – even at normal temperatures, as well as causing condensation.
- Covering joints during cooking will also prevent splashing onto the interior surfaces. Removing the covering for the last 20-30 minutes will allow extra browning if required. Some large joints and turkeys especially benefit by this method of cooking, allowing the joint to cook through before the outside is over-browned.

Replacing an oven light bulb (main oven)

- The type of bulb required is a 300°C 25 watt small Edison Screw.

Warning

Disconnect the appliance from the electricity supply before replacing the bulb.

- Make sure the appliance is cool before replacing the bulb.
- Open the door and remove the shelves and wirework runners.
- Insert a flat blade screwdriver between the oven side and glass, which covers the bulb.
- Support the glass with your hand and prise out sufficiently to release the glass cover.
- Unscrew the bulb in an anti-clockwise direction until it is possible to remove the bulb with ease.
- Fit the new bulb by turning in a clockwise direction until it is secure.
- Ensuring the indent to the flange is pointing to the rear of the oven, replace the glass by pushing it firmly into the hole to cover the bulb assembly.
- Replace the shelves and wirework runners.
- Restore the electricity supply and adjust the time of day and clock as necessary.

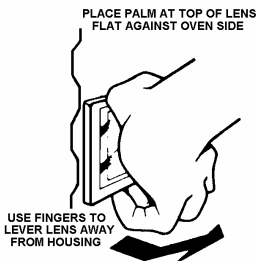

How to replace the oven light (top oven)

- The type of bulb required is a 300°C 25 watt small Edison Screw.

Warning

Disconnect the appliance from the electricity supply before replacing the bulb.

- Make sure the appliance is cool before replacing a bulb.
- Open the door and remove the shelves and wirework runners.
- Remove the glass cover by turning it to the left.
- Unscrew the bulb by turning it to the left.
- Fit a new bulb and then replace the glass bulb cover.
- Refit the wirework runners and replace the oven shelves.
- Restore the electricity supply and reset the time of day.

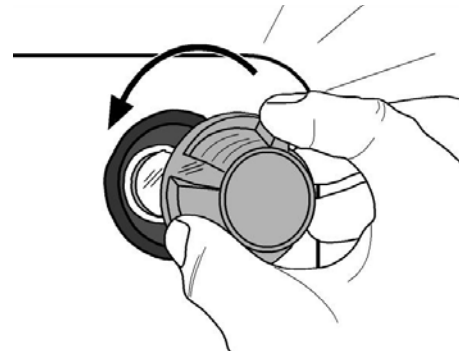

Cleaning the doors

Warning

Under no circumstances should the door assembly be detached from the product for cleaning. Please refer to the cleaning instructions.

Warning

To prevent damaging or weakening the door glass panels avoid the use of the following:

- Household detergents and bleaches
- Soap impregnated pads unsuitable for non-stick saucepans
- Abrasive cleaning pads, scourers and steel wool pads.
- Chemical oven pads or aerosols
- Rust removers
- Bath/Sink stain removers

How to remove the inner door glass

1. Open the oven door slightly to gain access to the two cross head screws on the top of the oven door.
2. Loosen the two screws using a Pozidrive screwdriver.
3. Holding the door glass securely in place with one hand remove the screws and washers with the other hand. The screws and washers retain the trim on the top of the grill door. Note the position of the trim on the door.

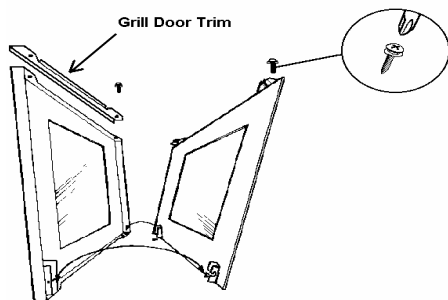

4. Holding the door and glass with one hand, gently pull towards you and slightly lift the door glass with the other hand to disengage the panel from the location point at the bottom of the door. Gently release the door to close it.
5. Clean the outer and inner glass using hot soapy water or hob cleaner should the inner face of the outer door glass be heavily soiled it is recommended that soapy water with a high concentration of soap is used. To prevent streaking a glass cleaning spray may be applied and the glass polished with a soft cloth. Ensure that all parts are thoroughly dry before attempting to replace the outer door glass.

Warning

If the door glass panel becomes chipped or has deep scratches the glass will be weakened and must be replaced to prevent the possibility of the panel shattering. Please contact your local Service Force Centre who will be pleased to advise further.

How to replace the inner door glass

1. Holding the oven glass with both hands, gently place the locators into the holes of the brackets at the bottom of the oven door.
2. Holding the door glass with your left hand, use your right hand to open the oven door.
3. Bring the door gently towards the glass panel ensuring the screw location holes line up.
4. Place the trim in the correct position on the top of the grill door.
5. Hold the glass in place with one hand and insert the cross head screws with washers into the location holes with the other hand. Give the screws one turn to ensure the glass is secure.

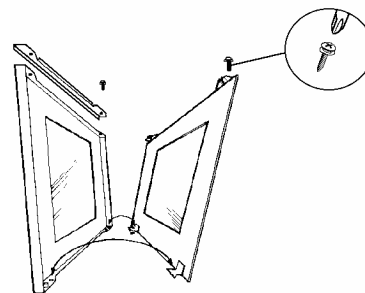

6. Tighten the screws positively with a Pozidrive screwdriver before closing the oven door.

Warning

Do not attempt to use the oven without the glass being in place.

Something Not Working

If the oven is not working correctly, please carry out the following checks, before contacting your local Service Force repair agent.

In the event of any other fault codes that arise, disconnect the appliance from the electrical supply for a few seconds (take out the fuse from the housing wiring system). If the fault code is displayed again, please call your local Service Force repair agent and report the fault code.

IMPORTANT: If you call out an engineer to a fault listed below, or to repair a fault caused by incorrect use or installation, a charge will be made even if the appliance is under guarantee.

PROBLEM	POSSIBLE SOLUTION
The grill, ovens and timer do not work.	Check that the appliance has been wired in to the appliance supply and is switched on at the wall. Check that the main appliance fuse is working.
The grill works but the main oven does not.	If you have checked the above: Allow the appliance to cool for a couple of hours. The appliance should now be working normally. Check that the grill control is in the OFF position.
The grill and top oven work but the main oven does not.	Switch OFF at the wall to allow the oven to cool. Check that the oven is now working normally. Check that the time of day has been set on the clock. Check that the oven is set for manual cooking.
The grill does not work or cuts out after being used for a long period of time.	Ensure the cooling fan is running when the grill is on. If the cooling fan fails, the grill will not operate correctly. Contact your local service force centre. Leave the grill door open and allow the grill to cool. After a couple of hours check that the grill works as normal.
The timer does not work.	Check that the instructions for the operation of the timer are being closely followed.
The indicator neons are not working correctly.	Check that you have selected only the function you require. Ensure all other controls are in the off position.
The oven is not cooking evenly.	Check that the appliance is correctly installed and is level. Check that the recommended temperatures and shelf positions are being used.
The oven light fails to illuminate.	The oven light bulb may need replacing. If the Main Oven is set for automatic cooking the light will illuminate when the cook time begins.
The oven fan is noisy.	Check that the oven is level. Check that the shelves and bake ware are not vibrating in contact with the oven back panel.
The oven temperature is too high or too low.	Check that the recommended temperatures and shelf positions are being used. Be prepared to adjust the temperature up or down slightly to achieve the results you want.

Repairs - After sales service

If your oven is not performing satisfactorily; consult the fault finding guides within this instruction book (Something not working). If a fault occurs which you can not resolve through following the advice and information contained within this instruction manual, the next step is to contact our extended warranty administrators on

0870 010 7887

They will give you details for your local Service Force Centre.

Before calling out an engineer, please ensure you have read the details under the heading "Something Not Working". When you contact your local Service Force Centre you will need to give the following details:

1. Your name, address and post code
2. Your telephone number
3. Clear and concise details of fault
4. The purchase date as found on your receipt
5. The model and serial number of the appliance (found on the rating plate) So that you always have these numbers at hand, we recommend you to make a note of them here:

Mod. :

PNC. :

S.N. :

Your oven is covered by a 3 year parts and labour guarantee (see separate details given at point of sale).

Please retain your purchase receipt safely for the service engineer to verify the purchase details



Spare parts

This oven should be serviced by any authorised service engineer; and only genuine spare parts should be used. Under no circumstances should you attempt to repair the oven yourself.

Repairs carried out by inexperienced persons may cause injury or serious malfunctioning. Contact our extended warranty administrators on

0870 010 7887

who will give you details for your Service Force repair agent. Always insist on genuine spare parts.

	Manufacturer	JOHN LEWIS	
	Model Number	JLBIDOS906	
Top Oven	Energy Efficiency on a Scale A (more efficient) to G (less efficient) (4)		
	Energy Consumption in kWh (1)	Conventional	0.72
		Forced air Convection	
	Useable Volume - Litres	3 l	
	Oven Size (2)	Small	
	Time Taken to 'Cook' Standard Load - Minutes	Conventional	40
		Forced air Convection	
The Area of the largest Baking Sheet -cm ² (3)	1470		
Bottom Oven	Energy Efficiency on a Scale A (more efficient) to G (less efficient) (5)		
	Energy Consumption in kWh (1)	Conventional	0.88
		Forced air Convection	
	Useable Volume - Litres	53	
	Oven Size (2)	Medium	
	Time Taken to 'Cook' Standard Load - Minutes	Conventional	42
		Forced air Convection	50
The Area of the largest Baking Sheet -cm ² (3)	1470		

- (1) Based on test results for a standard load in accordance with EN50304
(2) Small: 12l<35l Medium: 35l<65l Large: 65l+
(3) Surface Area of Shelf
(4) Conventional Function unless stated
(5) Forced Air Convection Function unless stated

John Lewis Partnership

171 Victoria Street
London SW1E 5NN

www.johnlewis.com

Free Manuals Download Website

<http://myh66.com>

<http://usermanuals.us>

<http://www.somanuals.com>

<http://www.4manuals.cc>

<http://www.manual-lib.com>

<http://www.404manual.com>

<http://www.luxmanual.com>

<http://aubethermostatmanual.com>

Golf course search by state

<http://golfingnear.com>

Email search by domain

<http://emailbydomain.com>

Auto manuals search

<http://auto.somanuals.com>

TV manuals search

<http://tv.somanuals.com>